



Italian Society of Chemistry
Division of Organic Chemistry
Division of Medicinal Chemistry
Division of Mass Spectrometry

TARGETS IN HETEROCYCLIC SYSTEMS

Chemistry and Properties

Volume 15 (2011)

Reviews and Accounts on Heterocyclic Chemistry
http://www.soc.chim.it/it/libriecollane/target_hs

Editors

Prof. Orazio A. Attanasi
University of Urbino “Carlo Bo”, Urbino, Italy

and

Prof. Domenico Spinelli
University of Bologna, Bologna, Italy

Published by:

Società Chimica Italiana

Viale Liegi, 48

00198 Roma

Italy

Copyright © 2011 Società Chimica Italiana

All rights reserved. No part of this publication may be reproduced, stored in a retrieval system or transmitted in any form or by any means (electronic, electrostatic, magnetic tape, mechanical, photocopying, recording or otherwise) without permission in writing from the publishers. A person may photocopy an article for personal use.

Volume 1 (1997)	First edition 1997	ISBN 88-86208-24-3	
	Second edition 1999	ISBN 88-86208-24-3	
Volume 2 (1998)	First edition 1999	ISBN 88-86208-11-1	
Volume 3 (1999)	First edition 2000	ISBN 88-86208-13-8	
Volume 4 (2000)	First edition 2001	ISBN 88-86208-16-2	
Volume 5 (2001)	First edition 2002	ISBN 88-86208-19-7	
Volume 6 (2002)	First edition 2003	ISBN 88-86208-23-5	
Volume 7 (2003)	First edition 2004	ISBN 88-86208-28-6	ISSN 1724-9449
Volume 8 (2004)	First edition 2005	ISBN 88 86208-29-4	ISSN 1724-9449
Volume 9 (2005)	First edition 2006	ISBN 88 86208-31-6	ISSN 1724-9449
Volume 10 (2006)	First edition 2007	ISBN 978-88-86208-51-2	ISSN 1724-9449
Volume 11 (2007)	First edition 2008	ISBN 978-88-86208-52-9	ISSN 1724-9449
Volume 12 (2008)	First edition 2009	ISBN 978-88-86208-56-7	ISSN 1724-9449
Volume 13 (2009)	First edition 2010	ISBN 978-88-86208-62-8	ISSN 1724-9449
Volume 14 (2010)	First edition 2011	ISBN 978-88-86208-67-3	ISSN 1724-9449
Volume 15 (2011)	First edition 2012	ISBN ISSN	ISSN 1724-9449

Printed and bound in Italy by:

Arti Grafiche Editoriali s.r.l.

Via S. Donato, 148/C

61029 Urbino (Pesaro-Urbino)

Italy

May 2012

Editorial Advisory Board Members

Prof. Enrico Aiello
University of Palermo
Palermo, Italy

Prof. Jan Bergman
Karolinska Institute
Huddinge, Sweden

Prof. Robert K. Boeckman Jr.
University of Rochester
Rochester, USA

Prof. José A. S. Cavaleiro
University of Aveiro
Aveiro, Portugal

Prof. Leopoldo Ceraulo
University of Palermo
Palermo, Italy

Prof. Janine Cossy
ESPCI
Paris, France

Dr. Daniele Donati
Glaxo Wellcome
Verona, Italy

Prof. José Elguero
CSIC
Madrid, Spain

Prof. Dieter Enders
RWTH
Aachen, Germany

Prof. Leon Ghosez
Catholic University of Louvain
Louvain la Neuve, Belgium

Prof. Gianluca Giorgi
University of Siena
Siena, Italy

Prof. Lucedio Greci
University of Ancona
Ancona, Italy

Prof. Laurence M. Harwood
University of Reading
Reading, UK

Prof. Victor G. Kartsev
InterBioScreen Ltd
Moscow, Russia

Prof. Steven V. Ley
University of Cambridge
Cambridge, UK

Prof. Alexander McKillop
University of East Anglia
Norwich, UK

Prof. Giovanni Sindona
University of Calabria
Arcavacata di Rende, Italy

Prof. Branko Stanovnik
University of Ljubljana
Ljubljana, Slovenia

Prof. Richard J. K. Taylor
University of York
York, UK

Prof. Eric J. Thomas
University of Manchester
Manchester, UK

Indexed/Abstracted in: Chemical Abstracts; Current Contents; ISI/ISTP&B online database; Index to Scientific Book Contents; Chemistry Citation Index; Current Book Contents; Physical, Chemical & Earth Sciences; Methods in Organic Synthesis; The Journal of Organic Chemistry; La Chimica e l'Industria; Synthesis.

Preface

Heterocyclic derivatives are important in organic chemistry as products (including natural) and/or useful tools in the construction of more complicated molecular entities. Their utilization in polymeric, medicinal and agricultural chemistry is widely documented. Both dyestuff and tanning structures, as well as life molecules frequently involve heterocyclic rings that play an important role in several chemical and biochemical processes.

Volume 15 (2011) keeps the international standard of THS series and contains eleven chapters, covering the synthesis, reactivity, and activity (including medicinal) of different heterorings. Authors from France, Germany, Greece, India, Italy, Maroc, Moldova, Poland, Russia, Slovakia and Spain are present in this book.

As yet, THS Volumes 1-15 published 209 reviews by 574 authors from 29 different countries for a total of 6.400 pages.

Comprehensive Reviews reporting the overall state of the art on wide fields as well as personal Accounts highlighting significant advances by research groups dealing with their specific themes have been solicited from leading Authors. The submission of articles having the above-mentioned aims and concerning highly specialistic topics is strongly urged. The publication of Chapters in THS is free of charge. Firstly a brief layout of the contribution proposed, and then the subsequent manuscript, may be forwarded either to a Member of the Editorial Board or to one of the Editors.

The Authors, who contributed most competently to the realization of this Volume, and the Referees, who cooperated unselfishly (often with great patience) spending valuable attention and time in the review of the manuscripts, are gratefully acknowledged.

The Editors thank very much Dr. Lucia De Crescentini for her precious help in the editorial revision of the book.

Orazio A. Attanasi and Domenico Spinelli

Editors

Table of Contents

(for the contents of Volumes 1–14 please visit: <http://www.soc.chim.it>)

Angle-strained heterocyclic alkynes with five to ten ring atoms

1

Heiner Detert

1. Introduction
 - 1.1. Cycloalkynes
 - 1.2. Consequences of ring strain on chemical properties
 - 1.3. Ring strain and spectroscopy
 2. Cyclopentynes
 3. Cyclohexynes
 4. Cycloheptynes
 - 4.1. Oxacycloheptynes and azacycloheptynes
 - 4.2. Thiacycloheptynes
 - 4.3. Silacycloheptynes
 - 4.4. Polysilacycloheptynes
 5. Cyclooctynes
 - 5.1. Oxacyclooctynes
 - 5.2. Azacyclooctynes
 - 5.3. Thiacyclooctynes
 - 5.4. Silacyclooctynes
 6. Cyclononynes
 - 6.1. Oxacyclononynes
 - 6.2. Azacyclononynes
 - 6.3. Thiacyclononynes
 - 6.4. Silacyclononynes
 - 6.5. Pericyclynes
 7. Cyclodecynes
 - 7.1. Oxacyclodecynes and azacyclodecynes
 - 7.2. Thiacyclodecynes
 - 7.3. 1,6-Diheterocyclodeca-3,8-diynes
 - 7.4. Sila- and germacyclodecynes
 8. Conclusion
- References

An overview on the synthesis of sugar imino acids

50

Raquel G. Soengas and Amalia Estévez

1. Introduction
2. Six-membered ring sugar imino acids
 - 2.1. Polyhydroxylated derivatives of pipercolic acid
 - 2.1.1. 3,4,5-Trihydroxypipercolic acids

- 2.1.2. Other hydroxylated derivatives of pipercolic acid
 - 2.2. Polyhydroxylated piperidinic β -amino acids: aza-analogues of glucuronic acid
 - 2.3. Polyhydroxylated derivatives of isonipecotic acid
 - 3. Five-membered ring sugar imino acids
 - 3.1. Bulgecinine
 - 3.2. Trihydroxyproline derivatives
 - 4. Conclusions
- Acknowledgments
- References

Recent advances in gold catalyzed inter- and intramolecular functionalization of heteroaromatic compounds

86

Monica Dell'Acqua, Diego Facoetti, Valentina Pirovano, Giorgio Abbiati and Elisabetta Rossi

- 1. Introduction
 - 2. Gold catalyzed Friedel-Crafts type reactions
 - 3. Hydroheteroarylation of C=O bonds
 - 4. Hydroheteroarylation of carbon-carbon multiple bonds
 - 4.1. Hydroheteroarylation of activated alkenes and alkynes
 - 4.2. Hydroheteroarylation of unactivated alkenes
 - 4.3. Hydroheteroarylation of allenes
 - 4.4. Hydroheteroarylation of unactivated alkynes
 - 5. Direct alkynylations
 - 6. Reactions involving rearrangement
 - 7. Domino reactions
 - 8. Concluding remarks
- References

Stereoselective multicomponent reactions: from simple 1,3-dicarbonyls to functionalized chiral heterocycles

140

Damien Bonne, Yoann Coquerel, Thierry Constantieux and Jean Rodriguez

- 1. Introduction
- 2. Diastereoselective multicomponent reactions
 - 2.1. MCRs based on the Hantzsch reaction
 - 2.2. MCRs based on the Biginelli reaction
 - 2.3. MCRs based on the Mannich reaction
 - 2.4. MCRs based on the Knoevenagel reaction
 - 2.5. MCRs based on the Michael addition
 - 2.6. MCRs based on Wolff rearrangement
- 3. Enantioselective multicomponent reactions
- 4. Conclusion

Acknowledgments

References

Chemical synthesis of five-membered nitrogen heterocycles by reductive cyclization methods

164

Tomás Tejero, Pedro Merino, Ignacio Delso and David Sadaba

1. Introduction
2. Synthesis of five-membered nitrogen heterocycles from γ -nitrocarbonyl compounds
 - 2.1. Hydrogenation
 - 2.1.1. Catalyzed by Raney nickel
 - 2.1.2. Catalyzed by palladium
 - 2.1.3. Catalytic hydrogen transfer reactions
 - 2.2. Reduction with $\text{NiCl}_2/\text{NaBH}_4$
 - 2.3. Reduction with $\text{Zn}/\text{Brønsted}$ acid system
 - 2.4. Reduction with $\text{Fe}/\text{Brønsted}$ acid system
 - 2.5. Reduction with TiCl_3
 - 2.6. Reduction with SnCl_2
3. Synthesis of five-membered nitrogen heterocycles from β -cyanocarbonyl compounds
 - 3.1. Hydrogenation
 - 3.1.1. Catalyzed by Raney nickel
 - 3.1.2. Catalyzed by platinum oxide
 - 3.1.3. Catalyzed by palladium
 - 3.1.4. Catalyzed by rhodium
 - 3.2. Reduction with $\text{NiCl}_2/\text{NaBH}_4$
 - 3.3. Reduction with $\text{CoCl}_2/\text{NaBH}_4$
 - 3.4. Reduction with LiAlH_4
4. Concluding remarks

Acknowledgments

References

Palladium-catalyzed amination reaction in the synthesis of nitrogen- and oxygen-containing macrocycles and macropolycycles

193

Alexei D. Averin, Sergei M. Kobelev, Maksim V. Anokhin, Alla G. Bessmertnykh Lemeune, Roger Guilard and Irina P. Beletskaya

1. Introduction
2. Macrocycles comprising aryl moieties
 - 2.1. Macrocycles based on 1,2- and 1,3-disubstituted benzenes
 - 2.2. Macrocycles with biphenyl units
 - 2.3. Naphthalene-based macrocycles
 - 2.4. Macrocycles comprising anthracene and anthraquinone fragments
3. Macrocycles containing heteroaryl moieties

- 3.1. Pyridine-based macrocycles
- 3.2. 2,2'-Bipyridine-containing macrocycles
- 3.3. Macrocycles with pyrimidine units
- 4. Macrocycles incorporating adamantane fragment
- 5. Macrocyclic derivatives of cholane diol
- 6. Macropolycyclic compounds
 - 6.1. Macrobi- and macrotricycles derived from substituted cyclen and cyclam
 - 6.2. Macropolycyclic derivatives of azacrown ethers
 - 6.3. Macrobicycles based on disubstituted biphenyl and naphthalene
- 7. Applications of the macrocycles for metal ions detection
- 8. Conclusions
- Acknowledgments
- References

Metal-catalyzed intramolecular hydroaminations of unsaturated amines with terminal double bond – Part 1

226

František Mathia, Peter Zálupský and Peter Szolcsányi

- 1. Introduction
 - 1.1. Hydroamination
- 2. Overview of hydroamination catalysts
 - 2.1. Group I and IIA metals
 - 2.1.1. Synthesis of pyrrolidines
 - 2.1.2. Synthesis of piperidines
 - 2.2. Lanthanides and actinides
 - 2.2.1. Synthesis of pyrrolidines
 - 2.2.2. Synthesis of piperidines and azepanes
- 3. Summary
- Acknowledgments
- References

3,4-Ethylenedioxythiophene (EDOT), an outstanding building block. Synthesis and functionalization

263

María José Mancheño, Alejandro de la Peña and José L. Segura

- 1. Introduction
- 2. Synthesis of EDOT
- 3. EDOT functionalization. New derivatives containing the EDOT unit
 - 3.1. Modifications in the ethylene bridge of EDOT
 - 3.2. Basic reactions in the thiophene moiety of EDOT
 - 3.2.1. EDOT-based oligothiophenyl chalcogenides
 - 3.2.2. EDOT derivatives *via* cross-coupling reactions

3.2.1.1. *Via Stille cross-coupling reaction*

3.2.2.2. *Other cross-coupling reactions*

3.2.3. *EDOT derivatives via Wittig-Horner-Emmons reactions*

4. *Conclusions*

Acknowledgments

References

Recent application of isatins in synthesis of functionalized spirocyclic oxindoles

294

Fliur Macaev, Athina Geronikaki and Natalia Sucman

1. *Introduction*

2. *Structure and occurrence*

3. *Three-membered spirooxindoles*

3.1. *Cycloaddition*

3.1.1. *Catalysts free*

3.1.2. *Metal catalysis*

3.1.3. *Organocatalysis*

3.1.4. *Ylide approach*

3.2. *Ring closing*

4. *Four-membered spirooxindoles*

5. *Five-membered spirooxindoles*

5.1. *Cycloaddition*

5.1.1. *Dipolar additions*

5.1.2. *Metal catalysis*

5.1.3. *Organocatalysis*

5.1.4. *Catalysts free*

6. *Six-membered spirooxindoles*

6.1. *Cycloaddition*

6.1.1. *Lewis base or acid catalysts*

6.1.2. *Organocatalysis*

6.2. *Ring closing*

7. *Seven-membered spirooxindoles*

8. *Biological activity of discussed spirocyclic oxindoles*

9. *Conclusions*

Acknowledgments

References

Recent advances in microwave-assisted heterocyclic chemistry.

327

Synthesis of three, four and five-membered heterocycles

Mohsine Driowya, Khalid Bougrin and Rachid Benhida

1. *Introduction*

2. Heterocycles synthesis

2.1. Three-membered heterocycles with one heteroatom

2.1.1. Aziridines

2.1.2. Oxiranes

2.1.3. Thiiranes

2.2. Four-membered heterocycles with one heteroatom

2.2.1. β -Lactams

2.3. Five-membered heterocycles with one heteroatom

2.3.1. Pyrroles, thiophenes and furanes

2.3.2. Indoles, benzofurans and benzothiophenes

2.4. Five-membered heterocycles with two heteroatoms

2.4.1. Imidazoles

2.4.2. Pyrazoles

2.4.3. Oxazoles and isoxazoles

2.4.4. Thiazoles

2.4.5. Benzimidazoles, benzoxazoles and benzothiazoles

2.5. Five-membered heterocycles with three heteroatoms

2.5.1. Triazoles

2.5.1.1. Synthesis of 1,2,3-triazoles

2.5.1.1.1. Synthesis using Cu^{II} salts

2.5.1.1.2. Synthesis using Cu^{I} salts

2.5.1.1.3. Synthesis using Cu^0 and Cu^{II}

2.5.1.1.4. Other methods for the synthesis of 1,2,3-triazoles

2.5.1.2. Synthesis of 1,2,4-triazoles

2.5.2. Oxadiazoles and thiadiazoles

2.6. Five-membered heterocycles with four heteroatoms

2.6.1. Tetrazoles

3. Conclusion

Acknowledgments

References

Félix Rodríguez and Francisco J. Fañanás

1. Introduction
 2. Mechanism and general aspects of the metal-catalyzed electrophilic cyclization
 3. Oxygen-centred nucleophiles
 - 3.1. Cyclization of alcohols
 - 3.1.1. Intramolecular addition to alkynes
 - 3.1.2. Intramolecular addition to alkenes
 - 3.1.3. Intramolecular addition to allenes
 - 3.2. Cyclization of carboxylic acids
 - 3.2.1. Intramolecular addition to alkynes
 - 3.2.2. Intramolecular addition to alkenes
 - 3.2.3. Intramolecular addition to allenes
 - 3.3. Cyclization of amides, carbonates and carbamates
 - 3.4. Cyclization of aldehydes and ketones
 - 3.4.1. Intramolecular addition to alkynes
 - 3.4.2. Intramolecular addition to allenes
 - 3.5. Cyclization of ethers and acetals. Intramolecular addition to alkynes
 4. Nitrogen-centred nucleophiles
 - 4.1. Cyclization of amines
 - 4.1.1. Intramolecular addition to alkynes
 - 4.1.2. Intramolecular addition to alkenes
 - 4.1.3. Intramolecular addition to allenes
 - 4.2. Cyclization of amides, carbamates and trichloroacetimidates
 - 4.2.1. Intramolecular addition to alkynes
 - 4.2.2. Intramolecular addition to allenes
 - 4.3. Cyclization of imines
 5. Cascade reactions initiated by a metal-catalyzed electrophilic cyclization
 6. Conclusions
- Acknowledgments
- References

Giorgio Chelucci

1. Introduction
2. Pyridyl *sec*-alcohols
 - 2.1. Addition of 2-pyridyllithium derivatives to chiral aldehydes
 - 2.2. Addition of chiral 2-pyridyllithium derivatives to aldehydes
 - 2.3. Stereoselective addition of organometallic reagents to pyridyl carboxaldehydes

- 2.3.1. Enantioselective addition
- 2.3.2. Diastereoselective addition
- 2.4. Rearrangement of pyridine *N*-oxides
- 2.5. Reduction of pyridyl ketones
 - 2.5.1. Stoichiometric enantioselective reduction
 - 2.5.2. Catalytic enantioselective reduction
 - 2.5.2.1. Borane reduction
 - 2.5.2.2. Hydrogenation transfer reactions
 - 2.5.2.3. Hydrogenation
 - 2.5.3. Stoichiometric diastereoselective reduction
 - 2.5.4. Catalytic diastereoselective reduction
- 2.6. Cyclotrimerization of chiral 2-hydroxynitriles
- 2.7. Asymmetric dihydroxylation
- 2.8. Chiral aziridine and epoxide ring opening
- 3. Conclusion
- 4. Note added in proof
- Acknowledgments
- References

ANGLE-STRAINED HETEROCYCLIC ALKYNES WITH FIVE TO TEN RING ATOMS

Heiner Detert

*Institut für Organische Chemie, Johannes Gutenberg-Universität Mainz, Duesbergweg 10–14,
D-55128 Mainz, Germany (e-mail: detert@uni-mainz.de)*

Abstract. *Heterocycloalkynes with five to ten ring atoms including one or more heteroatoms in the ring are the subject of this review. Synthetic methods and chemical reactivity are reported. Ring strain results in distortion of the alkyne unit, visible in spectroscopy as well as in an enhanced reactivity of the triple bond. The ring strain of a carbocyclic alkyne increases upon exchange of carbon with oxygen or nitrogen whereas sulfur or silicon result in a release from ring strain. Strained heterocyclic alkynes had been proposed as intermediates in reaction mechanisms, thereafter, they became a fertile subject of physical organic chemistry and spectroscopy. Nowadays, they are in the focus as reactive units for bioconjugation in life science and as DNA cleaving agents.*

Contents

1. Introduction
 - 1.1. Cycloalkynes
 - 1.2. Consequences of ring strain on chemical properties
 - 1.3. Ring strain and spectroscopy
2. Cyclopentynes
3. Cyclohexynes
4. Cycloheptynes
 - 4.1. Oxacycloheptynes and azacycloheptynes
 - 4.2. Thiacycloheptynes
 - 4.3. Silacycloheptynes
 - 4.4. Polysilacycloheptynes
5. Cyclooctynes
 - 5.1. Oxacyclooctynes
 - 5.2. Azacyclooctynes
 - 5.3. Thiacyclooctynes
 - 5.4. Silacyclooctynes
6. Cyclononynes
 - 6.1. Oxacyclononynes
 - 6.2. Azacyclononynes
 - 6.3. Thiacyclononynes
 - 6.4. Silacyclononynes
 - 6.5. Pericyclynes
7. Cyclodecynes
 - 7.1. Oxacyclodecynes and azacyclodecynes

- 7.2. Thiacyclodecyne
- 7.3. 1,6-Diheterocyclodeca-3,8-diyne
- 7.4. Sila- and germacyclodecyne

8. Conclusion

References

1. Introduction

1.1. Cycloalkynes

A strain-free triple bond requires four linearly arranged atoms; in carbocyclic systems, this geometry is nearly fulfilled in cycloundecyne and higher homologues. Cyclic alkynes of smaller ring size have been under debate for more than a century. The first carbocyclic alkyne, cycloheptadecyne, had been prepared by Ruzicka¹ in 1933 and 20 years passed until Blomquist² succeeded in the synthesis of cyclodecyne, the first strained carbocyclic alkyne. Nevertheless, the first report of a cyclic alkyne dates back to 1929 when Lespieau³ described 1,6-dioxacyclodeca-3,8-diyne. Cycloalkynes have been a highly interesting topic for structure-property relationships in spectroscopy, mechanistic and physical organic chemistry and a whetstone for synthetic chemists. All these facets have been collected in several reviews.^{4–11} Whereas the carbocyclic systems are generally in the focus of these reviews, a survey of the heterocyclic systems will be given here. The paper is organized according to increasing ring size from five to ten ring atoms, and the heteroatoms in the ring. The general sequence is O, N, S and Si; systems with other heteroatoms appear only occasionally.

1.2. Consequences of ring strain on chemical properties

Bending of the triple bond is the general effect of ring strain in cycloalkynes. The distorted alkyne unit is significantly more reactive than a linear acetylene, most important are 1,2-additions. These can be observed with nucleophiles, electrophiles and free radicals; cycloadditions of the types [2+1], [2+2], [2+3], [2+4], [2+2+2] and [2+8] occur. The typical feature of medium-sized rings, transannular reactions after attack of an electrophile, adds to the fascination of these compounds. Heteroatoms in the ring affect ring strain and reactivity significantly. As standard bond lengths¹² decrease in the order C–Si (1.87 Å), C–S (1.83 Å), C–C (1.54 Å), C–N (1.47 Å) and C–O (1.43 Å), the deformation – and therefore the reactivity – of the alkyne depends on the heteroatom. Furthermore, the electronegativity of the heteroatom polarizes the triple bond and this effect is well known for alkynyl ethers and ynamines, units that do not appear in isolable strained cycloalkynes. Nevertheless, polarization tunes the reactivity of the triple bond in propargylic ethers and amines, and even sulfur polarizes the triple bond, in propargylic systems and most prominent, in alkynyl thioethers. Additionally, a sulfur atom in the ring can be the site for electrophilic transannular reactions, which are a central chemical consequence in heterocyclodeca-1,6-diyne.

1.3. Ring strain and spectroscopy

sp-Hybridization determines the linear geometry of the C≡C triple bond and the adjacent atoms. In cycloalkynes, ring strain causes bending of this unit. This provokes a rehybridization of the acetylenic carbons from *sp* towards *sp*², which reduces the strength of this bond. Another effect of bending the triple bond is removal of the degeneracy of the two π -orbitals, as it has been found in photoelectron spectroscopy.

The close proximity of the parallel triple bonds in cyclodeca-1,6-diyne allows an electronic through-space interaction of the alkynes. Though spectroscopic implications of the deformation of the alkyne have been found by several methods, only IR, Raman and ^{13}C -NMR data have been reported for the majority of heterocyclic alkynes.

2. Cyclopentynes

Didehydrobenzofurane **1** had been postulated as an intermediate already in 1902.¹³ Only after 60 years, Wittig¹⁴ could prove the existence of this aryne by trapping it with tetracyclone **4** (Scheme 1).

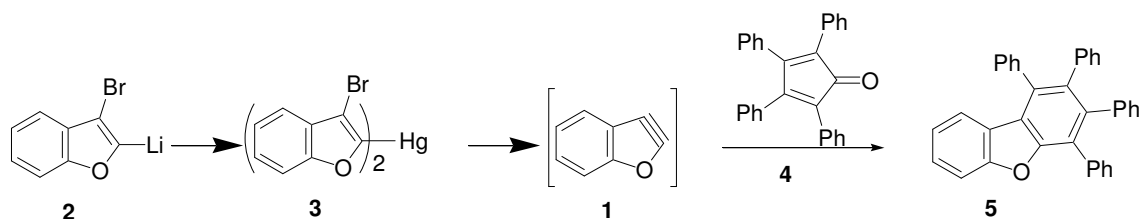

Scheme 1. Generation and trapping of didehydrobenzofurane (**1**).

The relatively stable 2-lithio-3-bromobenzofuran **2** was mercurated to **3** and upon heating in the presence of **4**, tetraphenyldibenzofuran **5** was formed in 70% yield. This route was also used to generate 2,3-didehydro-thiophene **7**, that gave isolated cycloadduct **8** (Scheme 2).¹⁵ The same conditions applied to the isomeric compound **9** gave the same cycloadduct **8** – probably by initial generation of a 3,4-didehydro-thiophene **11** and isomerization of this cumulene to the aryne **7** followed by Diels-Alder reaction and elimination of carbon monoxide. Several trapping experiments demonstrated that this five-membered hetaryne is almost certainly formed in the flash vacuum pyrolysis of thiophene-2,3-dicarboxylic acid anhydride.¹⁶

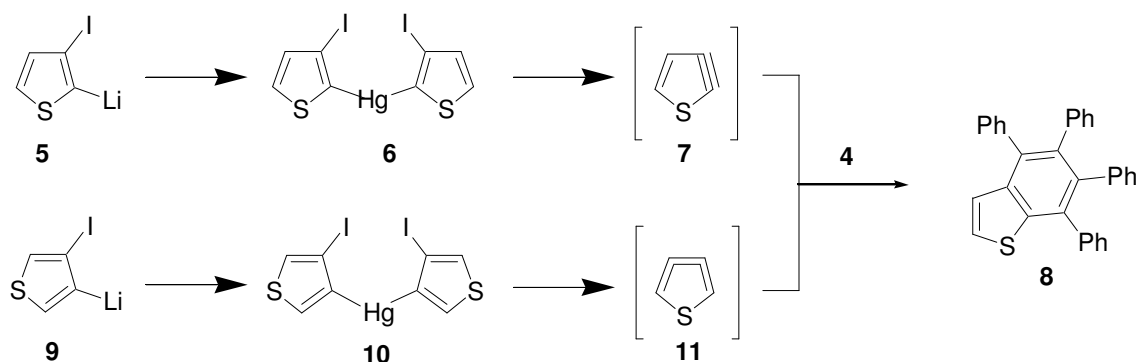

Scheme 2. Generation and trapping of 2,3-thiophyne **7**.

Except for the alkynes discussed above, 2,2,5,5-tetramethylthiacyclopent-3-yne **13** is probably up to now the smallest heterocyclic alkyne ever observed (Scheme 3).¹⁷

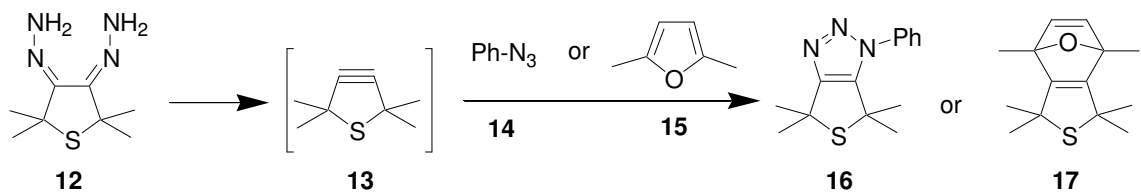

Scheme 3. Formation of thiacyclopent-3-yne **13** via oxidation of the bishydrazone and trapping.

Compared to cyclopentyne the ring strain in **13** should be lower owing to the longer carbon sulfur bonds and the methyl groups should sterically shield the reactive triple bond. Compound **13** was prepared by oxidation of the vicinal bishydrazone **12** with $\text{Pb}(\text{OAc})_4$ or MnO_2 and trapped either with phenyl azide **14** or with 2,5-dimethylfuran **15** to give the corresponding cycloadducts **16** and **17**.

3. Cyclohexynes

As part of the studies on pyrolytic formations of cyclohexyne and benzyne, Wentrup¹⁸ was able to prove the existence of 3-azacyclohexyne **20**. The fragmentation products of pyrrolidinylene-isoxazolone **18** in flash vacuum pyrolysis experiments (680–780 °C) were condensed on a KBr window at –196 °C. Besides the IR signals of simple compounds, a sharp peak at $\tilde{\nu}=2114\text{ cm}^{-1}$ appeared. This band was attributed to the alkyne stretching vibration of 3-azacyclohexyne **20**. As expected for an aminoacetylene, the frequency is a little higher than that of cyclohexyne **21** ($\tilde{\nu}=2090, 2105\text{ cm}^{-1}$). An insertion of the initially formed vinylidene carbene **19** in the pyrrolidine ring was proposed as mechanism for the formation of the highly strained alkyne. At temperatures above –196 °C, **20** polymerizes and the alkyne vibration disappears. The dipolar canonical structure is expected to contribute to the stabilization of this acetylene thereby accounting for the ease of its polymerization.

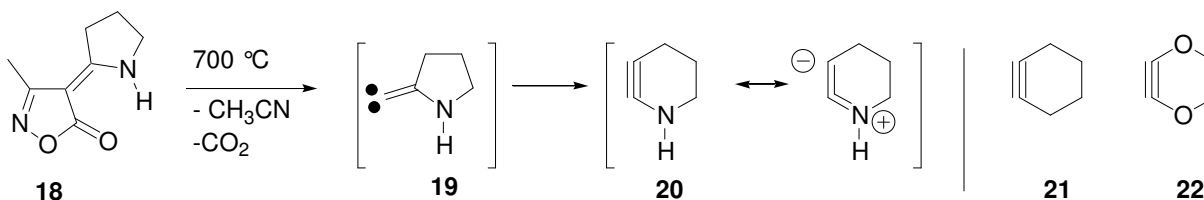

Scheme 4. Flash vacuum pyrolytic generation of azacyclohexyne **20**.

According to *ab initio* MO theory at the GVB and UHF levels, 1,4-dioxacyclohexyne **22** should have a singlet ground state with a non-planar acetylenic structure; the triple bond stretching frequency was predicted to be $\tilde{\nu}=1897\text{ cm}^{-1}$.¹⁹

In 1992, Ando²⁰ and Barton²¹ independently reported the formation and isolation of tetrasilacyclohexynes. In spite of the high geometrical ring strain in a six-membered cycloalkyne, Barton and Ando were able to prepare octamethyl tetrasilacyclohexyne **27** by a ring closure strategy with a preformed acetylene unit (Scheme 4). Dilithioacetylene **26** and 1,4-dichlorooctamethyltetrasilane **25** gave the highly strained cyclohexyne **27** in 65% yield.²⁰ Analogously, the seven-membered homologue **28** was obtained in 80% yield from **26** and 1,5-dichlorodecamethylpentasilane **29**.²⁰ Octamethyl- and octaethyltetrasilacyclohexyne **27** and **30** have also been prepared from an acetylene di-Grignard reagent **31**²⁰ (52%; 55%) whereas for the octaisopropyl-derivative **32**, dilithio acetylene **26** was used (Scheme 5).²¹

Photochemical ring contraction was reported²⁰ as a second approach to **27**. Irradiation of decamethylpentasilacycloheptyne **28** in hexane containing dimethylbutadiene with a low-pressure mercury lamp ($\lambda=254\text{ nm}$) through a quartz tube afforded the ring contracted compound **27** in 20% yield. Cyclohexyne **27** is sufficiently stable to be purified by chromatography on silica gel. Whereas the neat compound polymerizes at room temperature, storage in dilute solution at 0 °C is possible. While **27** remains unchanged in boiling toluene for a limited time,²¹ in boiling decane (175 °C) its decomposition occurred with $t_{1/2}=8\text{ h}$.²⁰

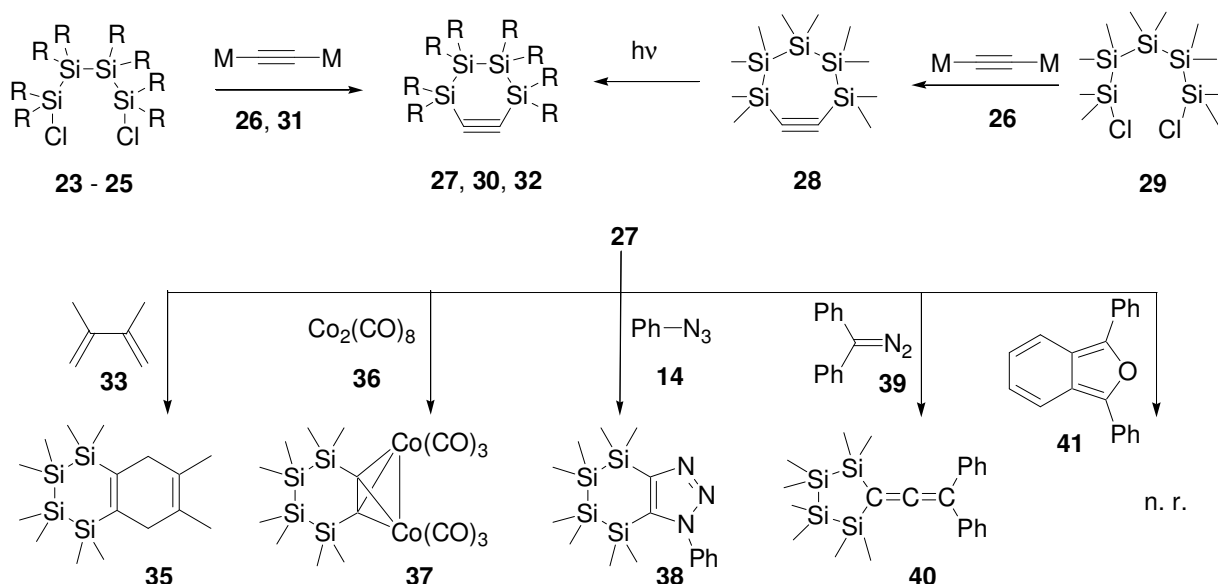

Scheme 5. Synthesis of tetrasilacyclohexynes **27** ($R=CH_3$), **30** ($R=C_2H_5$) and **32** ($R=CH(CH_3)_2$) via cyclization or photolytic ring contraction and reactions of **27**.

In a Diels-Alder competition reaction of dimethylbutadiene **33** with **27** and dimethyl acetylenedicarboxylate **34**, 50% of the silacyclohexyne **27** formed the adduct **35** while no detectable adduct of **34** was observed. With $Co_2(CO)_8$ **36** the dicobalthexacarbonyl complex **37** was formed (21%) and the reaction with phenyl azide **14** afforded the triazole **38** (the higher homologue **28** does not react with **14**). With diphenyldiazomethane **39**, a ring contracted allene **40** was formed in quantitative yield. Whereas the reaction with phenyl azide **14** indicates a highly strained compound,^{22–25} the attempted addition of diphenylisobenzofurane **41**, another typical reagent used to trap short-lived, highly strained cycloalkynes²² failed, probably due to the steric shielding of the triple bond by the adjacent dimethylsilyl groups.

Table 1. Spectroscopic and structural data of cyclic and linear silylacetylenes.

	ring size	δ ($^{13}C\equiv C$) (ppm)	δ (^{29}Si) (ppm)	$\tilde{\nu}$ (cm^{-1})	$C\equiv C-Si$ bond angle	$C\equiv C$ bond length	$(H_3C)_3Si-C\equiv C-Si(CH_3)_3$ 43
43	linear	113.0			180°		
42	8	117.8	-35.4, -38.9, -39.9				
28	7	123.2	-34.5, -38.9, -39.9				
27	6	135.7	-17.8, -30.6	2082			
30	6	136.4	-17.7, -8.3	2076			
32	6	136.7			150.5° , 146.8°	1.200 \AA	

Though **27** and its analogues **30** and **32** can be prepared by cyclization reactions, their reactivity indicates high ring strain. This is substantiated by a single crystal X-ray analysis²¹ of **32**. Tetrasilacyclohexyne possesses a highly distorted acetylene unit, the acetylenic bond angles being reduced to 150.5° and 146.8° . This geometrical deformation is reflected in the spectroscopic data of the triple bond. Table 1 collects NMR, IR and geometrical data for the cyclohexynes **27**, **30** and **32**, the higher homologues

28 and hexasilacyclooctyne **42** and the linear bis-TMS acetylene **43**.²¹ Compared to **43** ($\delta=113.0$ ppm), the ¹³C-NMR signals of the acetylene carbons suffer a strong deepfield shift with decreasing ring size. Moderate deepfield shifts to $\delta=117.8$ ppm in the eight-membered ring **42** and to 123.2 ($\Delta\delta=5.4$ ppm) in the cycloheptyne **28** are followed by a severe displacement to $\delta=135.7$ ($\Delta\delta=12.5$ ppm). This $\Delta\delta$ shift value of 23 ppm corresponds to the very strong *cis*-bending of the acetylene unit of about 30°.

4. Cycloheptynes

4.1. Oxacycloheptynes and azacycloheptynes

Following the successful route of the synthesis of tetramethylthiacycloheptyne **66** (Scheme 11) Krebs²⁶ was able to prepare 3,3,6,6-tetramethyl-1-oxacycloheptyne **45** by oxidation of bishydrazone **44** with lead tetraacetate in 94% yield (Scheme 6). Though **45** was too sensitive to be isolated, it could be trapped with phenyl azide **14** to give triazole **46**. Alkyne **45** is much more reactive than its carbocyclic **47** and its thia-analogue **66**; in diluted solution, the half-life time of **45** at -63 °C is in the range of several hours. This corresponds to an increased triple bond deformation due to reduced ring size: the C–O bonds (1.42 Å) are significantly shorter than C–C (1.54 Å) and C–S (1.81 Å) bonds. 1,3,3,6,6-Pentamethyl-1-azacyclohept-4-yne **48**, the *N*-methyl-aza analogue of **45**, has been mentioned by Krebs⁷ as a transient intermediate ($t_{1/2}=58$ min in CH₂Cl₂ at -20 °C) with a reactivity nearly as high as that of **45**.

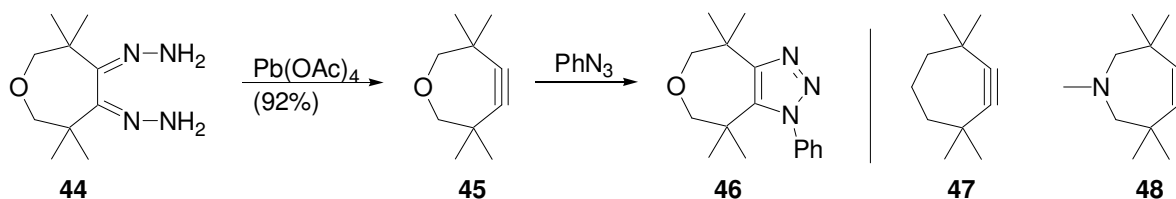

Scheme 6. Generation of oxacycloheptyne **45** and 1,3-dipolar cycloaddition with phenyl azide.

The first oxacycloheptyne **50** (Scheme 6) had been generated and trapped by Tochtermann.²⁷ Addition of bromine to dibenzooxepine followed by dehydrobromination led to the heterocyclic bromocycloheptatriene **49**. Dehydrobromination of **49** is rather difficult; it requires treatment with KO*t*-Bu in dioxane for 16 hours at 90–100 °C. The alkyne **50** was trapped *in situ* with tetracyclone **4** to give tribenzooxepine **51** (23%) (Scheme 7) and with dimethylfuran **15** to give the corresponding Diels-Alder adduct (43%). Platinum-complexes of **50** had been obtained by dehydrobromination of **49** in the presence of Pt(PPh₃)₃.²⁸ Alkyne **52**, the aza-analogue of **50**, was generated by a similar dehydrobromination with KO*t*-Bu as a base and it was trapped *in situ* as Diels-Alder adducts of furan²⁹ and of *N*-methylpyrrole and also by polar addition of imidazole.³⁰

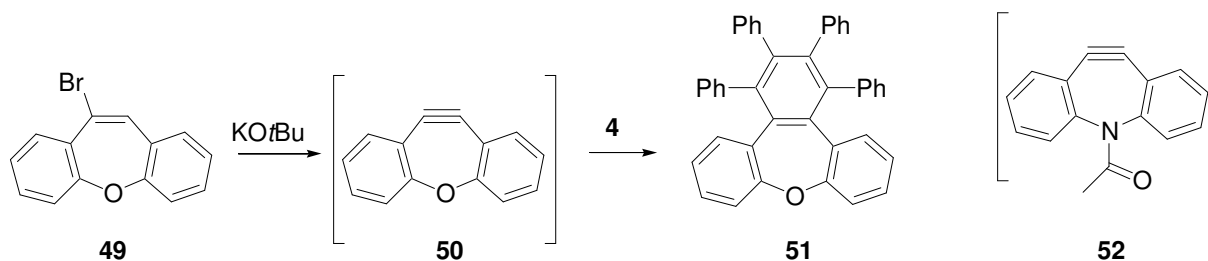

Scheme 7. Preparation of dibenzooxacycloheptyne **50** and trapping with tetracyclone.

Besides these two free oxacycloheptynes, a few dicobalthexacarbonyl complexes of oxepynes are known. Complexation of a ω -carboxy propargylic alcohol **53** with $\text{Co}_2(\text{CO})_8$ and Mukaiyama lactonization afforded the first seven-membered acetylenic lactone as its cobaltcarbonyl complex **54** (Scheme 8).³¹

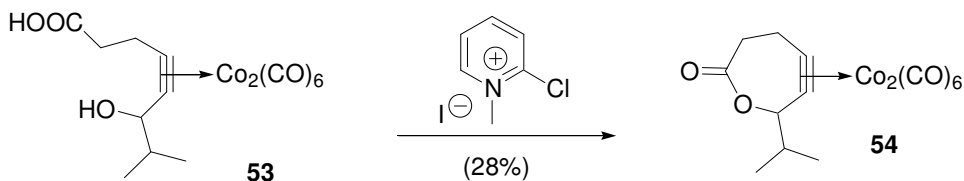

Scheme 8. Lactonization of the cobalt-complexed acetylenic ω -hydroxyacid **53**.

Bending of the triple bond by complexation followed by cyclization has also been used by Brook³² for the synthesis of mono- and spirocyclic dioxasilacycloheptynes. The reaction between the dicobalthexacarbonyl complex of 2-butyne-1,4-diol **55** and dichlorosilanes resulted in the formation of 1,3-dioxa-2-silacycloheptynes as their cobaltcarbonyl complexes **59–62** (Scheme 9).

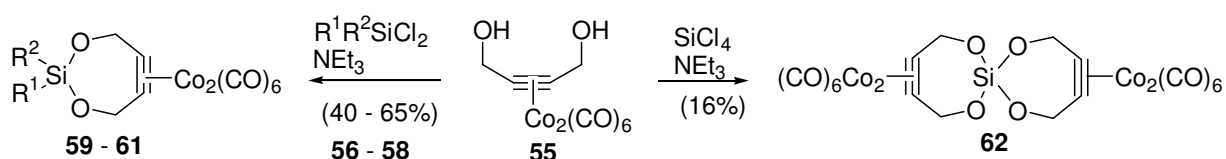

59: $\text{R}^1=\text{R}^2=\text{Ph}$: 65%; **60:** $\text{R}^1=\text{Ph}$, $\text{R}^2=\text{CH}_3$: 52%; **61:** $\text{R}^1=\text{R}^2=\text{CH}_3$: 40%.

Scheme 9. Cobalt-complexes of dioxasilacycloheptynes.

Dicobalthexacarbonyl complexes of annulated oxacyclohept-3-yne, oxacyclonon-5-en-3-yne and oxacyclonona-3,5-diyne have been prepared by Isobe³³ as intermediates in the synthesis of marine natural products, *e.g.*, gambietoxin 4B.³⁴ A reductive decomplexation with tributyltin hydride gave the corresponding alkenes. 2-Benzyloxyethyl substituted oxacyclohept-3-yne was obtained as its $\text{Co}_2(\text{CO})_6$ complex **64** from **63** *via* hydrogen transfer and intramolecular Nicholas reaction. Reduction of **64** with Bu_3SnH and H_2/Pd furnished the saturated heterocycles (Scheme 10).³⁵

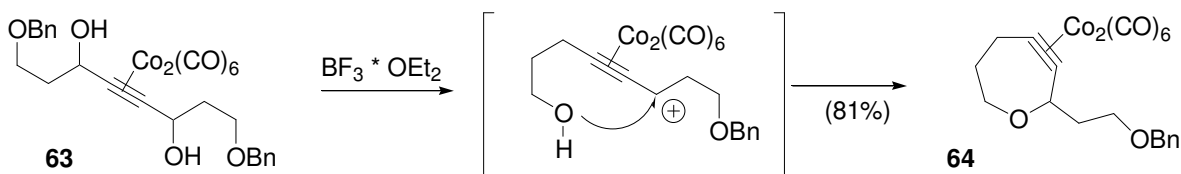

Scheme 10. Formation of Co-complexed oxacycloheptyne **64** *via* Nicholas cyclization.

4.2. Thiacycloheptynes

Probably the most important cycloheptyne, 3,3,6,6-tetramethyl-1-thiacyclohept-4-yne **66** (Scheme 11), has been reported by Krebs in 1970.³⁶ With the combination of longer C–S bonds reducing the ring strain and a tetramethyl substitution shielding the distorted triple bond, this compound was the first stable cycloheptyne and a shining milestone for further research on strained compounds. Oxidation of 1,2-bis-hydrazone **65** with Ag_2O (Scheme 11) and purification by preparative gas chromatography gave the desired **66** in 5.5% yield. Using lead tetraacetate as an oxidant was a major improvement of this method since the reaction time could be reduced, the yield of the alkyne increased to 60–67% and the alkyne was purified *via* distillation.³⁷

This cycloheptyne is stable at $-80\text{ }^{\circ}\text{C}$ in an inert atmosphere, but it adds oxygen at room temperature to form the 1,2-diketone **67** (via the 1,2-dioxetene), it adds water in the presence of HgSO_4 to form the ketone **66** and it is oxidized by mCPBA to a new alkyne **69** containing a sulfoxide group. A Diels-Alder reactions occurs with diphenylisobenzofurane **41** (51%), but not with tetracyclone **4**. The alkyne spontaneously adds 1,3-dipoles such as hydrazoic acid (32% of **70**), phenyl azide (91% of **71**) and nitrones over several hours to give **72** and **73** ($> 80\%$). With carbon disulfide, an orange-red tetrathiafulvalene **74** was formed in 55% yield within 30 minutes; the same reaction with cyclooctyne **75** requires several weeks. A [2+2] cycloaddition of dichloroketene results in a high yield (80%) of the dichlorocyclobutenone **76**. Similarly, **66** adds tosyl isocyanate to give β -lactam **77**.⁷ According to theoretical studies on cycloadditions of **66** and **69** to ethylene, these highly strained cycloalkynes should react more like a monocarbene than like an alkyne or vicinal dicarbene.³⁸ Singlet oxygen in freon as solvent attacks the triple bond,³⁹ the rate constants for the deactivation of $^1\text{O}_2$ with **66**, **92** (the *S,S*-dioxide of **66**, Scheme 15), **75** and **69** drop by a factor of 50 in this sequence.⁴⁰

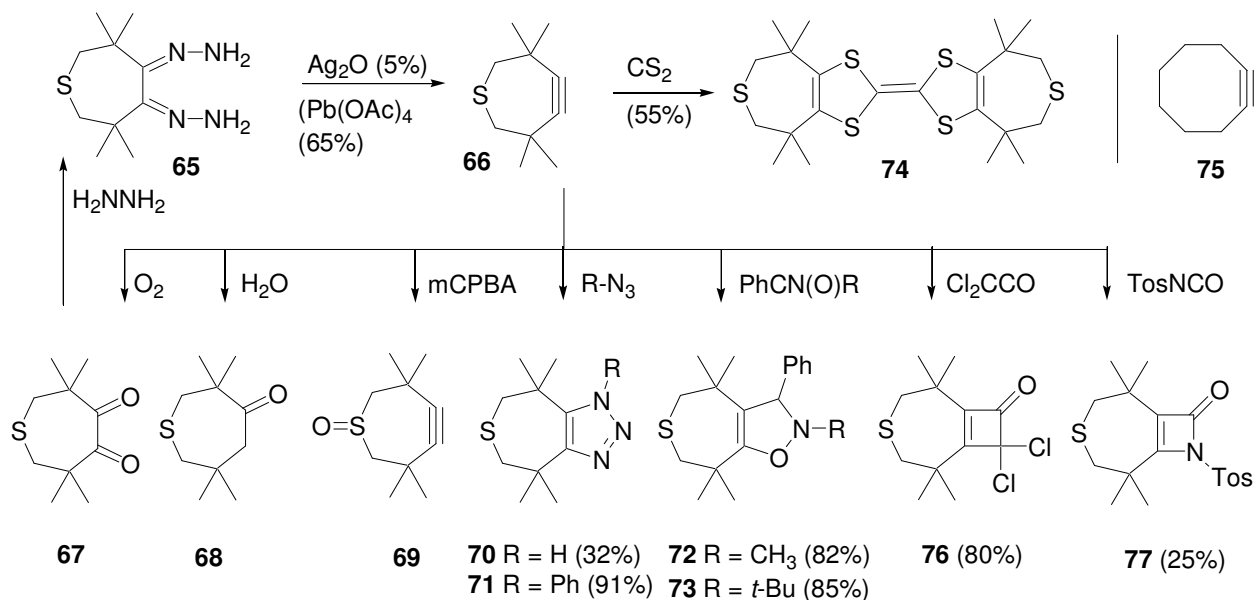

Scheme 11. Synthesis and some reactions of tetramethylthiacycloheptyne **66**.

Isocyanides add to electron rich and to highly strained cyclic alkynes. The [1+2] cycloaddition of *p*-nitrophenyl isocyanide to **66** results in the formation of 80% of the corresponding cyclopropenone imine **77** within 3 hours at $25\text{ }^{\circ}\text{C}$ (Scheme 11).⁴¹ Cyclooctyne **75** does not react under analogous conditions.

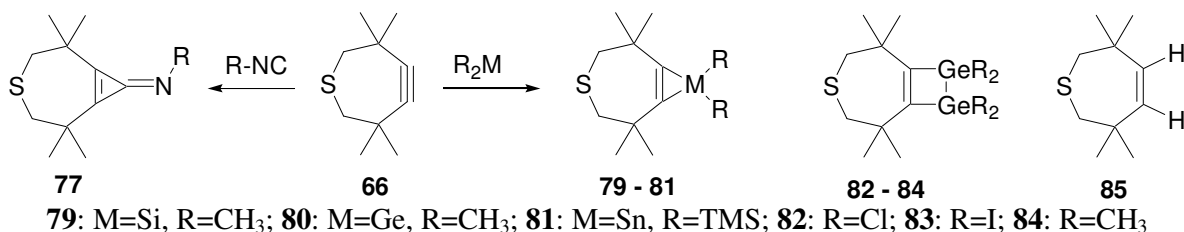

Scheme 12. Formation of cyclopropenone imine, metallacyclopropenes and metallacyclobutenes.

Compound **66** adds silylenes⁴²⁻⁴⁵ and germylenes^{43,44} to yield metallacyclopropenes **79** and **80** (Scheme 12). With the addition of a stannylenes to **66**, the first stannacyclopropene **81** was formed and

analyzed by X-ray diffraction.⁵⁰ In solution at $-16\text{ }^{\circ}\text{C}$, **81** is in a thermal equilibrium with **66** and the stannylene. Dichlorogermane, diiodogermane and tetramethyl-digermylene add to **66** to form the corresponding annulated 1,2-digerma-cyclobutenes **82–84**.^{46–49} 1,2-Dihydroarenes transfer hydrogens to **66** to form tetra-methylthiacycloheptene **85**. This aromatization takes place by a pericyclic process.⁵¹ Similarly, 2-propanol reduces the alkyne to **85**.⁵² These reactions prove the higher reactivity of **66** relative to cyclooctyne and also the strong shielding effect of the tetramethyl substitution (contrary to **66**, **75** adds **4** spontaneously!).

Table 2. Spectroscopic and structural data of **66** and related alkynes.

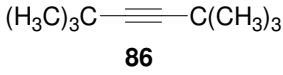
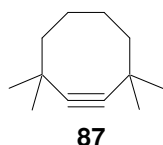
	ring size	δ ($^{13}\text{C}\equiv\text{C}$) (ppm)	IR: $\tilde{\nu}$ ($\text{C}\equiv\text{C}$) (cm^{-1})	$(\text{H}_3\text{C})_3\text{C}-\text{C}\equiv\text{C}-\text{C}(\text{CH}_3)_3$
86	linear	87.0	2276, 2221	
87	8	98.1	2230	
66	7	108.5	2200, 2170 (Raman: 2172, 2145)	
69	7	104.6	2180	
90	7	101.7	2177	

Krebs also studied the strong impact of incorporating a triple bond into a seven-membered ring with spectroscopic methods.^{36,37} Since $^1\text{H-NMR}$ spectra of **66** (60 MHz, $27\text{ }^{\circ}\text{C}$) showed two singlets, one for the methylene, one for the methyl groups, either a highly symmetrical conformation or a significant conformational flexibility has to be assumed in this strained ring. Cooling to $-100\text{ }^{\circ}\text{C}$ resulted in the expected signal splitting and coalescence appeared at $T_c = -90\text{ }^{\circ}\text{C}$ (60 MHz). The deformation of the triple bond reduces the acetylene vibration frequencies (Table 2) and the corresponding bands of the linear di-*t*-butyl-acetylene **86** appear at significantly higher energies. *cis*-Bending of the acetylene shifts $^{13}\text{C-NMR}$ signals of the alkyne to deeper field. Whereas **86** gives a signal for the *sp* carbons at $\delta=87.0$ ppm, ring strain in tetramethylcyclo-octyne **87** shifts this signal to $\delta=97.6$ ppm. However, the resonance of the alkyne in **66** is even further shifted to $\delta=108.5$ ppm. Photoelectron spectra⁵³ of **66** showed that the HOMO energy does not change very much upon *cis*-bending of the alkyne, but a splitting of the otherwise degenerate π -orbitals was observed. The increase in the MO energy in the π_y MO is believed to be the source of the enhanced reactivity of strained cycloalkynes. The molecular structure of **66** has been determined by means of electron diffraction data.⁵⁴ Methyl groups and hydrogens adopt staggered positions in the nonplanar, C_s -symmetrical conformation. Whereas most bond lengths and angles are close to typical values, the bond angles at the triple bond are reduced to 145.8° . This deformation of 34.2° from the 180° geometry is considerably higher than in cyclooctyne **73** (bond angle: 158.5°).⁵⁵

Contrary to di-*t*-butylacetylene **86** that reacts with PdCl_2 to give an alkyne-Pd complex, the reactions of **66** with PdCl_2 or $(\text{C}_6\text{H}_5\text{CN})_2\text{PdCl}_2$ afford the yellow palladium-cyclobutadiene complex **88** (93%, 80%) (Scheme 13).^{56,57}

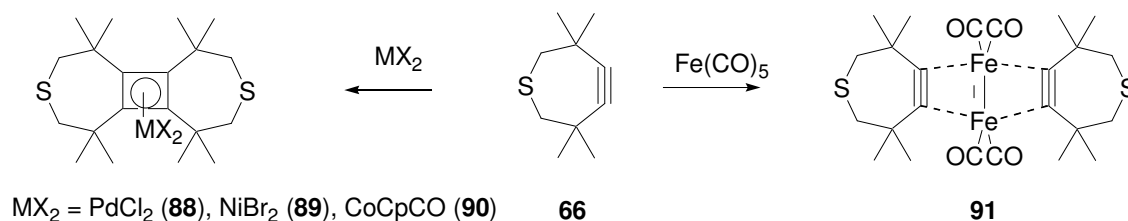

Scheme 13. Reactions of **66** with metal salts and carbonyl complexes.

This is possible since the strong deformation of the triple bond in the cycloheptyne reduces the steric hindrance of the four tertiary butyl groups around the cyclobutadiene. Similarly, treatment of **66** with NiBr₂ delivers the cyclobutadiene-nickel complex **89** (81%) whereas iron pentacarbonyl gives a dimeric alkyne-iron dicarbonyl complex **91**. At low temperatures, cyclopentadienylcobalt dicarbonyl gives a 1:1 complex, but an excess of **66** leads to cyclopentadienones accompanied by the cyclobutadiene complex **90** (11%).⁷ Removal of the metal by reaction of **88** with DPPE gave the free bis-annulated cyclobutadiene.⁵⁶ Thiacycloheptyne **66** appeared to be a good ligand for transition metals, especially copper complexes have been intensively prepared and characterized by Weiss and by Behrens.⁵⁸⁻⁷¹ Furthermore, **66** can substitute cyclooctyne **75** in the dimeric **75**-CuBr complex to give a complex with two different cycloalkyne ligands.⁷² Complexation of silver ions is a typical reaction of strained π -systems;⁷³ occasionally, this reversible reaction has been used for isolation of strained cycloalkynes from complex mixtures.⁷⁴ Thiaalkyne **66** forms complexes with silver cyanide, triflate, acetate, tetrafluoroborate or hexafluoroacetylacetonate, X-ray structures and spectroscopic data were reported.⁷⁵ Relatively small coordination shifts of $\Delta\tilde{\nu}=82-115\text{ cm}^{-1}$ indicate weaker bonding of silver ions to the alkynes compared to copper(I)–alkyne interactions ($\Delta\tilde{\nu}=174-184\text{ cm}^{-1}$). Whereas the acetylene ¹³C-NMR resonances are nearly unbiased by Cu(I) complexation, Ag(I) complexation shifts these signals about 3–5 ppm to higher field. Complexes of the type [(**64**)AuCl] are easily formed.⁷⁶ The crystals are built from chains with the Au bonded to the acetylene and to the sulfur of the next ring. The strong η^2 -coordination of the triple bond was confirmed by IR spectroscopy: the C≡C stretching vibration shifted from $\tilde{\nu}=2188, 2161\text{ cm}^{-1}$ to $\tilde{\nu}=1930, 1910\text{ cm}^{-1}$. This shift is much larger than those found in related CuCl complexes.

The *S*-oxide **69** and the *S,S*-dioxide **92** derived from **66** have also been studied (Scheme 14). Tetramethylthiacycloheptyne-*S*-oxide **69** has been obtained by oxidation of **66** with mCPBA in 67% yield (Scheme 11).³⁷ In a second approach to **69**, bishydrazone **65** was first oxidized to its *S*-oxide **93** followed by lead tetraacetate oxidation to give **69**.⁷⁷ Spectroscopic data (Table 2) reflect the ring strain, the ¹³C-NMR resonances of the acetylenic carbons appear at $\delta=104.6\text{ ppm}$ and the alkyne vibration frequency is shifted to $\tilde{\nu}=2180\text{ cm}^{-1}$.⁷ The preparation of tetramethylthiacycloheptyne-*S,S*-dioxide **92** follows the successful route for **66** with an additional oxidation of **67** to the *S,S*-dioxide **65**, formation of bishydrazone **94** and oxidation of **94** to alkyne **92**.

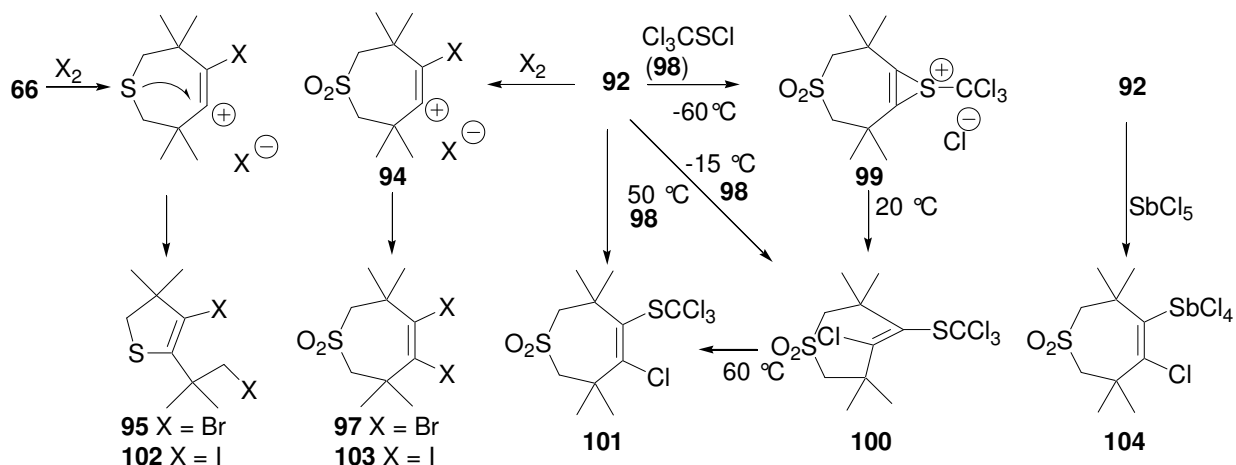

Scheme 14. Synthesis of thiacycloheptyne-*S*-oxides **69** and **92**.

Spectroscopic data^{78,79} of **92** (Table 2) are in accordance with a highly strained alkyne. Compared to **66** ($\delta=108.5$ ppm), the ^{13}C -NMR signals of the triple bonds in **69** and **92** appear at higher field. This cannot be explained by reduced ring strain, probably anisotropic effects of the S=O units account for these significant upfield shifts relative to **66**. *cis*-Bending of the triple bond in **92** has been confirmed by X-ray diffraction. The asymmetric unit contains two molecules with different ring strain; the acetylenic bond angles of one molecule are 151.8° and 151.7° , those of the more strained conformer are 146.0° and 148.0° .⁸⁰

Whereas the electrophilic addition of bromine to **66** results in the formation of a ring-contracted dibromide **95** *via* transannular attack of the sulfur atom,^{7,79} addition of bromine to **92** gives the *cis*-dibromocycloheptene **97**.⁷⁹ Under optimized reaction conditions, a non-symmetrical cationic intermediate **96** was isolated and characterized.^{78,81} *cis*-Heteracycloheptene **101** is the final product of the addition of trichloromethyl sulfonyl chloride **98** to **92**, but it was possible to generate and characterize the thiirenium ion **99** and *trans*-heteracycloheptene **100** as intermediates.⁷⁸ Addition of iodine to **66** and **92** results in the analogous diiodo-compounds **102** and **103**^{78,79} and SbCl_5 adds to **92** to give an antimony substituted cycloheptene **104** (Scheme 15).

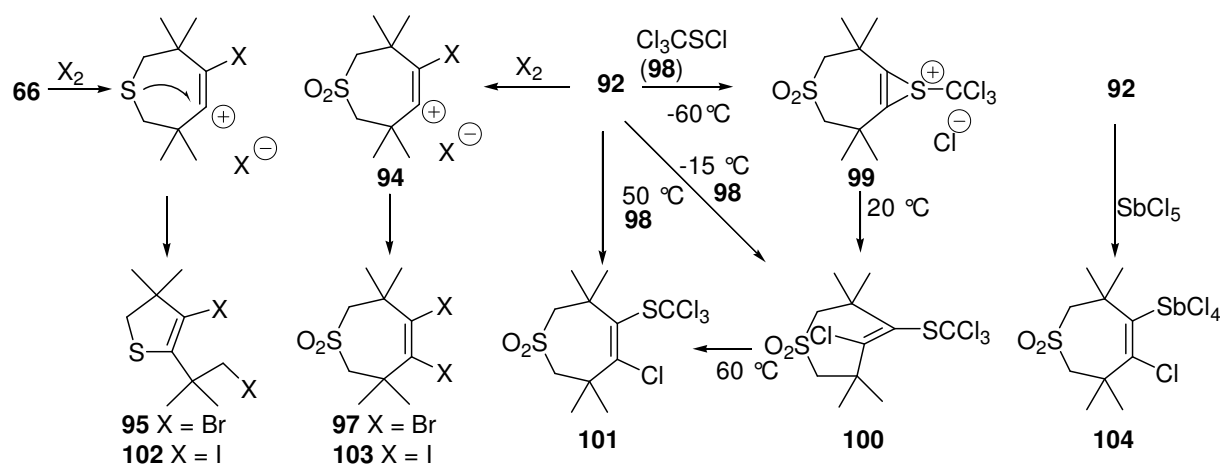

Dienes like anthracene or 6,6-diphenyl fulvene add **92** to give the normal Diels-Alder cycloadducts.⁸² A few Cu(I)-complexes of **92** have been prepared⁷⁸ and **92** forms complexes with silver salts, several complexes have been studied by X-ray diffraction.⁷⁵ Relatively small coordination shifts of $\Delta\tilde{\nu}=82\text{--}115\text{ cm}^{-1}$ indicate weaker bonding of **92** to silver ions compared to **92**-copper(I) interactions ($\Delta\tilde{\nu}=174\text{--}184\text{ cm}^{-1}$); upon Ag(I) complexation, the ^{13}C -NMR resonances are shifted about 3–5 ppm to higher field. Similarly, **92** forms a complex of the type $[(\mathbf{92})\text{AuCl}]$, in the crystal as a dimeric complex with bridging chlorine atoms. Due to complexation, the $\text{C}\equiv\text{C}$ stretching vibration shifted from $\tilde{\nu}=2177\text{ cm}^{-1}$ to $\tilde{\nu}=1949, 1928\text{ cm}^{-1}$.⁷⁶ A dibenzo-annulated derivative of **92** has been prepared *via* bromination/dehydrobromination of dibenzothiepin-*S,S*-dioxide *via* **105** to **106** (Scheme 16).²⁷ The dehydrobromination of **105** to the alkyne **106** with KOH in methanol (7 hours, 65°C) afforded the enol ether **107**. Dehydrobromination with $\text{KO}t\text{-Bu}$ was much faster (30 minutes, 25°C); in the presence of furan the Diels-Alder adduct **109** was isolated, the enamine **108** was formed if piperidine was present and the triazole **110** was formed by 1,3-dipolar cycloaddition of phenyl azide **14**.

It took 14 years until the corresponding thiadibenzocycloheptyne **113** was described.⁸³ A thermal fragmentation of 1,2,3-selenadiazole **111** led to this formally antiaromatic thiacycloheptyne **113** that could

be trapped as adduct **114** of tetracyclone (14%) or as **116** (26%) with rhodacyclopentadiene **115**.⁸⁴ Nevertheless, the main product was bis-annulated diselenine **117**, resulting from dimerization of the primary formed diradical **112** (Scheme 17). The reluctance to form the highly strained cycloheptyne is responsible for the high yield of **117**. Nevertheless, in the analogous preparation of the carbocyclic alkyne **119** (CH₂ instead of S) the trapping products were isolated only in 3% and 14% yield which correlates with the higher strain energy in the latter ring. Fragmentation of the selenadiazole **111** with butyl lithium gave only selenoether **118** as product. In this system, the activation barrier for the elimination of selenium is much higher than in the case of the cyclooctyne series and only selenium-containing products are formed.

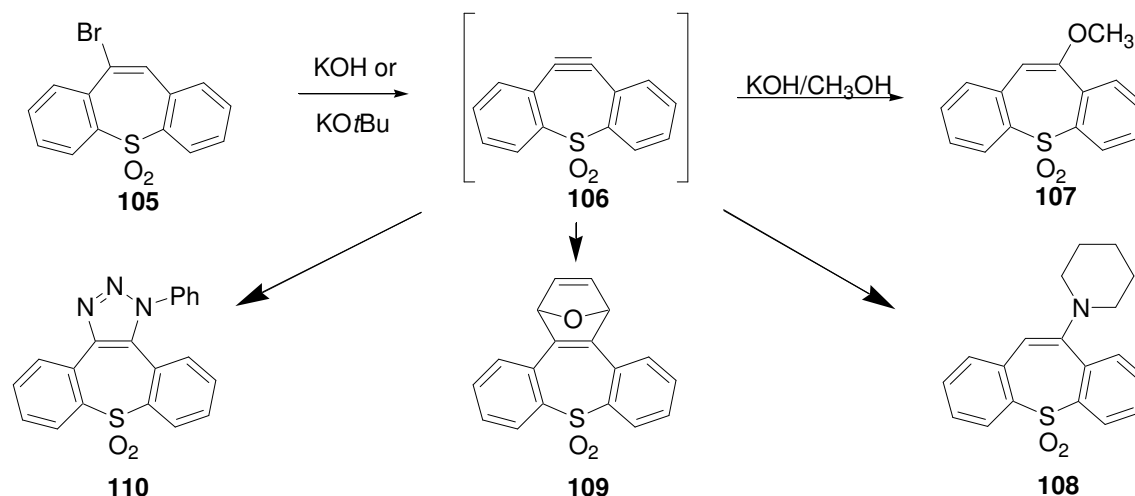

Scheme 16. Synthesis and reactions of dibenzothiacycloheptyne-*S,S*-dioxide **106**.

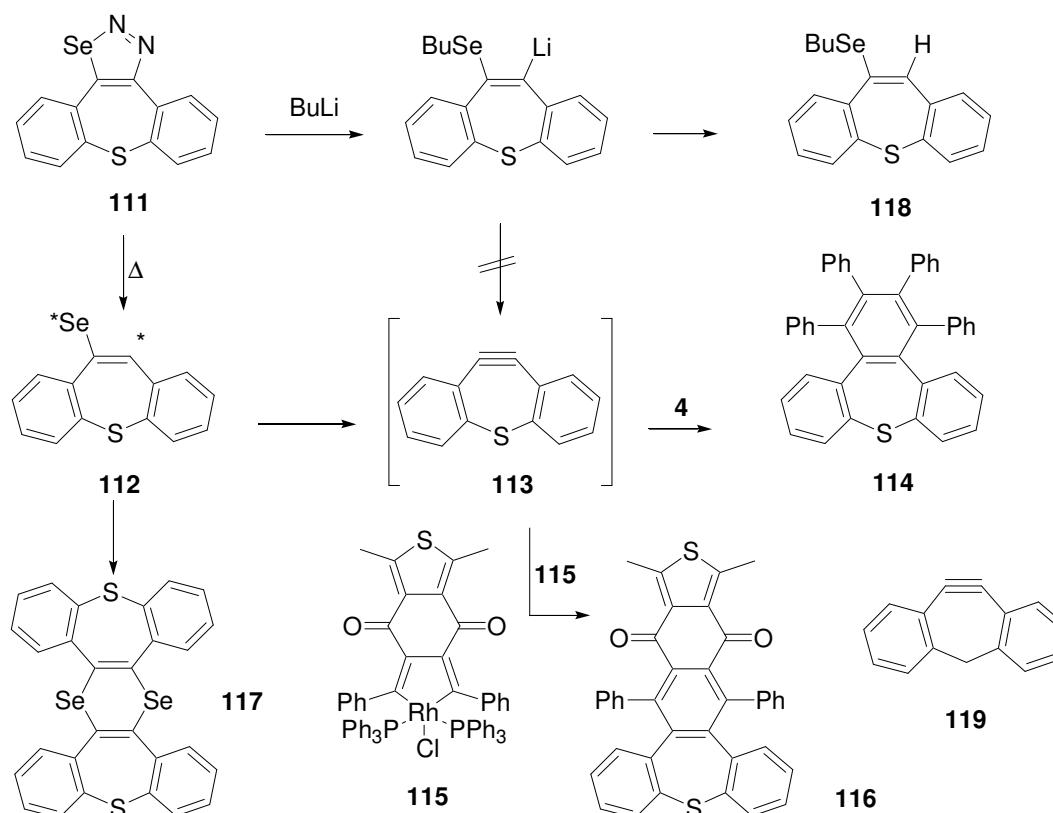

Scheme 17. Dibenzothiacycloheptyne **113**: synthesis and trapping reactions.

Rees *et al.* noted the ease of the nucleophilic substitution on 6-bromo-1,3,5-trithia-2,4-diazepine **120** with aliphatic amines like diisopropylethylamine giving aminotrithiadiazepines **122** in 70–86% yield (Scheme 18).⁸⁵ They established the hetaryne **121** as an intermediate in these substitutions.⁸⁶ **121** was trapped as Diels-Alder adducts by several 1,3-dienes like dimethylfuran **15** (75%) or as adduct **123** of diphenylisobenzofurane **41** (92%). In a competition reaction between **41** as a reactive diene and morpholine as a strong nucleophile, the morpholino derivative **122** (75%) was isolated almost exclusively with only 3% of **123**. Rees concluded that the formation of the aryne **121** occurs *via* intermediacy of a relatively stable carbanion with extensive delocalization of the negative charge onto the heteroatoms of the 10 π -aromatic ring. Aryne **119** adds diphenyldiazomethane to give the corresponding pyrazole.⁸⁷

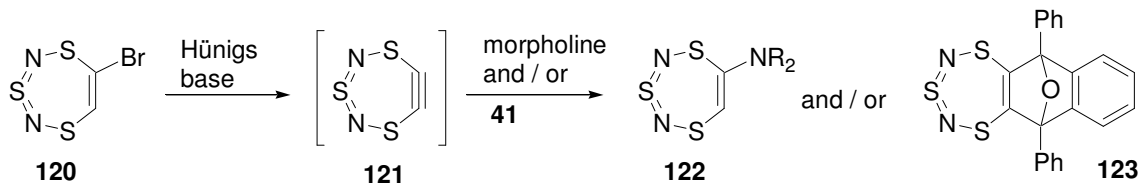

Scheme 18. Trithiadiazepyne **121**.

Ab initio calculations⁸⁸ on a series of cyclic iminoboranes and iminoalanes with ring sizes of 4 to 7 showed that they adopt angularly distorted structures compared to cycloalkynes. Despite being isoelectronic, cyclic iminoboranes and iminoalanes do not provide good models for cycloalkynes. The combination of different atomic sizes and electronegativities of the heteroatoms allows these systems to adopt structures and electronic configurations unavailable to the cycloalkynes.

4.3. Silacycloheptynes

Similar to the exchange of methylene groups in strained cycloalkynes by sulfur, the replacement of CH₂ by a dialkylsilylene group results in a reduced ring strain due to longer heteroatom-carbon bonds. Two main subjects have been investigated: cycloheptynes with one silicon atom in the ring and with systematic variation of the steric shielding and polysilacycloheptynes.

The oxidative degradation of 1,2-bishydrazones was the method of choice for the generation of the triple bond in silacycloheptynes **124–128** (Scheme 19).

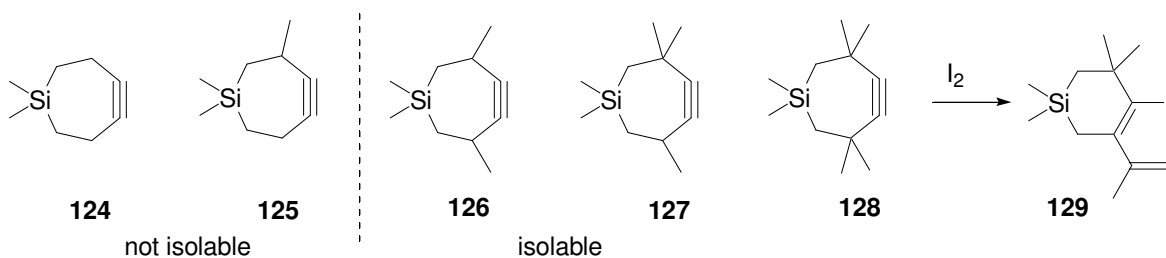

Scheme 19. Silacycloheptynes with increasing shielding of the triple bond and addition of I₂ to **128**.

1,1-Dimethylsilacyclohept-4-yne **124** was obtained in 66% yield. The alkyne is moderately stable in diluted solutions with a half-life time of 108 hours at 4 °C. Attempts to isolate this strained but not shielded cycloheptyne **124** failed.⁸⁹ Shielding of the triple bond with one methyl group as in **125** is not sufficient to allow an isolation. The alkyne, obtained in 25% yield (as adduct with tetracyclone **4**) has a lifetime of *ca.* 49

hours (in CH₂Cl₂ at 0 °C). One, two or three more methyl groups in the propargylic positions are sufficient to allow the isolation of **126–128**. Only minor effects of methyl substitution on the spectroscopic properties of the triple bond were noted. Alkyne vibrations of **126–128** were recorded at $\tilde{\nu}$ =2190 cm⁻¹ and the signals of the *sp* carbons appeared at δ =100.7 ppm (**126**, **128**) and δ =103.2, 98.2 ppm (**127**).^{7,89}

One attempt to quantify strain energy is based on the heat of hydrogenation of the alkyne to the corresponding *cis*-alkene. With a heat of hydrogenation of $\Delta H_{\text{H}}=-131.7$ kJ/mol, linear di-*t*-butylacetylene **86** was used as a reference compound. Ring strain enhances ΔH_{H} , e.g. $\Delta H_{\text{H}}=-171.1$ kJ/mol for 3,3,8,8-tetramethylcyclooctyne **87** ($\Delta\Delta H_{\text{H}}=-39.4$ kJ/mol). With $\Delta H=-187.8$ kJ/mol ($\Delta\Delta H_{\text{H}}=-56.1$ kJ/mol), **128** is substantially more strained but not as much as its thia analogue **66** ($\Delta H=-218$ kJ/mol, $\Delta\Delta H_{\text{H}}=-86.3$ kJ/mol).^{7,89} In Diels-Alder reactions of **127** and **128** with α -pyrone and anthracene, the normal [4+2] cycloadducts were obtained but the rates of the reactions of **127** were about three times higher than those of **128**. Diphenylisobenzofurane **41**, a typical reagent for strained alkynes, does not react with **127** and **128**, probably due to steric congestion of the α -methyl groups and the phenyl rings. Whereas the electrophilic additions of trichloromethyl sulfonyl chloride **98** and Br₂ to **128** gave mixtures of at least 7 compounds, reaction with iodine results in the formation of the ring-contracted product **129** (71%; comp.: **66** to **95**, Scheme 15). Like **66**, penta- and hexamethylsilacycloheptynes **127** and **128** react with anhydrous NiBr₂ to cyclobutadiene-nickel complexes of the type **89** (Scheme 13) but the reactions are significantly slower. The analogous reaction with PdCl₂ is possible with **127** (to the sila-analogue of **88**), but the steric shielding of the triple bond in **128** prevents the molecule from dimerization and a simple alkyne-Pd complex was obtained.⁸² **128** forms dimeric complexes with CuCl.⁹⁰ The vibrational frequency shifts from $\tilde{\nu}$ =2181 cm⁻¹ to $\tilde{\nu}$ =2006 cm⁻¹. This coordination shift of $\Delta\tilde{\nu}$ =175 cm⁻¹ is a little smaller than the shifts found with **66** ($\Delta\tilde{\nu}$ =180 cm⁻¹) and the isocyclic derivative **47** ($\Delta\tilde{\nu}$ =177 cm⁻¹, 184 cm⁻¹). The smaller shift results from a weaker bonding of the silacycloheptyne to the metal compared to the interaction of CuCl with the more strained **66** and **47**. This series of compounds clearly shows the reduced ring strain of sila-cycloalkynes compared to their thia-analogues **66**. The longer Si–C bonds reduce the ring strain and simultaneously increase the steric shielding of the triple bond. Both reduce the reactivity of the alkyne, which is further modulated by the number of adjacent methyl groups.

4.4. Polysilacycloheptynes

Deprotonation of propargyl magnesium bromide and cyclization with 1,4-dichlorooctamethyl-tetrasilane **23** led to a tetrasilacycloheptyne **130** in 81% yield.⁹¹ Due to ring strain, the ¹³C-NMR signals of the *sp* carbons are shifted to δ =117.5, 88.3 ppm and the vibration frequency of the triple bond to $\tilde{\nu}$ =2126 cm⁻¹. A twofold deprotonation of the propargylic position of **130** with butyl lithium gave dilithio cyclohepta-1,2-diene **131**. With **23**, a second cyclization occurred, thus generating betweenallene **132** with two tetrasilylene tethers (Scheme 20).

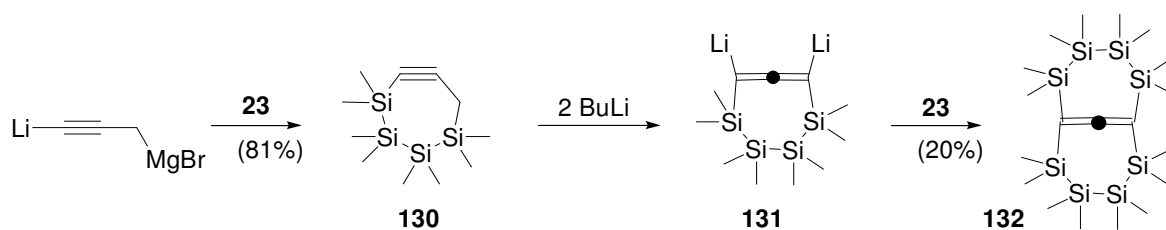

Scheme 20. Synthesis of tetrasilacycloheptyne **130** and transformation to betweenallene **132**.

Pentasilacycloheptyne **28** had been intensively investigated by Ando.^{20,92,93} The photolysis (low-pressure mercury lamp) of dodecamethylhexasilacyclooctyne **42** gave the ring contracted **28** in 22% yield (Scheme 21). Forced thermal conditions (550 °C) also initiated the extrusion of a dimethylsilylene unit from **42** and **28** was formed in 18% yield. Contrary to the more strained analogous cyclohexyne **27**, steric shielding in decamethylpentasilacycloheptyne **28** inhibits the addition of phenyl azide, a reagent that had been used to differentiate strained from strain-free compounds.²³ Like the photochemical formation of **28** from **42**, irradiation of **28** with UV light ($\lambda=254$ nm) causes ring contraction to cyclohexyne **27** (Scheme 21).

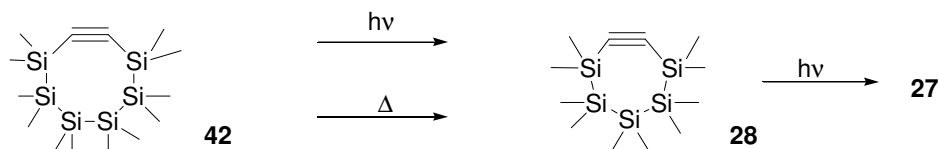

Scheme 21. Successive ring contractions in the silacycloalkyne series.

X-Ray diffraction carried out on single crystals of **28** established the molecular structure.⁹² The Si–Si bond lengths are in the range between 2.340–2.353 Å, the Si–C bonds are 1.80–1.84 Å and the triple bond is 1.22 Å long. The most interesting point in the structure of **28** is the bending of the triple bond: the observed bond angles are 159.6° and 162.2°, values which are far from the ideal 180° geometry but similar to the moderately strained cyclononyne.⁹⁴ Accordingly, ¹³C-NMR reveals ring strain in **28** by a deepfield shift of the *sp* carbon signals of **28** ($\delta=123$ ppm) relative to the higher congener **42** ($\delta=117.8$ ppm). Pentasilacycloheptyne **28** replaces carbon monoxide in (Cp)₂Mo₂(CO)₆; the resulting complex Me₁₀Si₅C₂*Mo₂(CO)₄(Cp)₂ was obtained in 60% yield and its structure has been determined by X-ray diffraction.⁹⁶

Irradiation of the tetraphenyl-octamethyl hexasilacyclooctyne **133** in cyclohexane gave two ring-contracted cycloheptynes **134** and **135** (14% and 16%), but the same experiment in an acetone/hexane mixture gave both alkynes as minor compounds, together with two pairs of isomeric acetone adducts **137**, **138** and **139**, **140** (yields: <11%) (Scheme 22). Two photochemical ring contraction pathways operate:⁹⁵ the direct extrusion of dimethylsilylene from **133** to give **134** and the rearrangement of **133** to a silacyclopropene **139**. The latter compound can eliminate diphenylsilylene to give the other cycloheptyne **135** or it can add acetone to form the bicyclic ethers **140** and **141** (Scheme 22).

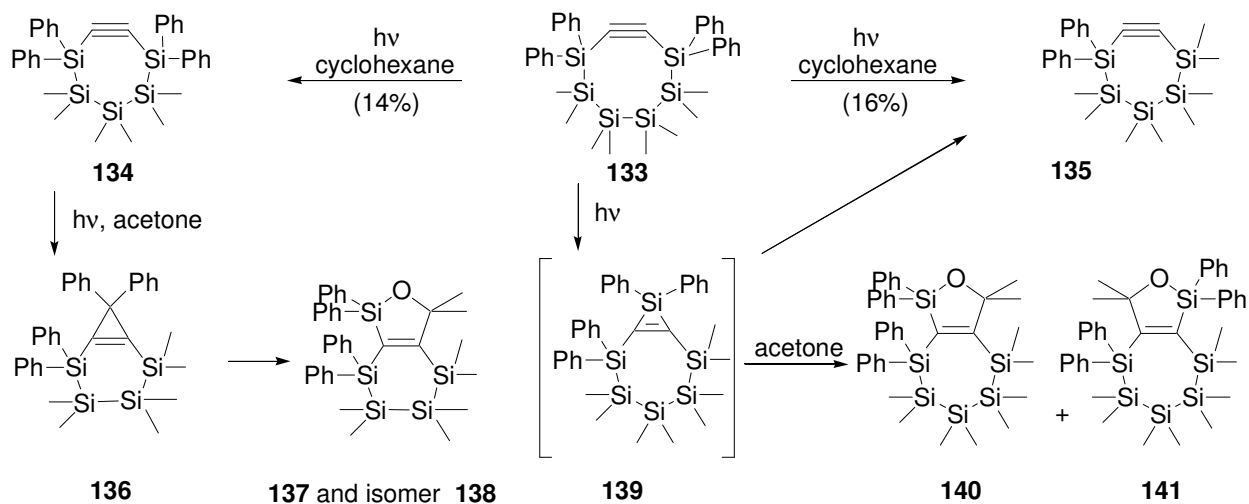

Scheme 22. Photochemical ring contraction of **133**.

Starting from **142**, the 3,3,4,4,-tetraethyl analogue of **133**, Ando could prove that the 2-silylene as well as the 3-silylene groups can be eliminated in the direct ring contraction (ratio: *ca.* 1/1).

Hexamethyl-3,6,7-trisilacycloheptadiyne **145** was isolated as a by-product (3% yield) in the pyrolysis of decamethylpentasilacyclonona-4,8-diyne **143**.⁹⁷ Under these conditions (680 °C, 10⁻² mmHg), also octamethyl-1,2,5,6-tetrasilacyclooctadiyne **144** suffered ring contraction to the seven-membered diyne (6.3% yield). The alkyne **145** is sensitive to air but thermally sufficiently stable to be purified by sublimation. Spectroscopic data are collected in Table 3, indicating a major increase in ring strain upon ring contraction to **145** (Scheme 23).

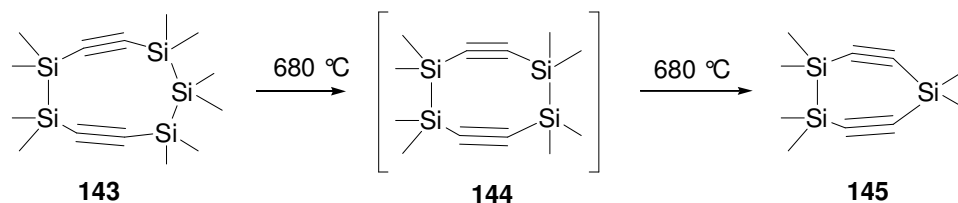

Scheme 23. Flash-vacuum pyrolysis of **143** and **144** to give ring-contracted diyne **145**.

Table 3. Spectroscopic data of cyclic and linear silylacetylenes. **42**=dodecamethylhexasilacyclooctyne, **43**=bis-trimethylsilyl acetylene.

	δ (¹³ C) (ppm)	δ (²⁹ Si) (ppm)	$\tilde{\nu}$ (Raman) (cm ⁻¹)
43	113.0		
42	117.8	-35.4, -38.9, -39.9	
143	115.7, 116.4	-45.6, -35.8, -34.2	2091
144	119.5	-33.6	2082
145	126.7, 132.3	-26.9, 1.6	2042

5. Cyclooctynes

5.1. Oxacyclooctynes

The oxidation of the semicarbazone of oxacyclooctane-3-one **146** with selenic acid gives the regioisomeric selenadiazoles **147** and **148** in moderate yield (53%) and regioselectivity (3/7). 1-Oxa-3-cyclooctyne **151** was formed in 59% yield by thermolysis of selenadiazole **148** on copper.⁹⁸ The high ring strain shifts the IR vibration of the triple bond to $\tilde{\nu}=2235$ cm⁻¹ and the ¹³C-NMR signals of the *sp* carbons appear at $\delta=104.9$ ppm (C3), 93.4 ppm (C4). Refluxing a xylene solution of selenadiazole **148** and tetracyclone **4** gives the Diels-Alder adduct **152** in 67% yield (Scheme 24).

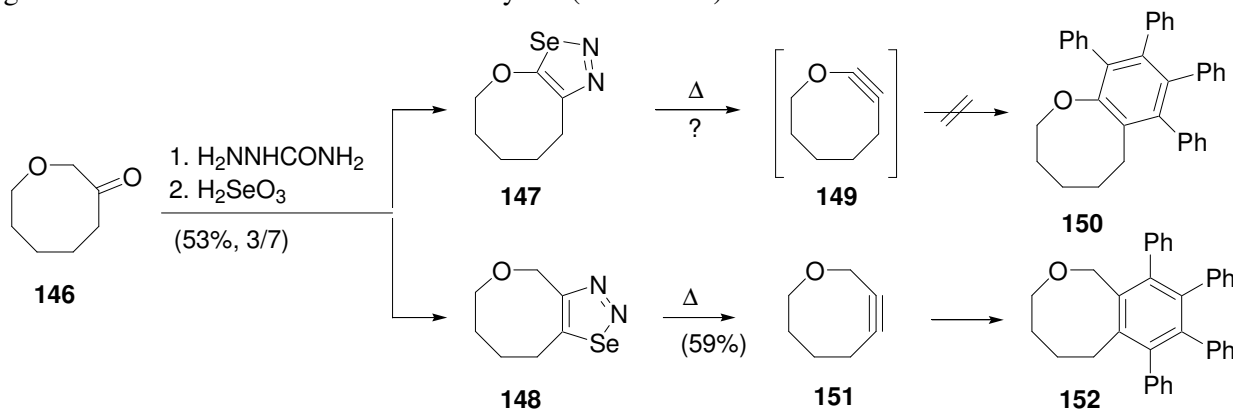

Scheme 24. Attempted and successful syntheses of oxacyclooctynes.

Unfortunately, no trapping product **150** of 1-oxa-2-cyclooctyne **149** was detected in the same experiment with the isomeric selenadiazole **147**. MNDO calculations result in $\Delta H_f=57.6$ kJ/mol for the cyclic propargyl ether **151** but $\Delta H_f=95.6$ kJ/mol for the cyclic ynol ether **149**. Though no theoretical relation between thermodynamic and kinetic stability exists, they appear to be correlated. The polarization of the triple bond in **149** additionally contributes to its poor stability (Scheme 24).

Cho⁹⁹ reported intramolecular Diels-Alder reactions of α -pyrones with acyloxy- or acrylamido substituted alkynyl groups **153–160**; the tethers were en passant converted to medium-sized lactones **161–164** and lactams **165–168**. At a first glance, yields of 31% **161** and 10% **165** are synthetically not attractive, but these are perhaps the first direct formations of a cyclooctyne *via* cyclization without complexation of the triple bond or heavier atoms (S, Si) in the ring. Transesterification of the tricyclic lactames **165–168** with sodium methoxide or their reduction with LiAlH₄ gave bicyclic lactames **169–171** and amines **172–174** in excellent yields (Scheme 25, Table 4). If the tether carries a methyl group on the terminal position, the cyclization to medium-sized rings can be highly diastereoselective.¹⁰⁰

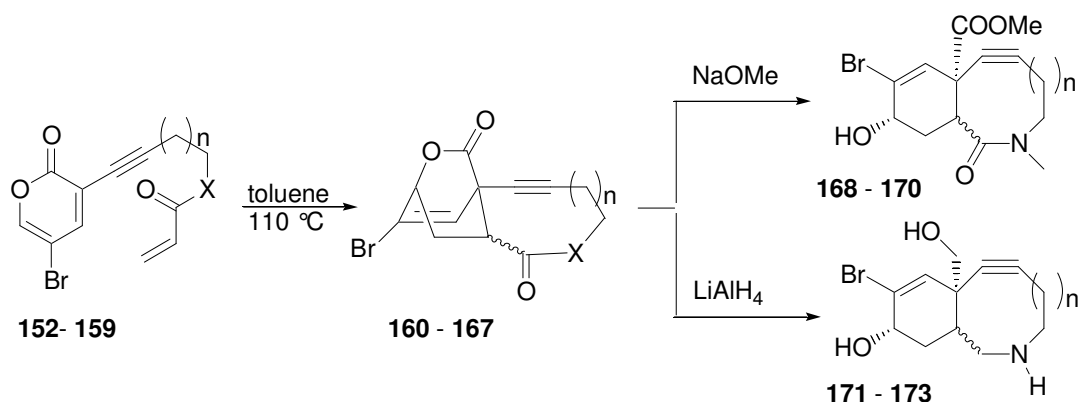

n	X	tricyclic compd.	Yield	endo/exo	lactams	yield	amine	yield
1	O	161	31%	60/40				
2	O	162	51%	100/0				
3	O	163	55%	100/0				
4	O	164	66%	100/0				
1	NH	165	10%	n.a.	169	97%	172	93%
2	NH	166	46%	47/53				
3	NH	167	53%	100/0	170	91%	173	90%
4	NH	168	69%	100/0	171	96%	174	93%

Scheme 25 and Table 4. Synthesis of acetylenic lactones and lactams *via* intramolecular Diels-Alder cyclization.

5.2. Azacyclooctynes

Thermal fragmentation of selenadiazole **175** and *in situ* trapping with tetracyclone **4** proved the intermediary existence of 1-*p*-tolylazacyclooct-4-yne **176** (Scheme 26).¹⁰¹ The free azacycloalkyne **176** was isolated in 50% yield by treatment of **175** with butyl lithium at -78 °C, together with a butyl selenoether resulting from incomplete fragmentation (*cf.* Scheme 17).¹⁰² With ¹³C-NMR signals at $\delta=98.2$ and 94.8 ppm for the *sp*-carbon atoms, this alkyne seems to be much more strained than the isocyclic analogue (cyclooctyne: $\delta=90.9$ ppm). In fact, it adds **4** immediately and quantitatively to form the benzoannulated azocine **176**.

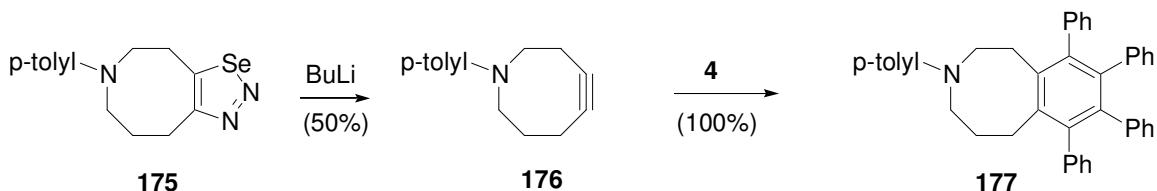

Scheme 26. Synthesis and trapping of azacyclooct-4-ene **176**.

Currently, bioorthogonal chemical reactions are of extraordinarily high interest for the exploration of numerous biological processes. A widely used bioorthogonal functional group is the azide which can be incorporated into biological molecules by feeding cells azide-functionalized substrates. Location and dynamics of the azide-labeled biomolecules can be monitored by chemical ligation with probes bearing complementary functionalities. The copper-catalyzed click-reaction is ideal for many applications but Cu(I) is cytotoxic even at low concentrations. A copper-free approach, the “strain-accelerated addition of azides” relieves that burden. The high reactivity of strained compounds with azides had been discovered by Alder and Stein^{23,24} in 1931 and used as a criterion for strain in cycloalkynes by Wittig and Krebs.²² Especially cyclooctynes are preferred dipolarophiles.^{103–106} Recently, aza-cyclooctynes came in the focus due to their increased ring strain, higher polarity and the possibility to attach functional handles.

Bertozzi *et al.*¹⁰⁷ reported the synthesis of azacyclooctyne **181** with additional hydrophilic groups (Scheme 27). Dimethoxyazocanone **179** with an *N*-succinyl side chain was used as starting material for the synthesis of selenadiazole **180** (60%). Thermal fragmentation (47%) of **180** followed by saponification with LiOH (60%) gave azacyclooctyne **181**. Probe molecules like biotin were attached to the lateral carboxylic acid. Compared to the fluorocyclooctynes, these compounds are much more polar and can be used in aqueous systems without the need for an organic cosolvent.

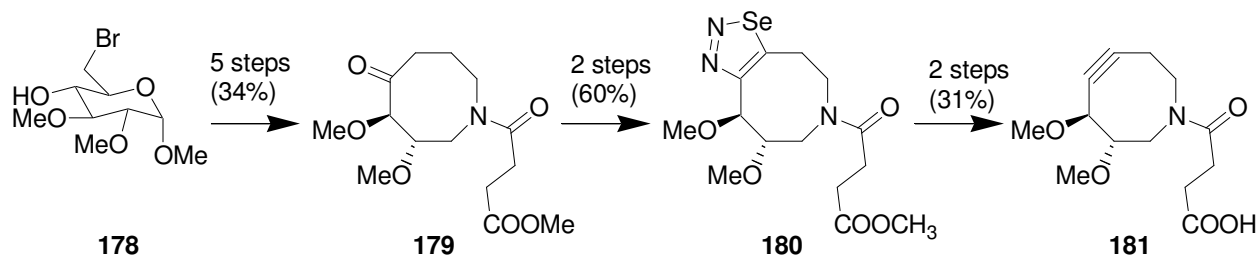

Scheme 27. Synthesis of a carboxy-functionalized azacyclooctyne.

Dibenzoazacyclooctynone **186** has been prepared *via* Fischer indole synthesis from indanone and phenyl hydrazine followed by *N*-allylation **182**, silylation of the dihydroazapentalene fragment **183** (93%), and oxidative cleavage of its central double bond **184** (Scheme 28).¹⁰⁸ Treatment of the potassium enolate of the keto-amide with trifluoromethanesulfonic anhydride gave the corresponding α -silyl enol triflate (55%). After manipulation of the side chain of this latter intermediate to allow for subsequent conjugation to a probe molecule **185**, reaction with cesium fluoride introduced the strained triple bond in excellent yield (85%). The reactivity of this azacyclooctynone **186** towards benzyl azide is about 450 times higher than that of an unactivated cyclooctyne. BARAC **186** has been attached to a variety of probes like biotin and fluorescein and was proved to be very useful for fluorescence imaging.

Starke *et al.*¹⁰⁹ reported a short and flexible route to similar dibenzoazacyclooctynes. A twofold Friedel-Crafts reaction of a donor-substituted benzyl-aniline **187** with tetrachlorocyclopropene followed by

hydrolysis gave the annulated cyclopropenone **188** (Scheme 29). This was converted into dibenzoazacyclooctyne **189** by UV-irradiation. The ^{13}C -NMR signals of the alkyne function ($\delta=105.0, 108.0$ ppm) are strong indicators for the high ring strain –and therefore for a high reactivity in strain-promoted azide-alkyne cycloadditions. A succinic amide handle allows the attachment of biological and fluorescent probes.

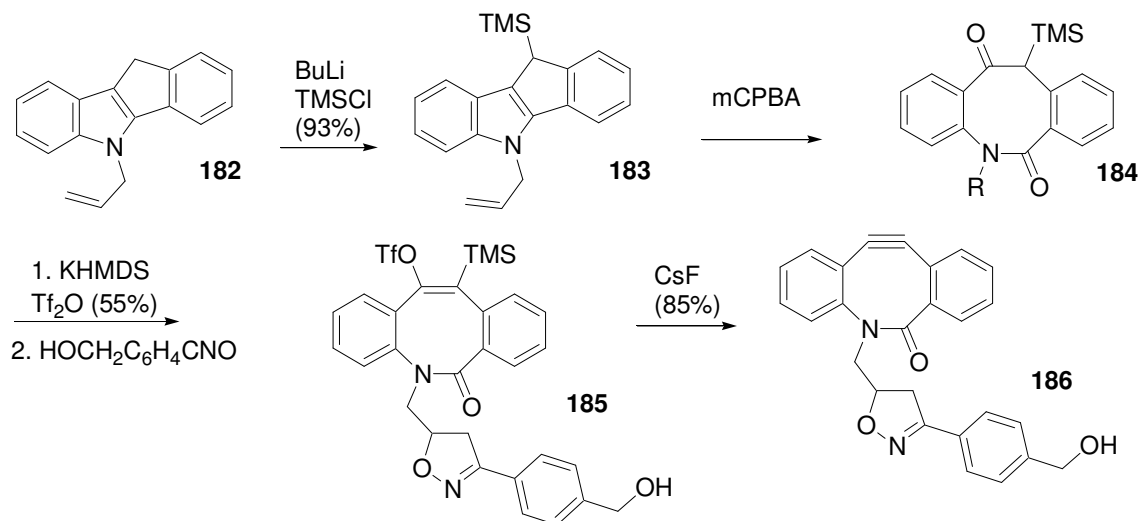

Scheme 28. Synthesis of an acetylenic eight-ring lactame BARAC.

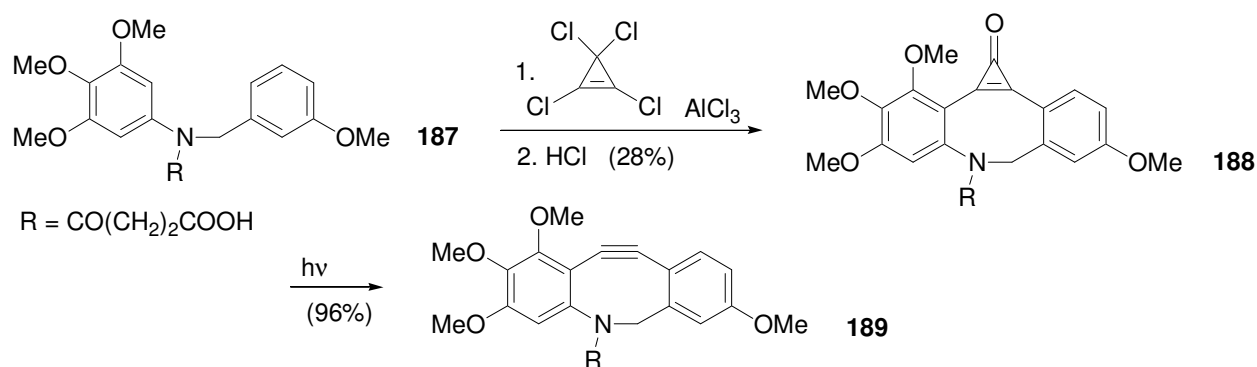

Scheme 29. Photochemical decarbonylation to azacyclooctyne **189**.

Dibenzoazacyclooctene **191** has been prepared by intramolecular reductive amination of *cis*-2-formyl-2'-aminostilbene **190** (Scheme 30).¹¹⁰ Cbz-protection of the amine, followed by addition of bromine (67%) and elimination with *KOt*-Bu (87%), yielded the *N*-protected aza-dibenzocyclooctyne **196** (R=Cbz). Attempts to generate the free amino group failed due to transannular attack of the nitrogen on the alkyne resulting in the formation of isoindoloindole. For applications of this alkyne as dipolarophile in azide-alkyne cycloadditions tagging biomolecules, a suitable handle was attached to the nitrogen instead of the Cbz protecting group **193** (R=CO-(CH₂)₃COOCH₃) and after bromination/dehydrobromination the strained cycloalkyne **197** with a functional handle was obtained in 41% yield over nine steps. After saponification of the ester with LiOH (**198**: R=CO(CH₂)₃COOH, 92%) and PEGylation of the handle, DIBAC has been used for fast and quantitative ligations.

Beckmann rearrangement on the dibenzosuberone oxime followed by reduction of **199** (Scheme 31) yielded dibenzoazacyclooctatriene. After attachment of a functional side chain to the nitrogen atom (**200**), the alkene was dehydrogenated by bromination/dehydrobromination to **201**. Removal of the trifluoroacetate

with K_2CO_3 in methanol gave the final alkyne **202** ($R=CO-(CH_2)_5-NH_2$). ^{13}C -NMR data of the *sp* carbons ($\delta=114.8, 107.9$ ppm) give evidence for a high reactivity of ADIBO.¹¹¹ This reactive dipolarophile was attached to surfaces for the immobilization of azide-tagged substrates. Alternatively, conjugation of the azacyclo-octyne to a variety of molecules allows their anchoring to azide-derivatized surfaces.

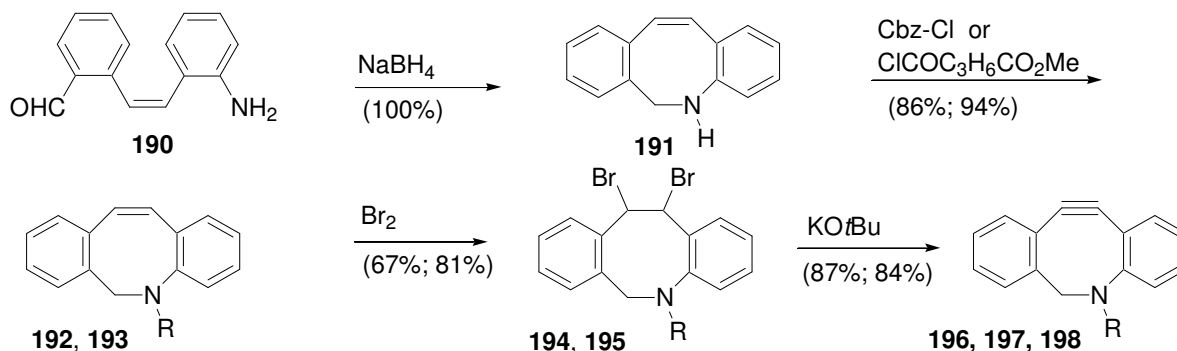

Scheme 30. Synthesis of DIBAC **198** ($R=CO(CH_2)_3COOH$).

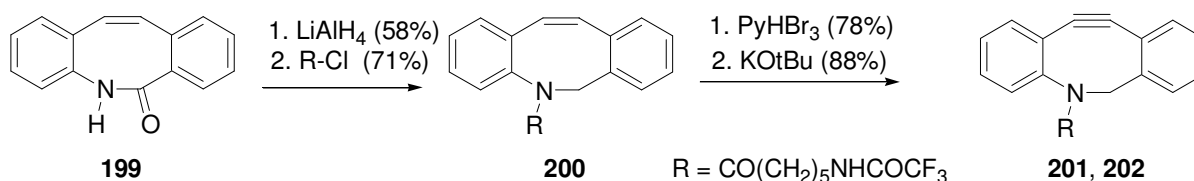

Scheme 31. Synthesis of ADIBO **202** ($R=CO(CH_2)_5NH_2$).

With the preparations and first applications of **181**, **186**, **189**, **198** and **202**, the lively chemistry of strained heterocycloalkynes made a momentous shift from physical organic chemistry towards life science. Bioconjugation *via* alkyne-azide additions^{112–114} has become an important tool in biology and experimental medicine. Application of these efficient azacyclooctyne anchors is only at its beginning, *e.g.* Wu *et al.* used biotin-functionalized BARAC **186** for tracking *N*-acetyllactosamine on cell-surface glycans *in vivo*¹¹⁵ and van Hest¹¹⁶ applied DIBAC **198** for the construction of comb-shaped peptide-polymer bioconjugates. Fluorescence imaging,^{117–119} targeted drug delivery,¹²⁰ biocompatible copolymer formation for cell encapsulation^{121,122} and [^{18}F]-labeling of azido-functionalized peptides and carbohydrates for positron emission tomography (PET)^{123–125} are currently hot topics for the use of azacyclooctynes. Important results on the application of these systems have been collected recently^{126–128} and a large number of differently substituted azacyclooctynes has been patented.¹²⁹

5.3. Thiacyclooctynes

1-Thia-2-cyclooctyne **206** had been prepared from 1-thia-3-cyclooctanone **203** *via* oxidation of the semicarbazone with selenic acid and thermolysis of the 1,2,3-selenadiazole **204** (Scheme 32).^{130,131} The relatively stable thiacyclooctyne **206** was obtained in 35% yield. In addition to the geometrical ring strain, a polarization of the triple bond occurs. Contrary to the high electron density on the β -carbon atom of ynol ethers, in **206** the negative charge is located on the sulfur atom and the acetylenic β -carbon is electron deficient. IR confirms ring strain ($\tilde{\nu}=2200$ cm^{-1}) and ^{13}C -NMR data polarization of the triple bond by a large difference ($\Delta\delta=25.3$ ppm) of the *sp* carbon resonances, the signal of C3 appearing at 105.5 ppm and C2 at 80.2 ppm. In alkaline solution, 1-thiacyclooctyne adds water to the thioether-ketone **203**, but the

regioselectivity is inverted in acidic solution. BF_3 -catalyzed addition of ethanol and ring opening furnished ethyl 7-mecapto-heptanoate **207** in 40% yield. Tetracyclone **4** adds quantitatively to **206**, the 1,3-dipolar cycloaddition of diazomethane leads to a 31/69 mixture of pyrazoles **208** and **209** and the addition of carbon disulfide gives tetrathiafulvalenes (26%, 1/1 mixture of isomers **211** and **212**).

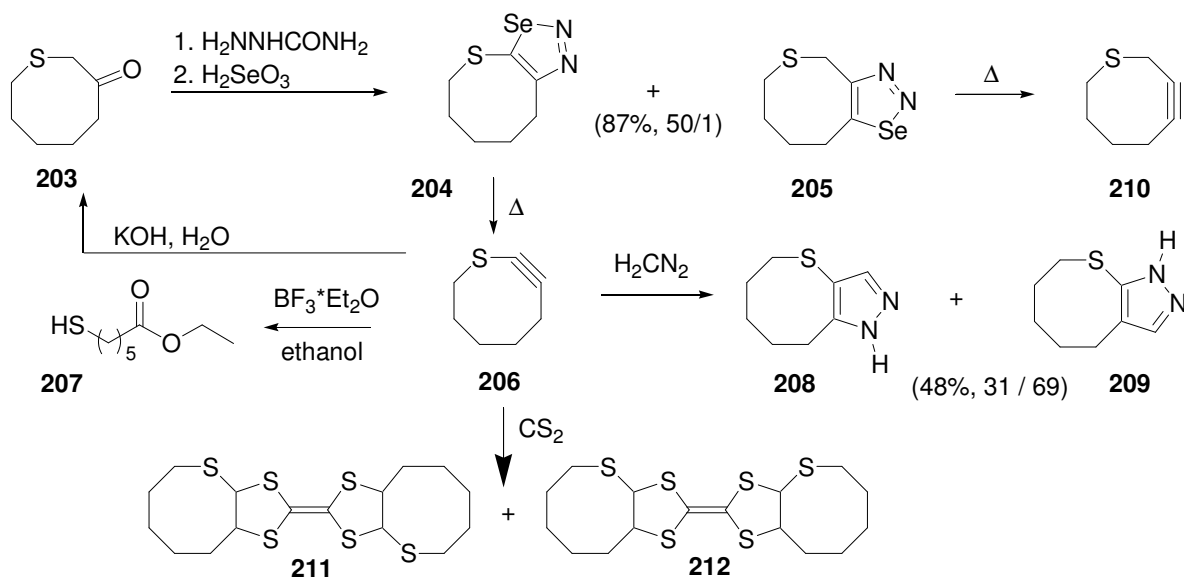

Scheme 32. Synthesis and reactions of mono-thiacyclooctynes **206** and **210**.

As a by-product in the synthesis of selenadiazole **204**, the isomer **205** was isolated in 1.7% yield. Thermolysis of **205** gave 1-thia-3-cyclooctyne **210** in low yields. A comparison of the ^{13}C -NMR data of a polarized alkynylthioether, strained cyclooctyne **75** and the thiacyclooctynes distinctly shows the high ring strain of thiacyclooctynes ($185 < \Sigma\delta < 188$) and the polarized acetylene ($\Delta\delta = 25.3$ ppm).

Table 5. Strain and polarization in thiacyclooctynes.

	δ ($\equiv\text{CC}$) (ppm)	δ ($\equiv\text{CS}$) (ppm)	$\Sigma\delta$	$\Delta\delta$
1-Methylthio-1-butyne	91.5	66.1	157.6	25.4
206	105.5	80.2	185.7	25.3
210	97.2/88.0	-	185.2	9.2
73	94.4/94.4	-	188.8	0

The possible structural isomers of dithiacyclooctyne **213–221** (Figure 1) have been studied by the MNDO method.¹³² Predicted deformations of the bond angles at the *sp* carbon atoms are in the range of 162° – 165° and the torsion angles at the triple bond vary between 0° and 14° . Isomers **218–221** with the sulfur atoms in the β - or γ -positions are energetically favoured, higher energies result from one (**213–216**) or even both sulfur atoms (**217**) in α -positions with respect to the triple bond.

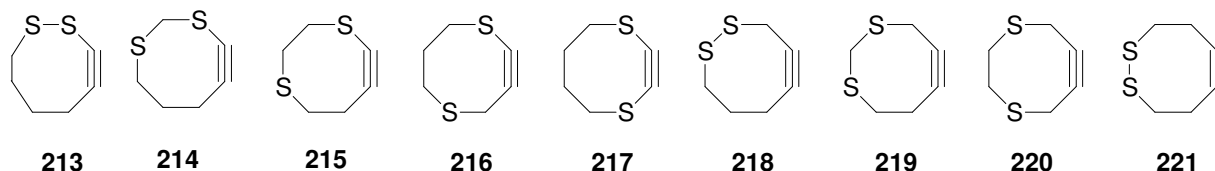
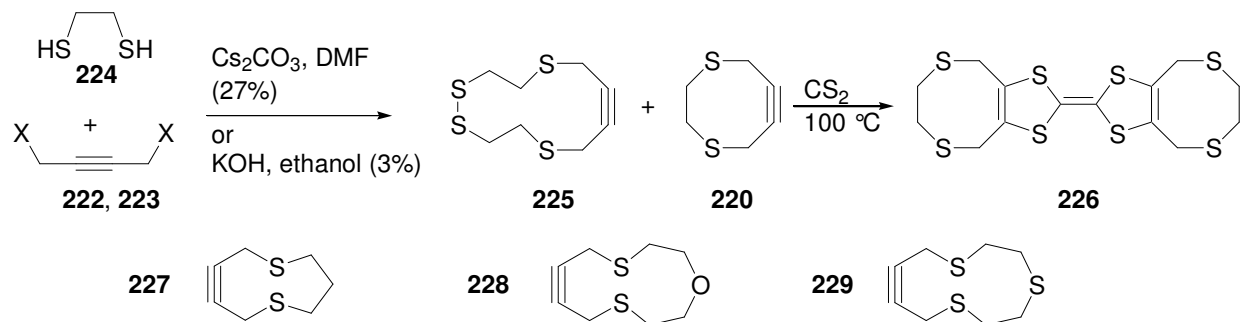

Figure 1. Nine possible structural isomers of dithiacyclooctyne.

Furthermore, the α -thia substitution (compound **206**) of the strained acetylene causes a polarization of the triple bond with a higher negative charge on the carbon atom directly bound to sulfur.

1,4-Dithiacyclooct-6-yne **220** had been prepared by Meier¹³³ *via* cesium-assisted cyclization of ethanedithiol **224** and 1,4-dibromobut-2-yne **222** in 27% yield, together with 1,4,5,8-tetrathiacyclododec-10-yne **225** with a disulfide unit (Scheme 33). Compound **225** was formed by the reaction of two equivalents of **224** with one equivalent of **222** followed by autoxidation (7%). The cesium effect was also applied in the synthesis of 1,6-dithiacyclonon-3-yne **227** (33%) and 1,7-dithia-4-oxacycloundec-9-yne **228** (33%). This template proved to be necessary for the formation of the strained ring during cyclization. In this case, the otherwise successful reagent KOH in ethanol to form thiacycloalkynes from dithiols and **223** failed.¹³⁴



Scheme 33. Synthesis of 1,6-dithiacyclooctyne **220** (**222**: X=Br, **223**: X=Cl) and higher homologues.

The strained nature of dithiacyclooctyne **220** was confirmed by a single crystal X-ray diffraction study.¹³⁴ The bond length of the triple bond, 1.191 Å, is comparable to the bond length found in the homologous but not strained¹³⁵ 1,4,7-trithiacycloundec-9-yne **229** but the bond angles in **220** are reduced to 164°. The C_2 -symmetrical conformation is similar to that adopted when **220** is coordinated *via* the alkyne to a $Co_2(CO)_6$ unit.¹³⁶ MM+ force field calculations predict angles at the *sp* carbon atoms of 161.5°. Spectroscopic data reflect the ring strain in **220**: the stretching vibration of the triple bond is shifted to $\tilde{\nu}=2220\text{ cm}^{-1}$, significantly lower than for unstrained alkynes;¹³⁷ the ^{13}C -NMR resonances of the *sp* carbons appear at deeper field, $\delta=90.9\text{ ppm}$. The difference with the δ value found for the isocyclic cyclooctyne **75** ($\delta=94.4\text{ ppm}$) might be due to the electronic influence of the heteroatoms and longer C–S bond lengths, resulting in smaller ring strain. Accordingly, the reactivity of the dithiacycloalkynes is somewhat reduced in comparison to the carbocyclic alkynes. 1,4-Dithiacyclooct-6-yne **220** adds tetracyclone **4** (62%) and reacts –under forcing conditions– with carbon disulfide to form a bis-annulated tetrathiafulvalene **226** (26%).¹³³

1,5-Dithiacyclooct-2-yne **216**, the second known member of the dithiacyclooctyne family has been prepared by the selenadiazole fragmentation method (Scheme 34). The generation of **216** by thermal fragmentation of selenadiazole **230** in the presence of tetracyclone **4** gave a poor yield (24%) of the cycloadduct **231**; thermolysis of **230** on copper afforded 5% of **216**.

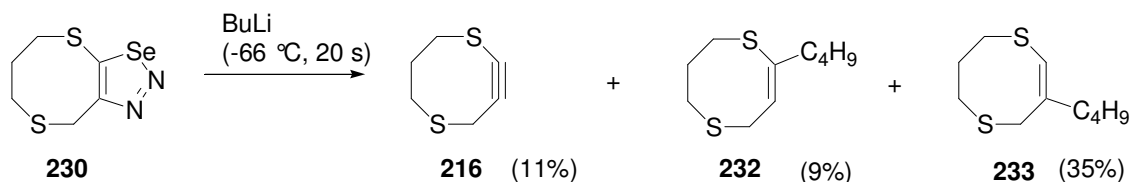

Scheme 34. BuLi fragmentation of selenadiazole **230** to alkyne **216**.

A better yield of the alkyne (11%) was obtained by fragmentation of **230** with butyl lithium; however, butyl-dithiacyclooctenes **232** and **233** (9%, 35%) were isolated as by-products thus demonstrating the high reactivity of alkyne **216** towards nucleophiles. A comparison of the spectroscopic data of **216** with those of **206** (Table 4) reveals a similarly strained ($\tilde{\nu}_{\text{C}\equiv\text{C}}=2190\text{ cm}^{-1}$, $\Sigma\delta_{\text{C}\equiv\text{C}}=184.7\text{ ppm}$) but significantly less polarized ($\Delta\delta_{\text{C}\equiv\text{C}}=13.7\text{ ppm}$) acetylenic unit.

Dehydrobromination of 2-bromo-1,4-dithiacyclooct-2-ene **234** was possible under phase-transfer conditions; the alkyne was trapped *in situ* with tetracyclone **4** (58% of **235**) (Scheme 35). In the absence of this reactive diene, a dimerization of **217** to tetrathiabicyclo[8.6.0]hexadecenyne **236** occurs.¹³³ An attack of the positively polarized S-1 on C-2 of the triple bond of a second molecule of **217** followed by a nucleophilic shift of the acetylene unit from S-1 of the first molecule to C-3 was proposed as a mechanism for this dimerization/ring enlargement.

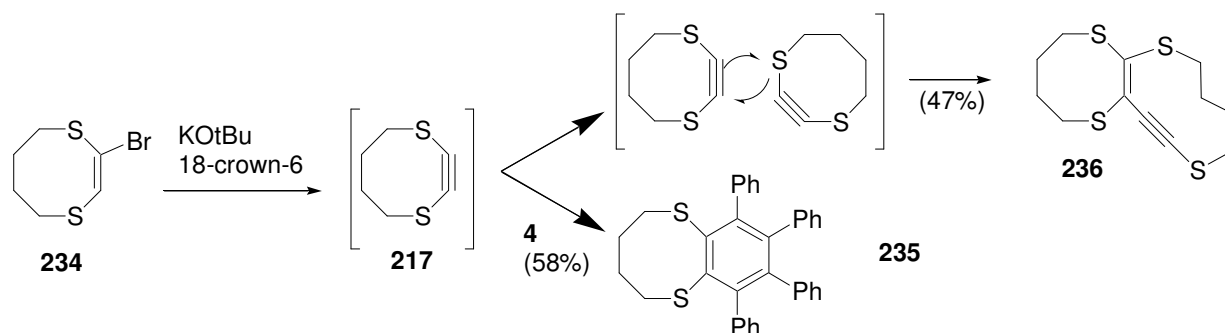

Scheme 35. Synthesis and dimerization of 1,4-dithiacyclooct-2-yne **217**.

A dithiacyclooctyne of type **215** and higher homologues had been reported by Ibis.¹³⁸ The reaction of pentachlorobutadiene **237** and α,ω -dithioles under basic conditions led to a series of dithiacycloalkenyne with ring sizes of 8 (**238**), 9 (**239**), and 12 (**240**) and a unique 1,6-dithia-2,3-dichloro-2-ene-4-yne motif (Scheme 36). A weak and not systematic influence of ring size on the acetylene stretching frequency has been observed: 12-ring: $\tilde{\nu}=2150\text{ cm}^{-1}$; 9-ring: $\tilde{\nu}=2160\text{ cm}^{-1}$; 8-ring: $\tilde{\nu}=2155\text{ cm}^{-1}$.

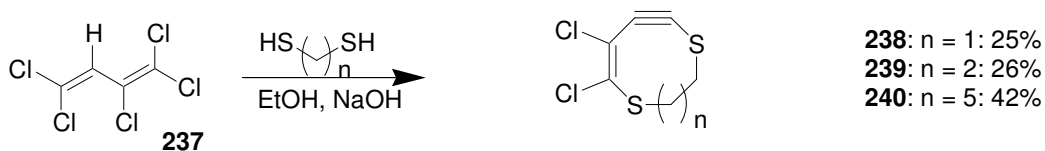

Scheme 36. Dithiacycloalkenyne **238–240**.

2,7-Dimethyl-2,7-dichloroocta-3,5-diyne **241** had been used to prepared expanded dithiaradialenes¹³⁹ by four S_{N}' -reactions with sodium sulfide (Scheme 37). Treatment of **241** with α,ω -dimercaptoalkanes yields bis-isopropylidene-cycloalkenyne **243–245** in reasonable yields (nine to twelve-membered rings, 42–60%).¹⁴⁰ Even the cyclooctyne **242** was obtained, but only in 8% yield.

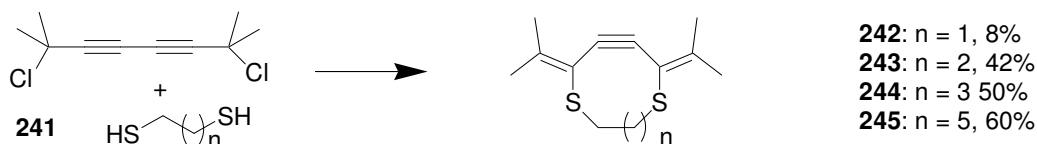

Scheme 37. Synthesis of bis-isopropylidene-dithiacycloalkenyne.

Besides the 1:1 cyclic dimers, also large ring cycloalkynes with a 2:2 combination have been isolated. The ten- and twelve-membered rings are assumed to be unstrained as indicated by the ^{13}C -NMR shifts of the *sp* carbons (**244**: $\delta=90.7$ ppm; **245**: $\delta=92.0$ ppm) which are typical for alkynes conjugated to olefins. With decreasing ring size, these signals suffer a typical strain-induced shift to $\delta=95.7$ ppm (**243**) and $\delta=100.8$ ppm (**242**).

5.4. Silacyclooctynes

A series of cyclic diynes **251–255** (Scheme 38) with a 1,5-hexadiyne moiety and a silicon-containing bridge was prepared by Gleiter.^{141,142} Ring closure of linear diynes **246–250** with terminal propargyl bromides or chlorides was performed by reaction with lithium in the presence of biphenyl at -20 °C, the yields of this reductive cyclization vary between 10% and 20%. The synthesis of the disilacyclooctadiyne **251** deserves special interest because it fills one gap between cycloocta-1,5-diyne^{143,74} and octamethyltetrasilacyclooctadiyne **143**. Furthermore, the synthesis of **251** demonstrates that this procedure is effective also for systems with considerable strain energy. The structure of **251** was determined¹⁴⁴ by X-ray diffraction: the eight-membered ring is almost planar, only the ethano bridge deviates slightly from the plane avoiding a fully eclipsed conformation. Furthermore, this study revealed a bending of the triple bond stronger at the Si_2Me_4 side (24°) than at the ethano side (*ca.* 11°) and bond angles close to those found in cyclooctadiyne (159°) and in **144** (168.6°). The PE spectrum of **251** shows a strong interaction between the in-plane π -orbitals and the Si–Si σ -bond. **251** and **253**, upon treatment with $\text{Cp}^*\text{Co}(\text{C}_2\text{H}_4)_2$ form Cp^*Co -stabilized cyclobutadieno superphanes (10%).¹⁴⁵ However, a similar reaction carried out with the sterically less demanding CpCo metal fragment results in the formation tri- and tetrameric beltens (20%–35%, respectively 8%–10%).

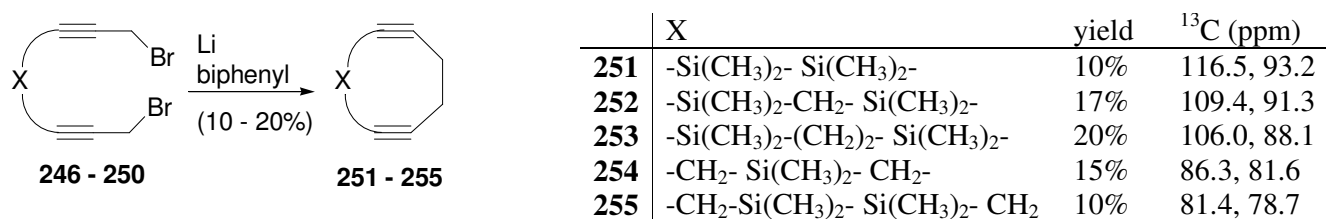

Scheme 38 and Table 6. Synthesis and ^{13}C -NMR data of sila-cycloalkadiynes.

Dodecamethyl-hexasilacyclooctyne **42** was prepared by the reaction of acetylene di-Grignard reagent with 1,6-dichlorohexasilane **256** in 46% yield (Scheme 39).⁹² Similar hexasilacyclooctynes **133** and **142** with different substituents on the 1,6- and 3,4-positions were obtained by Ando⁹⁵ *via* reductive coupling of bis(chlorodiphenylsilyl)acetylene **257** and 1,4-dichlorooctamethyltetrasilane **25** (or the tetramethyltetraethyl derivative **258**) in the presence of magnesium to yield 18% of **133** or 13% of **142** (Scheme 39).

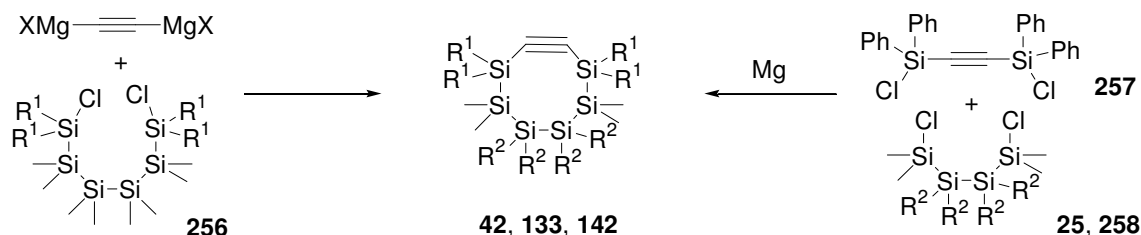

Scheme 39. Synthesis of hexasilacyclooctynes **42**: $\text{R}^1=\text{R}^2=\text{CH}_3$; **132**: $\text{R}^1=\text{Ph}$, $\text{R}^2=\text{CH}_3$;
142: $\text{R}^1=\text{Ph}$, $\text{R}^2=\text{C}_2\text{H}_5$; **25**: $\text{R}^2=\text{CH}_3$; **258**: $\text{R}^2=\text{C}_2\text{H}_5$.

Spectroscopic data of the acetylene group in **42** and **142** are similar, the ^{13}C -NMR resonances of the alkyne appear at $\delta=118.0$ and $\delta=117.6$ ppm, respectively and indicate a nearly unstrained ring system (*cf.* Table 1). Photolysis and pyrolysis of **42** gave the ring contracted **28** in *ca.* 20% yield (Scheme 20).^{20,92,93} This photochemical ring contraction follows two mechanisms that have been studied using **133** and **142** (see Scheme 22). Photolysis of pentasilacyclonona-4,8-diyne **143** (254 nm) resulted in ring contraction to yield octa-methyl-1,2,5,6-tetrasilacylooctadiyne **144** (10%).⁹⁷ The thermal elimination of dimethylsilylene (flash vacuum pyrolysis, 650 °C, 10^{-2} mmHg) led to the same product in 63 % yield (see Scheme 22). The synthesis of **144** from tetramethyl-dichlorodisilane and acetylene dianions (yield: 5%) has been reported by Kloster-Jensen.¹⁴⁶ Judging from the ^{13}C -NMR data of the acetylene units (Table 2), ring strain of diyne **143** is not very significant. Moreover, the molecular structure of the diyne, as determined by X-ray crystallography shows rather little distortion in both silane and acetylene units. The eight-membered ring is essentially planar with acetylene bond lengths of 1.182 Å and 1.183 Å and bond angles at the triple bond between 164.1° and 168.6°. Under the conditions of flash vacuum pyrolysis (680 °C, 10^{-2} mmHg) **144** underwent ring contraction to the seven-membered diyne **145** (6.3% yield, see Scheme 23).⁹⁷ DIBAL-H has been used to reduce **144** to the corresponding dienes with yields in the range of 15% to 22%.¹⁴⁷

A bicyclic tetrayne **261** composed of two cyclooctadiyne rings has been reported by West (Scheme 40).¹⁴⁸ The reaction of 1,2-diisopropyltetrachlorodisilane **260** with 2 equivalents of the di-Grignard reagent of 1,2-diethynyltetramethyldisilane **259** gave **261** in 22% yield. Two signals for the methyl groups on the non-bridged silicon atoms were observed in both ^1H - and ^{13}C -NMR spectra because the fused ring (*cis*- or *trans*-annulated) cannot be flipped. The acetylenic carbons give resonances at $\delta=112.4$ and 132.3 ppm and the lowest energy absorption in the UV region occurs at 260 nm, which is longer by 10 nm than that of the corresponding monocyclic compound **144** due to extended σ - π conjugation or destabilization of the HOMO resulting from greater ring strain. During the investigations on π -cages, Gleiter was able to detect several 1,4-disilacyclooct-6-yne **262–264** (Chapter 7.5, Figure 3) with an additional two- or four-carbon bridge.¹⁴⁹

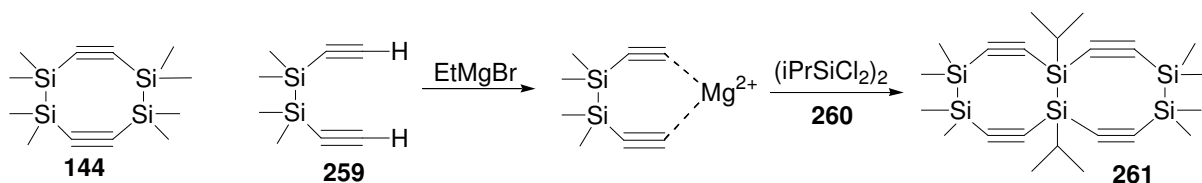

Scheme 40. Silacyclooctadiynes **144**, **261**.

6. Cyclononynes

6.1. Oxacyclononynes

Sterically constrained tolans have been prepared by Crisp¹⁵⁰ starting from compounds **265** and **266** (Scheme 41) by bridging the *o*-hydroxy groups on both rings with a dimethylsilyl or diphenylsilyl group to give benzo-annulated 1-sila-2,9-dioxacyclonon-5-yne **267–269**.

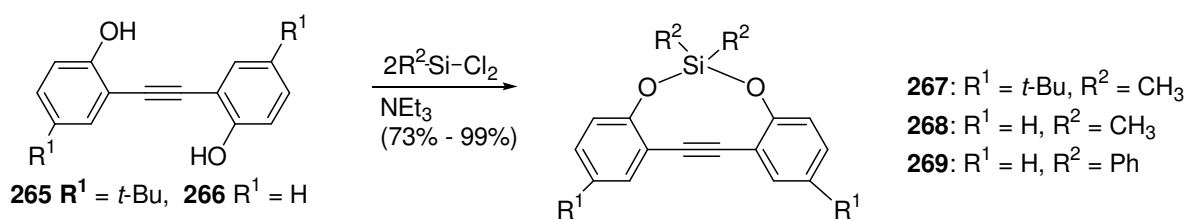

Scheme 41. Siloxane-bridged tolans.

Calculated geometries of these siladioxacyclononynes show a highly planar tolane unit with a small interplanar angle between the phenylene rings (2°) and a small but significant distortion of the alkyne unit (167°). Accordingly, ^{13}C -NMR signals of the alkyne unit are shifted to deeper field, **267**: $\delta=95.4$ ppm, **268**: $\delta=90.1$ ppm, **269**: $\delta=95.1$ ppm.

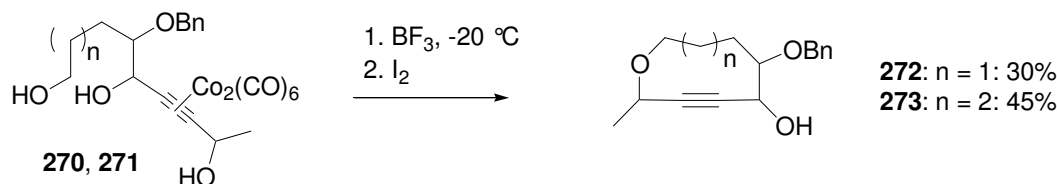

Scheme 42. Electrophilic cyclizations of cobalt-complexed propargylic alcohols.

Cyclic ethers have been prepared by formation of dicobalthexacarbonyl stabilized propargylic cations and intramolecular trapping of the cations by remote hydroxyl groups.¹⁵¹ This strategy has been successfully applied to the synthesis of nine- and ten-membered acetylenic ethers (Scheme 42). Oxidative removal of the cobaltcarbonyl activating/protecting group gave the substituted alkynes 1-oxacyclonon-3-yne **272** (30%) and 1-oxacyclodec-3-yne **273** (45%). Ligand exchange with phosphines is a mild method to release the free acetylene from a cobaltcarbonyl complex, *e.g.* **274** (Scheme 43); even *trans*-annulated 1-oxacyclonon-5-ene-3-yne **275** was obtained in 80% yield.¹⁵²

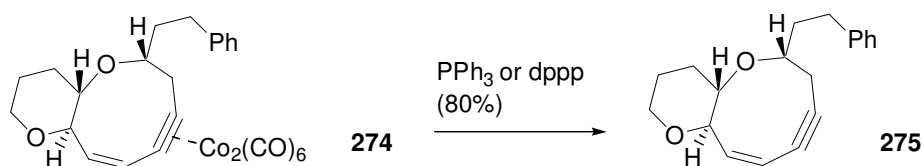

Scheme 43. Deblocking of $\text{Co}_2(\text{CO})_6$ -protected cycloalkyne **275** (dppp: 1,3-bis-diphenylphosphinyl-propane).

The intramolecular cyclization of a bromopropargyl substituted methylfuranone **276** was investigated for an advanced precursor of the AB ring of heliangolide sesquiterpenes like ciliarin (Scheme 44).¹⁵³ Even under optimized reaction conditions, the bicyclic oxacyclononyne **277** was obtained with yields not exceeding 21%. In this case, the combination of the nine-membered ring, an *anti*-Bredt enol ether^{154,155} and the *transoid* fixation of a part of the ring reduces the probability of cyclization.

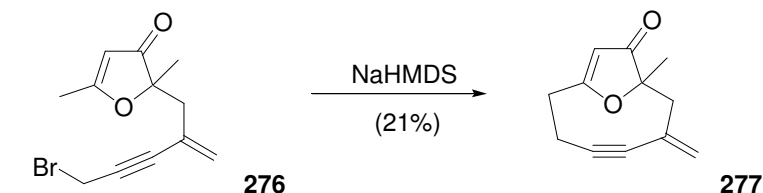

Scheme 44. Intramolecular cyclization to oxabicycloalkyne **277**.

Dimeric tetraorganodistannoxane **279** has been prepared and analyzed by Jurkschat (Scheme 45).¹⁵⁶ Two 1,3-distanna-5,8-disila-2-oxa-cyclonon-6-yne units are connected *via* Sn–O–Sn bonds to form a unique *cis*-ladder. In these complexes, the ^{13}C -NMR signals of the alkynes appear at $\delta=114.5$, 117.8 and 117.7 ppm. The cobalt-carbonyl complexes **280** and **281** of 1,3,5-trioxa-2,4-disilacyclononynes have been obtained as

by-products in the synthesis of dioxasilacycloheptynes (Scheme 9).³² Intramolecular Diels-Alder reactions (Scheme 25, Table 4) led to the formation of tricyclic lactone **162** with an oxacyclononyne unit.⁹⁹

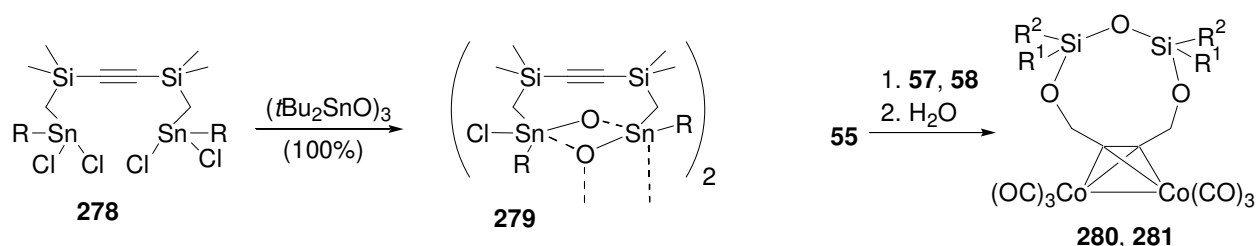

Scheme 45. Oxa-cyclononynes with silicon and tin as additional heteroatoms.

6.2. Azacyclononynes

Dicationic cycloalkynes, designed for interaction with DNA, were prepared by the reaction of **223** and α,ω -diamines (Scheme 46).^{157,158} Cyclization even with the formation of medium-sized rings occurred in excellent yields, the bis-azoniacyclononyne **282** was obtained in 89% and the ten-membered ring **283** in 90% yield. The acetylenic carbons give ¹³C-NMR signals at $\delta=79.0$ and $\delta=81.4$ ppm, respectively. Anion metathesis of these salts with phosphoric acid gives the corresponding phosphates that are liquid at or near room temperature.¹⁵⁹

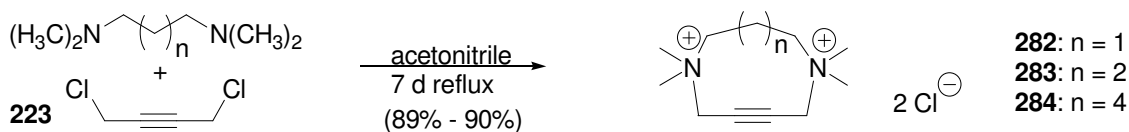

Scheme 46. Bis-azoniacycloalkynes.

Nine- and ten-membered 1-aza-1,3-dien-5-ynes **287** and **288** were designed¹⁶⁰ as precursors for the generation of 1,4-diradicals *via* aza-analogous Hopf-cyclization.^{161,162} These cycloalkynes with an imine unit have been obtained by intramolecular aza-Wittig reactions of alkynyl-benzaldehydes with a terminal azide (**287**: $n=1$; **288**: $n=2$, Scheme 47). Incubation of aza-yne **287** at 37 °C initiated a smooth conversion to a dihydroisoquinoline **289** ($n=1$, 100%). The same reaction for the higher homologue **288** required 50 °C (45%) with formation of **290**. Incubation of the more reactive **287** with DNA led to a moderate cleavage of DNA after 48 hours. A tricyclic lactame **149** with an azacyclononyne ring has been converted to a bicyclic lactame **153** and to an annulated azacyclononyne **157** in very good yields (Scheme 24, Table 3).⁹⁹

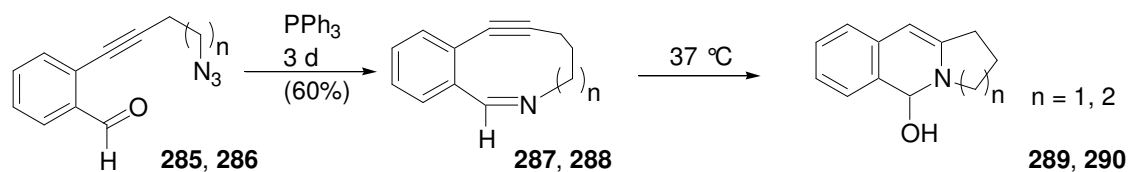

Scheme 47. Formation of azacyclononadienyne **287** and **288** and Hopf-cyclization.

The copper(II) catalyzed alkylation of amides is one of the preferred routes to ynamides. The utility of this procedure for the formation of cyclic ynamides has been demonstrated by Hsung¹⁶³ by several intramolecular alkylations of esters with a terminal ω -bromoalkyne and a Cbz-protected amino group on the other end to yield lactones incorporating an ynamide unit (Scheme 48). Whereas the formation of the

9-(**296**), 11-(**297**) and 13-(**298**) membered rings proceeded with 76% to 90%, the yields dropped to moderate 42% and 45% for the macrocycles (15-, 19-ring: **299** and **300**). Reduction of conformational flexibility by annulation of a binol moiety significantly improves the outcome (70%) of the cyclization step even for a 16-ring ynamide **301**. The wave number of the alkyne stretching vibration decreases with the ring size, **298**: $\tilde{\nu}=2259\text{ cm}^{-1}$, **296**: $\tilde{\nu}=2237\text{ cm}^{-1}$.

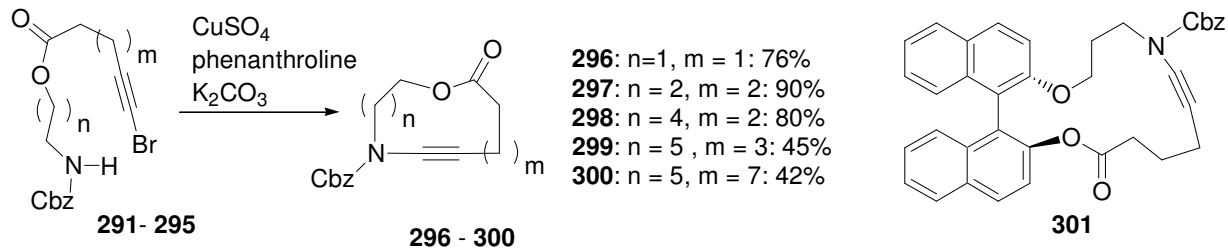

Scheme 48. Intramolecular formation of ynamides.

6.3. Thiacyclononynes

The cesium effect had been essential for the synthesis of dithiacyclooctyne **220** (Scheme 33) and assisted in the analogous cyclizations leading to 1,6-dithiacyclonon-3-yne **227** (33%) and 1,7-dithia-4-oxacycloundec-9-yne **228** (33%). Remarkably high yields of 75% to 100% of dithiacyclononynes were obtained in cyclizations of 1,4-dichlorobut-2-yne **223** with dithiols under high dilution conditions (ethanol, KOH) (Scheme 49).^{134,135} A series of medium-sized dithiacycloalkynes has been prepared by Went and used as ligands in complexes of molybdenum, copper, silver and mercury.¹⁶⁴

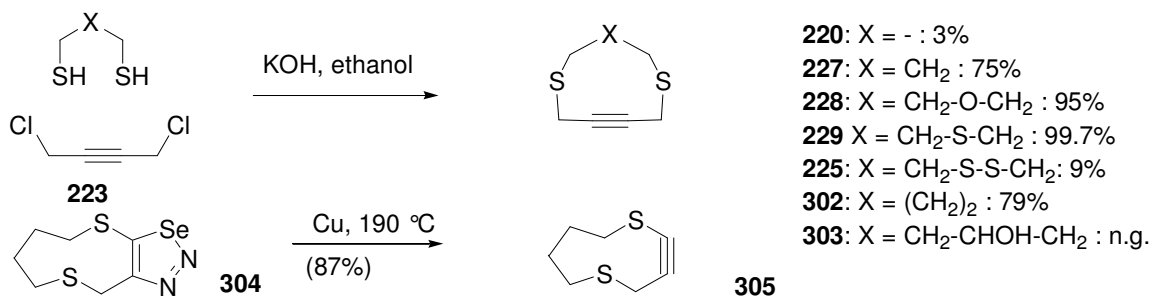

Scheme 49. Synthesis of di- and trithiacyclononynes.

Dichlorodithiacyclononyne **239** has been obtained in an addition/elimination cascade¹³⁸ from pentachlorobutadiene and 1,3-dimercaptopropane (Scheme 36). Alkynyl thioether **305** was obtained in very good yield by thermal fragmentation of selenadiazole **304** (Scheme 49). A comparison of the spectroscopic data of 1,5-dithiacyclonon-2-yne **305** ($\tilde{\nu}_{\text{C}\equiv\text{C}}=2280\text{ cm}^{-1}$, $^{13}\text{C-NMR}$: $\delta=80.4, 92.5\text{ ppm}$) with those of its isomer **227** ($\tilde{\nu}_{\text{C}\equiv\text{C}}=2245\text{ cm}^{-1}$, ^{13}C : $\delta=86.5\text{ ppm}$) reveals a similar effect of the only moderate ring strain on the NMR signals ($\Sigma\delta=172.9$ vs 173.0 ppm). The polarization in the alkynyl thioether segment in **305**, as judged by $\Delta\delta=12.1\text{ ppm}$, is nearly as high as in the smaller homologue **216** ($\Delta\delta=13.7\text{ ppm}$). The synthesis and properties of medium-sized bis-isopropylidene-dithiacycloalkynes like **243** have been discussed in Chapter 5.3 (Scheme 37).

A Lewis-acid-catalyzed addition of sultene **306** to 1,5-dithiacyclonon-7-yne **227** has been observed by Adam (Scheme 50).¹⁶⁵ The Lewis-acid opens the sultene ring and by addition of the alkyne, a thiirenium ion is formed. Ring opening of the thiirenium ion to an α -thionocarbene is followed by attack of the neighboring

thioether to result in a ylide, which by ring opening leads to the exocyclic methylene group. The final spirocyclic adduct **307** is obtained by nucleophilic attack of the juxtaposed oxygen atom with simultaneous release of the Lewis acid.

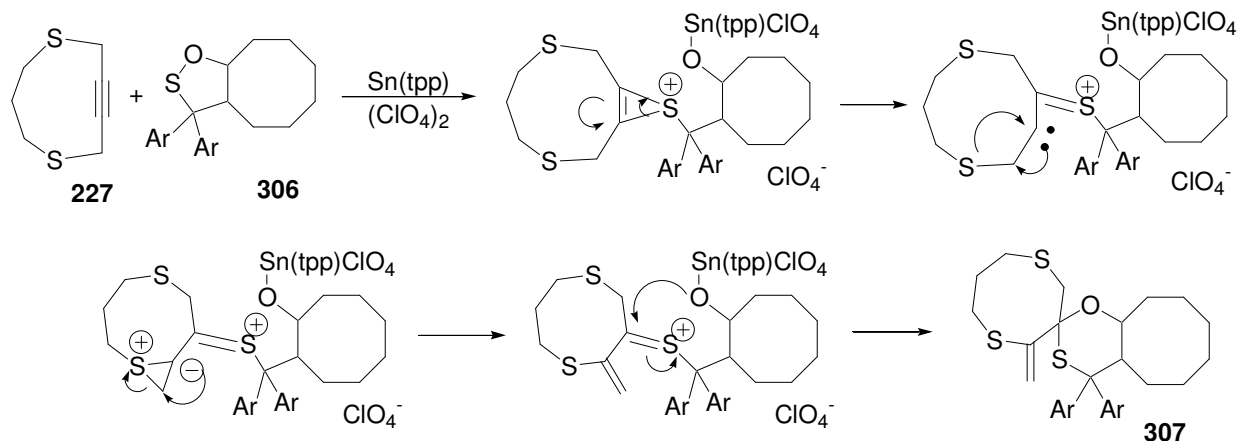

Scheme 50. Lewis-acid catalyzed addition of sultene **306** to dithiacyclononyne **227**.

As an intermediate in the total synthesis of griseoviridin, 1-thia-4-oxacyclonon-8-yne-3-one derivative **309** was prepared *via* Mitsunobu esterification of the ω -hydroxycarboxylic acid **308** in 50% yield (Scheme 51).¹⁶⁶ The alkyne valence vibration frequency is $\nu=2184\text{ cm}^{-1}$ and the $^{13}\text{C-NMR}$ signals of the acetylene appear at $\delta=80.3, 97.3\text{ ppm}$, thus indicating a significantly higher ring strain and alkyne polarization than in **305**.

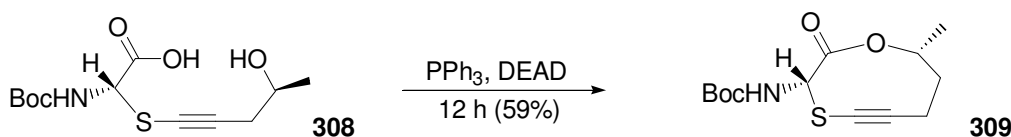

Scheme 51. Mitsunobu cyclization to thiacyclononyne **309**.

6.4. Silacyclononynes

The synthesis of 1,1-dimethyl-1-silacyclonona-3,7-diyne **254** (15%, $^{13}\text{C-NMR}$: $\delta=86.6, 81.3\text{ ppm}$) and 1,1,3,3-tetramethyl-1,3-disilacyclonona-4,8-diyne **252** *via* reductive cyclization (17%, $^{13}\text{C-NMR}$: $\delta=109.4, 91.3\text{ ppm}$) of linear bis-propargyl bromides or chlorides is shown in Scheme 38.^{141,142} The same reductive cyclization carried out on **246** (as dichloro derivative, $\text{X}=-[\text{Si}(\text{CH}_3)_2]_2-$) and in the presence of dimethyl-dichlorosilane resulted in a cross-coupling to yield hexamethyl-1,2,6-trisilacyclononadiyne **310** (17%, $^{13}\text{C-NMR}$: $\delta=109.9, 84.2\text{ ppm}$; $\tilde{\nu}=2147, 2053\text{ cm}^{-1}$).¹⁴² Strain reduces the bond angles at the *sp* carbon atoms to 164° and 171.2° , the short transannular distance of 2.734 \AA between the termini of the heptadiyne moiety allows an electronic interaction as demonstrated by PES. The related 1,1,2,2-tetramethyl-1,2-disilacyclonona-3,8-diyne **312** has been prepared from lithiated 1,6-heptadiyne **311** and tetramethyl-1,2-dichlorodisilane in 10% yield ($^{13}\text{C-NMR}$: $\delta=114.8, 88.1\text{ ppm}$; IR: $\tilde{\nu}_{\text{C}\equiv\text{C}}=2157\text{ cm}^{-1}$).¹⁶⁷

Gleiter used **254**, **312** and 1,4-disilacyclodeca-5,9-diyne **253** for the synthesis cobalt-capped cyclobutadienes with annulated disilacycloalkynes like **313** (Scheme 52).^{167,168} Twofold sila-bridged superphanes such as **314** were obtained by reaction of these bis-cycloalkynes **313** with a second molecule of $\text{CpCo}(\text{COD})$ or directly from the diynes **254**, **312**, **253** and two equivalents of the cobalt reagent. It should be noted that, in all cases, only the compounds with the bulky silyl groups adjacent to each other were found.

5,5,6,6-Tetramethyl-5,6-disila-1-thiacyclonona-3,7-diyne **315**, the thia-analogue of **312**, reacts with octacarbonyl dicobalt to afford 83% of the bis-(hexacarbonyl dicobalt) complex.¹⁶⁹ In the solid state, cobalt-heteroatom interactions have been found which can be important in Pauson-Khand reactions.¹⁶⁷

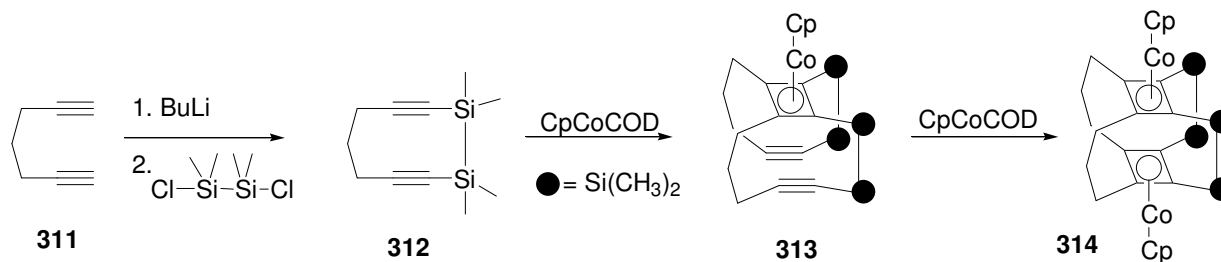

Scheme 52. Synthesis of disilacyclonadiyne **312** and successive transformation to superphane **314**.

Cyclization of the di-Grignard reagent from 1,2-diethynyl-1,1,2,2-tetramethyldisilane **259** with 1,3-dichlorohexamethyltrisilane gives the pentasilacyclonadiyne **316** in 37% yield.⁹⁷ The same sequence applied to 1,5-hexadiyne gave 1,1,2,2,3,3-hexamethyl-1,2,3-trisilacyclonona-4,8-diyne **317** that had been claimed as a source for dimethylsilylene (Scheme 53).¹⁷⁰ Photolysis of **316** led to octamethyl-1,2,5,6-tetrasilacyloctadiyne **143** (10%) *via* elimination of dimethylsilylene,⁹⁷ the same product was obtained in 63 % yield by flash vacuum pyrolysis (650 °C, 10⁻² mmHg) (Scheme 23).

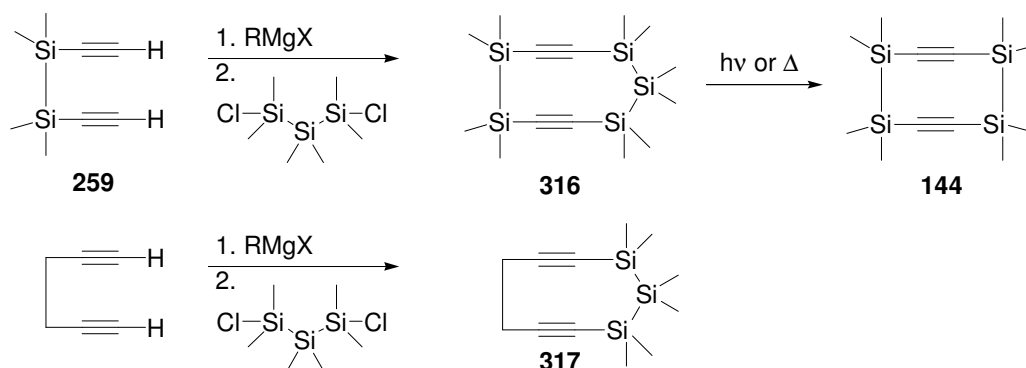

Scheme 53. Cyclization to tri- and pentasilacyclonadiyne **316** and **317** and ring contraction.

6.5. Pericyclynes

DFT studies on [3]chalcogena[3]pericyclynes demonstrated that they are local minima on their potential energy surface possessing a singlet ground state.¹⁷¹ Nevertheless, substantial strain is predicted by the calculated bond angles at the *sp* carbon atoms of 159.4° in trioxacyclononatriyne **318** and 164.2° in tri-thiacyclononatriyne **319**, 164.9° in the triselana derivative **320** and 171.9° in the tritellura compound **321** (Scheme 54).

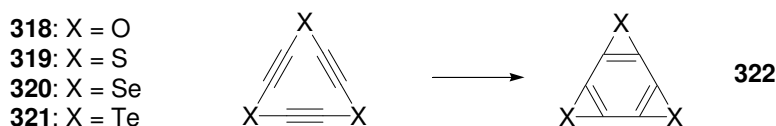

Scheme 54. Chalcogena-[3]pericyclynes and cyclization to tris-annulated benzenes **322**.

In the case of the compounds with heavier chalcogens, a benzene-like structure **322** was calculated to be more stable than the acetylenic one. These might be formed from the pericyclynes *via* an allowed

$[\pi_s^2+\pi_s^2+\pi_s^2]$ cycloaddition process. Also the geometry and properties of the 12-membered tetraiodonium[4]pericyclyne **323** have been studied theoretically.¹⁷² Whereas the trichalkogena[3]pericyclynes are still unknown, a triphospha- and a trisila[3]pericyclyne have been reported so far.

Dodecamethyl-1,2,5,6,9,10-hexasilacyclododeca-1,5,9-triynes **325** has been prepared by stepwise coupling of alkynyl Grignard reagents and 1,2-dichlorodisilanes with a 28% yield in the final cyclization step¹⁷³ and has been observed as a by-product in the synthesis of larger disiladiynes (Scheme 55).¹⁷⁴ Upon heating triyne **325** to 200–300 °C, ring contraction occurs *via* stepwise extrusion of dimethylsilylene to form pentasilacycloundecatriyne **326**, tetrasilacyclodecatriyne **327** and finally trisilacyclononatriyne **328**.¹⁷³ Pyrolysis of the 12-membered ring **325** at 540 °C gave a mixture of all three products in low yields. The same experiment carried out under more forcing conditions (690 °C) afforded trisila[3]pericyclyne **328** as single product in 68% yield. This compound is thermally and oxidatively stable and adds three molecules of α -pyrone to give tris-bridged cyclophane **329** (55%).

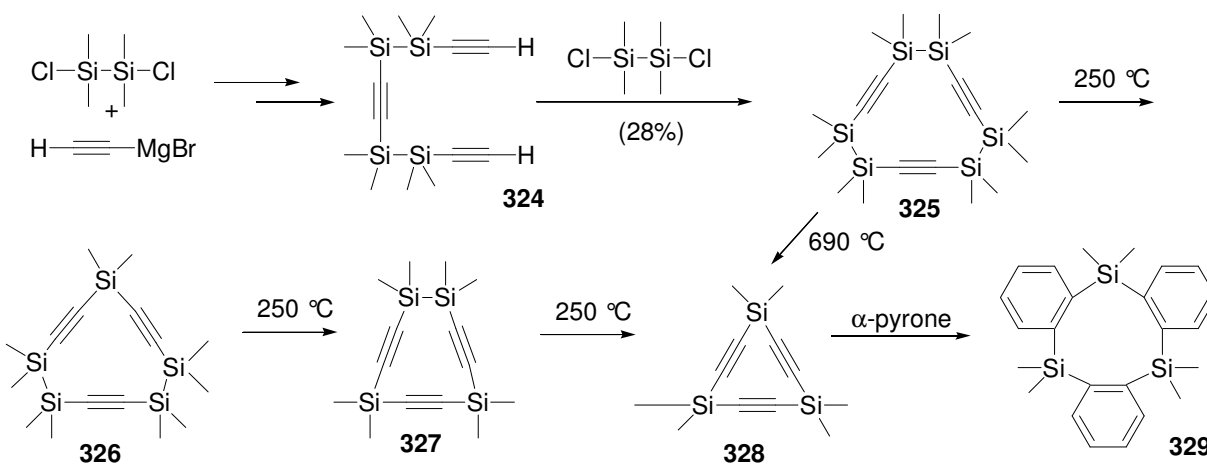

Scheme 55. Formation of trisila[3]pericyclyne **328** *via* ring contraction and addition to α -pyrone.

Phosphapericyclynes have been obtained by Scott¹⁷⁵ by iterative coupling of ethynyl Grignard reagents and *t*-butylphosphonous dichloride **330** (Scheme 56). Twofold deprotonation of diphosphatriyne **331** and reaction with **330** produced the nine-membered heterocycle **333** in 16% yield.

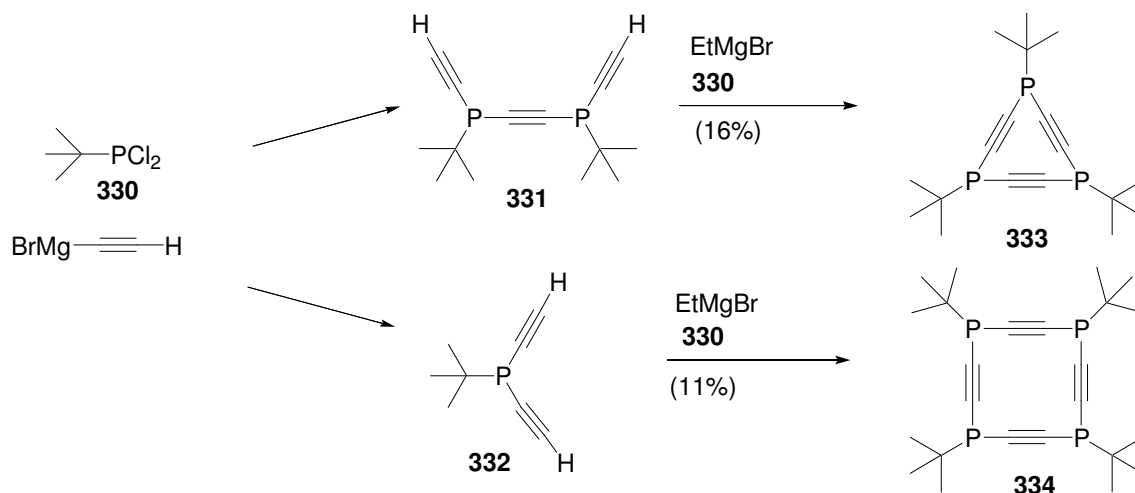

Scheme 56. Formation of triphospha[3]pericyclyne **333** and tetraphospha[4]pericyclyne **334**.

Similarly, two deprotonated phosphadiynes **332** and two equivalents of **330** gave the 12-membered ring **324** in 11% yield. NMR spectroscopy and single crystal X-ray diffraction established the *cis,trans* configuration of **333**, no evidence for equilibration of the *cis,trans* with the *all-cis* diastereomer by inversion of phosphorous at temperatures up to 50 °C has been found. *All-trans*-**334** has been isolated from the mixture of the four stereoisomers of **334**, the stereochemistry of which has been determined by X-ray crystallography. Both compounds exhibit strong absorption bands, nearly extending to $\lambda=300$ nm due to a significant cyclic electronic interaction.

7. Cyclodecyne

The deformation of the bond angles at the triple bond in cyclodecyne is generally less than 10°. Therefore, according to a somewhat arbitrary definition, these compounds are not regarded as “angle-strained” cycloalkynes.⁷ However, the deviations from ideal geometry and even more the highly interesting chemistry of several compounds justify a cyclodecyne section. Due to the importance of 1-hetero- and 1,6-diheterocyclodeca-3,8-diynes, these compounds are collected in a separate chapter.

7.1. Oxacyclodecyne

Sterically constrained tolanes **337** (R=H) and **338** (R=*t*-Bu) have been prepared by Crisp¹⁵⁰ by bridging the *o*-positions of their precursors **335** and **336** by a Mitsunobu reaction (Scheme 57). The ¹³C-NMR signals of the triple bond appear at $\delta=95.4$ ppm (for **337**) and $\delta=95.5$ ppm (for **338**), very similar to the related compound **267** with a dimethylsilylene bridge (Scheme 41). The highfield shift ($\delta=91.2$ ppm) observed for the alkyne resonance of the analogous eleven-membered ring compound **339** bearing a 1,3-propylene tether, when compared with **337** and **267** indicates a release in ring strain. Dibenzo-1,6-dioxacyclodeca-2,4-dien-8-yne **340** was prepared by cycloalkylation of 2,2'-dihydroxybiphenyl and 1,4-dichlorobut-2-yne **223** in 34% yield (Scheme 58).¹⁷⁶ Similarly to other propargyloxybenzenes, a Claisen rearrangement occurs in the presence of silver trifluoroacetate. After 4 hours at 61 °C, the ring-contracted allene derivative **341** was isolated in 92% yield.

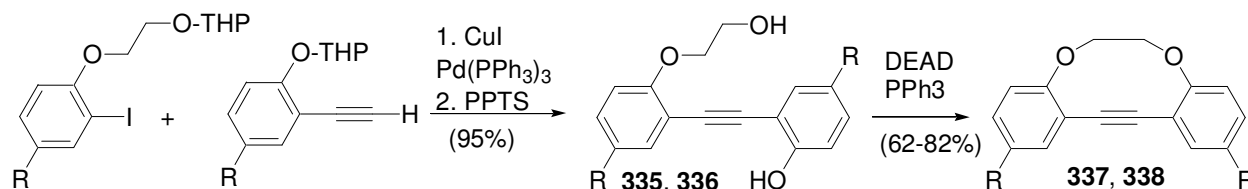

Scheme 57. Sterically constrained tolanes.

Bridging a (*R*)-binol derivative by nucleophilic substitution with 1,4-dichlorobut-2-yne **223** gave the annulated 1,6-dioxacyclodec-3-yne **342** (37%) (Scheme 58). Diederich used this rigid tether for geometrical optimization of 1,1'-binaphthylene receptors for enantioselective molecular recognition.¹⁶⁴ Compound **273**, another member of the ten-membered propargylic ethers,¹⁵² has been obtained by cyclization of the alkyne-cobalt complex and oxidative removal of the metal fragment (45%, Scheme 42). However, more investigated than the ethers are the acetylenic lactones having the same ring size.

Ten-membered acetylenic lactones **347** and **348** and higher homologues have been prepared from oxabicycloalkenones **343** and **345** and homologues *via* fragmentation of their tosylhydrazones **344** and **346** in 65–90% yield (Scheme 59).¹⁷⁸ Lindlar hydrogenation gave the corresponding *Z*-alkenes.¹⁷⁹

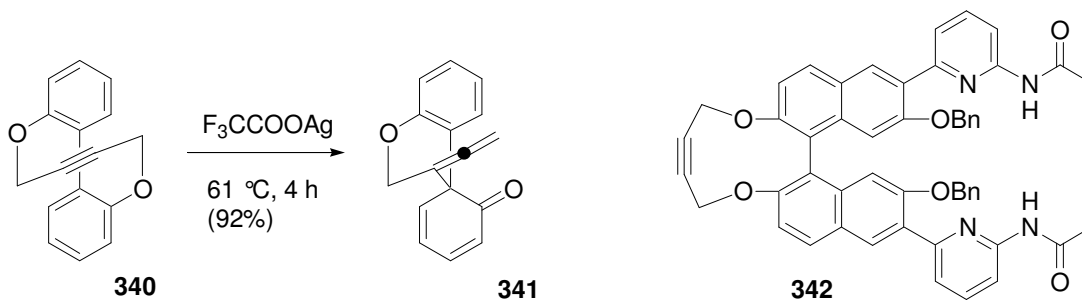

Scheme 58. Butynyl-bridged dihydroxybiaryls.

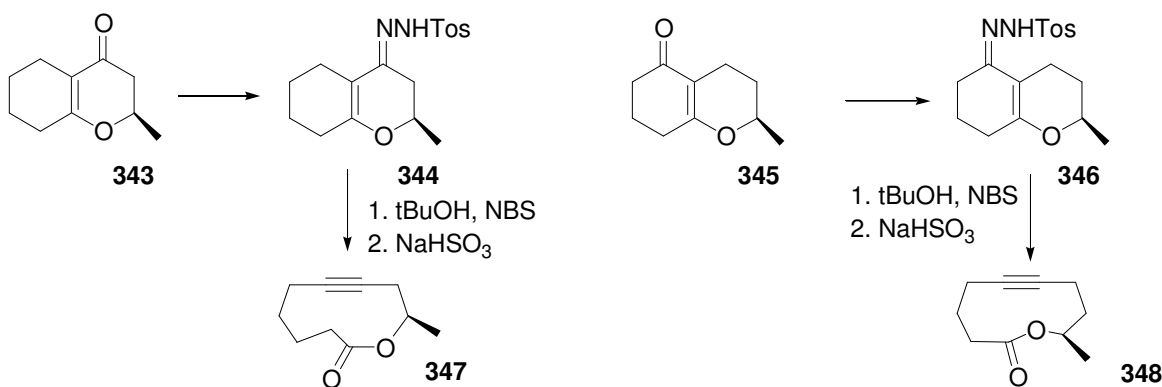

Scheme 59. Tosylhydrazone fragmentation to medium-sized acetylenic lactones.

Thermolysis of alkynyl ethyl ethers such as **349** gives ketene intermediates of the type **350** *via* retro-ene reaction; these can be subsequently trapped by a remote hydroxyl group to produce lactones as **351** (Scheme 60). This reaction required the aid of butylamine for the synthesis of medium-sized lactones,¹⁸⁰ *e.g.* the ten-membered acetylenic lactone **351** (¹³C-NMR: $\delta=86.9, 76.1$ ppm; IR: $\tilde{\nu}=2236$ cm⁻¹) was obtained in 50% yield.

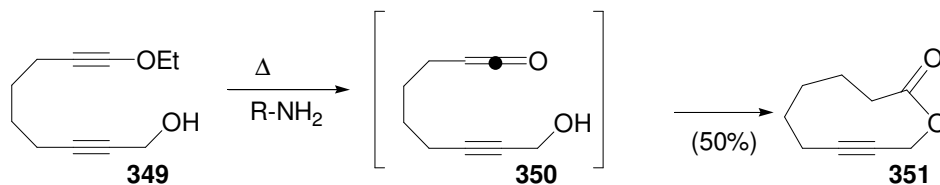

Scheme 60. Ketene formation and intramolecular addition of a terminal alcohol.

The formation of a bicyclic acetylenic lactone was a key step in Inanagas total synthesis of neome-thynolide.^{181,182} Whereas the *seco*-acid having an axial methoxyl group had almost no chance of intra-molecular cyclization, it was possible to lactonize the *seco*-acids **352** and **353** having an equatorial methoxyl group at C-7 (Scheme 61).

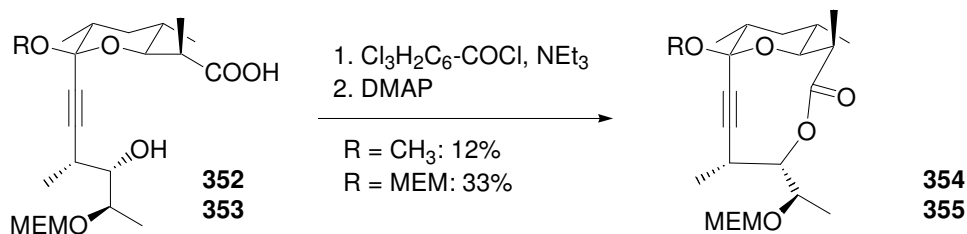

Scheme 61. Bicyclic propargylic ether *via* lactonization.

Nevertheless, the cyclization suffers from the generation of considerable ring strain; in fact, the yield is 12% for the methoxyl derivative **354** but 33% for the analogous MEM ether **355**.

Yields of lactonization reactions of cobalt-complexed acetylenic ω -hydroxy acids are generally only moderate, but this is the typical problem of the formation of medium-sized rings, not of the formation of a cycloalkyne. Bending the triple bond by complexation with cobalt as in **356** and a Mukaiyama lactonization afforded the cyclodecyne-lactone **357** in comparable 22% yield (Scheme 62).³¹

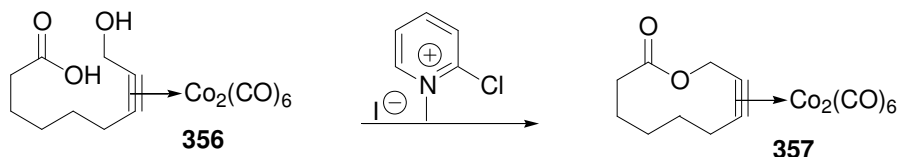

Scheme 62. Lactonization of the cobalt-complexed acetylenic ω -hydroxy acid **356**.

Lactone formation is not limited to reactions forming the ester bond. Medium-sized lactones were also obtained by cyclizations of alkenyl di- and trichloroacetates *via* Cu-catalyzed transfer of a chlorine radical.¹⁸⁴ The rigidity of the acetylenic tether in **358** and **359** allows the formation of chlorinated ten-membered lactone **360** in 36% yield and that of the eleven-membered homologue **361** in only 10% yield (Scheme 63).

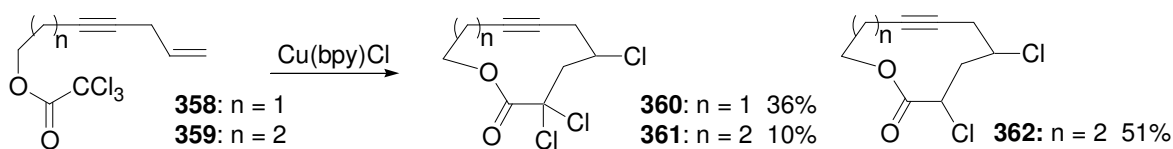

Scheme 63. Cu-catalyzed radical cyclization to acetylenic lactones.

The same reaction on the dichloroacetyl derivative of **359** afforded the 11-ring lactone **362** in 51% yield. Ring strain in these compounds is only small: the sums of the $^{13}\text{C}(sp)$ -NMR shifts of the ten-membered lactone **360** ($\delta=81.1, 82.6$ ppm; $\Sigma\delta=163.7$ ppm) and lactone **351** ($\Sigma\delta=163.0$ ppm) are only marginally higher than of the eleven-membered **361** ($\delta=76.7, 83.1$ ppm; $\Sigma\delta=159.8$ ppm) and its dichloro derivative **362** ($\delta=76.9, 84.5$ ppm; $\Sigma\delta=161.4$ ppm). Intramolecular Diels-Alder reactions^{99,100} of a pyrone linked *via* an acetylene to an acrylate group led to the formation of tricyclic lactone **163** with a ten-membered lactone as subsystem (Scheme 25, Table 4).

7.2. Azacyclodecyne

Azacyclodecyne **286** (Figure 2) has been obtained¹⁶⁰ *via* an intramolecular aza-Wittig reaction (Scheme 47). Its thermal treatment results in a slow aza-analogous Hopf-cyclization. Dicationic diazacyclodecyne **283** has been prepared by alkylation of a diamine with 1,4-dichlorobut-2-yne **223** (Scheme 46).^{157,158}

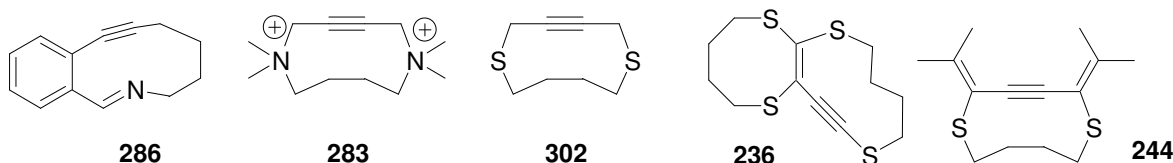
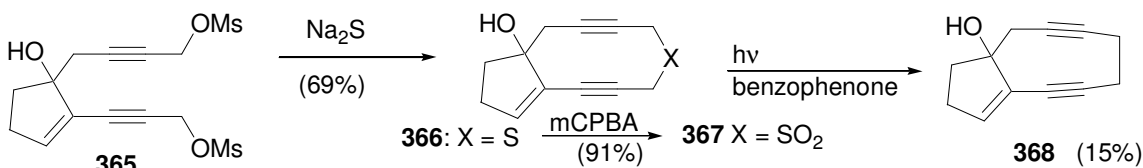

Figure 2. Aza- and thiacyclodecyne.

Tricyclic lactame **167** resulted from an intramolecular Diels-Alder reaction. This and the bicyclic lactame **170** and the corresponding amine **173** contain an aza-cyclodecyne fragment (Scheme 25, Table 4).

7.3. Thiacyclodecyne

The solid state structure of 1,6-dithiacyclodec-3-yne **302**, prepared by cyclization of dichlorobutyne **223** and 1,4-butanedithiol in 79% yield (*cf.* Scheme 49), was established by X-ray diffraction.¹³⁴ The molecule adopts a C₂ conformation with an acetylene bond length of 1.174 Å and bond angles at the *sp* carbons of 167.9° and 168.7°. This deformation is higher than predicted by MM+ calculations (bond angle: 169.7°). Compound **302** reacts with AgBF₄ and CuPF₆ to form the 1:1 complexes **363** and **364**.¹⁶⁴ In these complexes, the ¹³C-NMR signal of the free alkyne **302** ($\delta=80.3$ ppm) is nearly unbiased by complexation: **363** and **364**: $\delta=81.2$ ppm. 1,6-Dithiadec-2-ene-4-yne **236** with an annulated dithiacyclooctene ring resulted from the dimerization of **217** (Scheme 35).¹³³ A comparison of the spectroscopic data (¹³C-NMR: $\delta=88.0$, 95.5 ppm; IR: $\tilde{\nu}=2150$ cm⁻¹) of **236** with structurally related **244** and **245** (Scheme 36) indicates only minor effects of ring strain. In the course of the synthesis of the neocarcinostatin chromophore, Wender¹⁸⁵ succeeded in the ring closure of a thiacyclodecadiyne **366** (Scheme 64).



Scheme 64. Synthesis of thiacyclodecadiyne **366** and oxidation to acetylenic sulfone **367**.

Oxidation of this unstable compound with mCPBA gave the sulfone **367** (91%). The signals of all *sp*-carbon atoms of **367** appear at $\delta=83$ –85 ppm. Upon irradiation of **367** in the presence of benzophenone, extrusion of SO₂ occurred to give the ring-contracted enediyne **368**. A similar sequence has been used for the synthesis of 1-thia-cyclodec-5-en-3,7-diyne **370** (Scheme 65). In the solid state, the enediyne segment (C-2–C-9) is essentially planar; only the -CH₂S- fragment is twisted out of this plane. The acetylenic bond angles of 176°, 165°, 163° and 176° indicate some ring strain and the distance of 3.30 Å between the terminal carbon atoms of the enediyne falls in the critical range for ring closure *via* Bergman cyclization. Indeed, heating this compound in the presence of 1,4-cyclohexadiene results in the formation of isothiochromane **372** (18 hours, 80 °C: 58%).¹⁸⁶

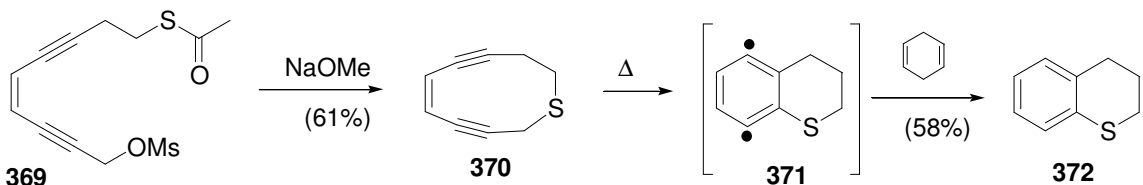

Scheme 65. Formation of **370** and Bergman cyclization.

7.4. 1,6-Diheterocyclodeca-3,8-diyne

In 1929 Lespieau³ reported that dichloromethyl ether **373** on reaction with acetylenedimagnesium bromide yielded *ca.* 2% of 1,6-dioxa-3,8-cyclodecadiyne **374**, a ten-membered heterocyclic diacetylene (Scheme 66).

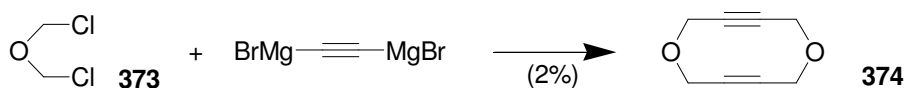

Scheme 66. Synthesis of the first heterocyclic alkyne.

This work has later been discounted¹⁸⁷ or else disregarded¹⁸⁸ until Sondheimer¹⁸⁹ conclusively showed that the structural assignment of Lespieau was correct and that the credit for preparing the first cyclic acetylene must be given to this investigator. Sondheimer observed a weak band at $\lambda=4.75 \mu$ ($\tilde{\nu}=2105 \text{ cm}^{-1}$) for the acetylene $\text{C}\equiv\text{C}$ vibration. The chair conformation was identified by X-ray diffraction. Lindlar hydrogenation led to the *cis,cis*-diene while hydrogenation over platinum yielded 1,6-dioxacyclodecane. Diyne **374** was the first member of the 1,6-diheterocyclodeca-3,8-diyne, a class of diynes that has been intensively investigated by Gleiter. As their synthesis, spectroscopic properties and reactions have been comprehensively summarized by Gleiter in 1992,¹⁹⁰ this chapter presents only selected information on this class of cycloalkynes.

A broad range of analogous diynes **375–405** has been prepared (Scheme 67, Table 7) and studied resulting in a wealth of surprising chemical reactions originating from the proximity of parallel triple bonds in these diynes.

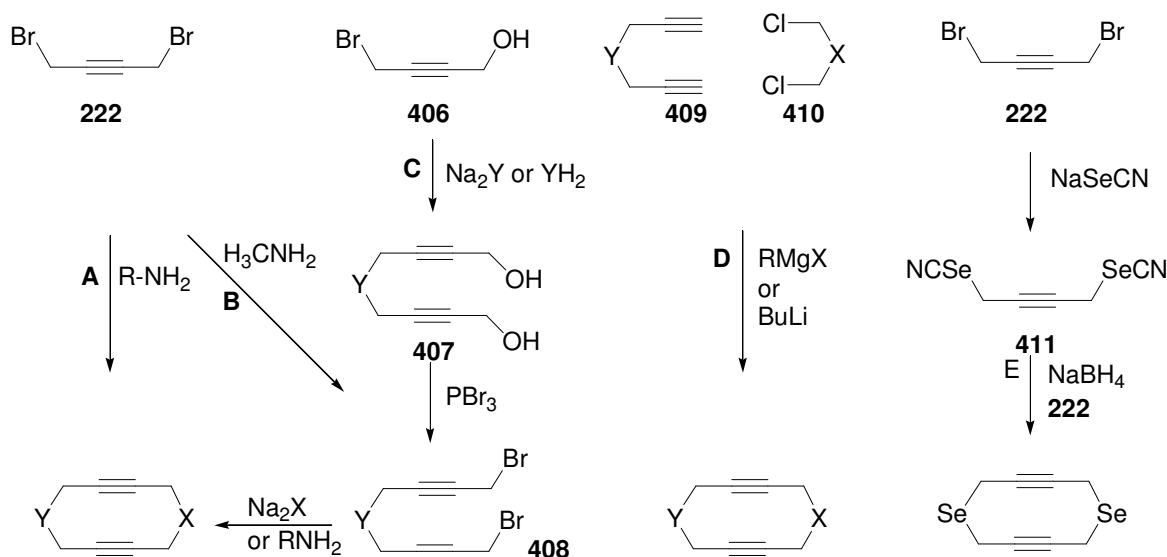

Scheme 67. Synthetic routes to heterocyclic decadiynes.

All heterocycles except **377** have been prepared from linear precursors, but contrary to their structural similarity, four main pathways have been applied. All include the cyclization of a diyne as the final step. Though rings with low strain energy are generated from molecules with limited conformational flexibility, the yields rarely exceed 20%. The stepwise twofold alkylation of a nucleophile (Na_2S , $\text{R}-\text{NH}_2$, Na_2Se , $(\text{Bu}_3\text{Sn})_2\text{S}$) with 1,4-dibromobut-2-yne **222** (A, B) or with 4-bromo-4-butyn-1-ol **406** and ring closure in the last step (B, C) is the typical strategy for the synthesis of 1,6-diheterocyclodeca-3,8-diyne (Scheme 67). Under high dilution conditions, the Misumi coupling (E) of **222** and the biselenocyanate **411** afforded the diselena-compound **398** in 46% yield.¹⁹¹ A very good yield of 80% was obtained in the thiacyclization of bis(propargyl bromide) **408** ($\text{Y}=\text{Tos}-\text{N}$) with $\text{Na}_2\text{S}\cdot\text{Al}_2\text{O}_3$. With this reagent, S_{N}' reactions on 2,7-dimethyl-2,7-dichloroocta-3,5-diyne **241** (*cf.* Scheme 37) afforded the expanded dithiaradialene **412** in 10% yield.¹³⁹

Coupling of α,ω -deprotonated 1,6-heptadiynes **409** with 1,3-dichloro compounds **410** (X=O (**356**); X=C=C(CH₃)₂) is the common route to oxa- and isopropylidene-cyclodecadiynes.

Table 7. 1,6-Diheterocyclodeca-3,8-diynes F: reductive (cross)-coupling, see Schemes 36; G: dealkylation of **382** with α -chloroethylchloroformate.

	X	Y	Route	δ_{CC} = (ppm)	Ref.
374	O	O	D	87.1	3, 191
375	O	CH ₂	D	90.1, 80.4	191
376	O	S	C, D	84.4, 82.7	191
377	N-H	N-H	G	85.6	192
378	N-CH ₃	N-CH ₃	A	82.2	192, 193
379	N-C ₂ H ₅	N-C ₂ H ₅	A	82.2	192, 193
380	N-CH(CH ₃) ₂	N-CH(CH ₃) ₂	A	82.7	192, 193
381	N- <i>cyclo</i> -C ₆ H ₁₁	N- <i>cyclo</i> -C ₆ H ₁₁	A	83.1	192, 193
382	N-C(CH ₃) ₃	N-C(CH ₃) ₃	A	85.8	192
383	N-Ph	N-Ph	A	82.7	192
384	N- <i>p</i> -tolyl	N- <i>p</i> -tolyl	A	82.8	192
385	N-CH ₃	CH ₂	C	87.1, 77.9	192
386	N-CH(CH ₃) ₂	CH ₂	C	87.3, 78.6	192
387	S	N-CH ₃	B	82.3, 81.0	194
388	S	N-CH(CH ₃) ₂	B		208
389	S	N-Tos	B	82.4, 79.0	194
390	S	N-Ph	B		195
391	S	N- <i>m</i> -tolyl	B		195
392	S	N- <i>p</i> -tolyl	B		195
393	S	N-3,4-dichlorophenyl	B		195
394	S	CH ₂	C	85.5, 79.9	191
395	S	C=C(CH ₃) ₂	D	85.2, 77.3	196
396	S	S	C	80.6	191, 197
397	Se	S	C	80.4, 80.7	191
398	Se	Se	E	80.6	191
399	Si(CH ₃) ₂	CH ₂	F	80.3, 79.1	142, 149
400	Si(CH ₃) ₂	C=C(CH ₃) ₂	D	79.9, 78.6	198, 199
401	Si(CH ₃) ₂	Si(CH ₃) ₂	F	76.2	142
402	Ge(CH ₃) ₂	CH ₂	F	79.6, 79.4	142
403	Ge(CH ₃) ₂	Ge(CH ₃) ₂	F	77.3	142
404	(1,8-naphtho)	O	D	($\nu=2235\text{ cm}^{-1}$)	200
405	(1,8-naphtho)	N-CH ₃	B		200

Cyclodecadiyne and its 1,6-dihetero derivatives **374**, **376–382**, **387** and **389** have been analyzed by X-ray diffraction, NMR and PES. These diynes adopt chair-like conformations with the slightly bent triple bonds arranged parallel to each other, the deviations of the acetylenic bond angles being in the range of 5°–10°. ¹³C-NMR shifts vary between 79 and 84 ppm. The chemical shift of the *sp* carbons in **412** ($\delta=93.6$ ppm) (Scheme 68) is comparable to the shifts found for the related **244** ($\delta=90.7$ ppm) and twelve-membered **245** ($\delta=92.0$ ppm) (Scheme 37). The relatively large distances of 2.9–3.1 Å between the triple bonds in these 1,6-diynes are responsible for the small splitting between the π^+ and π^- orbitals as shown by photoelectron spectroscopy. A study of the conformations of diazadiynes **377–382**, combining X-ray scattering, NMR-spectroscopy and theoretical methods showed that these compounds adopt chair-conformations with

the *N*-substituents in axial positions. In solution, equilibrium between chair- and boat-conformation is established; the latter is a local minimum, as stable as the chair. Furthermore, these studies led to a generalized anomeric effect.²⁰¹

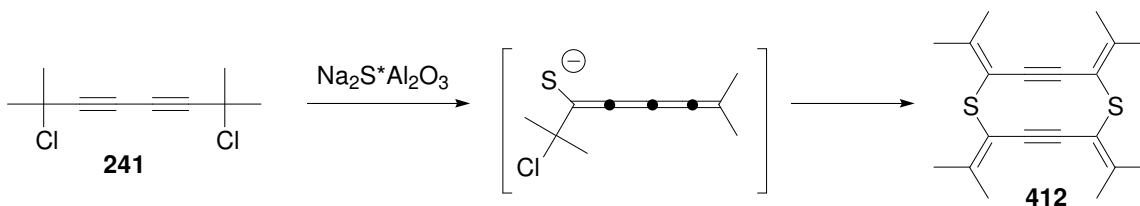

Scheme 68. S_N' -reactions to expanded dithiaradialene **384**.

Though the synthesis of aza-diyne **377** with free NH groups was possible by dealkylation of *N*-isopropyl derivative **380** with α -chloroethylchloroformate,¹⁹² all attempts to remove the tosyl group from compound **389** failed due to formation of bicyclo[4.4.0] scaffolds (Scheme 69).¹⁹⁴ These transannular reactions have also been studied theoretically.²⁰²

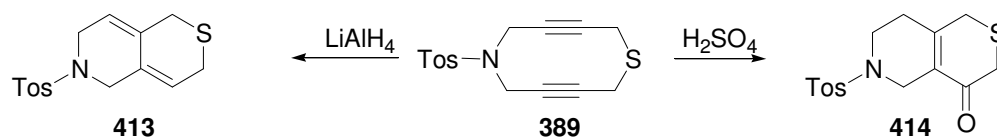

Scheme 69. Attempts to detosylation resulting in transannular cyclizations.

Similar polar transannular cyclizations occur in **380** and have been studied thoroughly by kinetic measurements and theoretically.²⁰³ Addition of HCl or methanol occurs selectively at the 3,8-positions with transannular cyclization to yield the bicyclo[4.4.0]decadiene **415** (Scheme 70). Only in concentrated sulfuric acid, a product **417** with the isomeric bicyclo[5.3.0]decene scaffold was also formed, **416** being the main product.

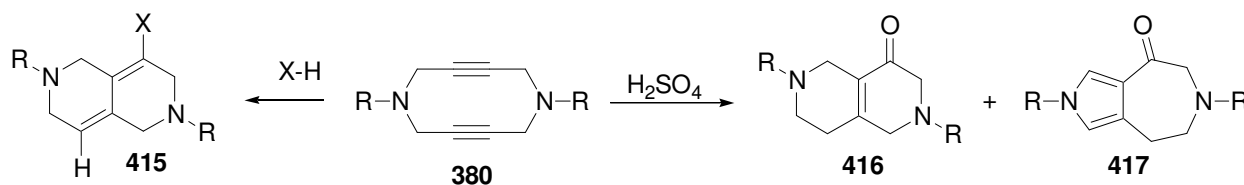

Scheme 70. Polar additions to diazadiene **380** ($R=i$ -propyl, $X=Cl, OCH_3$).

With the discovery of the enediyne antibiotics, medium-sized systems with the ability to undergo a Bergman-cyclization have gained great interest by chemists. A transannular distance of less than 3 Å between the termini of the enediyne moiety should result in a spontaneous cyclization.²⁰⁴ As the transannular distances in several cyclodecadiynes are in this range, reactions between both triple bonds appear to be possible. Heating diazadiyne **380** in the presence of a hydrogen donor like 1,4-cyclohexadiene results in the formation of biradical **418** (Scheme 71). Transfer of a hydrogen from cyclohexadiene and a second H-transfer or radical recombination gives butadienes **419** and **420** in a nearly quantitative yield.²⁰⁵

Heating diazadiynes such as **380** in methanol with catalytic amounts of Pd/C results in a completely different reaction (Scheme 72). 3,3'-Bis-pyrroles and their partially hydrogenated congeners are formed in almost quantitative yield. The isomerization/dehydrogenation occur probably *via* complexation of the palladium at the triple bonds and one nitrogen atom followed by transformation of the two acetylenes to a

palladacyclopentadiene, ring contraction to a Pd-cyclobutadiene complex and ring enlargement to a new pallada-cyclopentadiene. H-shift and reductive elimination complete the reorganization to give the (partially hydrogenated) bis-pyrroles.²⁰³

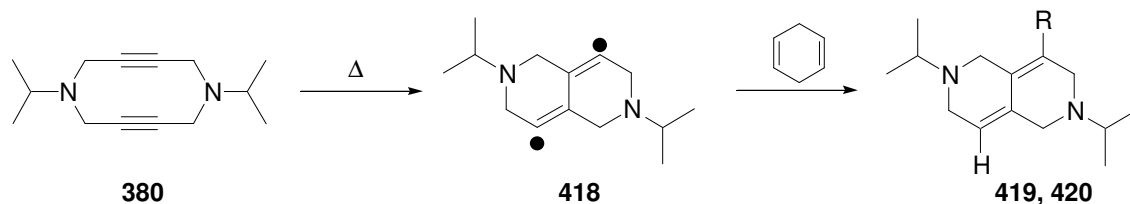

Scheme 71. Thermal transannular ring closure *via* 1,4-diradical (**419**: R=H; **420**: R=cyclohexadienyl).

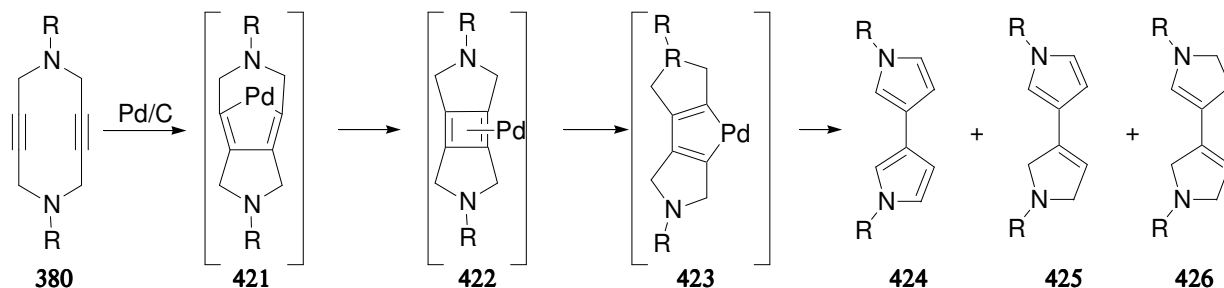

Scheme 72. Pd-catalyzed reorganization of diazacyclodecadiyne **380** (R=*i*-propyl).

Diyne like **380**, **386**, **388**, **394** and **396**, react with $\text{Co}_2(\text{CO})_8$ to give bis(hexacarbonyldicobalt) complexes **427** in moderate to high yields (47–94%) (Scheme 73).²⁰⁶ On the other hand, the bis-dicobalthexacarbonyl complex of **374** has been obtained by HBF_4 -catalyzed cyclodimerization of Co-complexed butynediol **55**.²⁰⁷ $\text{CpCo}(\text{CO})_2$ reacts with thiacyclodecadiynes **394** and **396** to diyne-cobalt complexes **428** that add a second molecule of the diyne to form annulated thiophenophanes^{205,208,209} **429** and superphanes²¹⁰ (*cf.* Scheme 52).

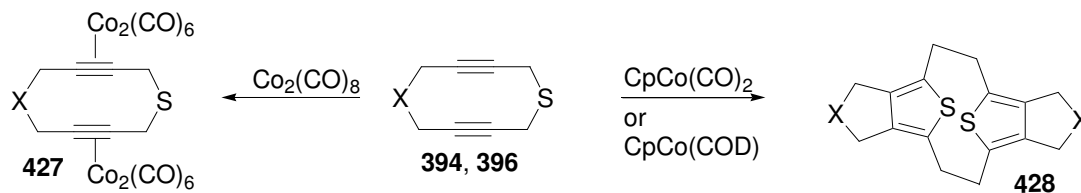

Scheme 73. Reactions of thiadecadiynes with cobaltcarbonyl complexes.

As part of an early project concerning electronic interactions of parallel triple bonds, 1,8-naphtho-annulated oxa- and azacyclodecadiyne **404** and **405** had been studied by Staab.²⁰⁰ Diyne **404** was prepared in low yields (17.5%) from deprotonated 1,8-diethynynaphthalene and bis(chloromethyl) ether **373** (route D, Scheme 67, Table 5) while the more sensitive azadiyne **405** was prepared *via* the diol **407**, the dibromide **408** followed by cyclization with methyl amine (4.5% yield in the final cyclization step). Catalyzed by platinum, **404** adds 1,2-bis(dimethylsilyl)benzene to give the polycyclic bisadduct **429** in 18% yield (Scheme 74).²¹¹ Applying the cycloalkylation strategy (A, Scheme 67) to α,ω -dibromides and **377** combined with high dilution conditions, Gleiter succeeded in the synthesis of several bi- and polycyclic compounds with one to three 1,6-diazacyclodeca-3,8-diyne subunits. As a part of this study, the reaction of diazadiyne **377** with **222** led to the bicyclic π -cage **430** in 10% yield (^{13}C -NMR: $\delta=86.6$ ppm) (Scheme 75).²¹²

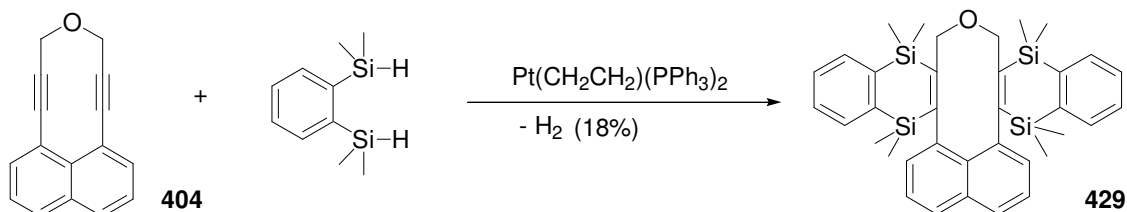

Scheme 74. Pt-catalyzed addition of a bis-silane to diyne **404**.

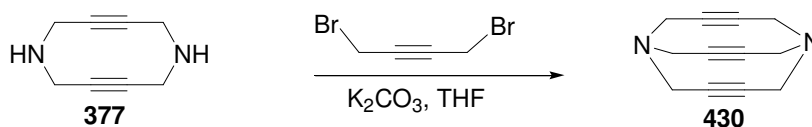

Scheme 75. Synthesis of π -cage **430**.

7.5. Sila- and germacyclodecyne

Three strategies for the synthesis of sila- and germacyclodecyne have found broad application: the coupling of deprotonated alkynes with chlorosilanes or chlorogermanes (*cf.* Schemes 52–54) and the reductive coupling of bis-(propargyl halides) (*cr.* Scheme 38), occasionally as reductive cross-coupling. Ring contraction provides another successful access to silacycloalkynes as shown in Schemes 21–23.

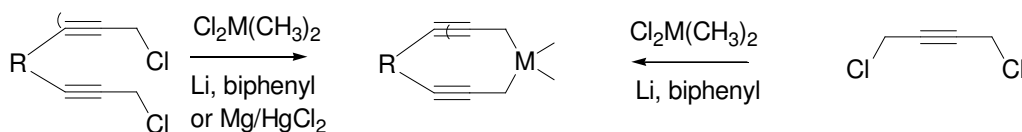

	M	R	yield	¹³ C-NMR (ppm)		M	R	Yiel d	¹³ C-NMR (ppm)
254	Si	-(CH ₂) ₂ -	15%	86.6, 81.4	435	Si	-Si(CH ₃) ₂ -CH ₂ - Si(CH ₃) ₂ -	32%	105.7, 84.3
310	Si	-Si(CH ₃) ₂ - Si(CH ₃) ₂ -	17%	109.9, 84.2	436	Si	-Si(CH ₃) ₂ -(CH ₂) ₂ - Si(CH ₃) ₂ -	18%	103.7, 83.3
399	Si	-(CH ₂) ₃ -	13%	80.3, 79.1	402	Ge	-(CH ₂) ₃ -	10%	79.6, 79.4
431	Si	-(CH ₂) ₄ -	16%	79.9, 77.1	437	Ge	-(CH ₂) ₄ -	22%	79.7, 78.1
432	Si	-(CH ₂) ₅ -	12%	78.3, 77.9	438	Ge	-(CH ₂) ₅ -	10%	78.9, 78.4
433	Si	-CH ₂ -Si(CH ₃) ₂ - CH ₂ -	20%		403	Ge	-(CH ₂)-Ge(CH ₃) ₂ - (CH ₂)-	17%	77.3
434	Si-Si	-Si(CH ₃) ₂ - Si(CH ₃) ₂ -	27%	108.2, 81.8					

1,1,2,2-Tetramethyl-1,2-disilacyclodeca-3,8-diyne **255** and its 1,4-disila isomer **253** have been prepared by reductive coupling of silane-connected bis(propargyl bromide)s in 10% and 20% yield (Scheme 38).¹⁴² **255** was obtained in 10% yield in a cyclization of dichlorodisilane and dichlorobutylene.²¹³ This reductive cross-coupling of linear bis-propargyl chlorides in the presence of dimethyldichlorosilane proved to be a suitable route to silacyclodiynes of large and medium ring size.^{142,212}

Applying the successful reductive cross-coupling strategy to dichlorobutylene in the presence of methyl- or phenyltrichlorosilane led to the π -cages **439** and **440**, though in poor yield (0.5%) (**439**: R=CH₃, ¹³C-NMR: δ =76.8 ppm; **440**: R=Ph, ¹³C-NMR: δ =76.9 ppm) (Figure 3). Isomers with a bicyclo[4.4.2]-tetradecadiyne **262** or bicyclo[4.2.2]dodecyne framework **263**, **264** and one or two exocyclic allene units have been formed as by-products *via* S_N2' mechanism.¹⁴⁹

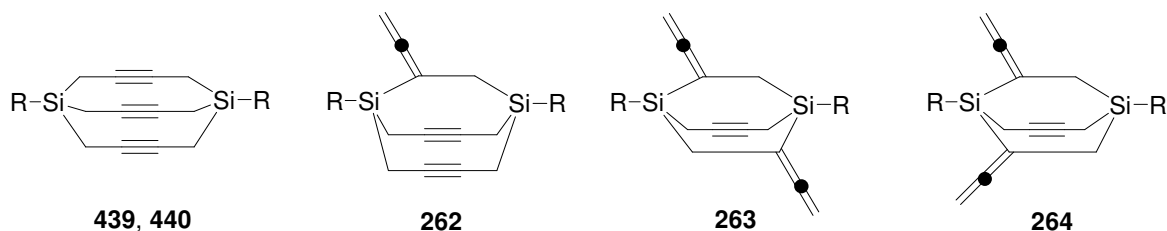
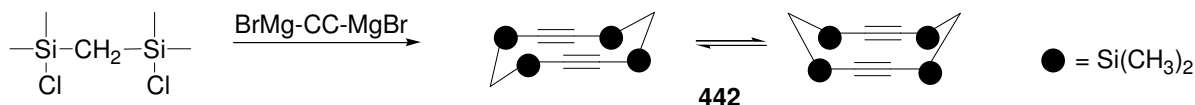

Figure 3. π -Cages **439** (R=CH₃), **440** (R=Ph) with silicon bridgeheads and ring-contracted isomers.

The structures of several sila-cycloalkynes, *e.g.* **253**, **254**, **310**, **399** and **431** have been studied by X-ray diffraction.^{142,149} A comparison of the solid-state structures of 1,1,2,2,3,3-hexamethyl-1,2,3-trisilacyclodeca-4,9-diyne **441**, **400** and π -cage **439** revealed chair conformations for the monocyclic compounds. As expected, the ten-membered rings in **439** adopt boat-conformations but the molecule is twisted around the Si-Si axis¹⁹⁸ with torsion along the triple bond axis of 29°. PES spectra reveal a strong splitting of the first and fourth band for the ten-membered rings (**399**, **402**, **403**, **433** and **435**) due to strong interaction between the in-plane linear π -combinations of the triple bonds and the bridges.^{142,212}

1,3,6,8-Tetrasilacyclodeca-4,9-diyne **442** has been obtained in 15% yield from the condensation of 2,4-dichloro-2,4-dimethyl-2,4-disilapentane and the di-Grignard reagent of acetylene (Scheme 77).¹⁴⁶ The chemical shift of the *sp* carbons is $\delta=115.0$ ppm, about 4.5 ppm upfield from the signal of tetrasilaoctadiyne **141** and nearly identical to similar compounds with larger ring sizes ($\delta=113.5$ –114 ppm). In the solid state, **442** adopts chair- and boat-like conformations, bond lengths of the triple bonds are 1.16 Å and bond angles at the acetylene are in the range of 175.8°–178.3°.²¹⁴



Scheme 77. Chair- and boat-conformation of tetrasiladiyne **442**.

The closely related dioxo-derivative **443** was isolated as a byproduct in the hydrolysis of 2,5-dichloro-2,5-dimethyl-2,5-disilahex-3-yne (Scheme 78). Only chair conformers were found in crystalline **443**, with an alkyne bond length of 1.215 Å and bond angle of 175.1°.²¹⁵ This alkyne has also been prepared by hydrolysis of the dicobalt-hexacarbonyl complex of the dichlorodisilahexyne **444** to form the bis(dicobalt-hexacarbonyl) complex of **443** in 28% yield. Free **443** was obtained by oxidation of the organometallic species with Ce(IV) (57%) ($\delta_{C\equiv C}=112.9$ ppm).²¹⁶ With Fe₂(CO)₉, a transannular reaction occurs in **443** to form a siloxane-bridged trimethylenemethane as its diironhexacarbonyl complex.²¹⁷

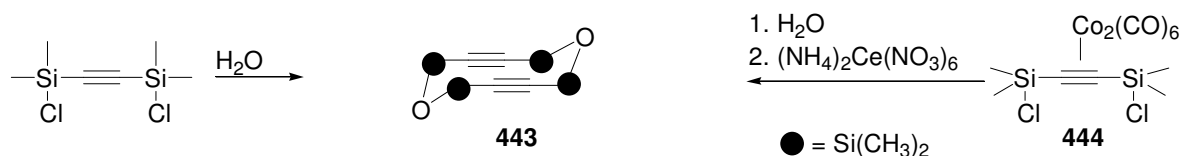

Scheme 78. Dioxatetrasilacyclodecadiyne **443**.

Benzo-annulated 1,4-disilacyclodeca-5,8-diyne have been investigated as substrates for transannular reductive cyclizations.²¹⁸ Starting from 1,2-bis(trimethylsilylethynyl)benzene, desilylation/lithiation with *n*-BuLi and treatment with the appropriate bis(chlorosilanes) gave the diynes **446** (R=-CH₂CH₂-) and **447**

(R=*o*-C₆H₄) (Scheme 79). Reduction of **446** with lithium naphthalene resulted in a transannular cyclization and the resulting dilithio compounds **448** and **449** were trapped with D₂O, ClSiH(CH₃)₂, or isopropoxy-dioxaborolane. Compared to non-cyclic diethynylbenzenes, the ethylene and phenylene tether reduce the interacetylenic distances thus facilitating the anionic cyclization. An X-ray analysis of **446** shows a length of the triple bond of 1.210 Å and bond angles of 169.1° and 172.6°. This distortion reduced the distance of the terminal acetylenic atoms to only 3.63 Å.

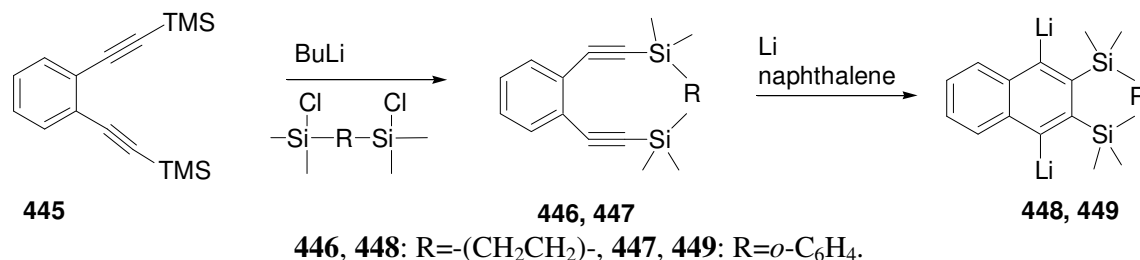

Scheme 79. Synthesis and anionic cyclization of benzoannulated disiladiynes.

As part of a morphine synthesis *via* a radical cyclization approach, Hudlicky studied a series of disilacyclodecadiynes (Scheme 80).²¹⁹ Bis-ynal **450** was reductively coupled to give the cyclic diyne **451** ($\delta_{C\equiv C}$ =104.5, 93.6 ppm) that was alkylated to monoether **452** ($\tilde{\nu}$ =2160 cm⁻¹, $\delta_{C\equiv C}$ =103.5, 102.1, 94.3, 92.8 ppm) from which the enediyne **453** ($\tilde{\nu}$ =2120 cm⁻¹, $\delta_{C\equiv C}$ =101.2, 98.8, 95.2, 84.1 ppm) was formed by elimination of water. This latter compound, upon thermal treatment in the presence of cyclohexadiene, did not give the anticipated Bergman rearrangement but a Claisen rearrangement instead and the ketone **454** ($\tilde{\nu}_{C=O}$ =2100 cm⁻¹, $\delta_{C\equiv C}$ =106.7, 104.0, 100.1, 91.7 ppm) was obtained in 43% yield. A second sequence, starting from the bis-ynal **450** and leading to the enediyne **459** lacking the allyloxy group, involves a nucleophilic cyclization with Na₂S to the eleven-membered heteradiyne **456** ($\delta_{C\equiv C}$ =101.1, 87.4 ppm), its oxidation to the sulfoxide **457** ($\tilde{\nu}_{C=O}$ =2170 cm⁻¹, $\delta_{C\equiv C}$ =101.1, 87.4 ppm) and thereafter a transformation to the chlorosulfone **458** ($\tilde{\nu}_{C=O}$ =2190 cm⁻¹, $\delta_{C\equiv C}$ =99.8, 94.4 ppm). A Ramberg-Backlund reaction afforded the enediyne **459** ($\tilde{\nu}_{C=O}$ =2110 cm⁻¹, $\delta_{C\equiv C}$ =103.0, 100.2). No Bergman cyclization was observed at temperatures below 225 °C.

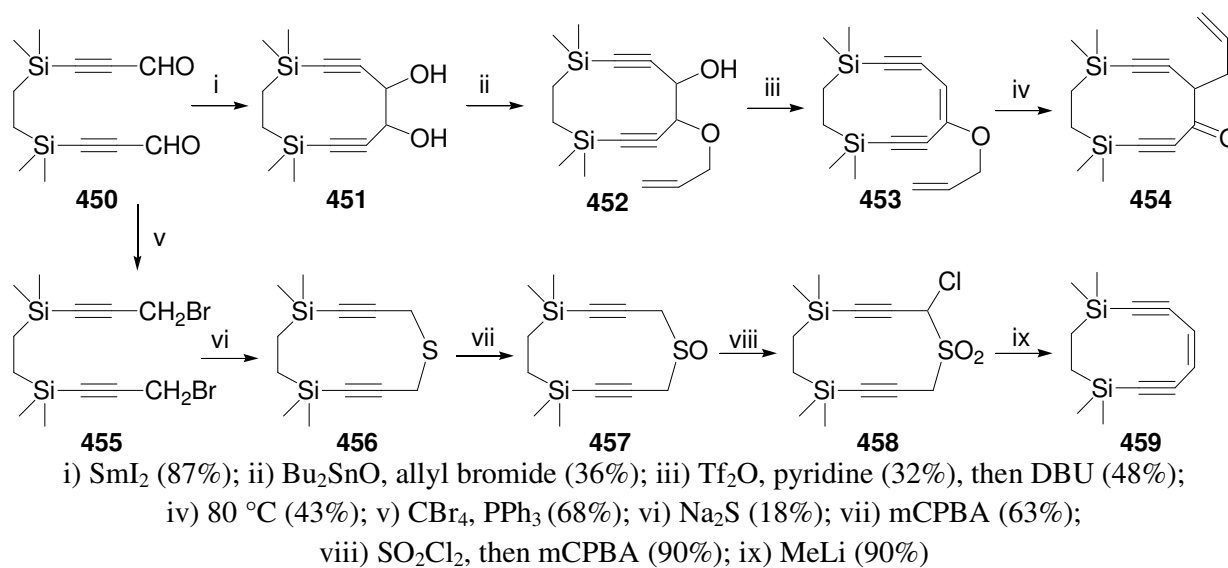

Scheme 80. Synthesis of 1,4-disilacyclodec-7-ene-5,9-diyne.

Octamethyl-1,2,5,8-tetrasilacyclodeca-3,6,9-triynes **327** has been observed¹⁷³ as product in the thermal ring contraction of the 12-membered triyne **325**. At 540 °C, a double extrusion of dimethylsilylene gives **327** in 27% yield (m.p. 106–108 °C), further thermal treatment resulted in a third elimination of dimethylsilylene to give trisilapericyclyne **328** (Scheme 55). Selective oxidation of the two hexamethyltrisilanylene units of 1,2,3,6,7,8-hexasilacyclodeca-4,9-diyne **460** with trimethylamine *N*-oxide (Scheme 81) gave a 14-membered tetraoxahexasiladiyne **461** in almost quantitative yield.²²⁰

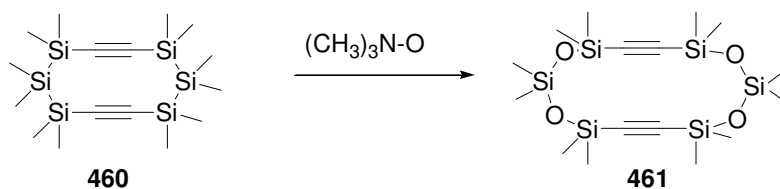

Scheme 81. Oxidative ring enlargement of hexasiladiyne **460**.

Octamethyl-1,2,5,8-tetrasilacyclodecyne **464** and the tetragerma derivative **465** have been obtained by cyclocondensation of dilithioacetylene and the 1,8-dichloro substituted silicon **462** or germanium compounds **463** in 62% and 23% yield (Scheme 82).²²¹ The resonances of the *sp* carbons appear at $\delta=116.0$ ppm (**464**) and 114.1 ppm (**465**). The presence of a catalytic system of palladium acetate and an isonitrile under 5000 bar pressure initiates a unique transannular addition of the 1,2-dimetalla unit to the triple bond to form tetrametalla-bicyclopentylidenes **466** and **467**.

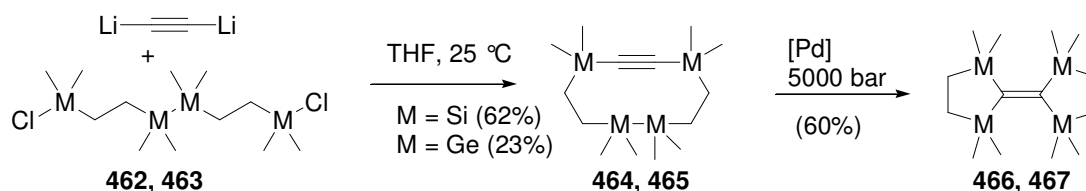

Scheme 82. Synthesis and isomerization of tetrasila- and tetragemacyclodecyne.

Bis-dicobalthexacarbonyl complexes of medium-sized diynes have been prepared from 1,1,3,3,6,6,8,8,-octamethyl-1,3,6,8-tetrasilacyclodecadiyne **442** (85%) as well as from several heterocyclic diynes of larger ring size. According to X-ray diffraction, the tethers between the cobalt-acetylene units adopt zig-zag conformations in the crystalline complexes. Furthermore, cobalt-heteroatom interactions have been found which are thought to play an important role in Pauson-Khand reactions.¹⁶⁷ 1,1,2,2,3,3-Hexamethyl-1,2,3-trisilacyclodeca-4,9-diyne **441** had been prepared like its nine-ring congener **295** from the di-Grignard reagent of heptadiyne and the corresponding 1,3-dichlorodisilane (7%, ¹³C-NMR: $\delta=109.8$, 85.0 ppm).²²² Like its higher homologues, this diyne reacts with CpCo(CO)₂ or CpCo(cod) to form sandwich-complexes with a bis-annulated cyclobutadiene ligand. With tetramethyl-1,4-disilacyclodeca-5,9-diyne **253**¹⁶⁷ as well as with larger disiladiynes, this reaction afforded even cyclobutadiene-superphanes (as their CoCp-complexes, *cf.* Scheme 52).²²³

8. Conclusion

Heteroatoms as ring atoms in cycloalkynes have strong influence on chemical and physical properties. Enhancement of strain occurs with oxygen or nitrogen whereas sulfur and, most prominent, silicon lead to less strained rings. Furthermore, the heteroatom polarizes the alkyne: strained alkynyl ethers or ynamines are

nearly unknown. Similar to the isocyclic systems, strained heterocycloalkynes are substrates for a large variety of addition reactions of different types, polar, radical and electrocyclic. The heteroatom can play a decisive role, interaction of lone pairs on sulfur or nitrogen atoms with cationic sites or the central atom of organometallic intermediates are often the rationale for unexpected transformations. A broad range of unprecedented organic and organometallic compounds, polycyclic arenes, cyclophanes and cage compounds has been obtained from these systems. During the past century, the chemistry of heterocycloalkynes has made a momentous shift from proposed intermediates and chemical curiosities to targets for structure-property relationships in spectroscopy and most recently to life science. Bergman- and Hopf-cyclizations can cleave DNA and the copper-free, strain-accelerated alkyne-azide addition is used for bioconjugation. This mode of labeling of biomolecules has become an important tool in biology and experimental medicine and is used for surface modifications in materials science.

References

1. Ruzicka, L.; Hürbin, M.; Boekenoogen, H. A. *Helv. Chim. Acta* **1933**, *16*, 498–505.
2. Blomquist, A. T.; Liu, L. H. *J. Am. Chem. Soc.* **1953**, *75*, 2153–2155.
3. Lespieau, R. *Compt. Rend.* **1929**, *188*, 502.
4. Meier, H. *Synthesis* **1972**, 235–253.
5. Krebs, A. *Cyclic Acetylenes In Chemistry of Acetylenes*; Viehe, H. G., Ed.; Marcel Dekker: New York, 1969.
6. Hoffmann, R. W. *Dehydrobenzene and Cycloalkynes*; Verlag Chemie: Weinheim, 1967.
7. Krebs, A.; Wilke, J. *Top. Curr. Chem.* **1984**, *109*, 189–233.
8. Nakagawa, M. *Cyclic Acetylenes In The Chemistry of the Carbon-Carbon Triple Bond*; Patai, S., Ed.; J. Wiley & Sons: New York, 1978.
9. Meier, H. *Cyclic Alkynes, Enynes and Dienynes In Advances in Strain in Organic Chemistry*; Halton, B., Ed.; JAI Press, 1991.
10. Hopf, H.; Grunenberg, J. *Angle-strained Cycloalkynes In Strained Hydrocarbons*; Dodziuk, H., Ed.; 2009; pp. 375–397.
11. Gleiter, R.; Werz, D. B. *Product Class 9: Cycloalkynes In Science of Synthesis* **2008**, *43*, 631–668.
12. Rademacher, P. *Strukturen Organischer Moleküle*; VCH: Weinheim, 1987.
13. Stoermer, R.; Kahlert, B. *Ber. Dtsch. Chem. Ges.* **1902**, *35*, 1633–1640.
14. Wittig, G. *Angew. Chem.* **1962**, *74*, 479–483.
15. Wittig, G.; Wahl, V. *Angew. Chem.* **1961**, *73*, 492.
16. Reinecke, M.; Newsom, J. G. *J. Am. Chem. Soc.* **1976**, *98*, 3021–3022.
17. Bolster, J. M.; Kellogg, R. M. *J. Am. Chem. Soc.* **1981**, *103*, 2868–2869.
18. Wentrup, C.; Blanch, R.; Briehl, H.; Gross, G. *J. Am. Chem. Soc.* **1988**, *110*, 1880–1883.
19. Olivella, S.; Pericàs, M. A.; Riera, A.; Serratos, S.; Solé, A. *J. Am. Chem. Soc.* **1987**, *109*, 5600–5605.
20. Ando, W.; Hojo, F.; Sekigawa, S.; Nakayama, N.; Shimizu, T. *Organometallics* **1992**, *11*, 1009–1011.
21. Pang, Y.; Schneider, A.; Barton, T. J. *J. Am. Chem. Soc.* **1992**, *114*, 4920–4921.
22. Wittig, G.; Krebs, A. *Chem. Ber.* **1961**, *94*, 3260–3275.
23. Alder, K.; Stein, G.; Finzenhagen, H. *Liebigs Ann. Chem.* **1931**, *485*, 211–222.
24. Alder, K.; Stein, G. *Liebigs Ann. Chem.* **1933**, *501*, 1–48.
25. Ziegler, K.; Wilms, H. *Liebigs Ann. Chem.* **1950**, *567*, 1–43.
26. Krebs, A.; Burgdörfer, G. *Tetrahedron Lett.* **1973**, *23*, 2063–2064.
27. Tochtermann, W.; Oppenländer, K.; Hoang, M. N.-D. *Liebigs Ann. Chem.* **1967**, *701*, 117–125.
28. Klosin, J.; Abboud, K. A.; Jones, W. M. *Organometallics* **1995**, *14*, 2892–2902.
29. Axtell, H. C.; Howell, W. M.; Schmid, L. G.; Cann, M. C. *J. Org. Chem.* **1990**, *56*, 3906–3908.
30. Bennett, R. A.; Cann, M. C. *J. Heterocycl. Chem.* **1994**, *31*, 293–296.

31. Najdi, S. D.; Olmstead, M. M.; Schore, N. E. *J. Organomet. Chem.* **1992**, *431*, 335–358.
32. Brook, M. A.; Urschey, J.; Stradiotto, M. *Organometallics* **1998**, *17*, 5342–5346.
33. Hosokawa, S.; Isobe, M. *Tetrahedron Lett.* **1998**, *39*, 2609–2612.
34. Murata, M.; Legrand, A. M.; Ishibashi, Y.; Fukui, M.; Yasumoto, T. *J. Am. Chem. Soc.* **1990**, *112*, 4380–4386.
35. Díaz, D. D.; Ramírez, M. A.; Martín, V. S. *Chem. Eur. J.* **2006**, *12*, 2593–2606.
36. Krebs, A.; Kimling, H. *Tetrahedron Lett.* **1970**, *10*, 761–764.
37. Krebs, A.; Kimling, H. *Liebigs Ann. Chem.* **1974**, 2074–2084.
38. Su, M.-D. *J. Chin. Chem. Soc.* **2005**, *52*, 599–624.
39. Turro, N. J.; Ramamurthy, V.; Liu, K. C.; Krebs, A.; Kemper, R. *J. Am. Chem. Soc.* **1976**, *98*, 6758–6761.
40. Turro, N. J.; Chow, M.-F.; Kanfer, S.; Jacobs, M. *Tetrahedron Lett.* **1981**, *22*, 3–6.
41. Krebs, A.; Kimling, H. *Angew. Chem. Int. Ed.* **1971**, *10*, 409–410.
42. Krebs, A.; Berndt, J. *Tetrahedron Lett.* **1983**, *24*, 4083–4086.
43. Egorov, M. P.; Ezhova, M. B.; Kolesnikov, S. P.; Nefedov, O. M.; Taraban, M. B.; Kruppa, A. I.; Leshina, T. V. *Mendeleev Commun.* **1991**, *1*, 143–145.
44. Egorov, M. P.; Kolesinoy, Yu. S. P. *J. Organomet. Chem.* **1985**, *290*, C27.
45. Suzuki, H.; Tokitoh, N.; Okazaki, R. *Bull. Chem. Soc. Jpn.* **1995**, *68*, 2471–2482.
46. Kolesnikov, S. P.; Egorov, M. P.; Galminas, A. M.; Struchkov, Yu. T.; Krebs, A.; Nefedov, O. M. *Izv. Akad. Nauk SSSR, Ser. Khim.* **1987**, *8*, 1835–1840.
47. Nefedov, O. M.; Kolesnikov, S. P.; Egorov, M. P.; Galminas, M.; Krebs, A. *Izv. Akad. Nauk SSSR, Ser. Khim.* **1985**, *12*, 2834; *Russ. Chem. Bull.* **1985**, *34*, 2634.
48. Kolesnikov, S. P.; Egorov, M. P.; Galminas, A.; Krebs, A.; Nefedov, O. M. *Izv. Akad. Nauk SSSR, Ser. Khim.* **1985**, *12*, 2832; *Russ. Chem. Bull.* **1985**, *34*, 2631.
49. Kolesnikov, S. P.; Krebs, A.; Nefedov, O. M. *Izv. Akad. Nauk SSSR, Ser. Khim.* **1983**, *9*, 2173–2374.
50. Sita, L. R.; Bickerstaff, R. D. *J. Am. Chem. Soc.* **1988**, *110*, 5208–5209.
51. Gerres, T.; Heesing, A. *Chem. Ber.* **1992**, *125*, 1439–1447.
52. Krebs, A.; Colberg, H. *Chem. Ber.* **1980**, *113*, 2007–2014.
53. Schmidt, H.; Schweig, A.; Krebs, A. *Tetrahedron Lett.* **1974**, *16*, 1471–1474.
54. Haase, J.; Krebs, A. *Z. Naturforsch.* **1972**, *27a*, 624–627.
55. Haase, J.; Krebs, A. *Z. Naturforsch.* **1971**, *26a*, 1190–1193.
56. Kimling, H.; Krebs, A. *Angew. Chem.* **1972**, *84*, 952–953; *Angew. Chem. Int. Ed.* **1972**, *11*, 932–933.
57. Krebs, A.; Kimling, H.; Kemper, R. *Liebigs Ann. Chem.* **1978**, 431–439.
58. Olbrich, F.; Kopf, J.; Weiss, E. *Acta Cryst.* **1990**, *C46*, 1650–1652.
59. Olbrich, F.; Schmidt, G.; Behrens, U.; Weiss, E. *J. Organomet. Chem.* **1991**, *418*, 421–429.
60. Olbrich, F.; Kopf, J.; Weiss, E. *J. Organomet. Chem.* **1993**, *456*, 293–298.
61. Olbrich, F.; Behrens, U.; Groger, G.; Weiss, E. *J. Organomet. Chem.* **1993**, *448*, C10–C12.
62. Olbrich, F.; Behrens, U.; Schmidt, G.; Weiss, E. *J. Organomet. Chem.* **1993**, *463*, 249–254.
63. Olbrich, F.; Behrens, U.; Weiss, E. *J. Organomet. Chem.* **1993**, *472*, 365–370.
64. Olbrich, F.; Schmidt, G.; Weiss, E.; Behrens, U. *J. Organomet. Chem.* **1993**, *463*, 299–303.
65. Brussaard, Y.; Olbrich, F.; Behrens, U. *J. Organomet. Chem.* **1996**, *519*, 115–123.
66. Schmidt, G.; Behrens, U. *J. Organomet. Chem.* **1996**, *509*, 49–55.
67. Schulte, P.; Gröger, G.; Behrens, U. *J. Organomet. Chem.* **1999**, *584*, 1–10.
68. Gröger, G.; Olbrich, F.; Weiss, E.; Behrens, U. *J. Organomet. Chem.* **1996**, *514*, 81–86.
69. Schulte, P.; Behrens, U. *J. Organomet. Chem.* **1998**, *563*, 235–249.
70. Gröger, G.; Olbrich, F.; Schulte, P.; Behrens, U. *J. Organomet. Chem.* **1998**, *557*, 251–258.
71. Gröger, G.; Behrens, U.; Olbrich, F. *Organometallics* **2000**, *19*, 3354–3360.
72. Schulte, P.; Behrens, U.; Olbrich, F. *Z. Anorg. Allgem. Chem.* **2000**, *626*, 1692–1696.
73. Detert, H.; Meier, H. *Liebigs Ann. Chem./Recueil* **1997**, 1565–1570.
74. Detert, H.; Rose, B.; Mayer, W.; Meier, H. *Chem. Ber.* **1994**, *127*, 1529–1532.
75. Schulte, P.; Behrens, U. *J. Organomet. Chem.* **1998**, *563*, 235–249.

76. Schulte, P.; Behrens, U. *Chem. Commun.* **1998**, 1633–1634.
77. Höpfner, U. Diploma thesis, University of Heidelberg, Heidelberg, 1976.
78. Höpfner, U. PhD thesis, University of Heidelberg, Heidelberg, 1979.
79. Puster, P. PhD thesis, University of Heidelberg, Heidelberg, 1976.
80. Bartsch, H. H.; Colberg, H.; Krebs, A. *Z. Kristallogr.* **1981**, *156*, 10–12.
81. Herges, R.; Papafilipopoulos, A.; Hess, K.; Lenoir, D.; Chiappe, C.; Detert, H. *Angew. Chem.* **2005**, *117*, 1437–1441; *Angew. Chem. Int. Ed.* **2005**, *44*, 1412–1416.
82. Hohlt, H.-J. PhD thesis, University of Hamburg, Hamburg, 1981.
83. Lorch, M.; Meier, H. *Chem. Ber.* **1981**, *114*, 2382–2391.
84. Müller, E.; Winter, W. *Liebigs Ann. Chem.* **1975**, 605–610.
85. Plater, M. J.; Rees, C. W.; Slawin, A. M. Z.; Williams, D. J. *J. Chem. Soc., Chem. Commun.* **1990**, 1315–1317.
86. Plater, M. J.; Rees, C. W. *J. Chem. Soc., Chem. Commun.* **1990**, 1317–1319.
87. Plater, M. J.; Rees, C. W. *J. Chem. Soc., Chem. Commun.* **1990**, 1319–1321.
88. Gilbert, T. M. *Organometallics* **2000**, *19*, 1160–1165.
89. Karaev, S. F.; Krebs, A. *Tetrahedron Lett.* **1973**, *30*, 2853–2854.
90. Schulte, P.; Schmidt, G.; Kramer, C. P.; Krebs, A.; Behrens, U. *J. Organomet. Chem.* **1997**, *530*, 95–100.
91. Petrich, S. A.; Pang, Y.; Young, V. G., Jr.; Barton, T. J. *J. Am. Chem. Soc.* **1993**, *115*, 1591–1593.
92. Ando, W.; Nakayama, N.; Kabe, Y.; Shimizu, T. *Tetrahedron Lett.* **1990**, *31*, 3597–3598.
93. Hojo, F.; Sekigawa, S.; Nakayama, N.; Shimizu, T.; Ando, W. *Organometallics* **1993**, *12*, 803–810.
94. Typke, V.; Haase, J.; Krebs, A. *J. Mol. Struct.* **1979**, *56*, 77–86.
95. Sekigawa, S.; Shimizu, T.; Ando, W. *Tetrahedron* **1993**, *49*, 6359–6366.
96. Cervantes-Lee, F.; Párkányi, L.; Kapoor, R. N.; Mayr, A. J.; Pannell, K. H.; Pang, Y.; Barton, T. J. *J. Organomet. Chem.* **1998**, *562*, 29–33.
97. Sakurai, H.; Nakadaira, Y.; Hosomi, A.; Eriyama, Y.; Kabuto, C. *J. Am. Chem. Soc.* **1983**, *105*, 3359–3360.
98. Meier, H.; Stavridou, E.; Roth, S.; Mayer, W. *Chem. Ber.* **1990**, *123*, 1411–1414.
99. Shin, J.-T.; Shin, S.; Cho, C.-G. *Tetrahedron Lett.* **2004**, *45*, 5857–5860.
100. Shin, J. T.; Hong, S. C.; Shin, S.; Cho, C.-G. *Org. Lett.* **2006**, *8*, 3339–3341.
101. Mayer, W. PhD thesis, Johannes Gutenberg-University, Mainz, Germany, **1989**.
102. Detert, H. PhD thesis, Johannes Gutenberg-University, Mainz, Germany, **1991**.
103. Agard, N. J.; Prescher, J. A.; Bertozzi, C. R. *J. Am. Chem. Soc.* **2004**, *126*, 15046–15047.
104. Jewett, J. C.; Bertozzi, C. R. *Chem. Soc. Rev.* **2010**, *39*, 1272–1279.
105. Dommerholt, J.; Schmidt, S.; Temming, R.; Hendriks, L. J. A.; Rutjes, F. P. J. T.; van Hest, J. C. M.; Lefeber, D. J.; Friedl, P.; van Delft, F. L. *Angew. Chem. Int. Ed.* **2010**, *49*, 9422–9425.
106. Chenoweth, K.; Chenoweth, D.; Goddard III, W. A. *Org. Biomol. Chem.* **2009**, *7*, 5255–5258.
107. Sletten, E. M.; Bertozzi, C. R. *Org. Lett.* **2008**, *10*, 3097–3099.
108. Jewett, J. C.; Sletten, E. M.; Bertozzi, C. R. *J. Am. Chem. Soc.* **2010**, *132*, 3688–3690.
109. Starke, F.; Walther, M.; Pietzsch, H.-J. *Arkivoc* **2010**, *xi*, 350–359.
110. Debets, M. F.; van Berkel, S. S.; Schoffelen, S.; Rutjes, F. P. J. T.; van Hest, J. C. M.; van Delft, F. L. *Chem. Commun.* **2010**, *46*, 97–99.
111. Kuzmin, A.; Poloukhine, A.; Wolfert, M. A.; Popik, V. V. *Bioconjugate Chem.* **2010**, *21*, 2076–2085.
112. Chan, T. R.; Hilgraf, R.; Sharpless, K. B.; Fokin, V. V. *Org. Lett.* **2004**, *6*, 2853–2855.
113. Canalle, L. A.; van Berkel, S. S.; de Haan, L. T.; van Hest, J. C. M. *Adv. Funct. Mater.* **2009**, *19*, 3464–3690.
114. Lutz, J.-F. *Angew. Chem.* **2008**, *118*, 2212–2214; *Angew. Chem. Int. Ed.* **2008**, *47*, 2182–2184.
115. Zheng, T.; Jiang, H. J.; Gros, M.; del Amo, D. S.; Sundaram, S.; Lauvau, G.; Marlow, F.; Liu, Y.; Stanley, P.; Wu, P. *Angew. Chem. Int. Ed.* **2011**, *50*, 4113–4117.
116. Canalle, L. A.; van der Knaap, M.; Overhand, M.; van Hest, J. C. M. *Macromol. Rapid Commun.* **2011**, *32*, 203–208.

117. Liße, D.; Wilkens, V.; You, C.; Busch, K.; Piehler, J. *Angew. Chem. Int. Ed.* **2011**, *50*, 9352–9355.
118. Jewett, J. C.; Bertozzi, C. R. *Org. Lett.* **2011**, *13*, 5937–5939.
119. Yao, J. Z.; Uttamapinant, C.; Poloukhine, A. A.; Baskin, J. M.; Codelli, J. A.; Sletten, E. M.; Bertozzi, C. R.; Popik, V. V.; Ting, A. Y. *J. Am. Chem. Soc.* **2012**, DOI 10.1021/ja208090p.
120. Cheng, Z.; Elias, D. W.; Kamat, N. P.; Johnston, E. D.; Poloukhine, A.; Popik, V.; Hammer, D. A.; Tsourkas, A. *Bioconjugate Chem.* **2011**, *22*, 2021–2029.
121. Xu, J.; Fillion, T. M.; Prifti, F.; Song, J. *Chem. Asian J.* **2011**, *6*, 2730–2737.
122. Xu, J.; Prifti, F.; Song, J. *Macromolecules* **2011**, *44*, 2660–2667.
123. Arumugam, S.; Chin, S.; Schirmacher, R.; Popik, V. V.; Kostikov, A. P. *Bioorg. Med. Chem. Lett.* **2011**, *21*, 6987–6991.
124. Bouvet, V.; Wuest, M.; Wuest, F. *Org. Biomol. Chem.* **2011**, *9*, 7393–7399.
125. Carpenter, R. D.; Hausner, S. H.; Sutcliffe, J. L. *Med. Chem. Lett.* **2011**, *2*, 885–889.
126. Sletten, E. M.; Bertozzi, C. R. *Acc. Chem. Res.* **2011**, *44*, 666–676.
127. Boyce, M.; Bertozzi, C. R. *Nature Methods* **2011**, *8*, 638–642.
128. Jewett, J. C.; Bertozzi, C. R. *Chem. Soc. Rev.* **2010**, *39*, 1272–1279.
129. Jewett, J. C.; Bertozzi, C. R.; Sletten, E. M.; Gordon, C. G. U.S. Pat. Appl. Publ. (2011) US 20110207147 A1 20110825.
130. Meier, H.; Stavridou, E.; Storek, C. *Angew. Chem.* **1986**, *98*, 838–839; *Angew. Chem. Int. Ed.* **1986**, *25*, 809–810.
131. Stavridou, E.; Schumacher, H.; Meier, H. *Liebigs Ann. Chem.* **1989**, 435–441.
132. Meier, H.; Dai, Y.; Schuhmacher, H.; Kolshorn, H. *Chem. Ber.* **1994**, *127*, 2035–2041.
133. Meier, H.; Dai, Y. *Tetrahedron Lett.* **1993**, *34*, 5277–5280.
134. Kerton, F. M.; Mohmand, G. F.; Tersteegen, A.; Thiel, M.; Went, M. J. *J. Organomet. Chem.* **1996**, *519*, 177–184.
135. Mohmand, G. F.; Thiele, K.; Went, M. J. *J. Organomet. Chem.* **1994**, *471*, 241–248.
136. Gelling, A.; Mohmand, G. F.; Jeffery, J. C.; Went, M. J. *J. Chem. Soc., Dalton Trans.* **1993**, 1857–1862.
137. Meier, H.; Petersen, H.; Kolshorn, H. *Chem. Ber.* **1980**, *113*, 2398–2409.
138. Ibis, C.; Gürün, C. *Phosphorus, Sulfur Silicon Relat. Elem.* **1993**, *83*, 119–123.
139. Gleiter, R.; Röckel, H.; Irgartinger, H.; Oeser, T. *Angew. Chem.* **1994**, *106*, 1340V1342; *Angew. Chem. Int. Ed.* **1994**, *33*, 1270–1272.
140. Gleiter, R.; Röckel, H.; Nuber, B. *Tetrahedron Lett.* **1995**, *36*, 1835–1838.
141. Haberauer, G.; Roers, R.; Gleiter, R. *Tetrahedron Lett.* **1997**, *38*, 8679–8687.
142. Gleiter, R.; Haberauer, G.; Irgartinger, H.; Oeser, T.; Rominger, F. *Organometallics* **1999**, *18*, 3615–3622.
143. Kloster-Jensen, E.; Wirz, J. *Helv. Chim. Acta* **1975**, *58*, 162–177.
144. Haberauer, G.; Rominger, F.; Gleiter, R. *J. Chem. Soc., Perkin Trans. 2* **1999**, 947–950.
145. Haberauer, G.; Rominger, F.; Gleiter, R. *Angew. Chem.* **1998**, *110*, 3632–3634; *Angew. Chem. Int. Ed.* **1998**, *37*, 3376–3377.
146. Kloster-Jensen, E.; Eliassen, G. A. *Angew. Chem.* **1985**, *97*, 587–588; *Angew. Chem. Int. Ed.* **1985**, *24*, 565–566.
147. Zhang, L.; Borysenko, C. W.; Albright, T. A.; Bittner, E. R.; Lee, T. R. *J. Org. Chem.* **2001**, *66*, 5276–5283.
148. Iwahara, T.; West, R. *Chem. Lett.* **1991**, 545–548.
149. Gleiter, R.; Stahr, H. *Tetrahedron Lett.* **1996**, *37*, 1179–1182.
150. Crisp, G. T.; Bubner, T. P. *Tetrahedron* **1997**, *53*, 11881–11898.
151. Betancort, J. M.; Martín, T.; Palazó, J. M.; Martín, V. S. *J. Org. Chem.* **2003**, *68*, 3216–3224.
152. Hamajima, A.; Nakata, H.; Goto, M.; Isobe, M. *Chem. Lett.* **2006**, *35*, 464–465.
153. Caine, D.; Arant, M. E. *Tetrahedron Lett.* **1994**, *35*, 6795–6798.
154. Detert, H.; Antony-Mayer, C.; Meier, H. *Angew. Chem.* **1992**, *104*, 755–757; *Angew. Chem. Int. Ed.* **1992**, *31*, 791–792.

155. Krämer, G.; Detert, H.; Meier, H. *Tetrahedron Lett.* **2009**, *50*, 4810–4812.
156. Schulte, M.; Schürmann, M.; Dakternieks, D.; Jurkschat, K. *Chem. Commun.* **1999**, 1291–1292.
157. Cohen, J. I.; Shteto, V.; Engel, R. *Synthesis* **2000**, 1263–1268.
158. Cohen, J. I.; Engel, R. *Synth. Commun.* **2000**, *30*, 2161–2164.
159. Lall, S.; Behaj, V.; Mancheno, D.; Casiano, R.; Thomas, M.; Rikin, A.; Gaillard, J.; Raju, R.; Scumpia, A.; Castro, S.; Engel, R.; Cohen, J. L. I. *Synthesis* **2002**, 1530–1540.
160. Mandal, S.; Basak, A. *Tetrahedron Lett.* **2009**, *50*, 3641–3644.
161. Hopf, H.; Musso, H. *Angew. Chem.* **1969**, *81*, 704; *Angew. Chem., Int. Ed. Engl.* **1969**, 680.
162. Hopf, H.; Krüger, A. *Chem. Eur. J.* **2001**, *7*, 4378–4385.
163. Zhang, X.; Zhang, Y.; Huang, J.; Hsung, R. P.; Kurtz, K. C. M.; Oppenheimer, J.; Petersen, M. E.; Sagamanova, I. K.; Shen, L.; Tracey, M. R. *J. Org. Chem.* **2006**, *71*, 4170–4177.
164. Kerton, F. M.; Mohmand, G. F.; Webb, J. D.; Went, M. J. *Polyhedron* **1997**, *16*, 1529–1524.
165. Adam, W.; Bosio, S. G.; Fröhling, B.; Leusser, D.; Stalke, D. *J. Am. Chem. Soc.* **2002**, *124*, 8316–8320.
166. Kuligowski, C.; Bezzenine-Lafollée, S.; Chaume, G.; Mahuteau, J.; Barrière, J. C.; Bacqué, E.; Pancrazi, A.; Ardisson, J. *J. Org. Chem.* **2002**, *67*, 4565–4568.
167. Schaller, R. J.; Haberhauer, G.; Gleiter, R.; Rominger, F. *Eur. J. Inorg. Chem.* **2002**, 2296–2304.
168. Trupia, S.; Classen, J.; Gleiter, R.; Geiger, W. E. *Inorg. Chim. Acta* **2011**, *374*, 88–93.
169. Werz, D. B.; Schulte, J. H.; Rausch, B. J.; Gleiter, R.; Rominger, F. *Eur. J. Inorg. Chem.* **2004**, 2585–2593.
170. Sakurai, H.; Yasuhiro, N.; Yunichi, E. JPN Kakai Tokkyo Koho 1983, JP 58152893 A 19830910.
171. Werz, D. B.; Gleiter, R. *Org. Lett.* **2004**, *6*, 589–592.
172. Boldyrev, A. I.; Zhdankin, V. V.; Simons, J.; Stang, P. J. *J. Am. Chem. Soc.* **1992**, *114*, 10569–10572.
173. Sakurai, H.; Eriyama, Y.; Hosomi, A. *Chem. Lett.* **1984**, 595–598.
174. Gleiter, R.; Stahr, H.; Stadtmüller, F.; Irngartinger, H.; Pritzkow, H. *Tetrahedron Lett.* **1995**, *36*, 4603–4606.
175. Scott, L. T.; Unno, M. *J. Am. Chem. Soc.* **1990**, *112*, 7823–7825.
176. Koch-Pomeranz, U.; Hansen, H.-J.; Schmid, H. *Helv. Chim. Acta* **1973**, *56*, 2981–3004.
177. Lustenberger, P.; Martinborough, E.; Denti, T. M.; Diederich, F. *J. Chem. Soc., Perkin Trans. 2* **1998**, 747–761.
178. Majahan, J. R.; Resck, I. S. *J. Chem. Soc., Chem. Commun.* **1993**, 1748–1749.
179. Majahan, J. R.; Resck, I. S. *Synth. Commun.* **1996**, *26*, 3809–3819.
180. Liang, L.; Ramaseshan, M.; MaGee, D. I. *Tetrahedron* **1993**, *49*, 2159–2168.
181. Inanaga, J.; Kawanami, Y.; Yamaguchi, M. *Bull. Chem. Soc. Jpn.* **1986**, *59*, 1521–1528.
182. Inanaga, J.; Katsuki, T.; Takimoto, S.; Ouchida, S.; Inoue, K.; Nakano, A.; Okukado, N.; Yamaguchi, M. *Chem. Lett.* **1979**, 1021–1024.
183. Canalle, L. A.; van Berkel, S. S.; de Haan, L. T.; van Hest, J. C. M. *Adv. Funct. Mater.* **2009**, *19*, 3464–3690.
184. Pirrung, F. O. H.; Hiemstra, H.; Speckamp, W. N. *Tetrahedron* **1994**, *50*, 12415–12442.
185. Wender, P. A.; Marmata, M.; Jeffrey, D.; Mukai, C.; Suffert, J. *Tetrahedron Lett.* **1988**, *29*, 909–912.
186. Sakai, Y.; Nishiwaki, E.; Shishido, K.; Shibuya, M.; Kido, M. *Tetrahedron Lett.* **1991**, *32*, 4363–4366.
187. Cram, D. J.; Allinger, N. L. *J. Am. Chem. Soc.* **1956**, *78*, 2518–2524.
188. Treibs, W.; Pester, R. *Tetrahedron Lett.* **1960**, *1*, 5–8.
189. Sondheimer, F.; Gaoni, Y.; Bregman, J. *Tetrahedron Lett.* **1960**, *1*, 25–29.
190. Gleiter, R. *Angew. Chem.* **1992**, *104*, 29–46; *Angew. Chem. Int. Ed.* **1992**, *31*, 27–43.
191. Gleiter, R.; Rittinger, S.; Langer, H. *Chem. Ber.* **1991**, *124*, 357–363.
192. Ritter, J.; Gleiter, R. *Liebigs Ann./Recueil* **1997**, 2113–2118.
193. Gleiter, R.; Ritter, J.; Irngartinger, H.; Lichtenthäler, J. *Tetrahedron Lett.* **1991**, *32*, 2887–2890.
194. Gleiter, R.; Ritter, J.; Irngartinger, H.; Lichtenthäler, J. *Tetrahedron Lett.* **1991**, *32*, 2883–2886.
195. Thyagarajan, B. S.; Traugott, T.; Takahashi, T. *J. Ind. Chem. Soc.* **1978**, *55*, 1228–1231.
196. Gleiter, R.; Merger, R.; Teptow, B.; Wittwer, W.; Pflästerer, G. *Synthesis* **1993**, 558–560.

197. Eglinton, G.; Lardy, I. A.; Raphael, R. A.; Sim, G. A. *J. Chem. Soc.* **1964**, 1154–1158.
198. Stahr, H.; Gleiter, R.; Haberauer, G.; Irngartinger, H.; Oeser, T. *Chem. Ber./Recueil* **1997**, *130*, 1807–1811.
199. Gleiter, R.; Stahr, H. *Tetrahedron Lett.* **1996**, *37*, 1179–1182.
200. Nissen, A.; Staab, H. A. *Chem. Ber.* **1971**, *104*, 1191–1198.
201. Ritter, J.; Gleiter, R.; Irngartinger, H.; Oeser, T. *J. Am. Chem. Soc.* **1997**, *119*, 10559–10607.
202. Haberauer, G.; Gleiter, R. *J. Am. Chem. Soc.* **1999**, *121*, 4664–4668.
203. Gleiter, R.; Ritter, J. *Tetrahedron* **1996**, *52*, 10383–10388.
204. Nicolaou, K. C.; Dai, W.-M. *Angew. Chem.* **1991**, *103*, 1453–1481; *Angew. Chem. Int. Ed.* **1991**, *30*, 1387–1416.
205. Gleiter, R.; Ritter, J. *Angew. Chem.* **1994**, *106*, 2550–2552; *Angew. Chem. Int. Ed.* **1994**, *33*, 2476–2478.
206. Rausch, B. J.; Gleiter, R.; Rominger, F. *J. Chem. Soc., Dalton Trans.* **2002**, 2219–2226.
207. Golovko, V. B.; Mays, M. J.; Solan, G. A. *Polyhedron* **2007**, *27*, 167–174.
208. Gleiter, R.; Classen, J.; Rausch, B. J.; Oeser, T.; Rominger, F. *J. Organomet. Chem.* **2002**, *641*, 3–8.
209. Gleiter, R.; Karcher, M.; Nuber, B.; Ziegler, M. L. *Angew. Chem.* **1987**, *99*, 805–806; *Angew. Chem. Int. Ed.* **1987**, *26*, 763–764.
210. Gleiter, R.; Kratz, D. *Acc. Chem. Res.* **1993**, *23*, 311–318.
211. Shimada, S.; Uchimar, Y.; Tanaka, M. *Chem. Lett.* **1995**, 223–224.
212. Gleiter, R.; Hövermann, K.; Ritter, J.; Nuber, B. *Angew. Chem.* **1995**, *107*, 725–727; *Angew. Chem. Int. Ed.* **1995**, *34*, 789–791.
213. Haberauer, G.; Gleiter, R.; Irngartinger, H.; Oeser, T.; Rominger, F. *J. Chem. Soc., Perkin Trans. 2* **1999**, 2093–2097.
214. Eliassen, G. Å.; Kloster-Jensen, E.; Rømming, C. *Acta Chem. Scand.* **1986**, *40*, 574–582.
215. Kloster-Jensen, E.; Rømming, C. *Acta Chem. Scand.* **1986**, *40*, 604–605.
216. Corriu, R. J. P.; Moreau, J. J. E.; Praet, H. *Organometallics* **1989**, *8*, 2779–2786.
217. Sakurai, H. *Chem. Lett.* **1988**, *3*, 485–486.
218. Yamaguchi, S.; Miyasato, M.; Tamao, K. *Chem. Lett.* **2003**, *32*, 1104–1105.
219. Butora, G.; Hudlicky, T.; Fearnley, S. P.; Stabile, M. R.; Gum, A. G.; Gonzalez, G. *Synthesis* **1998**, 665–681.
220. Sakurai, H.; Kira, M.; Kumada, M. *Bull. Chem. Soc. Jpn.* **1971**, *44*, 1167.
221. Sekiguchi, A.; Ichinohe, M.; Kabuto, C.; Sakurai, H. *Bull. Chem. Soc. Jpn.* **1995**, *68*, 2981–2988.
222. Gleiter, R.; Stahr, H.; Nuber, B. *Organometallics* **1997**, *16*, 646–650.
223. Gleiter, R.; Merger, M. *Angew. Chem.* **1997**, *109*, 2532–2546; *Angew. Chem. Int. Ed.* **1997**, *36*, 2426–2439.

AN OVERVIEW ON THE SYNTHESIS OF SUGAR IMINO ACIDS

Raquel G. Soengas* and Amalia Estévez

*Centro Singular de Investigación en Química Biológica y Materiales Moleculares, Campus Vida,
Universidad de Santiago de Compostela, Jenaro de la Fuente s/n, E-15782, Santiago de Compostela, Spain
(e-mail: rsoengas@udc.es)*

Abstract. *The synthesis of sugar-like imino acid derivatives along with their chemical applications are surveyed.*

Contents

1. Introduction
 2. Six-membered ring sugar imino acids
 - 2.1. Polyhydroxylated derivatives of pipercolic acid
 - 2.1.1. 3,4,5-Trihydroxypipercolic acids
 - 2.1.2. Other hydroxylated devivatives of pipercolic acid
 - 2.2. Polyhydroxylated piperidinic β -amino acids: aza-analogues of glucuronic acid
 - 2.3. Polyhydroxylated derivatives of isonipecotic acid
 3. Five-membered ring sugar imino acids
 - 3.1. Bulgecinine
 - 3.2. Trihydroxyproline derivatives
 4. Conclusions
- Acknowledgments
References

1. Introduction

Azasugars (imino sugars) are a unique class of compounds that act as transition state analogues with inhibiting properties against various glycosidases. Imino sugars have potential applications in medicine as antidiabetic, antiobesity and antiviral drugs and also as therapeutics for the treatment of some genetic disorders such as Gaucher disease.

Among the imino sugars displaying activity as glycosidase inhibitors, we can find several sugar imino acids, mainly hydroxylated pipercolic acid derivatives. Highly hydroxylated pipercolic acids provide an opportunity for the incorporation of a pyranose carbohydrate motif into amide libraries to produce diverse and novel compounds for biological evaluation.

In order to discover new peptide-based drugs, many structurally rigid non-peptide scaffolds have been designed. Insertion of these moieties into appropriate sites is a common approach to restrict the conformational degrees of freedom in small peptides and produces the specific three-dimensional structures required for binding to their receptors.¹ The replacement of simple amino acids by cyclic amino acids has been carried out in structure-activity relationship studies aimed towards investigating peptides with improved pharmacological profiles. Modified pipercolic acids, as well as prolines, have the potential to induce secondary structure in short peptidic sequences,² thus are useful building blocks for the preparation of

peptides and peptide mimetics. It should be recalled that despite additional hydroxyl groups not having an effect on the general structure of the peptide containing them, other properties can be affected. In particular, the peptides solubility in water is modified by the degree of hydroxylation.³

2. Six-membered ring sugar imino acids

Aza-pyranose imino acids are of great chemical and biological interest. Within this group there are polyhydroxylated analogues of pipercolic acid, isonipercolic acid and aza-analogues of glucuronic acid. These compounds either display biological activity or act as synthetic intermediates of pharmacologically valuable derivatives.

2.1. Polyhydroxylated derivatives of pipercolic acid

Pipercolic acid (homoproline or 2-piperidinecarboxylic acid) is a natural non-proteinogenic amino acid, a component of several secondary metabolites in plants and fungi.⁴ Pipercolic acid is also found in human physiological fluids as a metabolite of lysine and it is thought to play an important role in the central inhibitory aminobutyric acid system.⁵

Pipercolic acid is also a substrate of peptidic agents with interesting pharmacological activities such as the immunosuppressors rapamycin,⁶ FK506⁷ and immunomycin or the antitumor antibiotic sandramycin.⁸ Moreover, pipercolic acid is a precursor in the synthesis of biologically relevant derivatives such as synthetic peptides,⁹ local anaesthetics or potential enzyme inhibitors.¹⁰ Given its importance, a lot of effort has been devoted to the asymmetric synthesis of pipercolic acid.¹¹

Sugar-like pipercolic acids, besides being useful synthetic intermediates for the preparation of natural products and peptidomimetics, have displayed interesting biological properties, which prompted exhaustive studies focusing on their synthesis. Thus, there are many routes to sugar-like pipercolic acids already reported in literature. The vast majority of the reported procedures use readily available carbohydrate molecules as starting materials, which results in the formation of the products in an enantiomerically pure form. However, as the requirement for functional group protection makes the synthesis of certain analogues laborious and inefficient, other procedures have been developed, namely those based on the diastereoselective aldol reaction or cycloadditions.

2.1.1. 3,4,5-Trihydroxypipercolic acids

3,4,5-Trihydroxypipercolic acids can be regarded as aza derivatives of uronic acids, which are biologically relevant compounds.

It is widely known that D-glucuronic acid plays a crucial role in drug metabolism known as 'glucuronic acid conjugation'. Aza analogues of D-glucuronic acid are also potential β -glucuronidase inhibitors, acting as transition-state analogues. Glucuronidase is an enzyme that hydrolyzes a β -glycosidic bond of a terminal glucuronic acid residue in oligo- and polysaccharides. As glucuronidases are involved in the degradation of mammalian glycosaminoglycans, they play an important role in the development of mammalian organisms. In addition to this, inhibitors of β -glucuronidase are clinically important since they have recently been shown to have a protective effect against the mucosa damage and diarrhea induced by the antitumor camptotecin derivative CPT-11. 2,6-Dideoxy-2,6-imino-L-gulonic acid [(2*S*,3*R*,4*R*,5*S*)-3,4,5-trihydroxypipercolic acid] **5**, isolated from seeds of *Baphia racemosa*,¹² has proved to be an inhibitor of human liver β -D-glucuronidase.¹³ Many synthetic efforts were devoted to the preparation of this imino acid and the

early work, carried out in Prof. Fleet's research group, is particularly relevant.¹⁴ In 1986, Fleet and coworkers described the preparation of imino gulonic acid **5** from inexpensive glucurono-6,3-lactone **1**.^{14a,b} Thus, after inversion of the hydroxyl group in C-5 to give alcohol **2**, an azide displacement afforded azide **3**. Catalytic hydrogenation allowed the introduction of an amino functionality in **4** with overall retention of the configuration (Scheme 1). Deprotection of the anomeric position followed by catalytic hydrogenation afforded 6-dideoxy-2,6-imino-L-gulonic acid **5**.

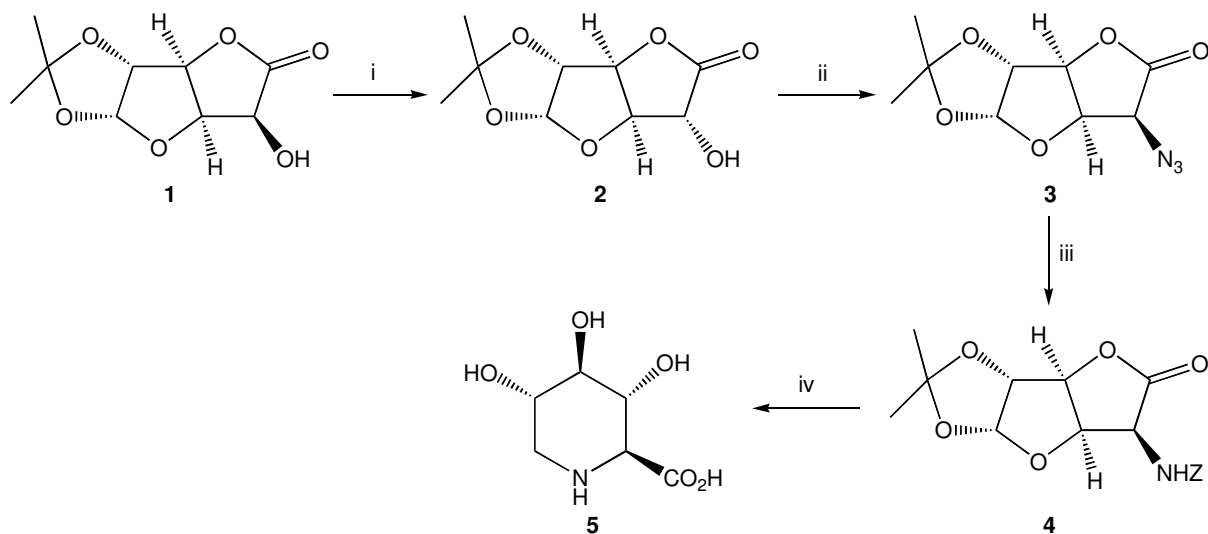

Reagents and conditions: (i) a) Tf_2O , Py, CH_2Cl_2 ; b) $\text{CF}_3\text{CO}_2\text{Cs}$, 2-butanone, reflux;
(ii) a) Tf_2O , Py, CH_2Cl_2 ; b) NaN_3 , DMF; (iii) a) H_2 , 10% Pd/C, EtOAc; b) Z-Cl, HNaCO_3 , EtOAc, H_2O ;
(iv) a) TFA/ H_2O ; b) H_2 , Pd black, $\text{H}_2\text{O}/\text{AcOH}$ (9:1).

Scheme 1

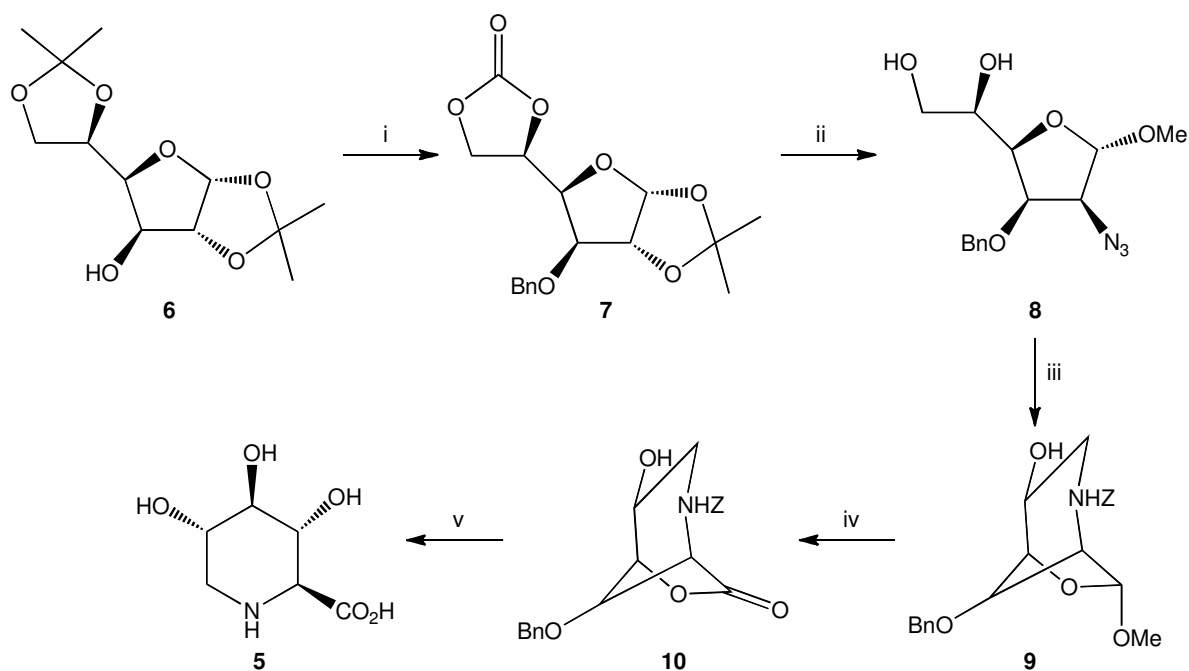

Reagents and conditions: (i) a) BrBn, NaH, NBu_4I , THF; b) AcOH/ H_2O , 50 °C; c) Cl_2CO , CH_2Cl_2 ;
(ii) AcCl, MeOH; b) Tf_2O , pyridine, CH_2Cl_2 ; c) NaN_3 , DMF; d) K_2CO_3 , MeOH; (iii) a) CITs, Py, CH_2Cl_2 ;
b) H_2 , Pd black, EtOAc; c) Z-Cl, HNaCO_3 , EtOAc, H_2O ; (iv) a) TFA/ H_2O ; b) Br_2 , BaCO_3 , 1,4-dioxane, H_2O ;
(v) a) H_2 , Pd black, EtOAc, pyridine; b) 0.1 M KOH, EtOH/ H_2O (1:1).

Scheme 2

Fleet and coworkers also developed a flexible route to several synthetic and naturally occurring 1,5-dideoxy-1,5-iminohexitols from D-glucose which, among others, allowed the preparation of (2*S*,3*R*,4*R*,5*S*)-3,4,5-trihydroxypipelic acid **5**. Thus, intermediate **9** was synthesized on a large scale from diacetone-D-glucose **6** via carbonate **7**.^{14c} From intermediate **9**, hydrolysis with aqueous trifluoroacetic acid and bromine oxidation of the resulting lactol afforded lactone **10**. Catalytic hydrogenation followed by basic hydrolysis afforded, after purification by ion exchange chromatography, imino acid **5** (Scheme 2).

In 1994, the synthesis of the 5*C* isomer (2*S*,3*R*,4*R*,5*R*)-3,4,5-trihydroxypipelic acid **14** was reported. The starting material was azido ester **11**, easily obtained from commercially available D-glucono- δ -lactone. After transformation of **11** into derivative **12**, the key step was an intramolecular nucleophilic amination to give **13**. Acidic hydrolysis of **13** afforded desired pipelic acid **14** (Scheme 3).¹⁵

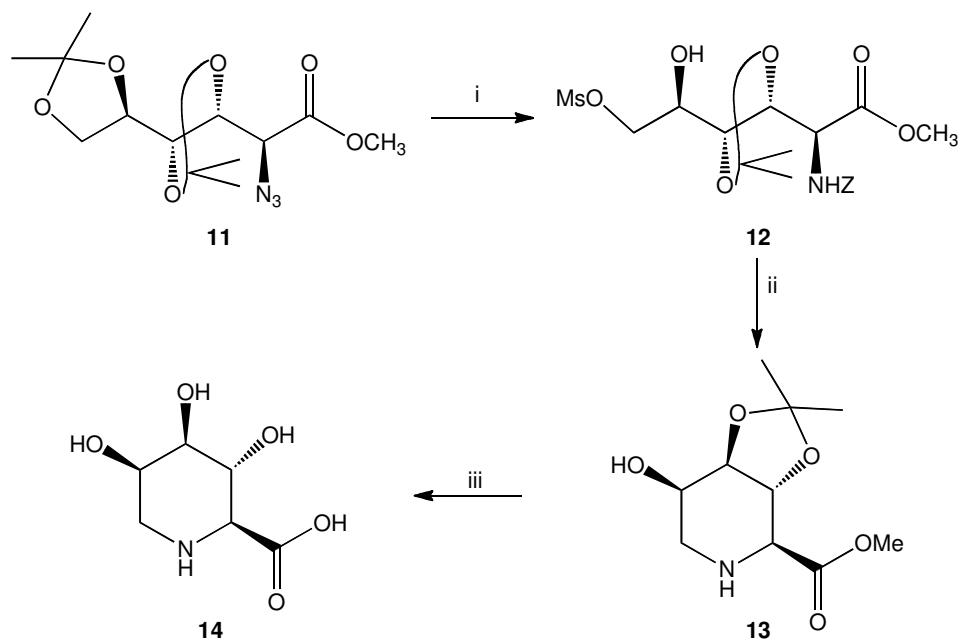

Reagents and conditions: (i) a) Pd-C, H₂, Z-Cl, K₂CO₃; b) DOWEX 50W, 90 % MeOH; c) MsCl, Et₃N, CH₂Cl₂; (ii) Pd-C, H₂, AcONa; (iii) HCl.

Scheme 3

In another example, the ability of aminocarbene complexes to serve as ketene equivalents under UV irradiation, which may be trapped by nucleophiles,¹⁶ was used for the transformation of pentacarbonyl [1,5-iminopyranosylidene] chromium complexes¹⁷ into imino derivatives of aldones in the *D-allo*-configuration.¹⁸

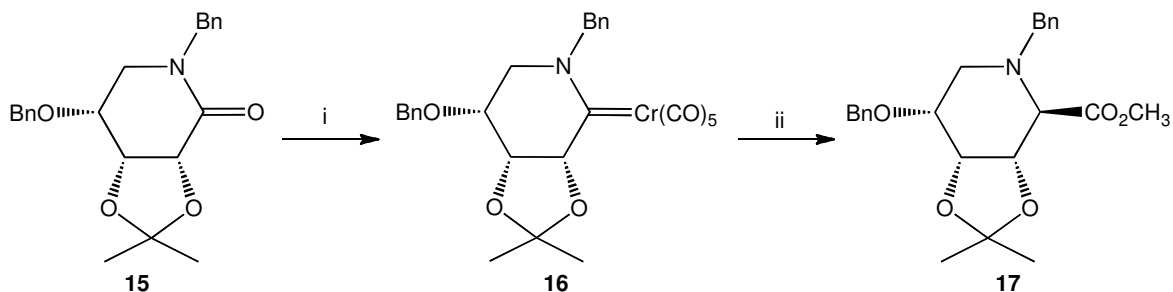

Reagents and conditions: (i) a) K₂Cr(CO)₅; b) TMSCl, THF, 62%; (ii) CH₃OH / hv, 59%.

Scheme 4

Chromium complex **16**, obtained from lactam **15**, was dissolved in methanol and irradiated with a 125 W mercury lamp at room temperature. The reaction produced the methyl 2,6-iminoaldonate **17** in moderate yield after oxidative and chromatographic workup (Scheme 4).¹⁹

(2*R*,3*R*,4*R*,5*S*)-3,4,5-Trihydroxypipelic acid **20** was obtained in good yields from **18**, easily available from L-gulonic acid γ -lactone. Intramolecular nucleophilic amination of **18** afforded amino ester **19**, which upon acidic hydrolysis gave pipelic acid **20** (Scheme 5).²⁰

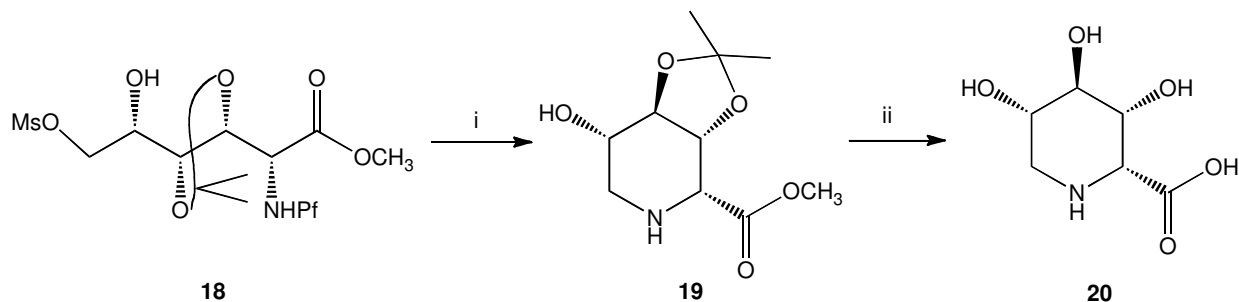

Reagents and conditions: (i) H₂/Pd-C, CH₃CO₂Na, MeOH, 40 °C (6 h) to reflux (8 h), 83 %;
 (ii) Dowex 50W-X8, THF/H₂O, reflux, 9 h, 84%.

Scheme 5

Regarding non-carbohydrate-based procedures, the synthesis of polyhydroxylated pipelic acids was accomplished *via* aldol reactions of chelated ester enolates.

For example, the aldol reaction of tosylated glycine ester **21** with chiral aldehyde **22** in the presence of 2.5 equivalents of SnCl₂ gave the corresponding aldol product **23** (Scheme 6). After protection of the hydroxyl group and desilylation, derivative **25** was transformed into the protected trihydroxypipelic acid **26** *via* a Mitsunobu reaction.²¹

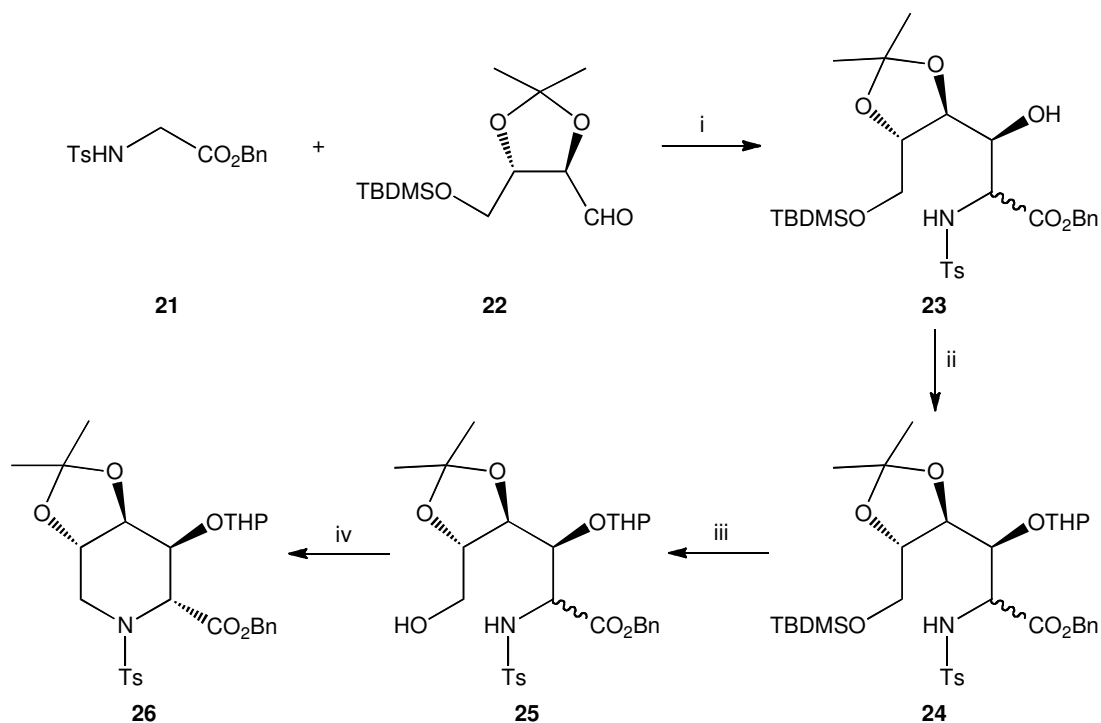

Reagents and conditions: (i) 2.5 eq. LDA, 2.5 eq. SnCl₂, THF, -78 °C, 30 min; (ii) 2 eq. DHP, CSA cat., CH₂Cl₂, 0 °C to r.t., 90 min, 83%; (iii) 2 eq. TBAF, THF, r.t., 2 h, 82%; (iv) 2.4 eq. PPh₃, 2.3 eq. DEAD, THF, r.t., 30 min., 92%.

Scheme 6

Another example is the straightforward preparation of trihydroxylated pipercolic acid derivatives from compounds such as **27**, obtained by the condensation of (*R*)-(-)-phenylglycinol with a mesotrihydroxylated glutaraldehyde²² (Scheme 7). Derivative **27** reacted with triethylsilane in the presence of titanium(IV) chloride to give **28**, and it could in turn be converted into the corresponding lactone **29** by the use of potassium carbonate in acetone. Catalytic hydrogenolysis of **29** caused simultaneous recovery of the carboxylic function, debenzoylation and removal of the chiral auxiliary, affording pipercolic acid **5**.²³

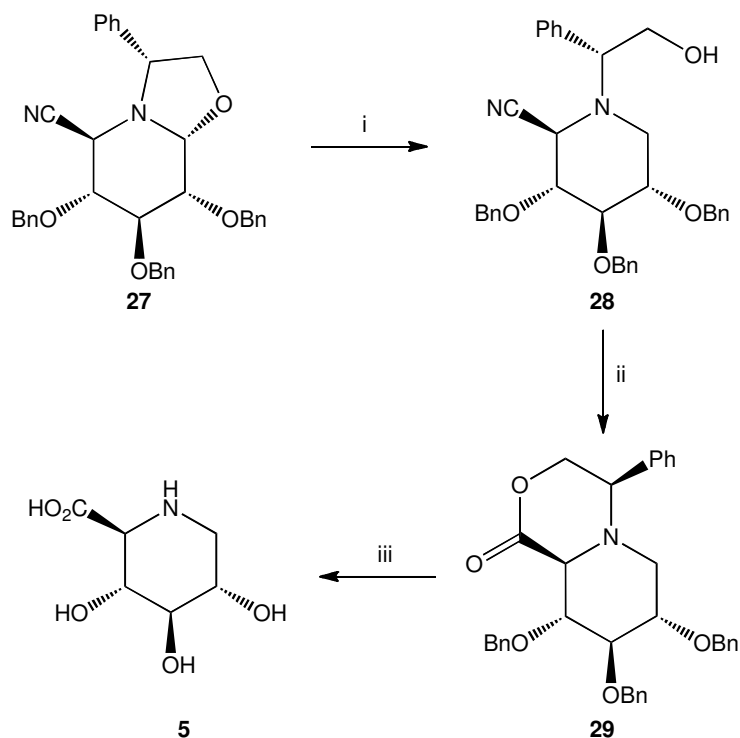

Reagents and conditions: (i) Et₃SiH, TiCl₄, CH₂Cl₂, 40%; (ii) K₂CO₃, acetone, TiCl₄, 60%; (iii) H₂, Pd(OH)₂/C, EtOH, 4 bar, 85%.

Scheme 7

A bislactim ether was used as glycine equivalent in the synthesis of trihydroxypipercolic acids based in an aldol reaction reported by Ruiz *et al.*²⁴ The key step was a highly diastereoselective reaction of tin(II) azaenolate **31** and aldehyde **30** to give compound **32**. Treatment of derivative **32** with anionic fluoride followed by mesylation of the resulting free hydroxyl group afforded compound **33**. Acidic hydrolysis and nucleophilic amination gave **34**, from which hydroxylated pipercolic acid derivative **35** was easily obtained (Scheme 8).

A methodology based on Diels-Alder cycloadditions has also been reported. By using appropriately substituted 1,4-oxazin-2-ones as azadienes, the [4+2] cycloaddition can regio- and stereoselectively bring together the heterocyclic ring, which through further chemo- and stereoselective transformations would afford target trihydroxypipercolic acid derivatives. Azadiene **36** underwent efficient cycloaddition with vinylene carbonate to afford a 2.5:1 *endo/exo* ratio of cycloadducts **37** and **38**. After replacement of the chloro substituents with methyl groups using palladium catalyzed Stille coupling, the major *endo* product **39** was isolated. Hydride reduction of the imine functionality of the *endo* bridged ester **39** followed by methanolysis and basic hydrolysis gave a very good yield of azasugar **40** (Scheme 9).²⁵

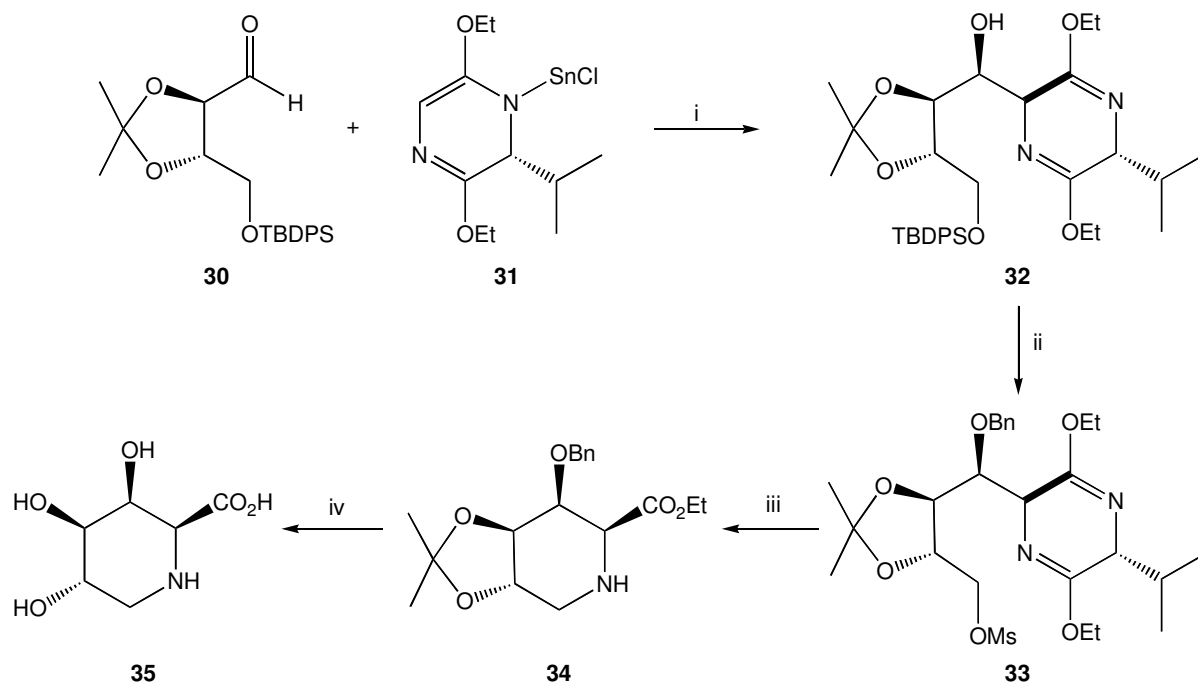

Reagents and conditions: (i) THF, $-78\text{ }^{\circ}\text{C}$, 1 h, 79%, *de* > 90%; (ii) a) NaH, BnBr, NBu_4I , 24 h, r.t., 75%;
 b) TBAF, THF, r.t., 4 h, 95%; c) MsCl, Et_3N , DMAP, CH_2Cl_2 , r.t., 1 h, 100%; (iii) a) 0.25M HCl/EtOH 1:2, 9 h, 65%;
 b) DMSO, Et_3N , $70\text{ }^{\circ}\text{C}$, 2 h, 85%; (iv) a) 0.25M HCl/THF 1:1, H_2 , Pd/C, r.t., 9 h; b) Dowex- H^+ , 88%.

Scheme 8

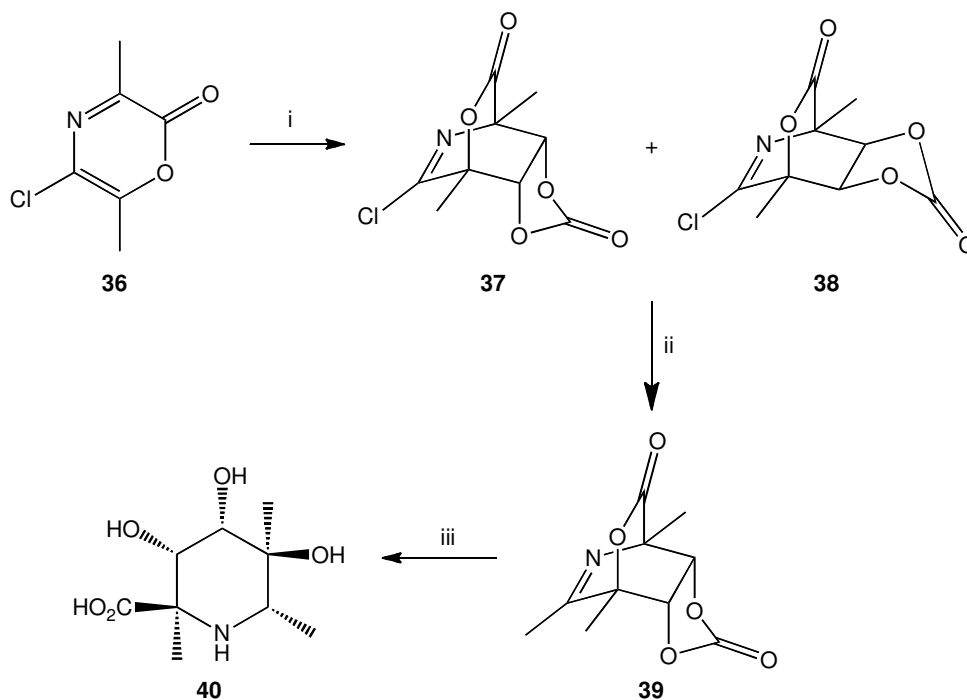

Reagents and conditions: (i) a) Toluene, reflux 24 h, vinylene carbonate, 74%; (ii) a) toluene, reflux, 48 h, Me_4Sn ,
 Pd(PPh_3) $_4$, 92%; (iii) a) HOAc, $\text{NaBH}(\text{OAc})_3$, r.t., 24 h, 67%; b) MeONa (1 equiv), MeOH, reflux, 30 min., 49%;
 c) 2 M aq. NaOH, r.t., 1 h, quant.

Scheme 9

Dibromohexonolactones showed to be valuable precursors for obtaining imino acid derivatives in only three steps without any need for protecting groups. For example, 2,6-dibromo-2,6-dideoxy-D-galactono-1,4-lactone **42**, easily available from D-galactono-1,4-lactone **41**, was transformed into 2-amino-6-bromo-2,6-

dideoxy-D-galactono-1,4-lactone **43** by means of azide displacement followed by catalytic hydrogenation. Lactone **43** is a suitable starting material for the preparation of 1,5-iminuronic acid analogues **44** and **45** with L-galacto- and D-althro configuration respectively (Scheme 10).²⁶

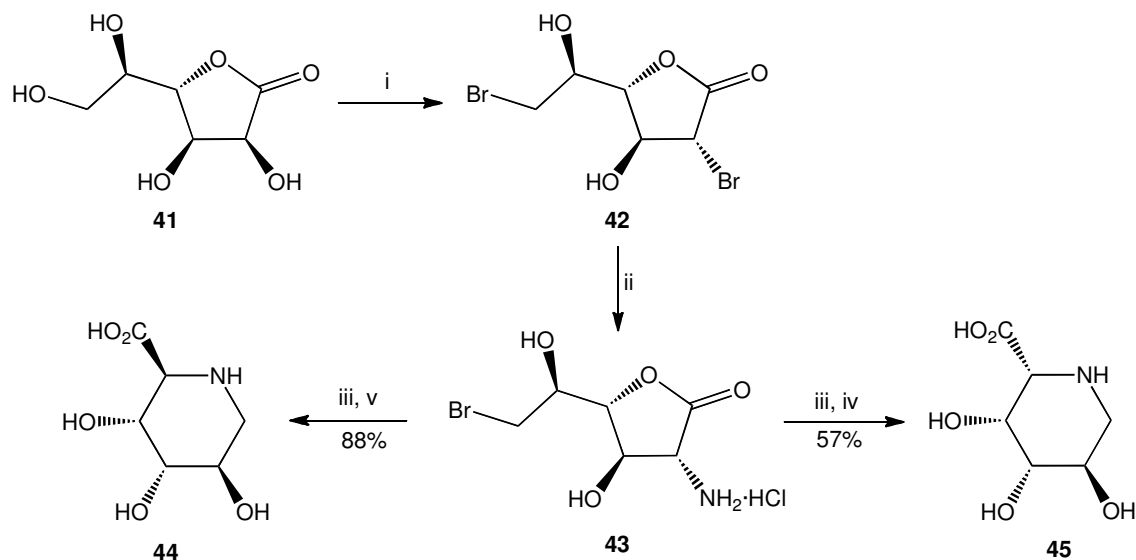

Reagents and conditions: (i) HBr, AcOH, r.t.; (ii) a) NaN_3 , acetone, reflux, 34%; b) H_2 , Pd/C, MeOH, HCl, quant.; (iii) 5 eq. KOH, H_2O , 0 °C; (iv) 3 eq. Et_3N , MeOH, 0 °C; (v) Amberlite IR-120 H^+ , aq. NH_3 .

Scheme 10

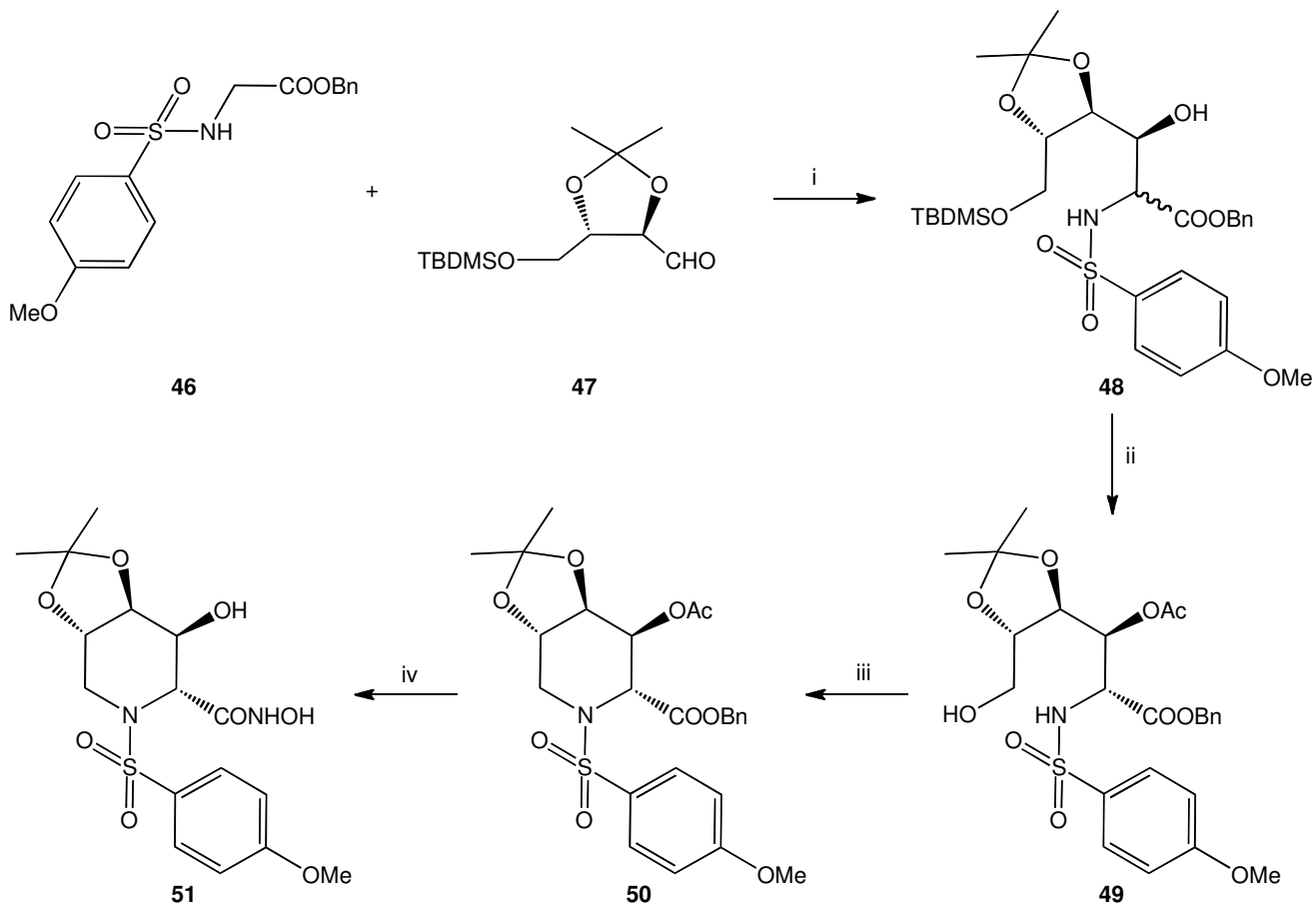

Reagents and conditions: (i) LDA, SnCl_2 ; (ii) a) Ac_2O , pyridine; b) TBAF, AcOH, THF; (iii) DEAD, Ph_3P , THF; (iv) a) Pd/C, H_2 ; b) NH_2OBn , WSC, HOBT; c) NaOMe, MeOH.

Scheme 11

Several amido derivatives of trihydroxypipelicolic acid have shown biological activity as metalloproteinase inhibitors.²⁷ Metalloproteinases, a family of zinc-containing enzymes, mediate the breakdown of connective tissue²⁸ and are therefore targets for therapeutic inhibitors in many inflammatory, malignant and degenerative diseases such as rheumatoid arthritis,²⁹ multiple sclerosis³⁰ and type II diabetes.³¹ Hence, there is a great interest in metalloproteinase inhibitors for medicinal chemists.³²

Azasugars proved to be particularly useful as metalloproteinase inhibitors as they could attain a much larger improvement in water solubility, compared to other classes of inhibitors. For example compound **51**, easily obtained from L-threitol derivative **47** as depicted in Scheme 11, exhibited inhibitory activities against MMP-1, -3, and -9.³³ Aldol condensation of **46** and derivative **47** afforded sulfonamide **48**. Deprotection of the primary hydroxyl group to give **49** followed by an intramolecular Mitsunobu reaction afforded derivative **50**, which was transformed into desired imino sugar **51** in three steps.

2.1.2. Other hydroxylated derivatives of pipelicolic acid

3-Deoxy derivative of 2,6-dideoxy-2,6-imino-L-gulonic acid **5**, namely 2,3,6-trideoxy-2,6-imino-L-gulonic acid **55**, has been isolated from the leaves of *Derris elliptica*³⁴ and has also been regarded as an inhibitor of glucuronidases. Several syntheses of this derivative have been reported; for example, Fleet *et al.* synthesized **55** from inexpensive protected glucurono-6,3-lactone **1**.^{14a,b} Thus, after introduction of the amino functionality in C-5 with inversion of configuration, treatment of the resulting protected lactone **52** with base caused a fragmentation to give (after treatment with sodium borohydride) the unsaturated diol **53**. Selective formation of the primary mesylate, followed by catalytic hydrogenation, gave amino mesylate **54**. Treatment of **54** with potassium hydroxide, followed by purification by ion exchange chromatography, gave dihydroxypipelicolic acid **55** (Scheme 12).

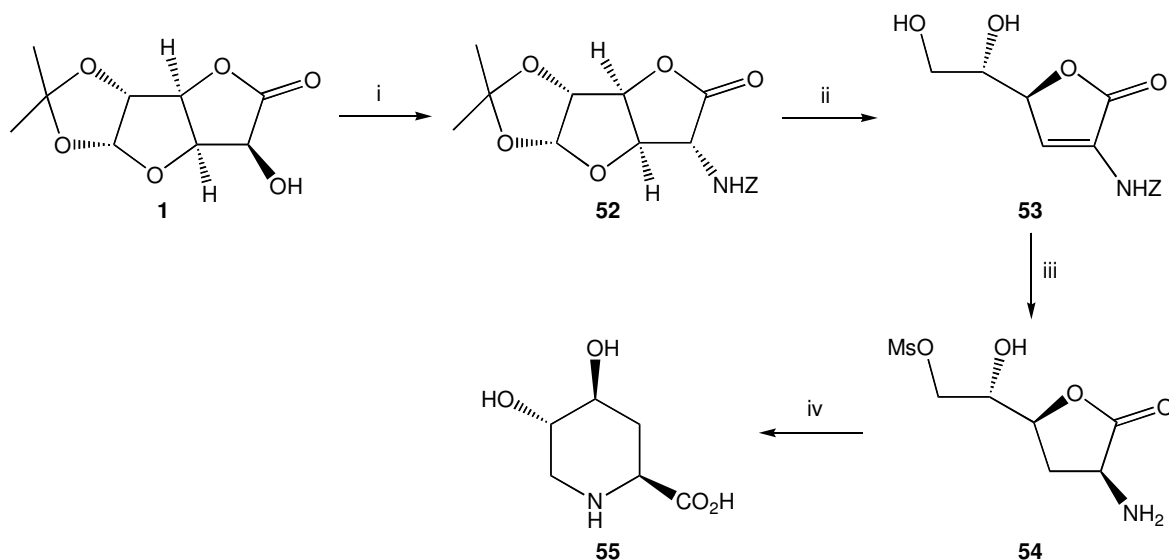

Reagents and conditions: (i) a) TiF_4 , Py, CH_2Cl_2 ; b) NaN_3 , DMF; c) H_2 , 10% Pd/C, EtOAc; d) Z-Cl, $\text{HN}(\text{Na})\text{CO}_3$, EtOAc, H_2O ; (ii) a) MeONa/MeOH; b) NaBH_4 , MeOH; (iii) a) MsCl, Py; b) H_2 , Pd black, EtOAc, Py; (iv) 0.1 M KOH in EtOH/ H_2O (1:1).

Scheme 12

2,3,6-Trideoxy-2,6-imino-L-gulonic acid **55** was also prepared from **56**, obtained from readily available diacetone-D-glucose **6**. Removal of the C-3 hydroxyl group in **56** to form **57**, followed by deprotection of the free hydroxyl group, gave **58**. Oxidation of the primary hydroxyl group in **58** to the

The synthesis of the tetrahydroxypipercolic acid moiety has also been reported. Thus, mannopyranoside mimics **72** and **73** were found to be specific and potent inhibitors of some *N*-acetylglucosaminidases were synthesized from azido-ketone **67**.³⁸ Reduction of **67** by phosphate, followed by a concomitant aza-Wittig reaction, resulted in formation of bicyclic imine lactone **68** (Scheme 15). Subsequent reduction of the bicyclic iminolactone resulted in stereoselective reduction of the imine to give bicyclic lactone **69**. Acidic hydrolysis of lactone **69** afforded mannopyranoside mimic **70**, while ring opening gave the ester **71**, which allowed the generation of mannopyranoside mimic **72**.

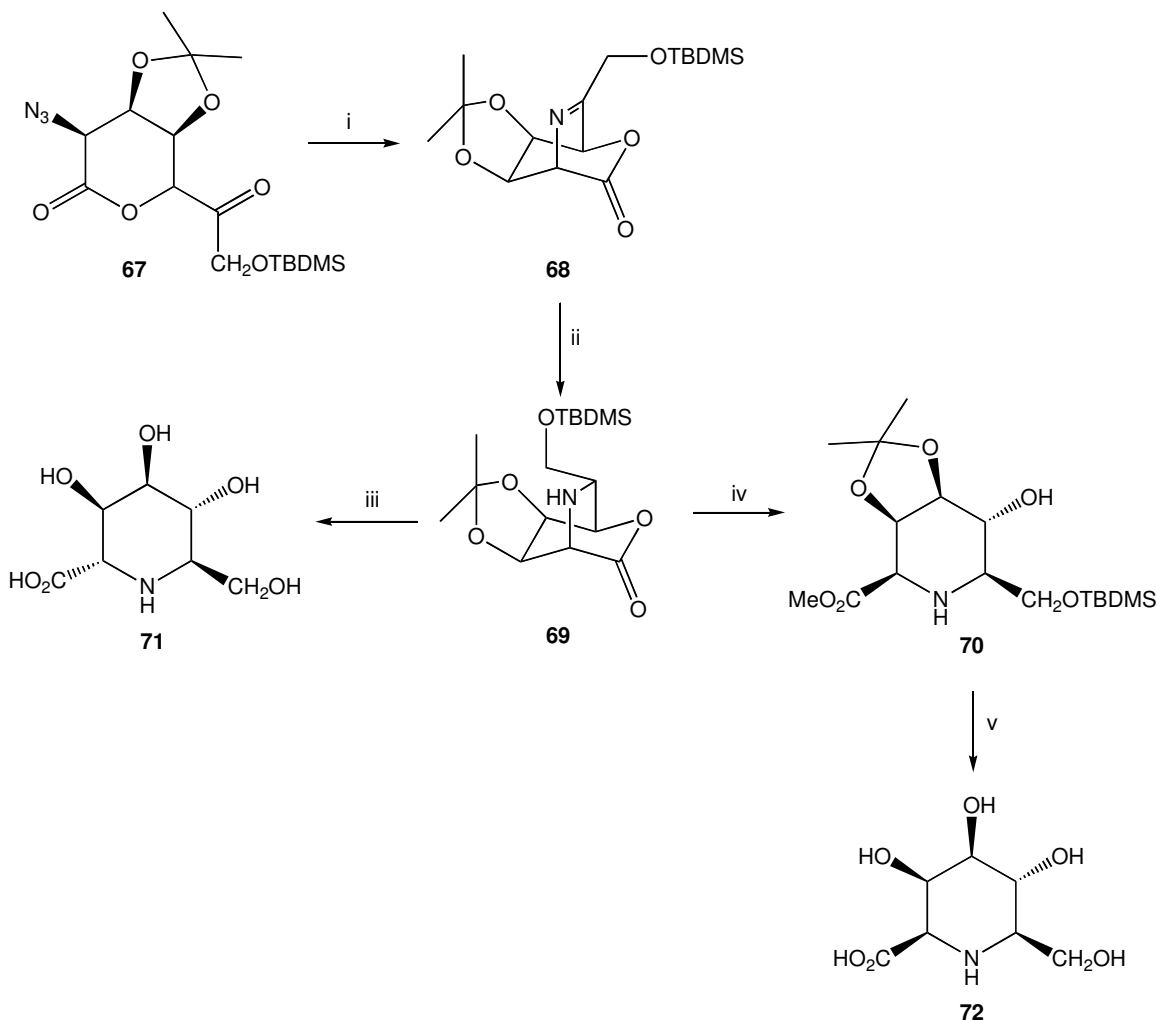

Reagents and conditions: (i) P(OEt)₃; (ii) NaBH₃CN, AcOH, 70%; (iii) TFA (aq), 86%; (iv) Na₂CO₃, MeOH, 59%; (v) a) TFA (aq); b) NaOH (aq) then HCl (aq), 62% two step.

Scheme 15

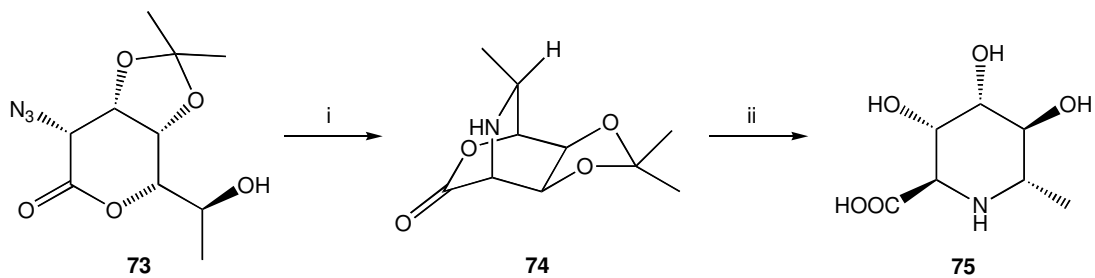

Reagents and conditions: (i) a) Tf₂O, Py, CH₂Cl₂, -20 °C; b) H₂, Pd, NaOAc, EtOAc, 61% two steps; (ii) a) NaOH (aq); b) HCl (aq), 90% two steps.

Scheme 16

A similar procedure was used for the preparation of the sugar imino acid **75** with the structure of rhamnose, which was used to prepare imino-C-glycosyl amides, found to be potent and selective competitive inhibitors of naringinase.³⁹ Treatment of azidolactone **73** with triflic anhydride gave the bicyclic lactone **74** *via* formation of corresponding triflate, followed by *in situ* intramolecular amination. Imino acid **75** was easily obtained by treatment with sodium hydroxide, followed by acidic hydrolysis (Scheme 16).

2.2. Polyhydroxylated piperidinic β -amino acids: aza-analogues of glucuronic acid

Some naturally occurring amino acids that display interesting biological activities are azapyranose-like β -imino acids. For example, siastatin B **84** is a neuraminidase inhibitor, which was isolated from a *Streptomyces* culture and then synthesized from L-ribose, as depicted in Scheme 17.⁴⁰ Starting from azidolactone **76**, imino sugar **77** was obtained in six steps. Oxidation to the corresponding ketone, followed by a Henry reaction, gave a nitro sugar intermediate **78**. After β -elimination, Nef reaction of the formed nitroalkene **79** gave unsaturated ester **80**, which was transformed into siastatin B **81** in two steps.

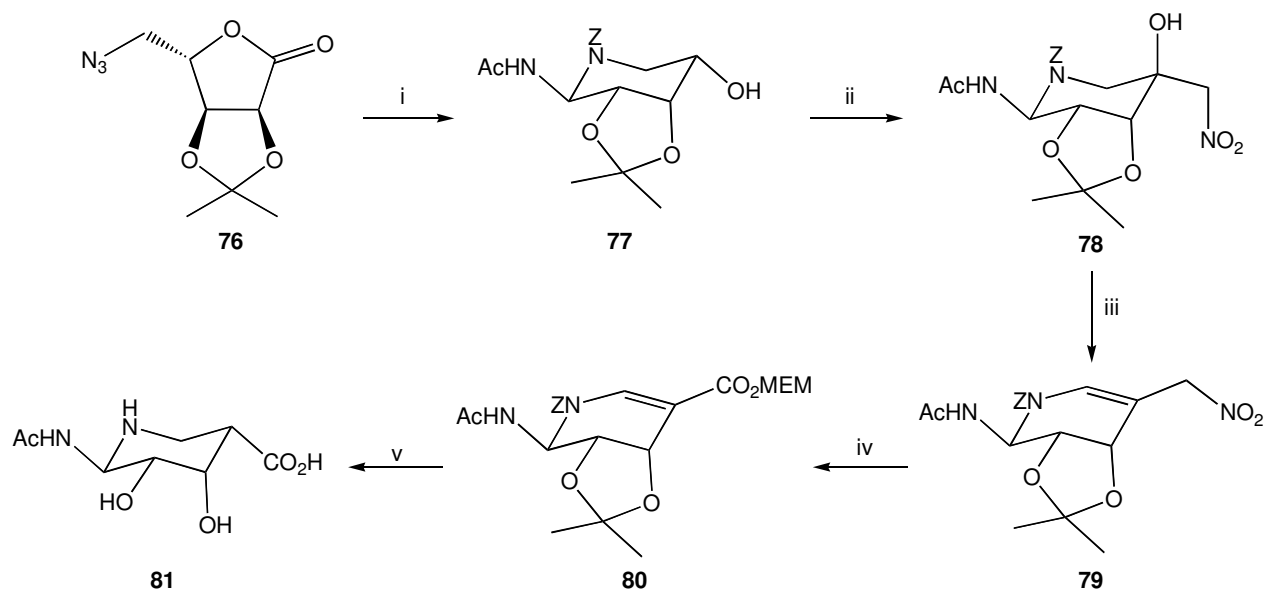

Reagents and conditions: (i) a) H₂, Raney Ni, MeOH, 88%; b) TBDMSCl, Im, DMF; c) Z-Cl, NaH, DMF, 99% (two steps); d) NaBH₄, EtOH, 70%; e) (COCl)₂, DMSO, Et₃N, CH₂Cl₂, 88%; f) phthalimide, Ph₃P, DEAD, DMF, 100%; g) NH₂NH₂, MeOH, Ac₂O, Py, 100%; h) TBAF, THF, 100%; (ii) a) RuO₄, CH₂Cl₂/CCl₄, 99%; b) CH₃NO₂, NaH, DME, 100%; (iii) *p*-TsOH, Ac₂O; K₂CO₃, C₆H₆, 100%; (iv) a) Py, 38 °C, 80%; b) CH₃CH=C(CH₃)₂/*t*-BuOH, NaOCl₂, NaH₂PO₄, H₂O; MEMCl, (*i*-Pr)₂NEt, CH₂Cl₂, 55%; (v) a) NaBH₄, 1:10 CF₃CH₂OH/THF, 75%; b) PDC, DMF; c) H₂, 5% Pd/C, MeOH; d) 1 M aqueous HCl, then Dowex 50W-X4 (H⁺ form) eluted with NH₄OH, 66%.

Scheme 17

Several analogues of siastatin B were also synthesized, one of which is the 2-(trifluoroacetamido)-3,4,5-trihydropiperidine-5-carboxylic acid **87**.⁴¹ The synthetic route, laid out in Scheme 18, also uses a Henry reaction as the key step. Starting from imino sugar **82**, treatment with tetrabutylammonium fluoride gave alcohol **83**, which was then oxidized to ketone **84**. A Henry reaction with nitromethane gave nitro derivative **85**. Transformation of the nitromethyl moiety into a carboxylic acid group afforded **86**. Finally, acidic hydrolysis formed the desired imino acid **87**.

The other siastatin B derivative, (3*S*,4*S*,5*R*,6*R*)-6-(trifluoroacetamido)-4,5-dihydroxy-3-piperidine carboxylic acid **92**, displayed inhibitory effects of pulmonary metastasis of B16 melanoma.⁴² The key step in the preparation of **92** is a Wacker oxidation of the enol ethers **89** and **90**. These derivatives are prepared by

the one-carbon homologation of the ketone **88** using the Wittig reaction to produce the derivative **91**. Catalytic hydrogenation followed by acidic hydrolysis gave the intended imino sugar **92** (Scheme 19).

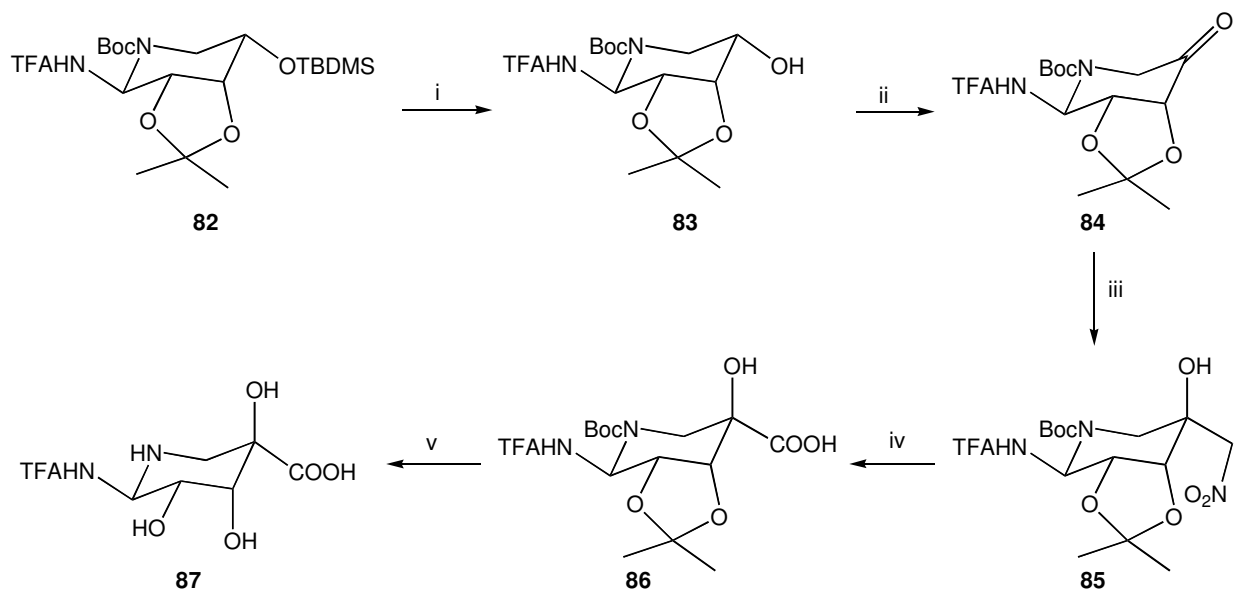

Reagents and conditions: (i) TBAF, THF, quantitative; (ii) RuO₄, CCl₄, CH₂Cl₂, quantitative; (iii) 1,2-dimethoxyethane, nitromethane, NaH, 74%; (iv) a) Ni-Raney, MeOH, 98%; b) ninhydrin, HNaCO₃, MeOH, H₂O; c) 2-methyl-2-butene, NaClO₂, NaH₂PO₄, 2-methyl-2-propanol, 43% two steps; (v) TFA/H₂O, quantitative.

Scheme 18

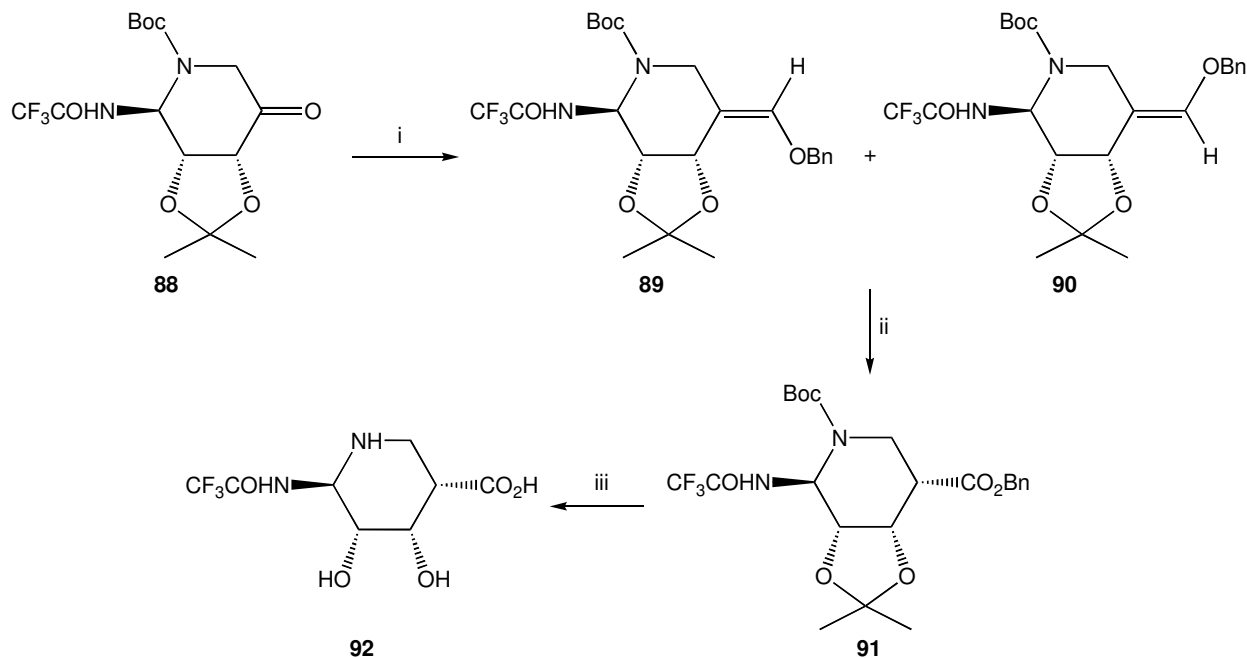

Reagents and conditions: (i) (Benzyloxymethylene)triphenylphosphorane, THF, -68 °C to r.t., 4.5 h, 48%; (ii) PdCl₂, CuCl, DMF-H₂O (10:1), 70 °C, 25 h, then r.t. 61 h, 31%; (iii) a) Pd-C, EtOAc, r.t., 2 h, 92%; b) HCl aqueous 4M, dioxane, r.t., 15 h, 92%.

Scheme 19

In 2000, a more efficient route to siastatin B (**81**, 13 steps) from the resolved piperidine carboxylate **93** was discovered.⁴³ Bromolactonization of unsaturated carboxylate (*R*)-**93** to give **94**, followed by reduction to the bromodiol **95** and then elimination, afforded alkene **96**. Oxidation of the double bond, followed by treatment with dimethoxypropane and *p*-toluenesulphonic acid, gave **97**. Treatment of derivative **97** with

trimethylsilylazide, followed by catalytic hydrogenation in the presence of acetic anhydride, afforded **98**, which was easily transformed into siastatin B **81** in three steps (Scheme 20).

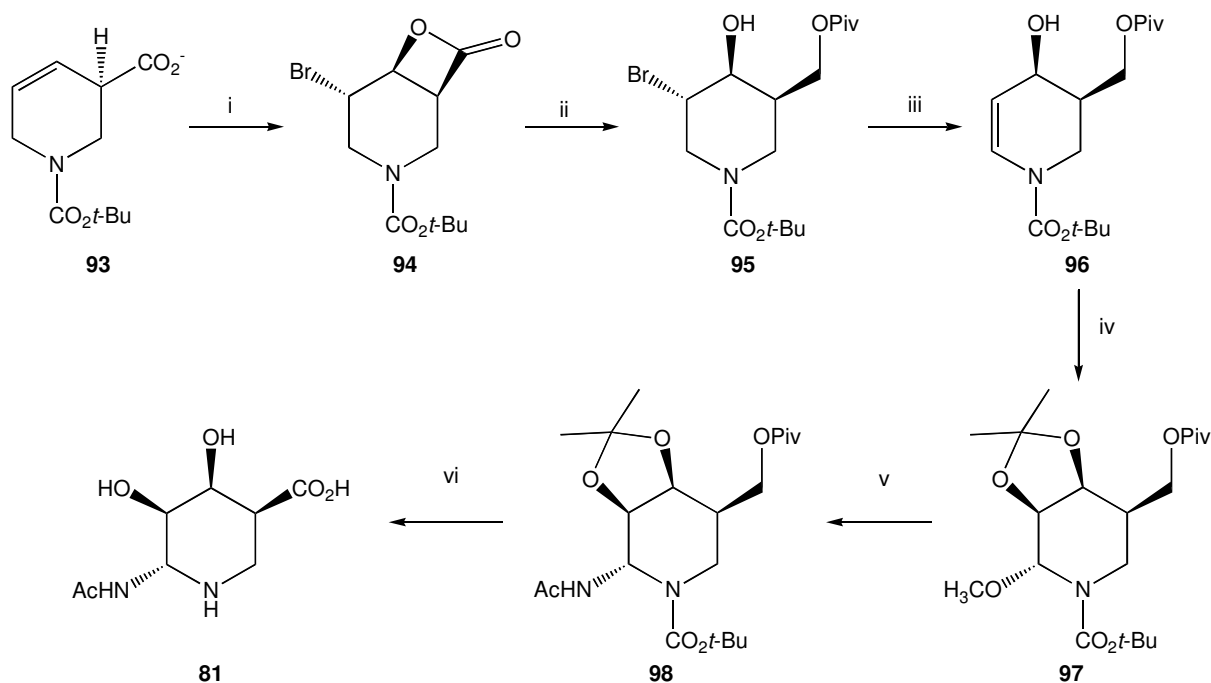

Reagents and conditions: (i) Br₂, CH₂Cl₂, -78 °C, 71%; (ii) a) LiBH₄, ether; b) Piv-Cl, pyridine, DMAP, CH₂Cl₂, 82% overall; (iii) a) Ac₂O, pyridine, DMAP, THF, 40 °C; b) DBU, toluene, 80 °C; c) guanidine, EtOH, CH₂Cl₂, 66% overall; (iv) a) MCPBA, MeOH, CH₂Cl₂, 0 °C; b) Me₂C(OMe)₂, TsOH, 68% overall; (v) a) TMSN₃, BF₃·OEt₂, CH₂Cl₂, -40 °C; b) H₂, Pd-C, Ac₂O, 72% overall; (vi) a) *n*-Bu₄NOH, MeOH; b) PDC, DMF; c) TFA, H₂O, then HCl, EtOH, 67% overall.

Scheme 20

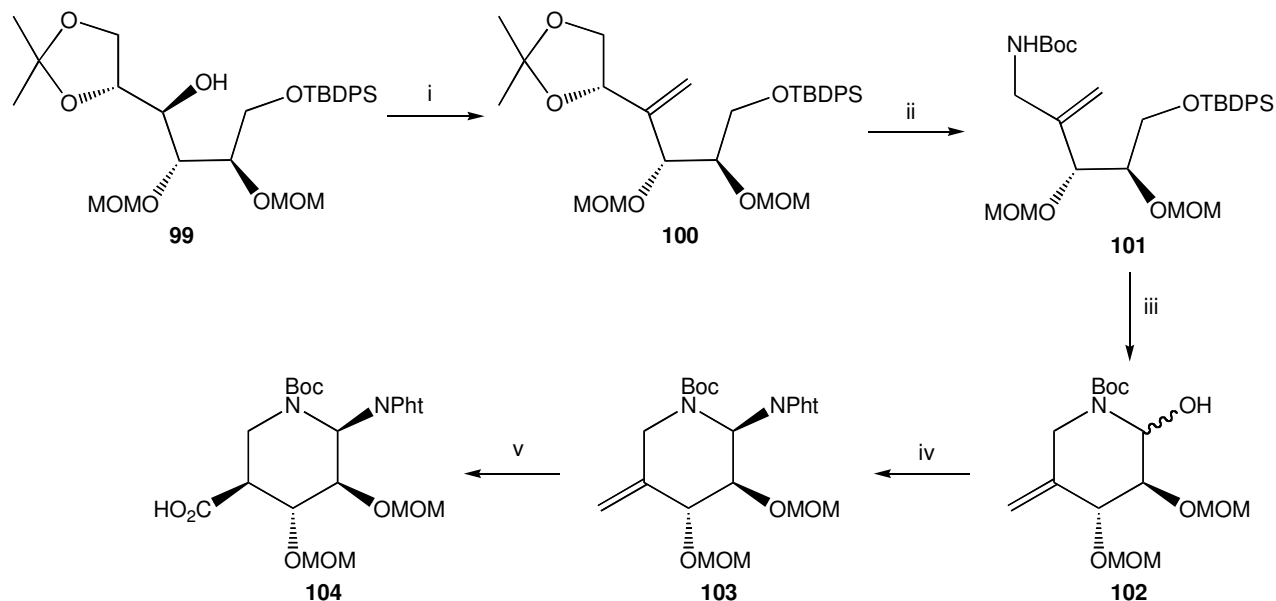

Reagents and conditions: (i) a) Dess-Martin periodinane, CH₂Cl₂, 93%; b) Ph₃PCH₃Br, *n*-BuLi, THF, -78 °C, 96%; (ii) a) 80% AcOH, r.t., 99%; b) NaIO₄, CH₃CN/H₂O; NaBH₄, CeCl₃, MeOH, 88%; c) MsCl, pyridine; d) NaN₃, DMF, 88.7%; e) Te, NaBH₄, EtOH; f) (*t*-BuCO)₂O, *i*-Pr₂NEt, DMF, 88%; (iii) a) TBAF, THF, 100%; b) (COCl)₂, DMSO, CH₂Cl₂, 93%; (iv) PPh₃, DEAD, phthalimide, DMF; (v) a) BH₃·Me₂S, THF; H₂O₂, 2M NaOH/H₂O, 38%; b), MeOH, H₂NNH₂·H₂O; (CF₃CO)₂O, pyridine, 79%; d) chromatographic separation; e) RuO₂, NaIO₄, CCl₄/CH₃CN/H₂O, 87%.

Scheme 21

The same year, an efficient and flexible route to *gem*-diamine 1-*N*-iminosugars of uronic acid-type **107** from derivative **99** was reported.⁴⁴ Oxidation of **99**, followed by the Wittig reaction, afforded compound **100**. After undergoing acidic hydrolysis, oxidative cleavage of the resulting diol, reduction and amination of the formed hydroxyl gave amine **101**. Deprotection of the primary hydroxyl group, followed by a Mitsunobu reaction, formed the 1-*N*-iminopyranose ring in **102**. After introduction of the amino group in C-1 and chromatographic separation to give diamine **103**, oxidation of the alkene afforded imino sugar **104** (Scheme 21).

In 2006, Brown *et al.* prepared *gem*-diamine 1-*N*-iminosugar **109**, related to L-iduronic acid, which is a potent inhibitor of a central sulfotransferase involved in heparan sulfate biosynthesis.⁴⁵ Thus, starting from **105**, easily obtainable from siastatin B, *cis*-oxiamination gave the oxazoline **106**. Hydrolysis of the oxazoline of **106** to give **107**, followed by reductive cleavage of the trichloroacetyl group, afforded **108**. Acidic hydrolysis of compound **108** gave imino sugar derivative **109** (Scheme 22).

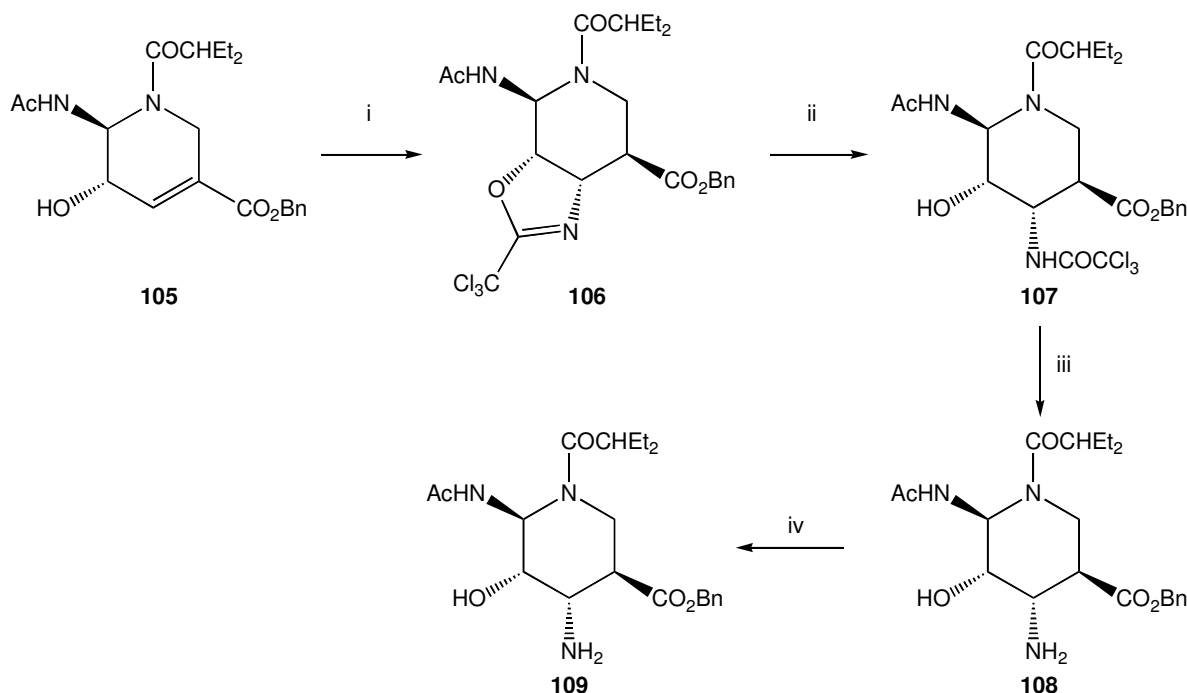

Reagents and conditions: (i) CCl_3CN , DBU, CH_2Cl_2 , r.t., 30 min, 64%; (ii) *p*-TsOH, pyridine/ H_2O , 80 °C, 2 h, 77%; (iii) NaBH_4 , EtOH, r.t., 2 h, 57%; (iv) 4 M HCl/dioxane, r.t., 12 h, 93%.

Scheme 22

Sugar imino acid **113** was synthesized from D-arabinose derivative **110** in a strategy involving reductive amination to give **111** followed by the introduction of an exo-methylene group at C-5, hydroboration and subsequent oxidation of the hydroxymethyl group to the corresponding carboxylate **112**. Acidic hydrolysis of **112** finally afforded imino acid **113** (Scheme 23).⁴⁶

Sugar imino acid **119** was synthesized in high overall yield from methyl nicotinate **114**. The synthetic strategy relied on a regioselective and high-yielding reduction of **114**, together with efficient and stereoselective functionalization of the resulting 1,2-dihydropyridine **115** by means of an oxidation to unsaturated ketone **116**, reduction to allylic alcohol **117** and asymmetric dihydroxylation to afford derivative **118**. Finally, basic hydrolysis yielded the desired imino acid **119** (Scheme 24).⁴⁷

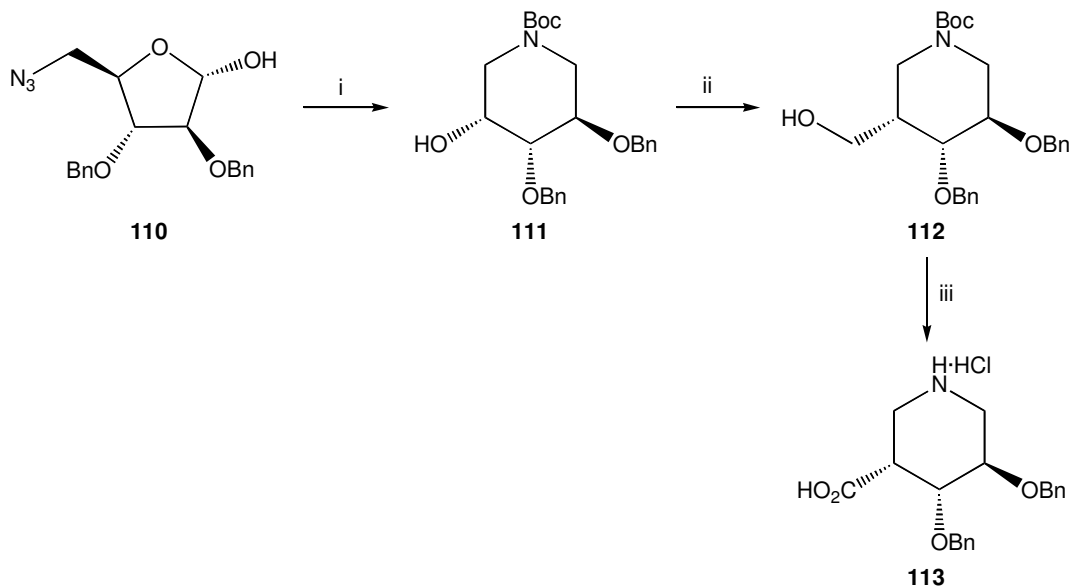

Reagents and conditions: (i) a) H_2 , Lindlar catalyst, MeOH; b) Boc_2O , Et_3N , MeOH; (ii) a) DMSO, $(\text{COCl})_2$, CH_2Cl_2 , -78°C then Et_3N , -78 to 0°C ; b) $\text{LiN}(\text{TMS})_2$, $\text{CH}_3\text{PPh}_3^+\text{Br}^-$, DME, 0°C to r.t.; c) 9-BBN, THF, 0°C to r.t.; d) NaOH 30%, H_2O_2 , r.t.; (iii) a) DMSO, $(\text{COCl})_2$, CH_2Cl_2 , -78°C then Et_3N , -78 to r.t.; b) NaClO_2 , 35% H_2O_2 , CH_3CN -phosphate buffer, 0°C to r.t.; c) 1 N HCl, r.t.

Scheme 23

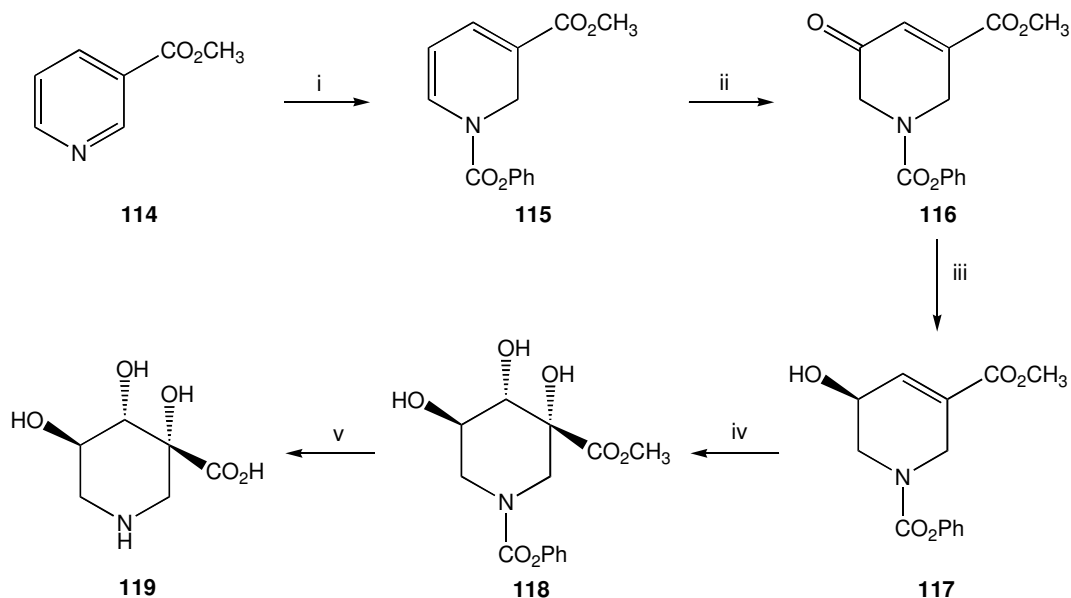

Reagents and conditions: (i) NaBH_4 , PhOCOCl , CH_3OH , -78°C , 97%; (ii) a) MCPBA, CH_2Cl_2 , -70 to 0°C , 92%; b) TMSOTf, $\text{BH}_3 \cdot \text{THF}$, -70 to 0°C , 77%; c) CrO_3 , acetone; (iii) LiAlH_4 , (-)-*N*-methyl-ephedrine, THF, 83%; (iv) OsO_4 , NMO, 81%; (v) LiOH (2 equiv), 95%.

Scheme 24

In 2000, the Ichikawa group described an efficient synthetic approach that provides the easy access to 1-*N*-iminosugar derivative of glucuronic acid **125**, starting from a readily obtainable (*R*)-2,3-*O*-cyclohexylidene-glyceraldehyde **120**.⁴⁸ Horner-Emmons condensation of **120** followed by reduction, Sharpless epoxidation and ring opening with cyanide afforded **121**, which was then transformed into derivative **122**. Catalytic hydrogenation of the nitrile, followed by subsequent intramolecular amination, gave **123**. Treatment with anionic fluoride and oxidation of the obtained hydroxymethyl group afforded carboxylic acid **124**. Acidic hydrolysis of **124** finally yielded the desired sugar imino acid **125** (Scheme 25).

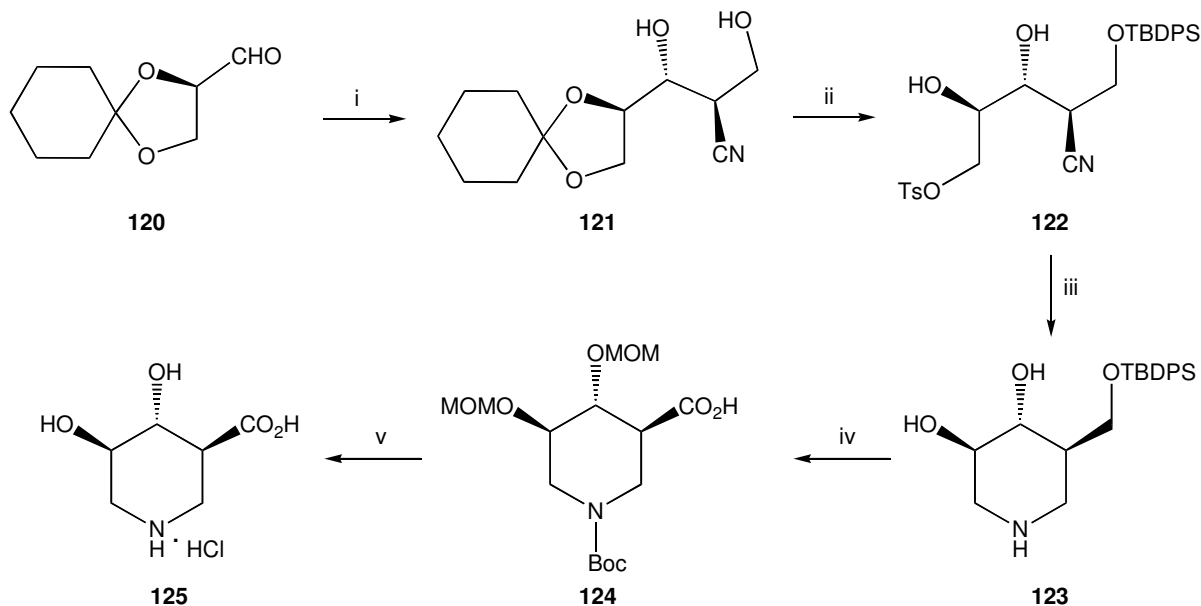

Reagents and conditions: (i) a) $(\text{MeO})_2\text{P}(\text{O})\text{CH}_2\text{CO}_2\text{Me}$, NaH, benzene/THF ($E:Z=10:1$, 83%); b) DIBAL, CH_2Cl_2 , 92%; c) $\text{Ti}(\text{O}-i\text{Pr})_4$, (+)-diethyl tartrate, $t\text{BuOOH}$, CH_2Cl_2 , 90%; d) KCN, Bu_4NI , $\text{Ti}(\text{O}-i\text{Pr})_4/\text{DMSO}$; (ii) a) TBDPSCl, imidazole, DMF, 88%; b) 80% AcOH; c) $p\text{-TsCl}$, Py, 70%; (iii) H_2 , Raney Ni, EtOH; (iv) a) Boc_2O , $\text{Et}_3\text{N}/\text{MeOH}$, 62%; b) MOMCl, $i\text{-Pr}_2\text{NEt}/\text{CH}_2\text{Cl}_2$, c) TBAF, THF, 74%; (v) (c) $(\text{COCl})_2$, DMSO/ $\text{Et}_3\text{N}/\text{CH}_2\text{Cl}_2$; d) H_2O_2 , NaClO₂, NaHPO₄, $\text{CH}_3\text{CN}/\text{H}_2\text{O}$, 82% in two steps; (v) 3 N HCl, 89%.

Scheme 25

In 2008, a new synthetic route to 1-*N*-iminosugars of glucuronic acid type was developed, employing a proline-catalyzed aldol reaction as a key step.⁴⁹ Thus, direct cross aldol condensation of aldehydes **126** and **127** in the presence of proline, followed by oxidation of the resulting unstable aldols and benzyl ester protection, provided esters **128** and **129**, which were separated by chromatography.

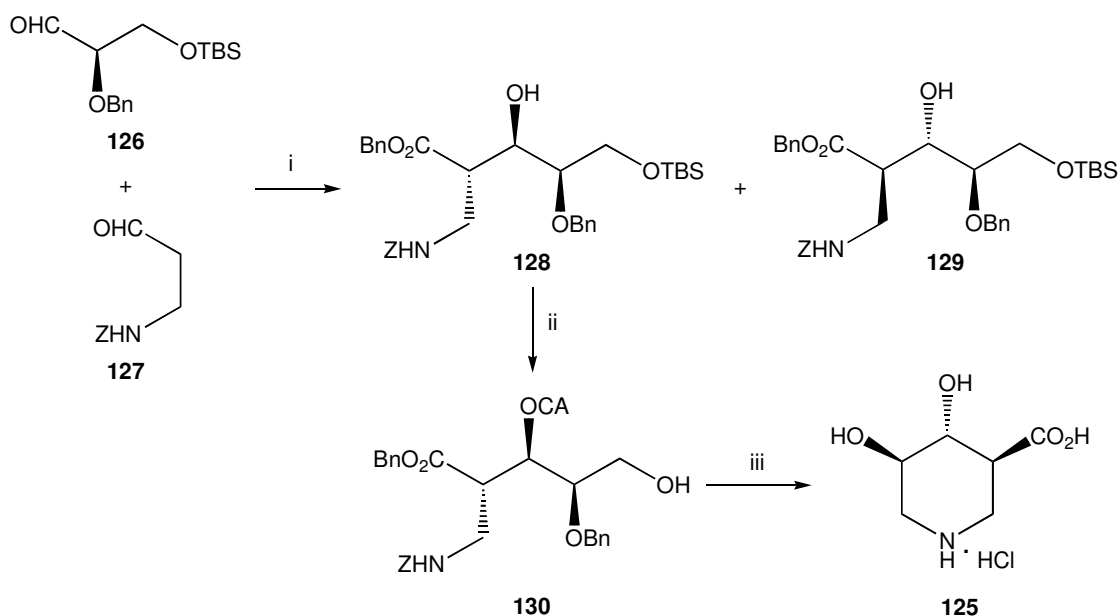

Reagents and conditions: (i) a) proline; b) NaClO₂, NaH₂PO₄, $t\text{-BuOH}$, 2-methyl-2-butene, H_2O , r.t.; c) BnBr, KHCO₃, DMF, r.t., 94%; (ii) a) chloroacetic anhydride, Py, DMAP, CH_2Cl_2 , 91%; b) HF (40%), CH_3CN ; (iii) a) $(\text{COCl})_2$, DMSO, -65°C , CH_2Cl_2 ; b) Et_3SiH , $\text{BF}_3 \cdot \text{Et}_2\text{O}$, CH_2Cl_2 , 71% (3 steps); c) thiourea, 2,6-lutidine, MeOH, 95%; d) H_2 , Pd/C (10%), MeOH then HCl (1 N), 90%.

Scheme 26

Derivative **128** was transformed into derivative **130**, from which sugar imino acid **125** was obtained in four steps, as depicted in Scheme 26.

2.3. Polyhydroxylated derivatives of isonipecotic acid

Polyhydroxylated piperidine-based γ -amino acids can be regarded as hydroxylated derivatives of isonipecotic acid.⁵⁰ The presence of this type of derivative in the literature is limited; in fact, the only hydroxylated derivative of isonipecotic acid reported is the protected amino ester precursor **133**. Amino ester **133** was synthesized from aldehyde **131**, following a synthetic procedure involving a diastereoselective Baylis-Hillman reaction to give **132** which was then followed by ring-closing metathesis and dihydroxylation (Scheme 27).

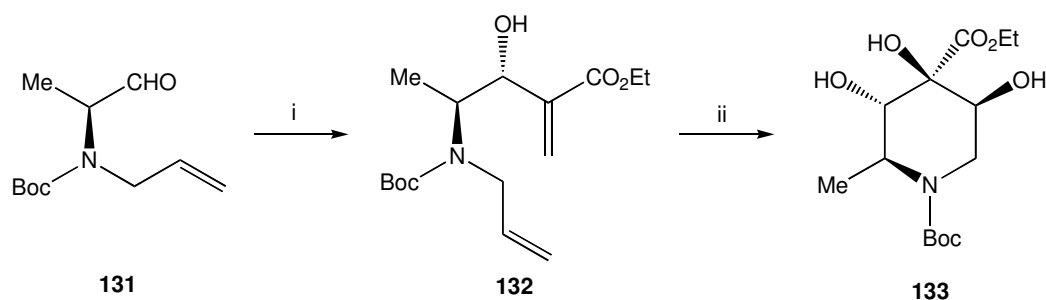

Reagents and conditions: (i) ethyl acrylate, DABCO, sulfolane, r.t.; (ii) a) G-II catalyst, toluene, reflux; b) OsO₄, NMMO (50% aq. sol.), acetone/water (4:1).

Scheme 27

3. Five-membered ring sugar imino acids

As stated in the introduction, in order to discover new peptide-based drugs, many structurally rigid amino acids have been designed. Insertion of these amino acids in peptides is a common approach to restrict the conformational degrees of freedom in small peptides and produces the specific three-dimensional structures required for binding to their receptors.¹

Hydroxylated prolines have been shown to significantly influence polypeptide secondary structure in antibiotics.⁵¹ Moreover the properties of peptides, especially their water solubility, are modified by their degree of hydroxylation.³

Also, L-proline and derivatives have shown to be efficient organocatalysts in asymmetric aldol reactions.⁵² All these observations have stimulated the synthesis of several polyhydroxylated proline derivatives.

The synthesis of different sugar azafuranose α -imino acid derivatives related to proline is described here. There are many syntheses of dihydroxyprolines in the literature⁵³ and although dihydroxyprolines could be regarded as derivatives of erythrose and threose, their study is excluded from this revision.

3.1. Bulgecinine

The bulgecins A (**134**), B (**135**) and C (**136**) (Figure 1) are a group of potent β -lactam synergists isolated from *Pseudomonas acidophila* and *P. mesoacidophila*.⁵⁴ These natural products do not show antibacterial activity by themselves, but increase the sensitivity of the organism to inhibition and, as a result, bacteria are killed at lower β -lactam concentrations. As a consequence of their biological effects and structural novelty, the bulgecins have been the subject of extensive investigations. Accordingly, the bulgecin

aglycon bulgecinine **137**, a proline-like sugar imino acid, has been a target of many research groups and has been synthesized from different sources, mainly from carbohydrates and amino acids.

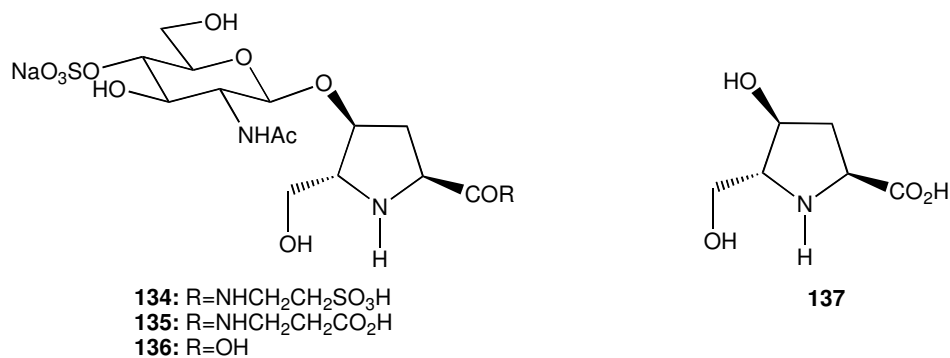
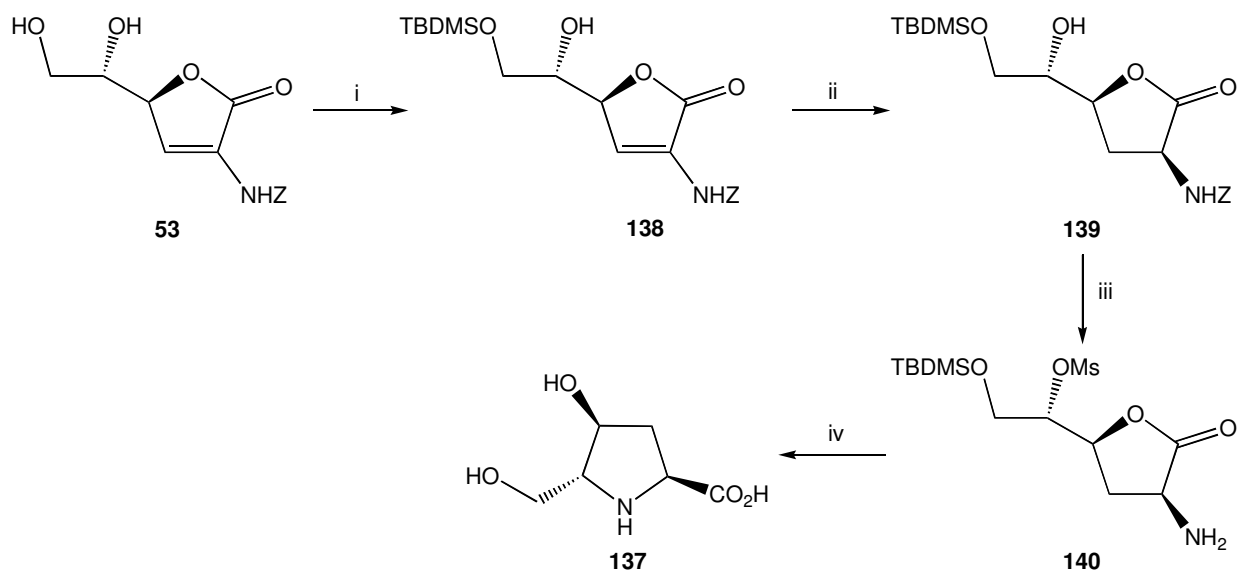

Figure 1

For example, Fleet and coworkers synthesized bulgecinine **137** from unsaturated diol **53**, obtained from glucurono-6,3-lactone **1** as stated in Scheme 12. The sequence involves selective protection of the primary hydroxyl group, esterification of hydroxyl in C-5 with mesyl chloride and catalytic hydrogenation, followed by subsequent intramolecular cyclization (Scheme 28).^{14a,b}



Reagents and conditions: (i) TBDMSCl, Et₃N, DMAP, DMF, CH₂Cl₂; (ii) a) H₂, Pd black, EtOAc, Py; b) Z-Cl, HNaCO₃, EtOAc, H₂O; (iii) a) MsCl, DMAP, Py; b) H₂, 10 % Pd/C, EtOAc/EtOH; (iv) a) HNaCO₃, EtOH/H₂O; b) 2M HCl, THF.

Scheme 28

In 1985, a synthesis of bulgecinine **137** from D-glucose was described.⁵⁵ Thus, D-glucose-derived alcohol **141** was easily transformed into 2-amino lactone **142**. Deprotection of the anomeric position, followed by oxidation, afforded lactone **143**. Lactone **143** was transformed into derivative **144**, from which bulgecinine was obtained in four steps (Scheme 29).

Bulgecinine was also prepared from the amino acid (2*S*,4*R*)-4-hydroxyproline **145**.⁵⁶ The synthetic route includes as the most salient steps the regioselective electrochemical methoxylation of the 4-acetoxypyrrolidine carbamate **146** and a stereospecific free radical substitution reaction on selenide **147** to incorporate the methyl acrylate in **148**. The transformation methyl acrylate moiety into the C-5 hydroxy-methyl group

afforded **149**, which, on basic hydrolysis followed by treatment with fluoride, afforded bulgecinine **147** (Scheme 30).

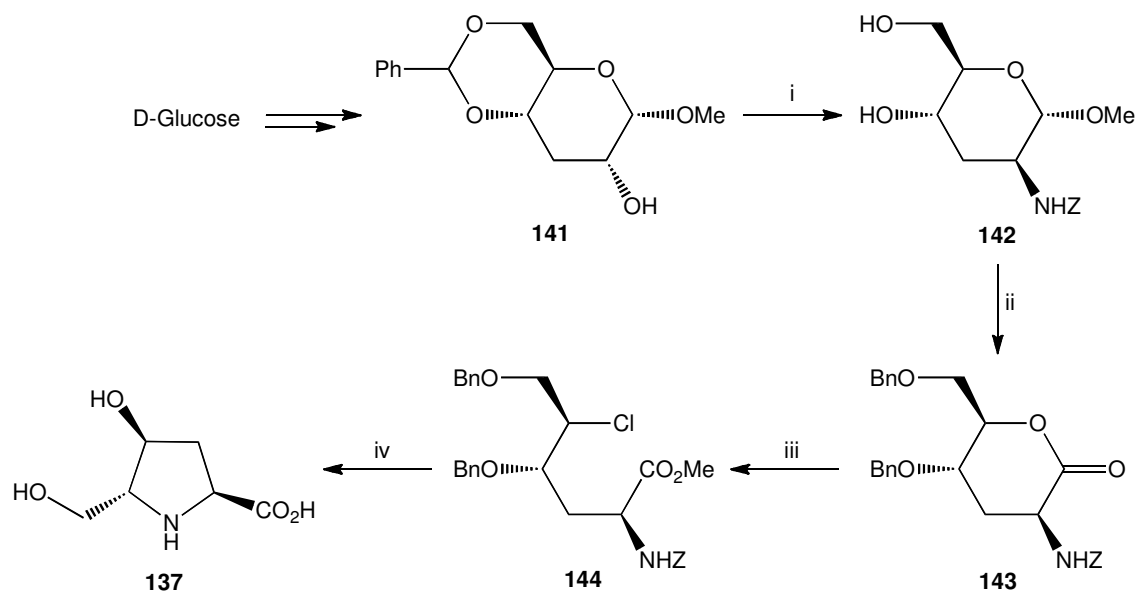

Reagents and conditions: (i) a) CITs, Py, 88%; b) NaN₃, DMF, 73%; c) H₂, Pd black, MeOH, aq. HCl; d) *N*-benzyloxycarbonylsuccinimide, Et₃N, MeOH, 92%; (ii) a) BnBr, NaOH, DMF, 61%; b) conc. HCl, AcOH, 66%; c) PDC, CH₂Cl₂, 59%; (iii) a) MeOH, reflux, quantitative; b) PPh₃, CCl₄, 43%; (iv) a) H₂, Pd black, MeOH, HCl; b) saturated aq. Ba(OH)₂, 75%.

Scheme 29

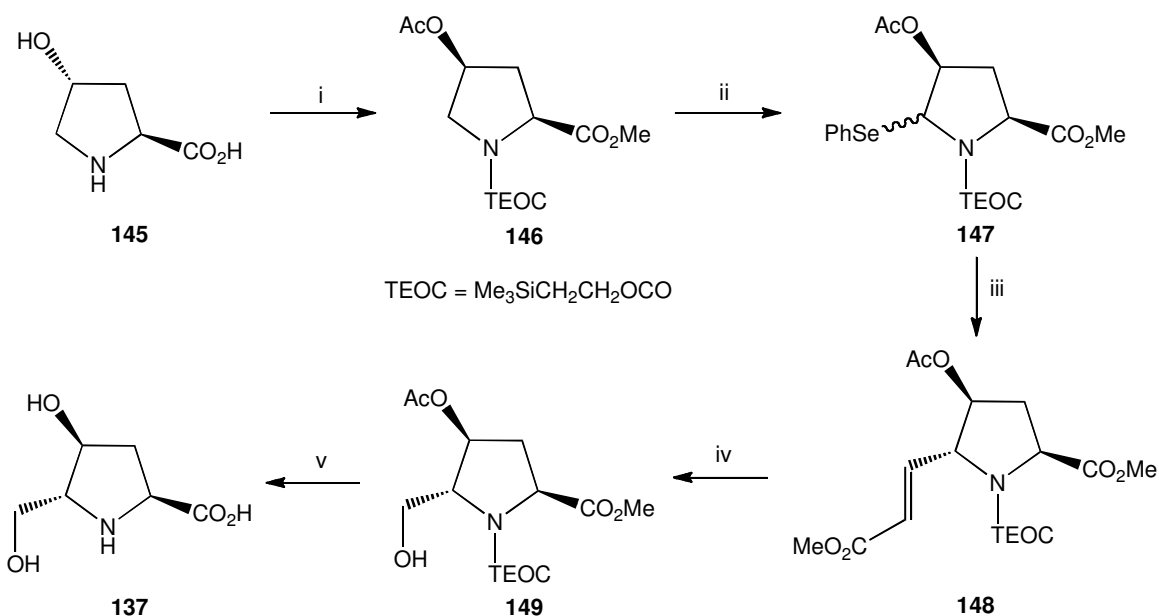

Reagents and conditions: (i) a) MeOH/SOCl₂, 100%; b) TEOC-N₃, Et₃N, CH₃CN, 90%; c) PPh₃, EtO₂CN=NCO₂Et, AcOH, THF, 65%; (ii) a) Et₄NOTs, MeOH, graphite electrodes, 5.5 F mol⁻¹, then Ac₂O, Et₃N, CH₂Cl₂, 64%; b) Ac₂O, AcOH, H₂SO₄ (cat.), 77%; c) PhSeH, TsOH (cat.), 86%; (iii) (*E*)- or (*Z*)-MeO₂CCH=CHSn(Bu)₃, (Bu₃Sn)₂, 250W sunlamp, Pyrex filter, 67%; (iv) O₃, MeOH/CH₂Cl₂; NaBH₄, 83%; (v) NaOH, MeOH, then TBAF, 50%.

Scheme 30

Bulgecinine can also be prepared from the protected derivative of inexpensive (*S*)-pyroglutamic acid **150**.⁵⁷ Thus, regio- and diastereoselective hydroxylation of the monoenolate derived from **150** afforded the optically active pure 4*S*-hydroxypyroglutamate **151**. After a Mitsunobu reaction with benzyl alcohol,

opening of the lactam ring with vinylmagnesium bromide afforded **152**, which, upon mesylation and intramolecular amination, gave **153**. Ozonolysis of the alkene **153** yielded **154**, from which bulgecinine **137** was prepared in two steps (Scheme 31).

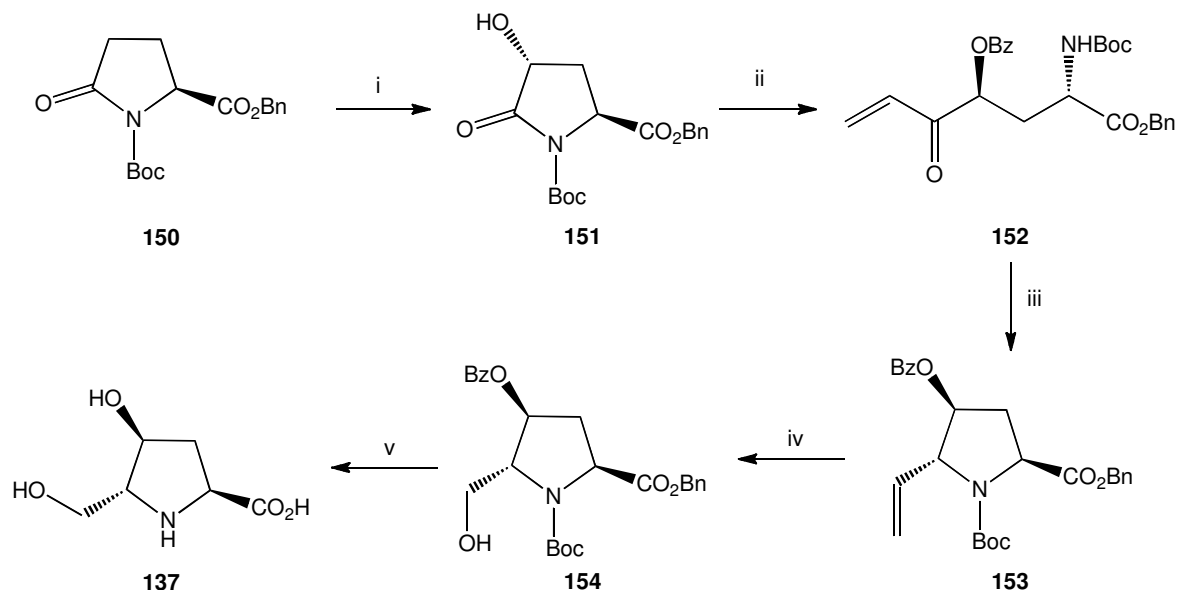

Reagents and conditions: (i) a) $\text{LiN}(\text{Me}_3\text{Si})_2$; b) 2-toluenesulfonyl-3-phenyloxazolidine, -78°C , THF, 61%; (ii) a) BnOH , DEAD, PPh_3 , THF; b) $\text{CH}_2=\text{CHMgBr}$, THF, 40°C , 80%; (iii) a) NaBH_4 , CeCl_3 , MeOH; b) MsCl , Et_3N , CH_2Cl_2 , 0°C ; (iv) O_3 , MeOH, -78°C then NaBH_4 , 99%; (v) a) 1N NaOH , MeOH; b) TFA, PhOMe, 0°C , 57%.

Scheme 31

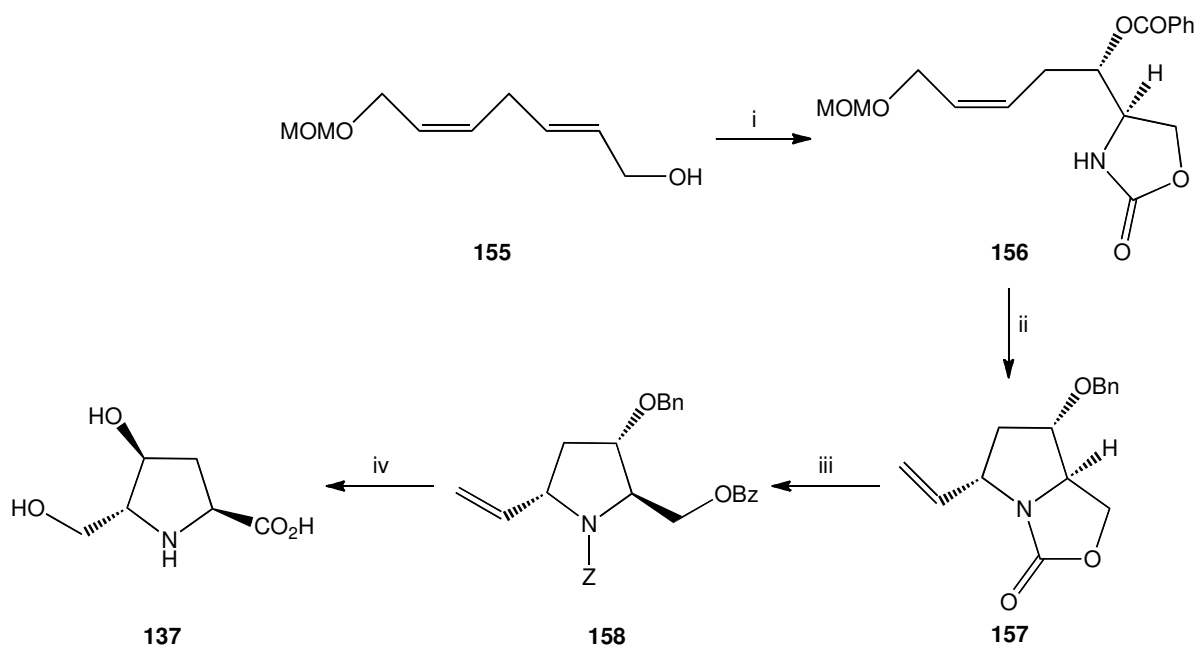

Reagents and conditions: (i) a) L-DIPT, $\text{Ti}(i\text{-PrO})_4$, TBHP, -23°C , 57%; b) benzoyl isocyanate, oxalyl chloride; c) K_2CO_3 , CH_3CN , 93% two steps; (ii) a) 30% $\text{PdCl}_2(\text{MeCN})_2$, THF, r.t., 85%; b) 1N KOH , MeOH, 86%; c) BrBn , NaH , 96%; (iii) a) 1N KOH , MeOH, reflux, 100%; b) Z-Cl , HNaCO_3 , H_2O , CH_2Cl_2 , 90%; c) BzCl , Py, THF, 97%; (iv) a) O_3 , SMe_2 , 99%; b) KMnO_4 , $t\text{-BuOH}$, 80%; c) H_2 , Pd/C , 81%; d) 5N HCl , MeOH, reflux, 64%.

Scheme 32

In 1992, bulgecinine was prepared from allylic alcohol **155** via a pyrrolido[1,2-c]oxazolidin-3-one system.⁵⁸ The transformation starts with an asymmetric epoxidation of allylic alcohol **155**, reaction with

benzoyl isocyanate and base-induced cyclization to give derivative **156**. A Pd-catalyzed N \rightarrow π cyclization exclusively produced the *trans*-substituted pyrrolidine **157**, which was transformed into derivative **158**. Bulgecinine **137** was obtained from **158** in four steps (Scheme 32).

In a complete synthesis of castanospermine, Zhou *et al.* reported in 1993 the determination of the total configuration of epimeric intermediates by means of their degradation to bulgecinine epimers.⁵⁹

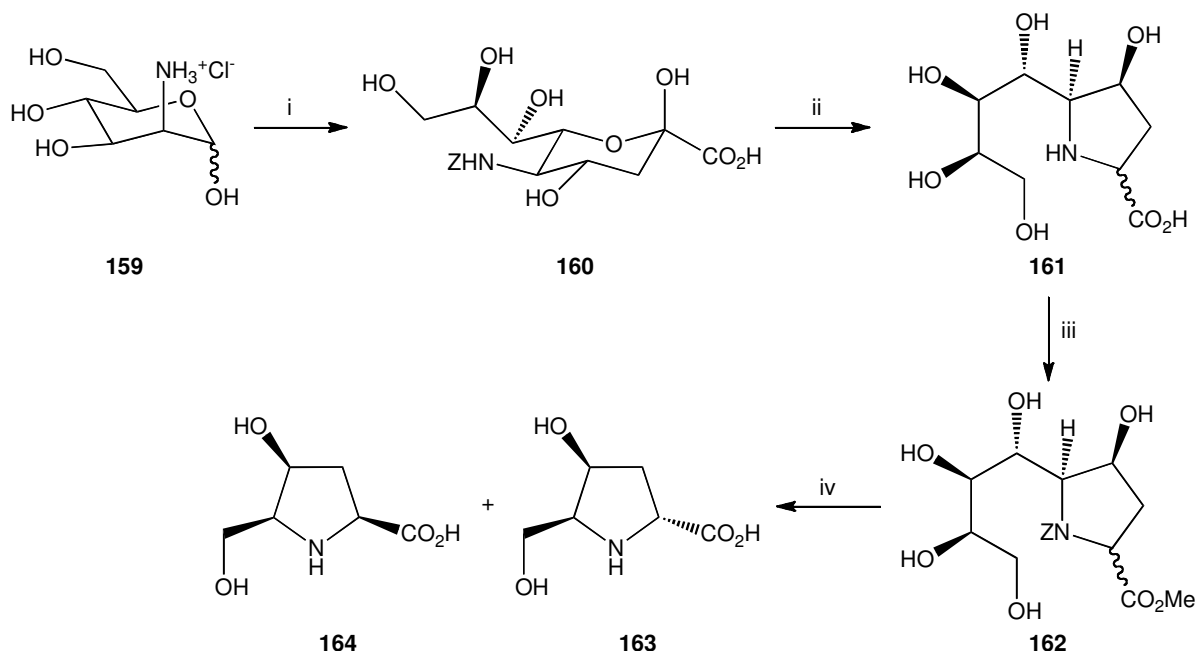

Reagents and conditions: (i) a) Z-Cl/NaHCO₃, H₂O, 86%; b) 10 eq. pyruvate, NANA, pH 7.0; (ii) H₂, Pd/C; (iii) a) Z-Cl, NaHCO₃, H₂O; b) MeOH, HCl; (iv) a) LiOH/H₂O; b) NaIO₄; c) NaBH₄; d) H₂, Pd/C.

Scheme 33

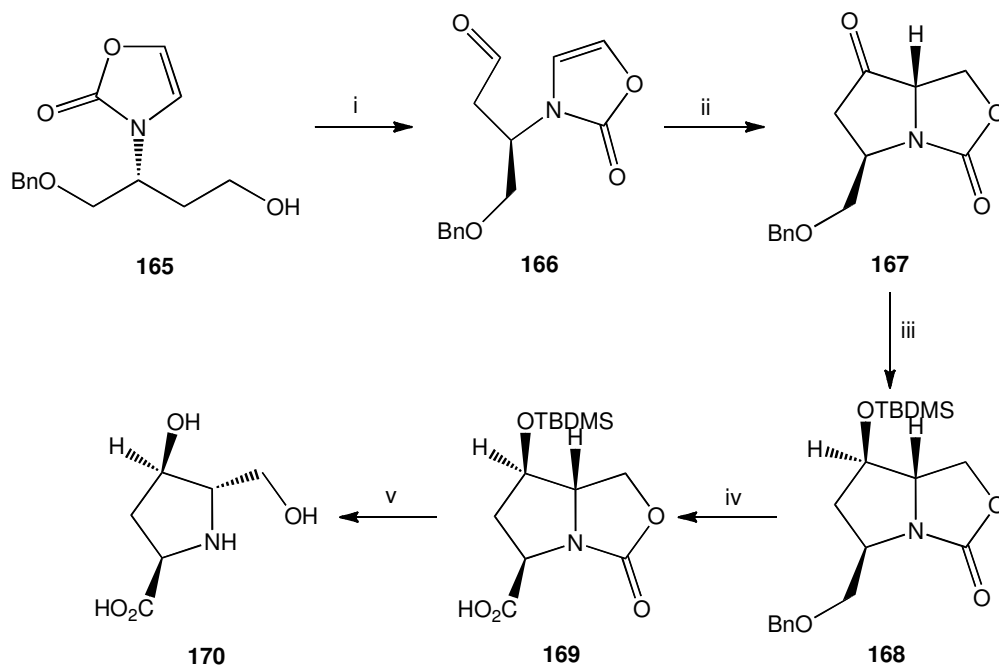

Reagents and conditions: (i) (COCl)₂, DMSO, Et₃N; (ii) a) SnHBu₃, AIBN, benzene; b) (COCl)₂, DMSO, Et₃N; (iii) a) NaBH₄, MeOH; b) TBDMSCl, imidazole, DMF; (iv) a) 10% Pd-C, MeOH; b) RuCl₃·3H₂O, NaIO₄; (v) 10% NaOH, EtOH.

Scheme 34

An enzymatic reaction with *N*-acetylneuraminic acid aldolase (NANA) was used for the transformation of D-mannosamine **159** into neuraminic acid **160**, which was easily transformed into epimeric mixture **162**. Degradation of these epimers afforded bulgecinine isomers **163** and **164** (Scheme 33).

A radical approach towards production of (+)-bulgecinine **170**, the enantiomer of natural (–)-bulgecinine **137**, was reported in 1994. Starting from alcohol **165**, oxidation afforded aldehyde **166**, which upon radical cyclization and oxidation yielded ketone **167**.⁶⁰ Reduction of the ketone and protection of the free hydroxyl group afforded **168**. Hydrogenation and oxidation of the resulting hydroxymethyl group gave carboxylic acid **169** from which (+)-bulgecinine **170** was easily acquired after basic treatment (Scheme 34).

In 1994, (+)-bulgecinine was synthesized *via* the aldol reaction of an optically active chromium aminocarbene complex and subsequent photolysis of the aldol product. Thus, the chromium (dibenzylamino) methylcarbene complex **171** underwent an aldol reaction with 2,3-*O*-isopropylidene-D-glyceraldehyde, producing a 1:1 mixture of diastereoisomers of the carbene complex **172** with an excellent yield. Photolysis of this mixture gave a separable 1:1 mixture of amino lactones **173** and **174**. Compound **173** was converted to derivative **174**, from which (+)-bulgecinine **170** was obtained in five steps (Scheme 35).⁶¹

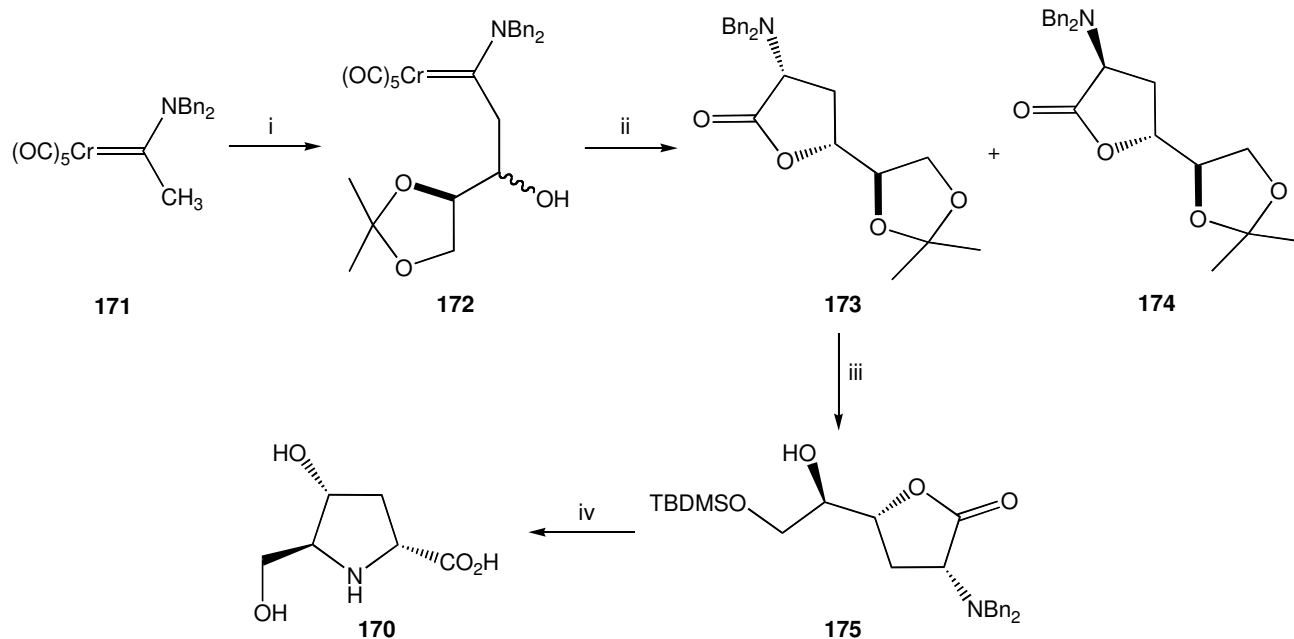

Reagents and conditions: (i) a) BuLi; b) 2,3-*O*-isopropylidene-D-glyceraldehyde, 87% two steps; (ii) a) hv, 79% 1:1; b) chromatographic separation; (iii) a) 1N HCl, CH₂Cl₂/MeOH, 96%; b) TBDMSCl, Et₃N, DMAP, CH₂Cl₂, 82%; c) MsCl, Et₃N, DMAP, 94%; (iv) a) H₂/Pd(OH)₂; b) NaHCO₃/MeOH; c) 5% HCl/THF, 65%.

Scheme 35

In 1997, Fehn *et al.* reported a stereoselective synthesis of (–)-bulgecinine **137** starting from (*S*)-aspartic acid **176**.⁶² After the conversion of **176** into derivative **177**, treatment with N₂CHCO₂Et afforded **178**. The key step was the [Rh(OAc)₂]₂-catalyzed stereospecific transformation (de >98%) of the hexafluoroacetone protected diazoketone **178** into the 4-oxoproline derivative **179**. The keto function of **179** was reduced with high diastereoselectivity (de >88%) to give the 4-*cis*-hydroxyproline derivative **180**. (–)-Bulgecinine **137** was obtained from **180** after deprotection and reduction of the ester moiety (Scheme 36).

The key step in the transformation of the conjugated dienamide ester **181** into (+)-bulgecinine **170** was an extremely efficient catalytic asymmetric hydrogenation to the corresponding γ,δ -unsaturated amino acid

182.⁶³ γ,δ -Unsaturated amino acid **182** was then transformed into derivative **183**, which, after treatment with NBS, afforded lactone **184**. (+)-Bulgecinine **170** was obtained from lactone **184** in two steps (Scheme 37).

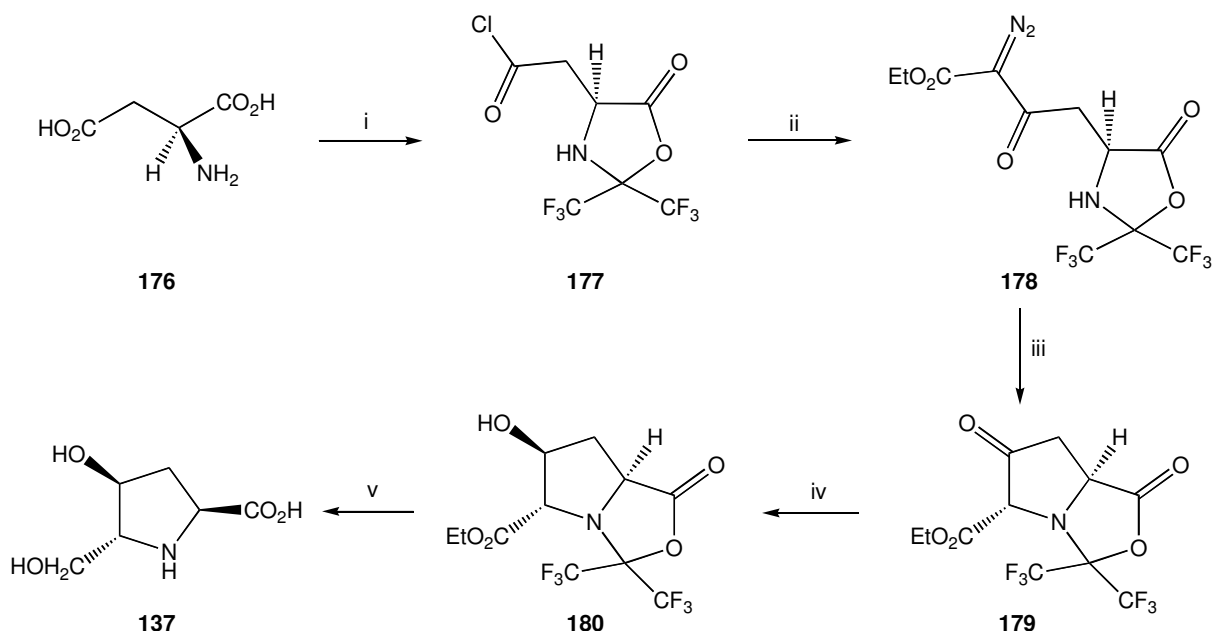

Reagents and conditions: (i) a) $(\text{CF}_3)_2\text{CO}/\text{DMSO}$, 86%; b) SOCl_2 , 84%; (ii) $\text{N}_2\text{CHCO}_2\text{Et}$, 90%; (iii) $[\text{Rh}(\text{OAc})_2]_2$, 94%; (iv) NaBH_3CN , 79%; (v) a) $\text{H}_2\text{O}/i\text{PrOH}$, 92%; b) LiBHET_3 , 44%.

Scheme 36

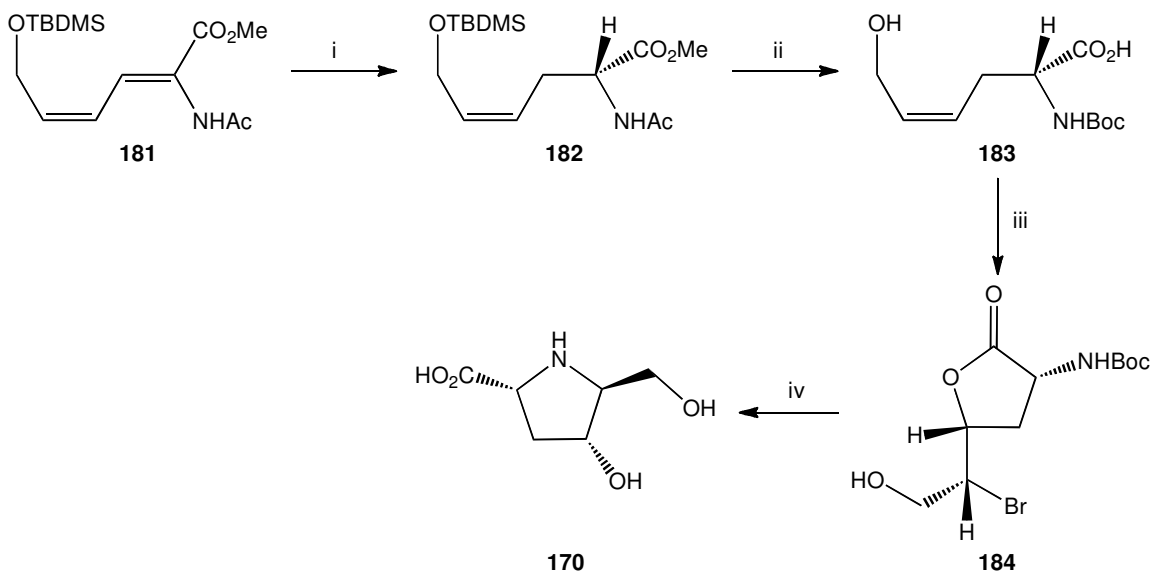

Reagents and conditions: (i) $[(R,R)\text{-Et-DuPHOS-Rh}]\text{OTf}$, S/C=500/1, MeOH, 60 psi of H_2 , 2 h, 99%, (99.3% ee *R*); (ii) a) Boc_2O , DMAP, THF 24 h then N_2H_4 , MeOH/THF (1:1) 4 h, 92%; b) HF-Py , CH_2Cl_2 , 91%; c) 0.5 M LiOH/THF , 4:1, 91%; (iii) NBS, THF, 0 °C, 5 min., 80%; (iv) a) TFA, CH_2Cl_2 , 40 °C, 3 h; b) 0.1 N $\text{Ba}(\text{OH})_2$, r.t., 3 h, 80% for two steps.

Scheme 37

The synthesis of an epimer of natural bulgecinine, namely (2*S*,4*S*,5*R*)-bulgecinine **190**, was accomplished by Barbier reaction of *N*-benzyl-*N*-carbobenzyloxy-*O*-*tert*-butyldimethylsilyl-D-serinal **185** with allyl bromide to afford the *anti*-adduct **186**. Epoxidation and acetylation yielded **187**, which afforded imino compound **188** via intramolecular amination. Oxidation of the hydroxymethyl moiety gave **189**, which was subsequently transformed into the desired imino acid **190** in two steps (Scheme 38).⁶⁴

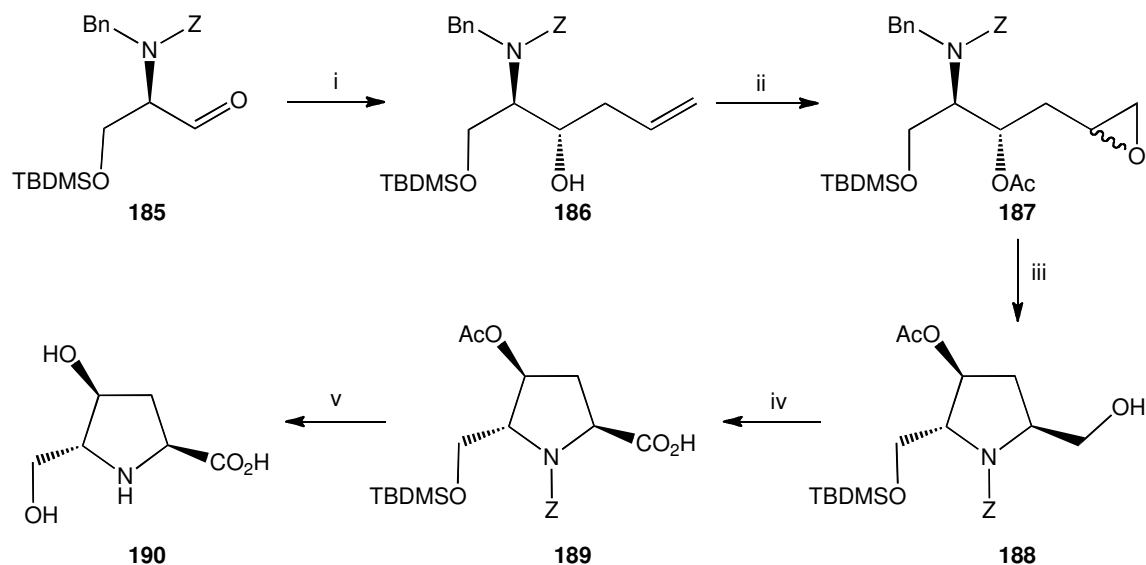

Reagents and conditions: (i) a) $\text{CH}_2=\text{CHCH}_2\text{Br}$, Zn, satd aq. NH_4Cl , THF, r.t., 96%; b) chromatographic separation; (ii) a) $t\text{-C}_4\text{H}_9\text{OOH}$, $\text{VO}(\text{acac})_2$ cat., CH_2Cl_2 , r.t., 79%; b) Ac_2O , Py, DMAP cat., r.t., 90%; (iii) a) H_2 , 5% Pd/C, CH_3OH , r.t.; b) Z-Cl , CH_2Cl_2 , satd aq. NaHCO_3 , r.t., 88% two steps; c) chromatographic separation; (iv) NaIO_4 , RuCl_3 cat., $\text{CH}_3\text{CN}/\text{CCl}_4/\text{H}_2\text{O}$ 2:2:3, 0 °C, 80%; (v) a) 3 M aq. HCl, THF, reflux, 88%; b) H_2 , 5% Pd/C, CH_3OH , r.t., 90%.

Scheme 38

Other efficient synthetic routes to enantiopure bulgecinine **137** used D-serine derivative **191** as a chiral template. Allyl addition to amide **191** afforded ketone **192**, which upon stereoselective reduction gave alcohol **193**. Cleavage of the five-membered acetal ring and formation of a six-membered acetal ring yielded **194**. A highly regio and stereoselective intramolecular amidomercuration-oxidation protocol performed on derivative **194** formed the pyrrolidine ring of compound **195**. Bulgecinine **137** was easily obtained after oxidation of the hydroxymethyl group to the corresponding carboxylic acid and acidic hydrolysis (Scheme 39).⁶⁵

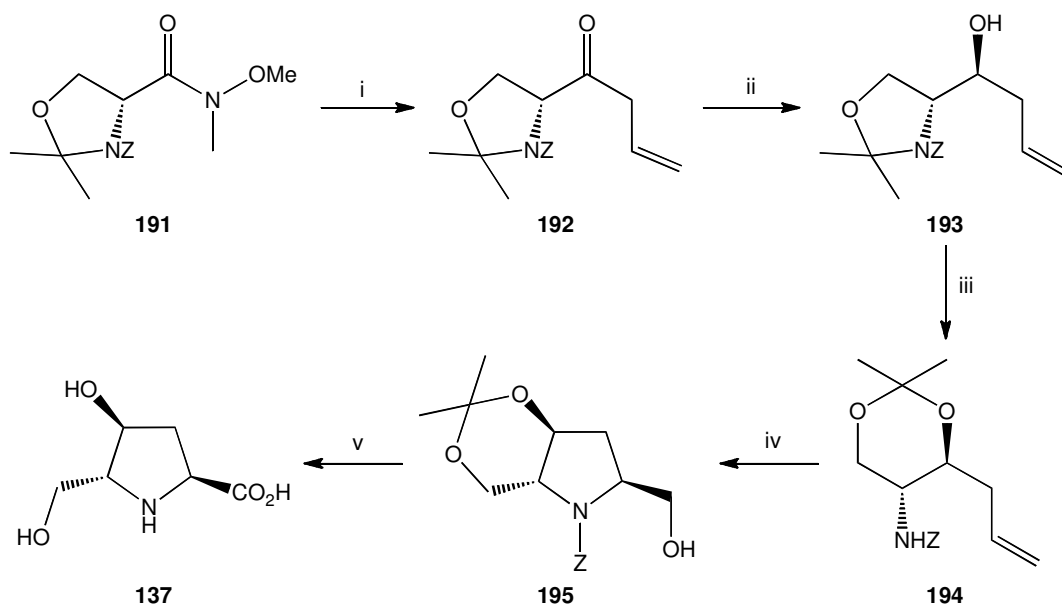

Reagents and conditions: (i) Mg, $\text{CH}_2=\text{CHCH}_2\text{Br}$, -78 °C, quant.; (ii) $\text{Zn}(\text{BH}_4)_2$, Et_2O , $\text{CeCl}_3 \cdot 7\text{H}_2\text{O}$, MeOH, -10 °C, (*anti:syn* > 95:5); (iii) a) $\text{AcOH}/\text{H}_2\text{O}$ (3:1), 92%; b) $\text{Me}_2\text{C}(\text{OMe})_2$, CSA, acetone, 92%; (iv) a) $\text{Hg}(\text{OAc})_2$, MeCN; b) O_2 , NaBH_4 , DMF, r.t., 65%; (v) a) Dess-Martin periodinane then NaClO_2 , NaH_2PO_4 ; b) CH_2N_2 , 71% 3 steps; c) aq. HCl, reflux, 94%.

Scheme 39

Chavan *et al.* described a stereoselective synthesis of natural bulgecinine **137** starting from compound **196**, derived from the readily available non chiral pool starting material *cis*-2-butene-1,4-diol.⁶⁶ As outlined in Scheme 40, the enantiomerically pure hydroxylactone **197** was obtained from **198**, following a procedure in which a Claisen orthoester rearrangement and a Sharpless asymmetric dihydroxylation were used as the key steps to install the requisite chirality. Treatment with NBS afforded 2-bromolactone **199**, which was then easily transformed into carboxylic acid **200**. Catalytic hydrogenation and basic treatment yielded the desired bulgecinine **137**.

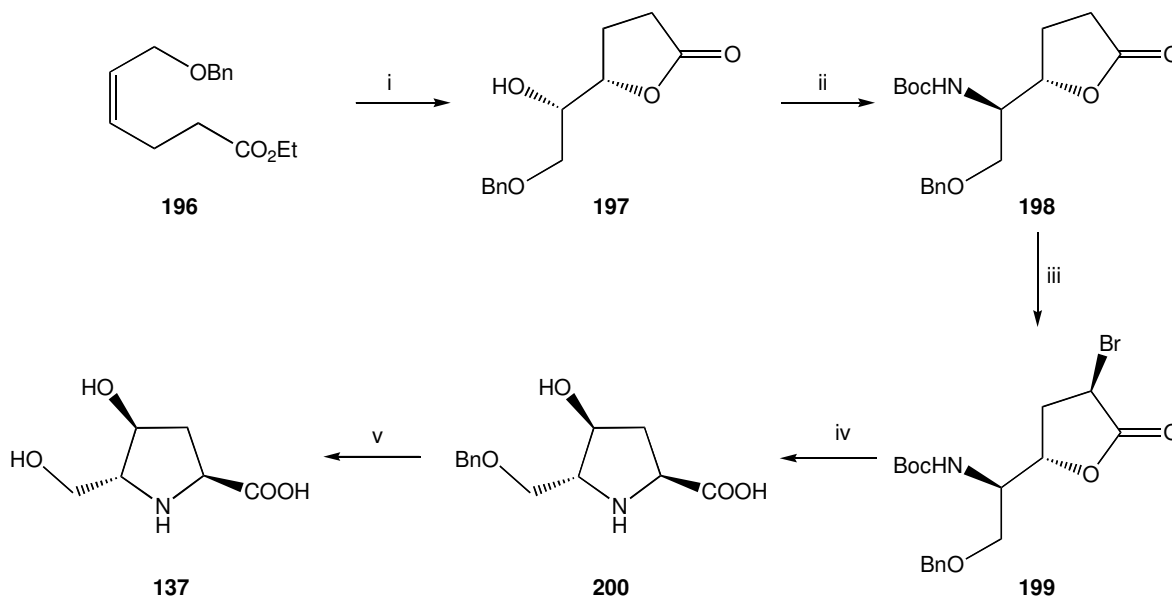

Reagents and conditions: (i) AD-mix- α , $\text{CH}_3\text{SO}_2\text{NH}_2$, *t*-BuOH/ H_2O (1:1), 24 h, 0 °C, 95%, 93% ee; (ii) a) MsCl, Et_3N , DMAP, CH_2Cl_2 , 0 °C, 4 h, 92%; b) NaN_3 , DMF, 90 °C, 24 h, 89%; c) H_2 , 10% Pd-C, Et_3N , Boc_2O , EtOAc, r.t., 2 h, 88%; (iii) LiHMDS, TMSCl, Et_3N , NBS, THF, -78 °C, 2 h, 65%; (iv) a) TFA, CH_2Cl_2 , 60 °C, 3 h; b) 0.1 N $\text{Ba}(\text{OH})_2$, pH=9, 3 h; c) dil HCl, Amberlite-IR-120, 24 h; d) 6 N NH_4OH (aq), 3 h; (v) a) 10% Pd-C, methanolic HCl, r.t., 24 h; b) 1 M NaOH, r.t., 92% (over three steps).

Scheme 40

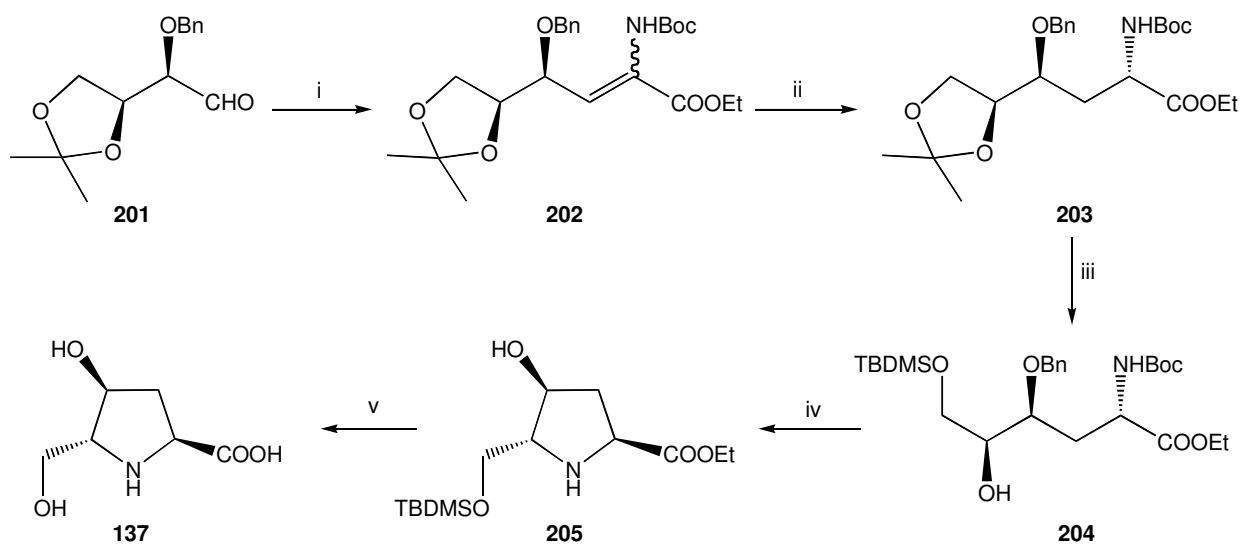

Reagents and conditions: (i) Boc-Gly-OEt, $\text{KO}^t\text{-Bu}$, CH_2Cl_2 , -70 °C, 5 h, 82%; (ii) a) 10% Pd/C, H_2 , Na_2CO_3 , EtOAc, 3 h, 74%; b) separation; (iii) a) PPTS, EtOH, 55 °C, 24 h, 80%; b) TBDMSCl, imidazole, CH_2Cl_2 , 6 h, 96%; (iv) a) MsCl, DIPEA, 2 h; b) 15% TFA in CH_2Cl_2 , 3 h then NaHCO_3 , overnight, 63% (two steps); c) 10% Pd/C, H_2 , EtOH, overnight, 90%; (v) 6 M HCl, 100 °C, 5 h, 85%.

Scheme 41

In 2006, Chandrasekhar *et al.* reported a practical synthesis of natural (–)-bulgecinine **137** from aldehyde **201**, derived from commercially available L-ascorbic acid.⁶⁷ Aldehyde **201** was subjected to a Wittig-Horner reaction to obtain **202**. Hydrogenation of compound **202** afforded a mixture from which aminoester **203** was separated and transformed into aminoester **204**. Aminoester **204** was then treated with mesyl chloride to give, after acidic hydrolysis, subsequent intramolecular amination and catalytic hydrogenation, cyclic amino ester **205**. (–)-Bulgecinine **137** was easily obtained from **205** after acidic hydrolysis (Scheme 41).

2,5-Dihydropyrrole intermediate **207**, prepared by means of a ring closing metathesis of derivative **206**, was the intermediate in a short and high yielding asymmetric synthesis of (–)-bulgecinine. Hydroboration-oxidation of **207** produced **208**, which was easily transformed into derivative **209**. Oxidation of the hydroxymethyl group in **209**, followed by catalytic hydrogenation, formed bulgecinine **137** (Scheme 42).⁶⁸

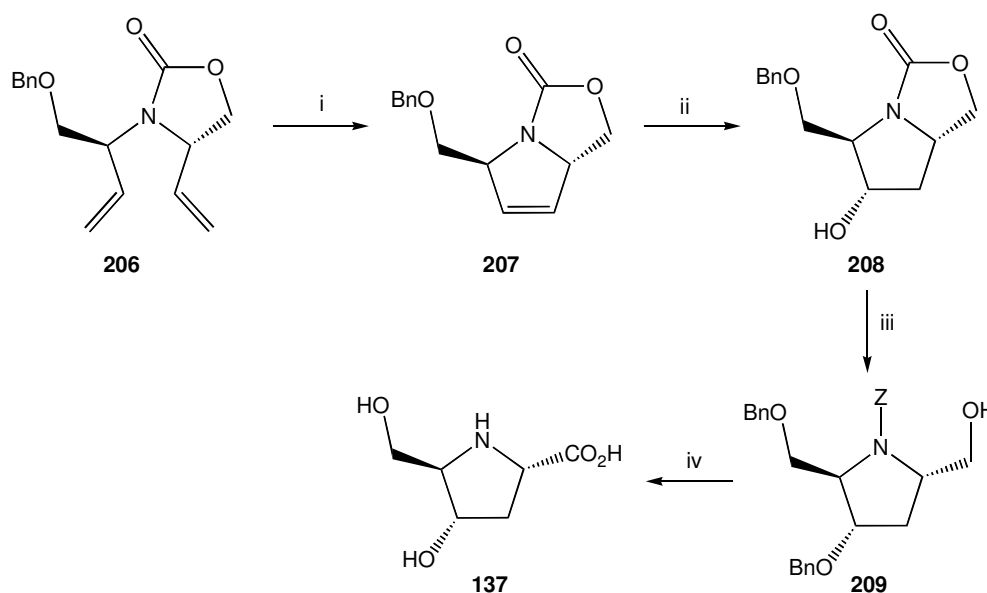

Reagents and conditions: (i) Grubs catalyst, CH₂Cl₂, 40 °C, 91%; (ii) BBN, HBR₂, NaOH, H₂O₂; (iii) a) NaH; BnBr, NBU₄I, THF, 92%; b) NaOH, EtOH/H₂O 3:1, 85 °C; c) Z–Cl, NaHCO₃, H₂O, two steps 85%; (iv) a) TEMPO, NaOCl, KBr, 75%; b) Pd/C, H₂, MeOH, 95%.

Scheme 42

In another instance, starting from commercially available *N*-Boc-D-serine **210**, alkene **211** was prepared. Epoxidation of **211** and subsequent intramolecular amination afforded hydroxypyrrolidine **212** which, after elimination of the hydroxyl group followed by *in situ* addition of cyanide, gave **214**. From **214**, (–)-bulgecinine **137** was obtained after acidic hydrolysis (Scheme 43).⁶⁹

(*S*)-Pyroglutaminol **215** was used as a chiral starting material for the efficient and straightforward synthesis of bulgecinine. In this route, oxirane **217** was prepared from **215** and cleaved by treatment with samarium diiodide to produce the secondary alcohol function of compound **218**. Controlled acidic hydrolysis of the oxazolidine ring of **218** with trifluoroacetic acid formed the alcohol **219**. In a similar fashion as in the previous example, a cyano group was diastereoselectively introduced as a precursor of the carboxylic group and, finally, acidic hydrolysis afforded the bulgecinine **137** (Scheme 44).⁷⁰

Chiral inductors are widely employed for the preparation of diverse amino acids.⁷¹ This strategy was also applied to the preparation of bulgecinine, as in the synthesis described by Oppolzer *et al.* in 1994.⁷²

Alkylation of the chiral glycine derivative **221** with activated organohalide **222** under ultrasound-assisted phase-transfer catalysis provides enantiomerically pure alkylation product **223**. Acidic hydrolysis afforded **224**, which on basic treatment followed by Boc protection afforded amino acid **225**. Bromination of **225** with NBS yielded bromolactone **226**, from which bulgecinice **137** was easily obtained after acidic hydrolysis followed by basic treatment.

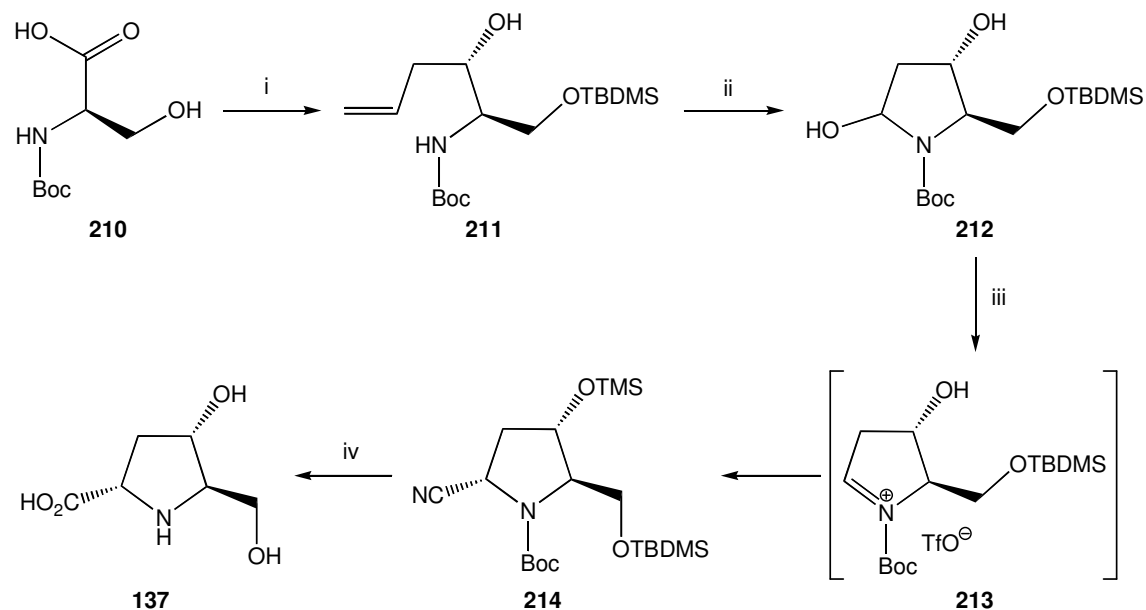

Reagents and conditions: (i) a) TBDMSCl, imidazole, DMF, r.t.; b) *n*-BuLi (1 eq.), THF, $-10\text{ }^{\circ}\text{C}$ then $\text{CH}_2=\text{CHCH}_2\text{MgBr}$, $-78\text{ }^{\circ}\text{C}$ to r.t.; c) NaBH_4 , MeOH, $-78\text{ }^{\circ}\text{C}$, 76%, 3 steps, dr > 95:5; (ii) OsO_4 , NaIO_4 , THF / H_2O ; (iii) TMSOTf, TMSCN, CH_2Cl_2 , $-78\text{ }^{\circ}\text{C}$, 77%, 2 steps, dr=91:9; (iv) 6M HCl, $60\text{ }^{\circ}\text{C}$, then Dowex 50W-X4, 93%.

Scheme 43

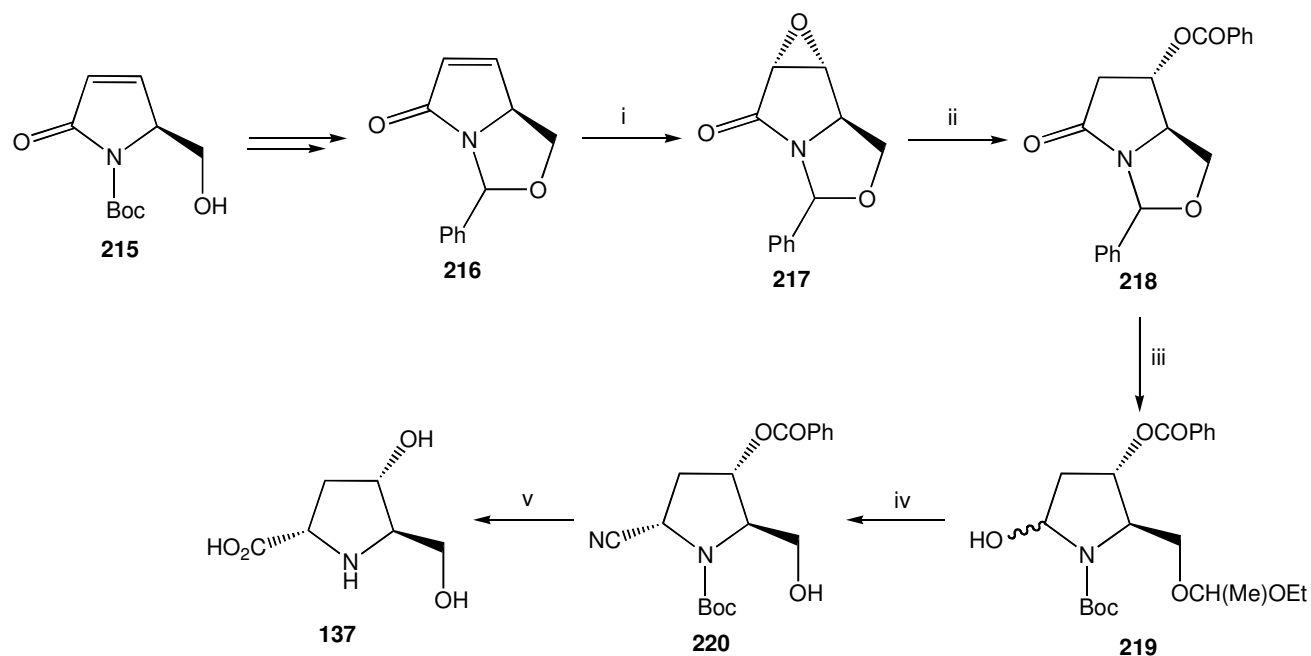

Reagents and conditions: (i) *t*-BuOOH, K_2CO_3 , TBAF, DMF, 75%; (ii) a) SmI_2 , THF, MeOH, 95%; b) PhCOCl , CH_2Cl_2 , Et_3N , 100%; (iii) a) TFA, THF, H_2O , 91%; b) $\text{CH}_2=\text{CHOEt}$, H^+ , 89%; c) Boc_2O , DMAP, 100%; d) DIBAL-H, hexane, THF, 95%; e) MeOH, H^+ , 89%; (iv) Me_3SiCN , SnCl_4 , CH_2Cl_2 , 50%; (v) HCl, 100%.

Scheme 44

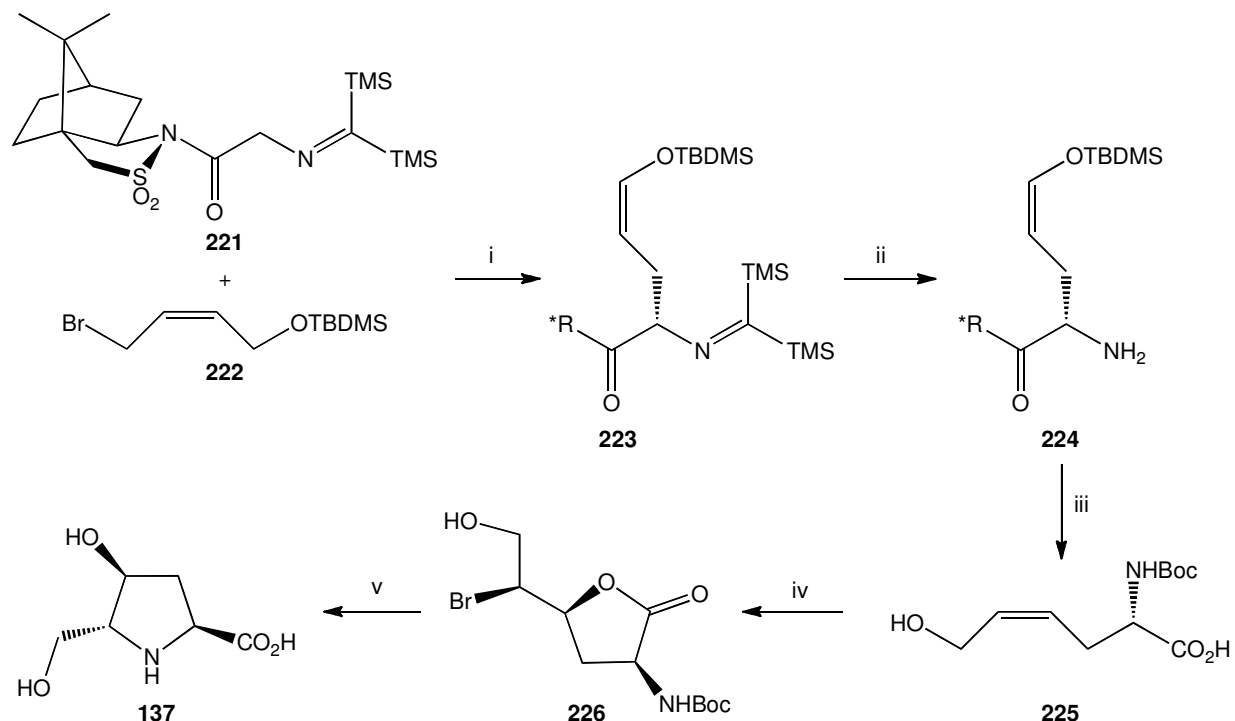

Reagents and conditions: (i) LiOH, CH₂Cl₂, (Bu₄N)HSO₄, ultrasound; (ii) 0.5 N aq. HCl, THF; (iii) a) LiOH, aq. THF; b) ion exchange; c) Boc₂O, HNaCO₃, EtOAc (iv) NBS; (v) a) TFA, H₂O; b) aq. Ba(OH)₂.

Scheme 45

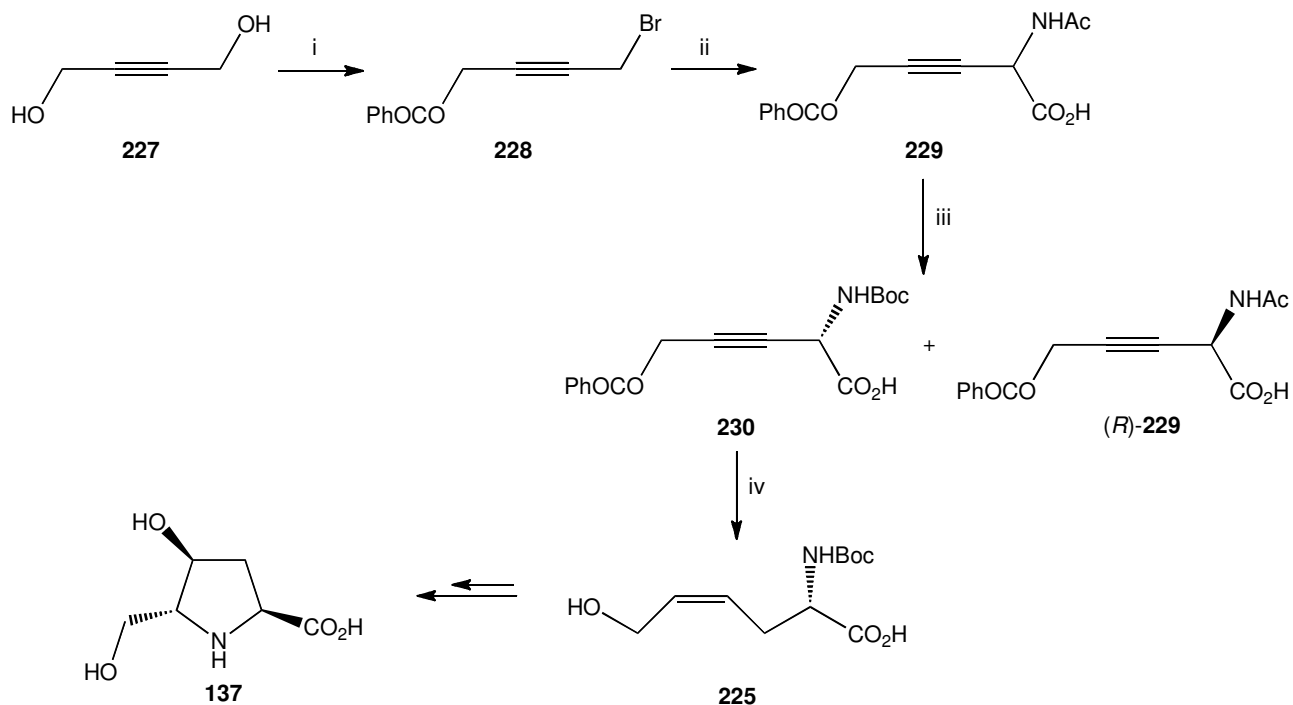

Reagents and conditions: (i) a) PhCOCl, Py, CH₂Cl₂; b) TEA, DMAP, MsCl, CH₂Cl₂, 2 h; c) LiBr, acetone, 1.5 h; (ii) a) diethyl acetamidomalonate, KO^t-Bu, THF, reflux, 22 h; b) NaOH, MeOH, reflux, 3.5 h, then conc. HCl, reflux, 22 h; (iii) L-acylase (200 U/g substrate), 30 mM KH₂PO₄, pH 7, 2.5 h, then Boc₂O, THF, 5 M NaOH to maintain pH at 10, r.t., 3.5 h; (iv) H₂, 10% wt. Lindlar catalyst, MeOH, 1.5 h.

Scheme 46

In 2005, an enzymatic approach to natural (–)-bulgecinine **137** was described.⁷³ Starting from cheap 2-butyn-1,4-diol **227**, formation of the monobenzoate followed by derivatization to the mesylate and

bromination afforded bromide **228** (Scheme 46). Condensation of the bromide **228** with the diethyl acetamidomalonate anion gave the corresponding diester, which was hydrolyzed and then decarboxylated to produce the racemic *N*-acetyl acid **229**. Treatment of **229** with extremophilic L-acylase gave a mixture of (*S*)-amino acid **230** and unreacted (*R*)-*N*-acetyl acid **229**. Lindlar hydrogenation of **230** formed the desired *cis*-allylic alcohol **225**, which was transformed into bulgecinine **137** as previously described in Scheme 45.

3.2. Trihydroxyproline derivatives

The first azafuranose-type imino acid derivative reported in the literature was the protected amino ester **235**, a precursor of the corresponding amino acid, which was an intermediate in a synthesis of a galactofuranose pyrrolidine analogue.⁷⁴ Azidolactone **232**, easily obtained from commercial **231**, was transformed into azidolactone **233**. Treatment with triflic anhydride yielded triflate **234**, which after catalytic hydrogenation and treatment with sodium acetate in methanol, afforded the methyl ester **235** (Scheme 47).

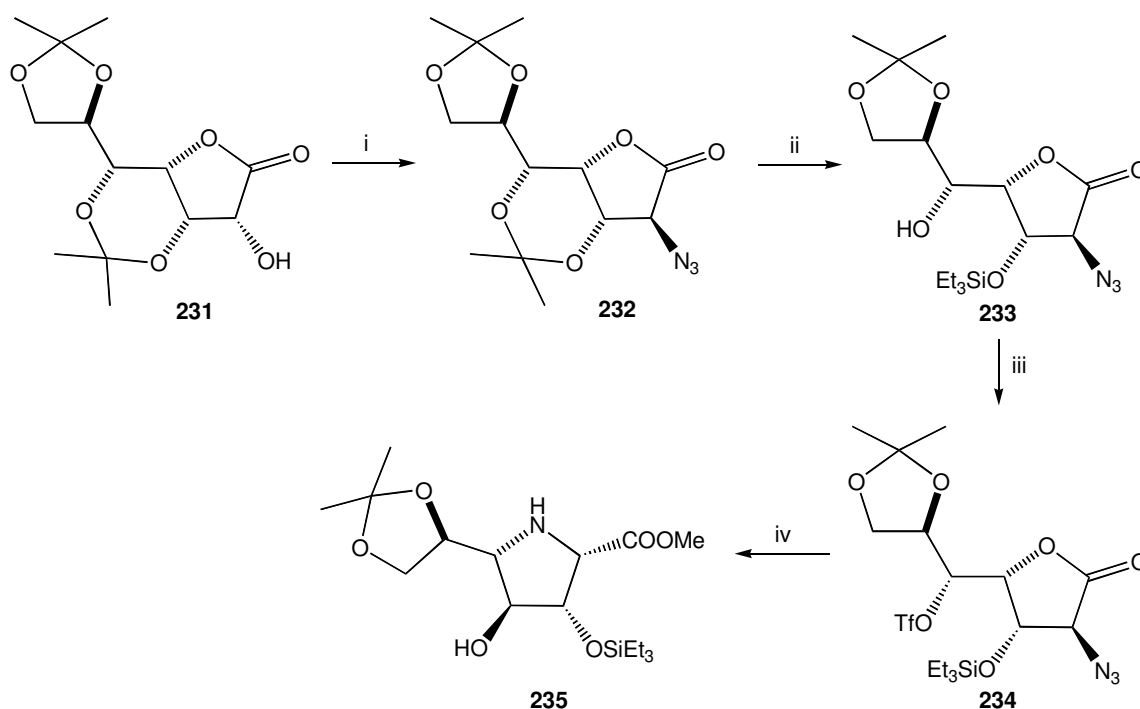

Reagents and conditions (i) Tf_2O , CH_2Cl_2 , pyridine, $-20\text{ }^\circ\text{C}$; then NaN_3 , DMF; (ii) a) $\text{TFA}/\text{H}_2\text{O}$, 1:1; then $\text{Me}_2\text{C}(\text{OMe})_2$, Me_2CO , CSA; b) Et_3SiCl , imidazole, DMF; (iii) Tf_2O , CH_2Cl_2 , pyridine; (iv) a) H_2 , Pd black, EtOAc ; b) NaOAc , MeOH .

Scheme 47

Later in 2004, imino ester **239** was obtained as an intermediate in the total synthesis of 1-epiaustraline.⁷⁵ The procedure uses a diastereoselective Birch reduction of the electron-deficient pyrrole **236** to give **237** and an OsO_4 -catalyzed dihydroxylation of **237** to yield, after acetonation, protected diol **238**. The selective reduction of one of the ester groups in the diester **238** finally afforded **239** (Scheme 48).

5-Hydroxymethyl-3,4-isopropylidenedioxyproline **246** was prepared from the Diels-Alder adduct of *N*-(*tert*-butoxycarbonyl)pyrrole **240** and 2-bromo-1-(*p* toluenesulfonyl)acetylene **241**.⁷⁶ Thus, reduction of adduct **242** followed by Swern oxidation of the resulting alcohol **243**, afforded 7-azabicyclo[2.2.1]hept-2-one **244**. Formation of silyl enol ether to give **245**, followed by ozonolysis, reduction and acidic hydrolysis, produced the desired imino acid **246** (Scheme 49).

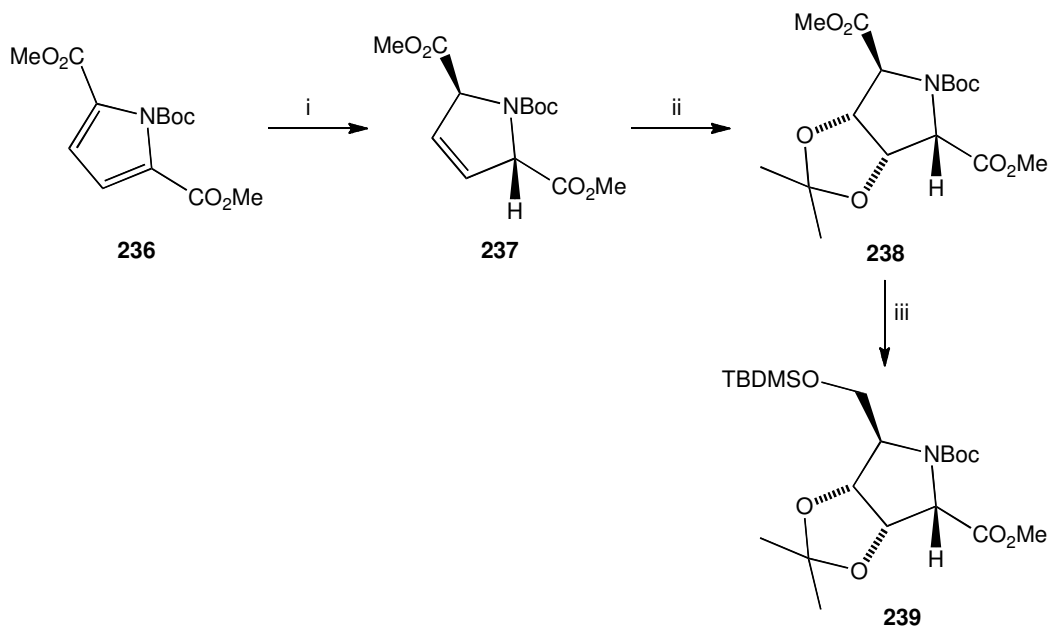

Reagents and conditions: (i) Li, NH₃/THF, NH₄Cl, -78 °C, 73%; (ii) cat. OsO₄, CH₂Cl₂, Me₃NO, 95%; (iii) dimethoxypropane, cat. *p*-TsOH, acetone, 94%; (iv) a) NaBH₄, THF/MeOH; b) TBDMSCl, imidazole, DMF, 85% two steps.

Scheme 48

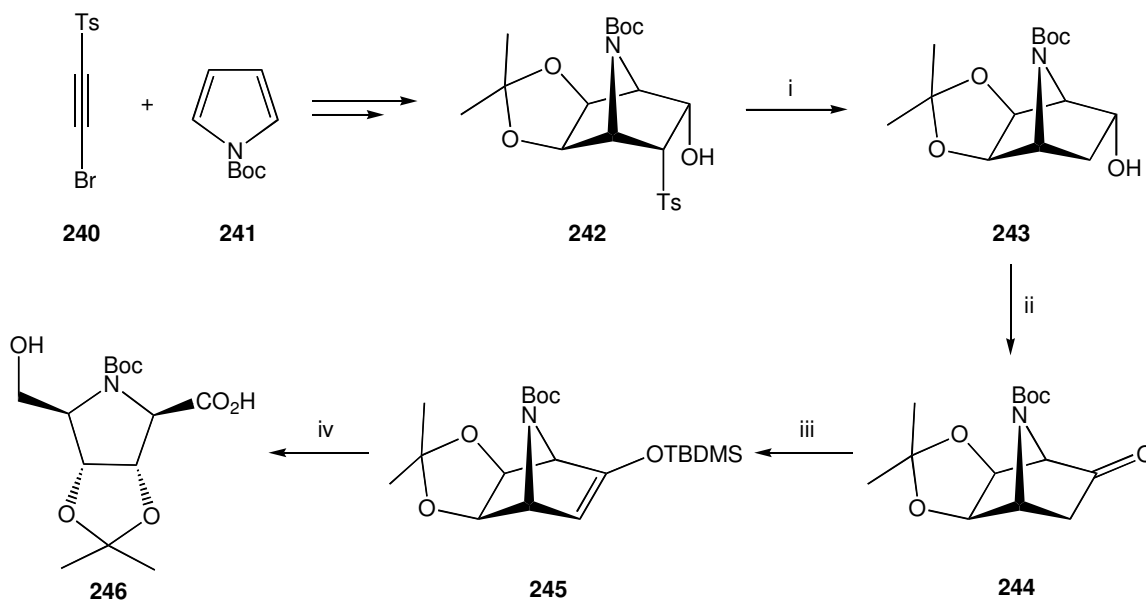

Reagents and conditions: (i) Na-Hg (5%), MeOH, THF, -15 °C, 75%; (ii) "Swern oxidation", 91%; (iii) CF₃CON(Me)TBDMS, Et₃N, DMF, 60 °C, 2 h, 86%; (iv) a) O₃, CH₂Cl₂, MeOH; b) NaBH₄, 88% two steps.

Scheme 49

Protected sugar imino ester **251**, a precursor of the corresponding amino acid, has been synthesized *via* the tin(II)-mediated anti-selective aldol reaction of bislactim ether **247** and a 3-*O*-silylated 2,4-ethylidene-D-erythrose derivative **248**. The resulting compound **249** was treated with anionic fluoride, followed by mesylation and benzylation, to yield the mesylate **250** which, after acidic hydrolysis, afforded imino sugar **251** (Scheme 50).⁷⁷

In 2009, the synthesis of polyhydroxylated aza-furano imino acid **255** was presented.⁷⁸ Starting from aldofuranose **252**, Strecker conditions followed by TMSCN addition gave α -aminonitrile **253**. Cyclization

afforded **254**, which after hydrolysis of the cyano functionality and removal of the protecting groups, yielded sugar imino acid **255** (Scheme 51).

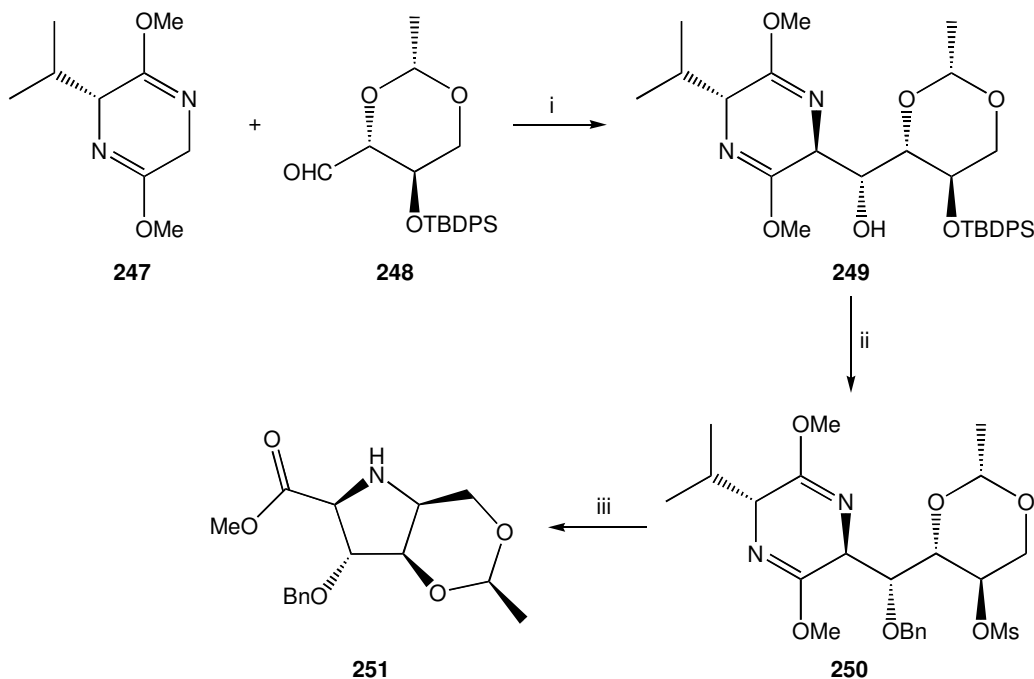

Reagents and conditions: (i) a) *n*-BuLi, THF, $-78\text{ }^{\circ}\text{C}$; b) SnCl_2 , THF, $-78\text{ }^{\circ}\text{C}$, 80%; (ii) a) TBAF, THF, r.t.; b) MsCl, Py, 78% two steps; c) NaH, BnBr, NBu_4I , THF, 70%; (iii) 0.25 M HCl, MeOH, 1:3, 82%.

Scheme 50

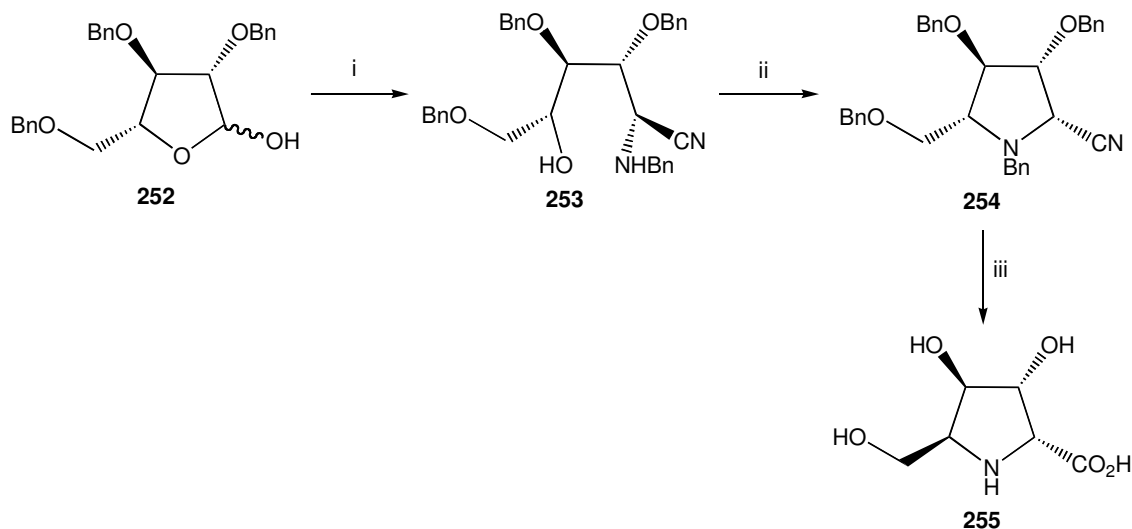

Reagents and conditions: (i) a) $\text{Ti}(\text{O}i\text{Pr})_4$, MeOH, $\text{HCOO}^-\text{NH}_3\text{Bn}^+$; b) TMSCN ; (ii) MsCl, pyridine, $80\text{ }^{\circ}\text{C}$, 57%; (iii) a) 37% aq. HCl, $100\text{ }^{\circ}\text{C}$; b) H_2 , Pd/C; c) Dowex 50W X8.

Scheme 51

Lactone **257**, easily obtained from D-glucose derived azide **256**, was used as the starting material in a practical large-scale synthesis of (3*R*)-3-hydroxy-L-bulgecinine **255**, as depicted in Scheme 52.⁷⁹ Treatment of **257** with triflic anhydride afforded the corresponding triflate **258**, which on catalytic hydrogenation yielded imino acid **260** via bicyclic lactone **259**.

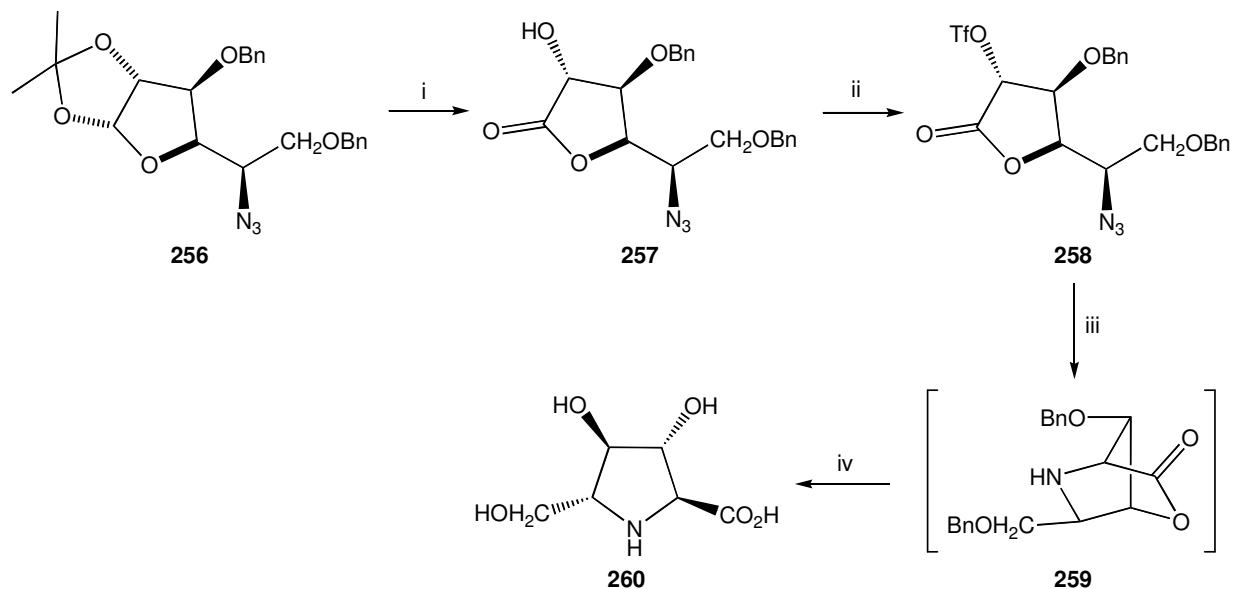

Reagents and conditions: (i) a) *p*-TsOH, H₂O, 1,4-dioxane, 92%; b) I₂, K₂CO₃, *t*-BuOH, 92%; (ii) Tf₂O, Py, CH₂Cl₂, 99%; (iii) H₂, EtOH, Pd-C; (iv) H₂, HCl, dioxane, Pd-C, 86%.

Scheme 52

Moreover, as L-glucuronolactone has recently become readily available⁸⁰ and the L-enantiomers of many imino sugars have surprising biological activities compared to their D-natural products,⁸¹ the same publication also reports the synthesis of (3*S*)-3-hydroxy-L-bulgecinine from L-glucuronolactone. As previously stated, dibromohexonolactone **42** is a valuable precursor for obtaining six-membered ring imino acid derivatives (Scheme 10). A slight modification in the synthetic route also allowed the preparation of the five-membered ring imino acid **262** (Scheme 53).²⁶

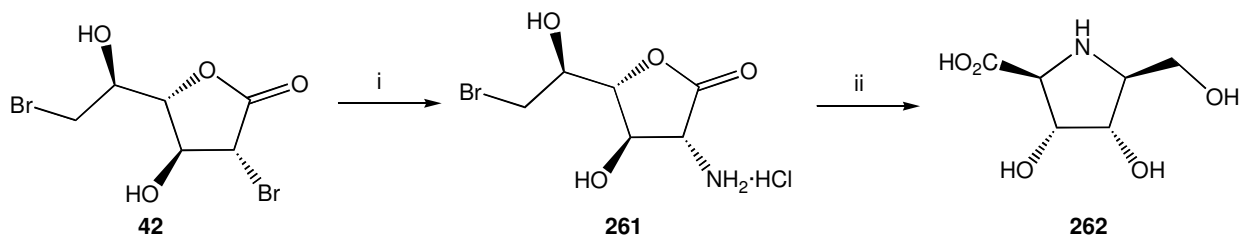

Reagents and conditions: (i) a) NaN₃, acetone, reflux, 34%; b) H₂, Pd/C, MeOH, HCl, quant.; (ii) 5 eq. KOH, H₂O, 0 °C.

Scheme 53

4. Conclusions

The past several years have witnessed explosive developments in sugar imino acid chemistry. It is now clearly the case that polyhydroxylated imino acids have strong potential therapeutic applications. On one hand, due to their inhibitory activities against various glycosidases, imino sugars have potential applications as drugs, including antidiabetics, antiobesities, antivirals and therapeutics for the treatment of some genetic disorders such as Gaucher disease.

In addition to this, sugar imino acids are suitable building blocks for the preparation of conformationally restricted peptides and peptide mimetics with improved pharmacological profiles. Looking towards the future, the widespread application of sugar amino acids in medicinal chemistry seems certain to ensure continued interest in the development of this class of synthetic amino acids.

Acknowledgments

This work was supported by the Spanish Ministry of Science and Innovation (CTQ2009-08490) and the Xunta de Galicia (Research Project CN2011/037). A.M.E. thanks the Spanish Ministry of Science and Innovation for an FPU grant. We also thank Ignasi Mon and Stuart Knight for their valuable help in the preparation and revision of this manuscript. Professors Ramon J. Estévez and Juan C. Estévez are acknowledged for helpful discussions.

References

1. (a) *Recent Advances in Peptidomimetics*; Aubé, J., Guest Ed.; Tetrahedron Symposia-in-Print, No. 83 [*Tetrahedron* **2000**, 56 (50)]; Pergamon Press: Oxford, 2000. (b) Robinson, J. A. *Synlett* **2000**, 429. (c) Smith, A. B.; Favor, D. A.; Sprengeler, P. A.; Guzman, M. C.; Carrol, P. J.; Furst, G. T.; Hirschmann, R. *Bioorg. Med. Chem.* **1999**, 7, 9. (d) Hanessian, S.; McNaughton-Smith, G.; Lombart, H.-G.; Lubell, W. D. *Tetrahedron* **1997**, 53, 12789. (e) Giannis, A.; Kolter, T. *Angew. Chem., Int. Ed. Engl.* **1993**, 32, 1244.
2. (a) Takeuchi, Y.; Marshall, G. R. *J. Am. Chem. Soc.* **1998**, 120, 5363. (b) Bellier, B.; DaNascimento, S.; Meudal, H.; Gincel, E.; Roques, B. P.; Garbay, C. *Bioorg. Med. Chem. Lett.* **1998**, 8, 1419.
3. Strausberg, R. L.; Link, R. P. *TIBTECH* **1990**, 8, 53.
4. Zacharius, R. M.; Thompson, J. F.; Steward, F. C. *J. Am. Chem. Soc.* **1952**, 74, 2949.
5. (a) Gutierrez, M. C.; Delgado-Coello, B. A. *Neurochem. Res.* **1989**, 14, 405. (b) Bernasconi, R.; Jones, R. S. G.; Bittiger, H.; Olpe, H. R.; Heid, J.; Martin, P.; Klein, M.; Loo, P.; Braunwalder, A.; Schmutz, M. *J. Neural. Transm.* **1986**, 67, 175.
6. Smith, A. B. III; Condon, S. M.; McCauley, J. A.; Leazer, J. L., Jr; Leahy, J. W.; Maleczka, R. E. *J. Am. Chem. Soc.* **1997**, 119, 962.
7. Ireland, R. E.; Gleason, J. L.; Gegnas, L. D.; Highsmith, T. K. A. *J. Org. Chem.* **1996**, 61, 6856.
8. Boger, D. L.; Chen, J. H.; Saionz, K. W. *J. Am. Chem. Soc.* **1996**, 118, 1629.
9. Copeland, T. D.; Wondrak, E. M.; Tozser, J.; Roberts, M. M.; Oroszlan, S. *Biochem. Biophys. Res. Comm.* **1990**, 169, 310.
10. Flynn, G. A.; Giroux, E. L.; Dage, R. C. *J. Am. Chem. Soc.* **1987**, 109, 7914.
11. Kadouri-Puchot, C.; Comesse, S. *Amino Acids* **2005**, 29, 101.
12. Manning, K. S.; Lynn, D. G.; Shabanowitz, J.; Fellows, L. E.; Singh, M.; Schrire, B. D. *J. Chem. Soc., Chem. Commun.* **1985**, 127.
13. di Bello, I. C.; Dorling, P.; Fellow, L. E.; Winchester, B. *FEBS Lett.* **1984**, 176, 61.
14. (a) Bashyal, B. P.; Chow, H.-F.; Fleet, G. W. J. *Tetrahedron Lett.* **1986**, 27, 3205. (b) Bashyal, B. P.; Chow, H.-F.; Fellows, F. E.; Fleet, G. W. J. *Tetrahedron* **1987**, 43, 415. (c) Fleet, G. W. J.; Fellows, F. E.; Smith, P. W. *Tetrahedron* **1987**, 43, 979. (d) Fleet, G. W. J.; Ramsden, N. G.; Witty, D. R. *Tetrahedron* **1989**, 45, 327. (e) Bashyal, B. P.; Chow, H. F.; Fleet, G. W. J. *Tetrahedron* **1987**, 43, 423.
15. Park, K. H.; Yoon, Y. J.; Lee, S. G. *J. Chem. Soc., Perkin Trans. 1* **1994**, 2621.
16. (a) Hegedus, L. S. In *Comprehensive Organometallic Chemistry II*; Abel, E. W.; Stone, F. G. A.; Wilkinson, G., Eds.; Pergamon Press: New York, 1995; Vol. 12, p. 549. (b) Hegedus, L. S. *Tetrahedron* **1997**, 53, 4105.
17. Dotz, K. H.; Haase, W. C.; Klumpe, M.; Nieger, M. *J. Chem. Soc., Chem. Commun.* **1997**, 1217.
18. Klumpe, M.; Dötz, K. H. *Tetrahedron Lett.* **1998**, 39, 3683.
19. Dötz, K. H.; Klumpe, M.; Nieger, M. *Chem. Eur. J.* **1999**, 5, 691.
20. Lee, B. W.; Jeong, I. Y.; Yang, M. S.; Choi, S. U.; Park, K. H. *Synthesis* **2000**, 9, 1305.
21. (a) Grandel, R.; Kazmaier, U. *Tetrahedron Lett.* **1997**, 38, 8009. (b) Kazmaier, U.; Grandel, R. *Eur. J. Org. Chem.* **1998**, 1833. (c) Kummeter, M.; Kazmaier, U. *Eur. J. Org. Chem.* **2003**, 3330.
22. Poupon, E.; Luong, B. X.; Chiaroni, A.; Kunesch, N.; Husson, H.-P. *J. Org. Chem.* **2000**, 65, 7208.
23. Tsimilaza, A.; Tite, T.; Boutefnouchet, S.; Lallemand, M.-C.; Tillequina, F.; Husson, H.-P. *Tetrahedron: Asymmetry* **2007**, 18, 1585.

24. (a) Ruiz, M.; Ruanova, T. M.; Ojea, V.; Quintela, J. M. *Tetrahedron Lett.* **1999**, *40*, 2021. (b) Ruiz, M.; Ojea, V.; Ruanova, T. M.; Quintela, J. M. *Tetrahedron: Asymmetry* **2002**, *13*, 795. (c) Ruiz, M.; Ruanova, T. M.; Blanco, O.; Núñez, F.; Pato, C.; Ojea, V. *J. Org. Chem.* **2008**, *73*, 2240.
25. Afarinkia, K.; Bahar, A.; Neuss, J. *Synlett* **2003**, 2341.
26. Malle, B. M.; Lundt, I.; Wrodnigg, T. M. *Org. Biomol. Chem.* **2008**, *6*, 1779.
27. (a) Moriyama, H.; Tsukida, T.; Inoue, Y.; Kondo, H.; Yoshino, K.; Nishimura, S.-I. *Bioorg. Med. Chem. Lett.* **2003**, *13*, 2737. (b) Moriyama, H.; Tsukida, T.; Inoue, Y.; Yokota, K.; Yoshino, K.; Kondo, H.; Miura, N.; Nishimura, S.-I. *J. Med. Chem.* **2004**, *47*, 1930.
28. (a) Michaelides, M. R.; Curtin, M. L. *Curr. Pharm. Des.* **1999**, *5*, 787. (b) Whittaker, M.; Floyd, C. D.; Brown, P.; Gearing, A. J. H. *Chem. Rev.* **1999**, *99*, 2735. (c) Beckett, R. P.; Whittaker, M. *Exp. Opin. Ther. Pat.* **1998**, *8*, 259. (d) Rothenberg, M. L.; Nelson, A. R.; Hande, K. R. *Oncologist* **1998**, *3*, 271.
29. Moreland, L. W.; Baumgartner, S. W.; Schiff, M. H.; Tindall, E. A.; Fleischmann, R. M.; Weaver, A. L.; Ettlinger, R. E.; Cohen, S.; Koopman, W. J.; Mohler, K. *N. Engl. J. Med.* **1997**, *337*, 141.
30. Clements, J. M.; Cossins, J. A.; Wells, G. M.; Corkill, D. J.; Helfrich, K.; Wood, L. M.; Pigott, R.; Stabler, G.; Ward, G. A.; Gearing, A. J.; Miller, K. M. *J. Neuroimmunol.* **1997**, *74*, 85.
31. Morimoto, Y.; Nishikawa, K.; Ohashi, M. *Life Sci.* **1997**, *61*, 795.
32. Nelson, F. C.; Zask, A. *Exp. Opin. Investig. Drugs.* **1999**, *8*, 383.
33. Moriyama, H.; Tsukida, T.; Inoue, Y.; Kondo, H.; Yoshino, K.; Nishimura, S.-I. *Bioorg. Med. Chem. Lett.* **2003**, *13*, 2741.
34. Marlier, M.; Dardenne, G.; Casimir, J. *Phytochemistry*, **1976**, *15*, 183.
35. Takahashi, S.; Kuzuhara, H. *Biosci. Biotech. Biochem.* **1995**, *59*, 762.
36. Kusano, G.; Ogawa, H.; Takahashi, A.; Nozoe, S.; Yokoyama, K. *Chem. Pharm. Bull.* **1987**, *35*, 3482.
37. Yoshimura, Y.; Ohara, C.; Imahori, T.; Saito, Y.; Kato, A.; Miyauchi, S.; Adachi, I.; Takahata, H. *Bioorg. Med. Chem.* **2008**, *16*, 8273.
38. Shilvock, J. P.; Nash, R. J.; Lloyd, J. D.; Winters, A. L.; Asano, N.; Fleet, G. W. J. *Tetrahedron: Asymmetry* **1998**, *9*, 3505.
39. Shilvock, J. P.; Wheatley, J. R.; Nash, R. J.; Watson, A. A.; Griffiths, R. C.; Butters, T. D.; Müller, M.; Watkin, D. J.; Winkler, D. A.; Fleet, G. W. J. *J. Chem. Soc., Perkin Trans. 1* **1999**, 2735.
40. Nishimura, Y.; Wang, W.-M.; Kondo, S.; Aoyagi, T.; Umezawa, H. *J. Am. Chem. Soc.* **1988**, *110*, 7249.
41. Nishimura, Y.; Kudo, T.; Kondo, S.; Takeuchi, T. *J. Antibiot.* **1992**, *45*, 963.
42. Nishimura, Y.; Kudo, T.; Kondo, S.; Takeuchi, T. *J. Antibiot.* **1994**, *47*, 101.
43. Knapp, S.; Zhao, D. *Org. Lett.* **2000**, *2*, 4037.
44. Nishimura, Y.; Shitara, E.; Adachi, H.; Toyoshima, M.; Nakajima, M.; Okami, Y.; Takeuchi, T. *J. Org. Chem.* **2000**, *65*, 2.
45. Brown, J. R.; Nishimura, Y.; Esko, J. D. *Bioorg. Med. Chem. Lett.* **2006**, *16*, 532.
46. (a) Igarashi, Y.; Ichikawa, M.; Ichikawa, Y. *Tetrahedron Lett.* **1996**, *37*, 2707. (b) Ichikawa, Y.; Igarashi, Y.; Ichikawa, M.; Suhara, Y. *J. Am. Chem. Soc.* **1998**, *120*, 3007.
47. Zhao, G.; Deo, U. C.; Ganem, B. *Org. Lett.* **2001**, *2*, 201.
48. Kim, Y. J.; Ichikawa, M.; Ichikawa, Y. *J. Org. Chem.* **2000**, *65*, 2599.
49. Chen, C.; Yu, B. *Tetrahedron Lett.* **2008**, *49*, 672.
50. Krishna, P. R.; Reddy, P. S. *J. Comb. Chem.* **2008**, *10*, 426.
51. (a) Morris, S. A.; Schwartz, D. M.; Sesin, D. F.; Masurekar, P.; Hallada, T. C.; Schwartz, D. M.; Bartizal, K.; Hensens, O. D.; Zink, D. L. *J. Antibiot.* **1994**, *47*, 755. (b) Waite, J. H.; Tanzer, M. L. *Science* **1981**, *212*, 1038. (c) Bann, J. G.; Bachinger, H. P. *J. Biol. Chem.* **2000**, *275*, 24466.
52. (a) Cordova, A.; Notz, W.; Barbas, C. F., III. *J. Org. Chem.* **2002**, *67*, 301. (b) Tang, Z.; Jiang, F.; Yu, L.-T.; Cui, X.; Gong, L.-Z.; Mi, A.-Q.; Jiang, Y.-Z.; Wu, Y.-D. *J. Am. Chem. Soc.* **2003**, *125*, 5262.
53. (a) Garcia, A. L. L.; Correia, C. R. D. *Tetrahedron Lett.* **2003**, *44*, 1553. (b) Kim, J. H.; Long, M. J. C.; Kim, J. Y.; Park, K. H. *Org. Lett.* **2004**, *6*, 2273. (c) Angle, S. R.; Belanger, D. S. *J. Org. Chem.* **2004**, *69*, 4361.
54. (a) Imada, A.; Kintaka, K.; Nakao, M.; Sinagawa, S. *J. Antibiot.* **1982**, *35*, 1400. (b) Shinagawa, S.; Maki, M.; Kintaka, K.; Imada, A.; Ajai, M. *J. Antibiot.* **1985**, *38*, 17. (c) Shinagawa, S.; Kasahara, F.; Wada, Y.; Harada, S.; Asai, M. *Tetrahedron* **1984**, *40*, 3465.

55. Wakamiya, T.; Yamanoi, K.; Nishikawa, M.; Shiba, T. *Tetrahedron Lett.* **1985**, *26*, 4759.
56. Barrett, A. G. M.; Pilipauskas, D. *J. Org. Chem.* **1990**, *55*, 5194. (b) Barrett, A. G. M.; Pilipauskas, D. *J. Org. Chem.* **1991**, *56*, 2787.
57. Ohta, T.; Hosoi, A.; Nozoe, S. *Tetrahedron Lett.* **1988**, *29*, 329.
58. Hirai, Y.; Terada, T.; Amemiya, Y.; Momose, T. *Tetrahedron Lett.* **1992**, *33*, 7893.
59. Zhou, P.; Salleh, H. M.; Honek, J. F. *J. Org. Chem.* **1993**, *58*, 264.
60. Yuasa, Y.; Ando, J.; Shibuya, S. *J. Chem. Soc., Chem. Commun.* **1994**, 1383.
61. Schmeck, C.; Hegedus, L. S. *J. Am. Chem. Soc.* **1994**, *116*, 9927.
62. Fehn, S.; Burger, K. *Tetrahedron: Asymmetry* **1997**, *12*, 2001.
63. Burk, M. J.; Allen, J. G.; Kiesman, W. F. *J. Am. Chem. Soc.* **1998**, *120*, 657.
64. Krasinski, A.; Jurczak, J. *Tetrahedron Lett.* **2001**, *42*, 2019.
65. Khalaf, J. K.; Datta, A. *J. Org. Chem.* **2004**, *69*, 387.
66. Chavan, S. P.; Praveen, C.; Sharma, P.; Kalkote, U. R. *Tetrahedron Lett.* **2005**, *46*, 439.
67. Chandrasekhar, S.; Chandrashekar, G.; Vijeender, K.; Sarma, G. D. *Tetrahedron: Asymmetry* **2006**, *17*, 2864.
68. Trost, B. M.; Horne, D. B.; Woltering, M. J. *Chem. Eur. J.* **2006**, *12*, 6607.
69. Toumi, M.; Couty, F.; Evano, G. *Tetrahedron Lett.* **2008**, *49*, 1175.
70. Panday, S. K.; Langlois, N. *Synthetic Commun.* **1997**, *27*, 1373.
71. Porzi, G.; Sandri, S. *Tetrahedron: Asymmetry* **1996**, *7*, 189.
72. Oppolzer, W.; Moretti, R.; Zhou, C. *Helv. Chim. Acta* **1994**, *77*, 2363.
73. Holt, K. E.; Swift, J. P.; Smith, M. E. B.; Taylor, S. J. C.; McCague, R. *Tetrahedron Lett.* **2002**, *43*, 1545.
74. Lee, R. E.; Smith, M. D.; Nash, R. J.; Griffiths, R. C.; McNeil, M.; Grewal, R. K.; Yan, W.; Besra, G. S.; Brennan, P. J.; Fleet, G. W. J. *Tetrahedron Lett.* **1997**, *38*, 6733.
75. (a) Donohoe, T. J.; Sintim, H. O. *Org. Lett.* **2004**, *6*, 2003. (b) Donohoe, T. J.; Sintim, H. O.; Hollinshead, J. *J. Org. Chem.* **2005**, *70*, 7297.
76. Moreno-Vargas, A. J.; Robina, I.; Petricci, E.; Vogel, P. *J. Org. Chem.* **2004**, *69*, 4487.
77. (a) Blanco, O.; Pato, C.; Ruiz, M.; Ojea, V. *Org. Biomol. Chem.* **2008**, *6*, 3967. (b) Blanco, O.; Pato, C.; Ruiz, M.; Ojea, V. *Org. Biomol. Chem.* **2009**, *7*, 2310.
78. Moura, M.; Delacroix, S.; Postel, D.; Nhien, A. N. V. *Tetrahedron* **2009**, *65*, 2766.
79. Best, D.; Wang, C.; Weymouth-Wilson, A. C.; Clarkson, R. A.; Wilson, F. X.; Nash, R. J.; Miyauchi, S.; Kato, A.; Fleet, G. W. J. *Tetrahedron: Asymmetry* **2010**, *21*, 311.
80. Weymouth-Wilson, A. C.; Clarkson, R.; Jones, N. A.; Best, D.; Wilson, F. X.; Pino-Gonzalez, M.-S.; Wilson, F. X.; Fleet, G. W. J. *Tetrahedron Lett.* **2009**, *50*, 6307.
81. (a) D'Alonzo, D.; Guaragna, A.; Palumbo, G. *Curr. Med. Chem.* **2009**, *16*, 473. (b) Clinch, K.; Evans, G. B.; Fleet, G. W. J.; Furneaux, R. H.; Johnson, S. W.; Lenz, D.H.; Mee, S. P. H.; Rands, P. R.; Schramm, V. L.; Ringia, E. A. T.; Tyler, P. C. *Org. Biomol. Chem.* **2006**, *4*, 1131. (c) Smith, S. S. *Toxicol. Sci.* **2009**, *110*, 4. (d) Rountree, J. S. S.; Butters, T. D.; Wormald, M. R.; Boomkamp, S. D.; Dwek, R. A.; Asano, N.; Ikeda, K.; Evinson, E. L.; Nash, R. J.; Fleet, G. W. J. *ChemMedChem* **2009**, *4*, 378. (e) Mercer, T. B.; Jenkinson, S. F.; Bartolomew, B.; Nash, R. J.; Miyauchi, S.; Kato, A.; Fleet, G. W. J. *Tetrahedron: Asymmetry* **2009**, *20*, 2368.

RECENT ADVANCES IN GOLD CATALYZED INTER- AND INTRAMOLECULAR FUNCTIONALIZATION OF HETEROAOMATIC COMPOUNDS

Monica Dell'Acqua, Diego Facchetti, Valentina Pirovano, Giorgio Abbiati and Elisabetta Rossi

DISMAB – Sezione di Chimica Organica “A. Marchesini”, Università degli Studi di Milano,

Via G. Venezian 21, I-20133 Milano, Italy (e-mail: elisabetta.rossi@unimi.it)

Abstract. *Recent advances in the gold catalyzed functionalization of heteroaromatic compounds are surveyed.*

Contents

1. Introduction
 2. Gold catalyzed Friedel-Crafts type reactions
 3. Hydroheteroarylation of C=O bonds
 4. Hydroheteroarylation of carbon-carbon multiple bonds
 - 4.1. Hydroheteroarylation of activated alkenes and alkynes
 - 4.2. Hydroheteroarylation of unactivated alkenes
 - 4.3. Hydroheteroarylation of allenes
 - 4.4. Hydroheteroarylation of unactivated alkynes
 5. Direct alkynylations
 6. Reactions involving rearrangement
 7. Domino reactions
 8. Concluding remarks
- References

1. Introduction

Gold catalysis has emerged as a new valuable tool for organic synthesis in relatively recent years, as demonstrated by the exponential growth of papers and reviews covering the different aspects of gold catalysis over the past ten years. The renewed interest in gold catalyzed processes is related to the specific feature of gold salts to activate unsaturated C–C and C–heteroatoms bonds. More in depth, gold(III) and gold(I) (especially in his cationic arrangement) species are classified as soft Lewis acids displaying exceptional carbophilicity (π -electrophilic properties) and at the same time lone pairs affinity (σ -electrophilic properties).¹ As a consequence, Au catalysis can be applied to a broad range of chemical transformations, such as additions of N, O, S, and C nucleophiles to activated and unactivated C–C unsaturated bonds, Friedel-Crafts type reactions, activation of carbonyl and imine groups, cycloisomerization of enynes and heteroenynes, activation of C–H bonds of terminal alkynes. Furthermore, gold catalysts are able to participate in one or more steps of multicomponent, domino and cascade reactions. Finally, stereoselection is one of the most recent development in gold catalysis. The chemical diversity achieved in gold catalyzed reactions is completed by the mild reaction conditions requested and by the low toxicity and high stability of gold salts. Importantly, the catalytic activity and the mechanisms of gold catalyzed reactions deviate from

those of more famous transition metals such as palladium, thus adding new opportunities and different reaction scopes.

The most recent reviews published on this topic can be organized in four main categories: general reviews covering mechanistic aspects,² ligand effects,³ general⁴ and specific applications⁵ of gold catalysis.

The present review focuses on the recent progresses in gold catalyzed functionalization of heteroaromatic compounds. The selected papers arise from the literature ranging from 2005 to 2011. The specific topic includes in the first five sections a broad range of simple functionalization reactions involving the formation of new C–C bonds through Friedel-Crafts type reactions, additions to C=O and C=N⁺ functional groups, hydroarylation of carbon-carbon multiple bonds and direct alkynylations of heterocycles. In two additional sections, more complex reactions involving migration of the heteroaryl group and domino reactions are detailed. It is worth to note that the selected papers include both simple intermolecular functionalizations and intramolecular reactions giving rise to annulated compounds.

In Friedel-Crafts type reactions (Section 2) the use of gold allows for the substitution of alkyl chlorides by other, less toxic, alkylating reagents such as alcohols or amides and are performed in the presence of catalytic amounts of gold(III) salts instead of stoichiometric amounts of Lewis or Brønsted acids. Moreover, exploiting the dual role of gold catalysts, a cationic dinuclear gold(I) complexes with a chiral phosphine has been used in stereoselective intramolecular allylic alkylation of indoles. The condensation reactions of electron-rich heterocycles with carbonyl compounds (Section 3) take advantage from gold catalyst as alternative mild and water-tolerant Lewis acid. The latest developments in the use of gold catalysts as carbophilic late-transition metal species for hydroarylation and direct alkynylation reactions are reported in Sections 4 and 5, respectively. Both hydroarylation and alkynylation reactions can be realized by direct addition or direct coupling without functionalization of the starting materials thus representing economically and environmentally benign methodologies. The 1,2- and 1,5-indol migrations in indoles containing a tethered C–C triple bond for the synthesis of 3-indenylindoles, 3-dienylindoles and 3-allenylindoles (Section 6) can be viewed as a particular class of reactions involving a gold carbene complex as intermediate. Finally, in Section 7, domino reaction, in which gold is involved in more than one step of the domino pathway, are reported. These reactions highlight once again the dual role of gold catalysts (π - and σ -philic Lewis acid). Domino reactions involving a single gold mediated step are reported in the previously described appropriate sections.

Mechanisms for gold mediated steps are reported for each reaction even if they are in most cases only proposed and not demonstrated. The state of the art on the mechanisms involved in gold catalyzed reactions has been recently highlighted by Hashmi.^{2a} His review underlined the intermediates identified by direct observation or by characterization and categorized them in two classes: reactions involving organo-gold compounds and complexes as intermediates or organic intermediates in gold catalyzed reactions. Therefore, the mechanisms discussed in this review must be understood under these guidelines.

2. Gold catalyzed Friedel-Crafts type reactions

Friedel-Crafts reaction still belongs to the most important C–C bond coupling processes and remains the method of choice for alkylation of arenes and heteroarenes. Different Lewis acids including BF₃, BeCl₂, TiCl₄, SbCl₅ or SnCl₄ have been described as catalysts for this transformation as well as strong Brønsted-acids including sulfuric acid and hydrofluoric acid. Despite the great importance of the Friedel-Crafts

alkylation in organic synthesis, the major drawbacks are the requirement of stoichiometric amounts of Lewis or Brønsted acid and toxic alkyl halides. With the need for more environmentally and economically benign processes, the development of Friedel-Crafts reactions using only catalytic amounts of metal or acid catalysts would be highly desirable. In addition, the substitution of the alkyl chlorides by other, less toxic, alkylating reagents such as alcohols would be a major improvement as water would be the only side product.⁶ To this scope the use of gold catalysis has demonstrated to be very promising, allowing the use of propargylic, allylic or benzylic alcohols as pre-electrophiles.

The direct substitution of propargylic alcohols (Scheme 1) has been for years a relatively unexplored reaction compared to those on allylic and benzylic substrates. The traditionally used Nicholas protocol requires stoichiometric amount of $[\text{Co}_2(\text{CO})_8]$.⁷ In 2003, oxo-rhenium catalysts have been described by Toste and coworkers⁸ for substitution reactions with alcohols, allylic silane, arenes and nitrogen nucleophiles. Then, in 2007 Takay⁹ reported the use of $[\text{ReBr}(\text{CO})_3\text{thf}]_2$ as catalyst.

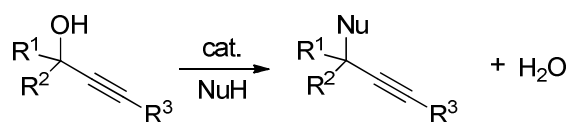

Scheme 1

Gold(III) catalyzed direct nucleophilic substitutions on propargylic alcohols have been firstly described in 2005 by Champagne and coworkers¹⁰ and furthermore explored in 2008¹¹ using various C-, O- and S-nucleophiles. According to that procedure, substitution products were obtained using 5 mol% of $\text{NaAuCl}_4 \cdot 2\text{H}_2\text{O}$ in dichloromethane at room temperature. The reaction was tested for a diverse collection of nucleophiles, in particular electron-rich aromatic rings, alcohols, thiols, sulfonamides. Between hetero-aromatic compounds, a unique example is reported with furan as nucleophile (Scheme 2).

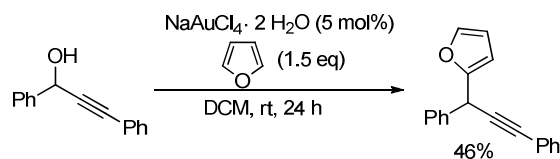

Scheme 2

From a mechanistic point of view, the authors first believed that gold might act as a propargylic alcohol activating agent, through coordination to the π -bond.¹⁰ However, the lack of reactivity of propargylic alcohols bearing an electron-withdrawing substituent or even an alkyl groups at the propargylic carbon or an ester group on the alkyne (R^2) suggested a mechanism that involves the formation of stabilized propargylic carbocation. In order to test this hypothesis, an enantiomerically enriched propargylic alcohol was reacted with allyltrimethylsilane in presence of Au(III) catalyst. The corresponding allylated product was obtained in a racemic form, thus confirming the hypothesis of a carbocation intermediate (Scheme 3).

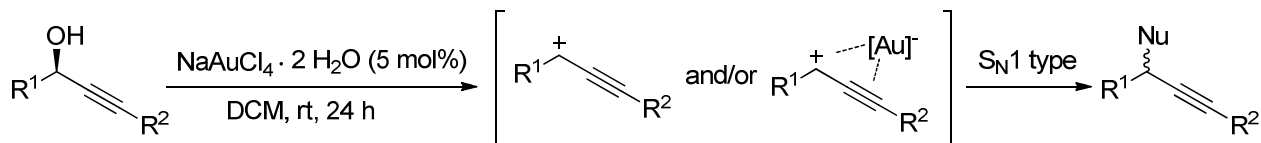

Scheme 3

In 2008, Kim and coworkers examined the use of propargylic amine derivatives instead of propargylic alcohols as precursors of carbocation species generated by cleavage of C–N bond.¹² In particular, the reaction of *N*-tosyl derivatives of propargyl amines with arenes and heteroarenes provided a useful method for the synthesis of 1,3-diarylpropynes. The use of 5 mol% of AuCl₃ in dichloroethane at room temperature provided the best results, even if the reaction occurred also with 10 mol% of FeCl₃ at room temperature or with 10 mol% of *p*-toluenesulfonic acid in refluxing dichloroethane. The reaction was performed with various heterocycles as nucleophiles such as furan, 2-methylfuran and pyrrole leading to the products with satisfactory yields (Scheme 4).

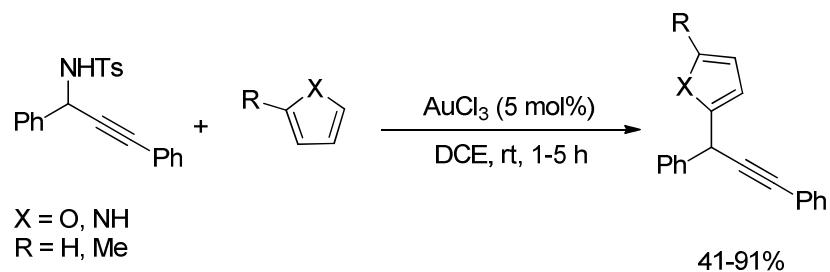

Scheme 4

The hydroxyl moiety of propargylic alcohols can also be protected as silyl ether and incorporated in more functionalized structures as described by the group of Kirsch in 2008. In this work, the authors proposed the reaction of 3-silyloxy-1,4-enynes with alcohols under gold(III) catalysis in order to form pent-2-en-4-ynyl ethers as regioselective nucleophilic substitution products.¹³ Among all the gold species, K[AuCl₄] resulted to be the best catalyst and the reactions were performed under open-flasks conditions. Other gold(III) catalysts such as HAuCl₄·4H₂O and AuCl₃ as well as gold(I) species like AuCl and [(Me₃P)AuSbF₆] resulted in markedly reduced yields. Furan was also used instead of alcohols as nucleophile and led to the formation of substituted product in albeit low yield (32%) (Scheme 5). From a mechanistic point of view, the authors did not propose detailed study for the substitution reactions that may involve a S_N1- or S_N2-like nucleophilic attack. Nevertheless, the triple bond was beneficial to the reaction outcome since either no conversion or complete decomposition was obtained with 3-trimethylsilyloxyalkenes where the propargylic alcohol moiety was not present.

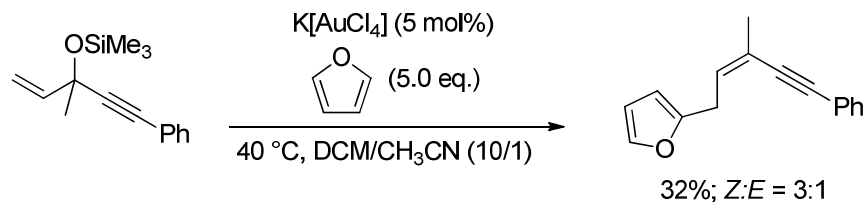

Scheme 5

The development of new methodologies that make use of inexpensive and readily available electrophiles, mild reaction conditions and environmentally-friendly catalyst for the Friedel-Crafts allylic alkylation of aromatic and heteroaromatic compounds is still a challenge in organic synthesis.¹⁴ A promising approach is represented by the replacement of classical Friedel-Crafts allylating agents such as allylic acetates, carbonates and halides with allylic alcohols in the presence of a variety of transition metal and Brønsted acid catalysts.¹⁵ In this context, gold salts have demonstrated to be versatile catalysts for Friedel-

Crafts allylic alkylations with allylic alcohols as reported by Rao and Chan in 2008, where the functionalization of arenes and heteroarenes was obtained in very good yields and high regioselectivity using AuCl_3 under mild conditions (Scheme 6).¹⁶

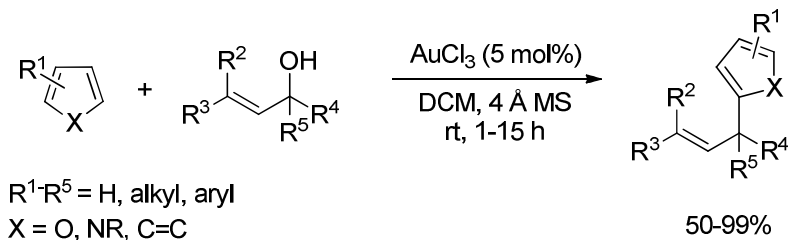

Scheme 6

The same reaction performed with other Lewis or Brønsted acids such as AuCl , CuBr_2 , ZnCl_2 and HCl produced slightly lower yields (81–90%), while the use of PPh_3AuCl , PPh_3AuOTf , AgOTf , AgSbF_6 or $\text{Yb}(\text{OTf})_3$ led to significant reduction in the formation of products (5–48%).

Among heterocycles, pyrrole, furan and *N*-methylindole were found to be reactive, yielding the allylated products with high efficiency. The regioselectivity of all the reactions was complete, giving C–C bond formation only at C-2 of pyrrole and furan and at C-3 of indole (Scheme 7).

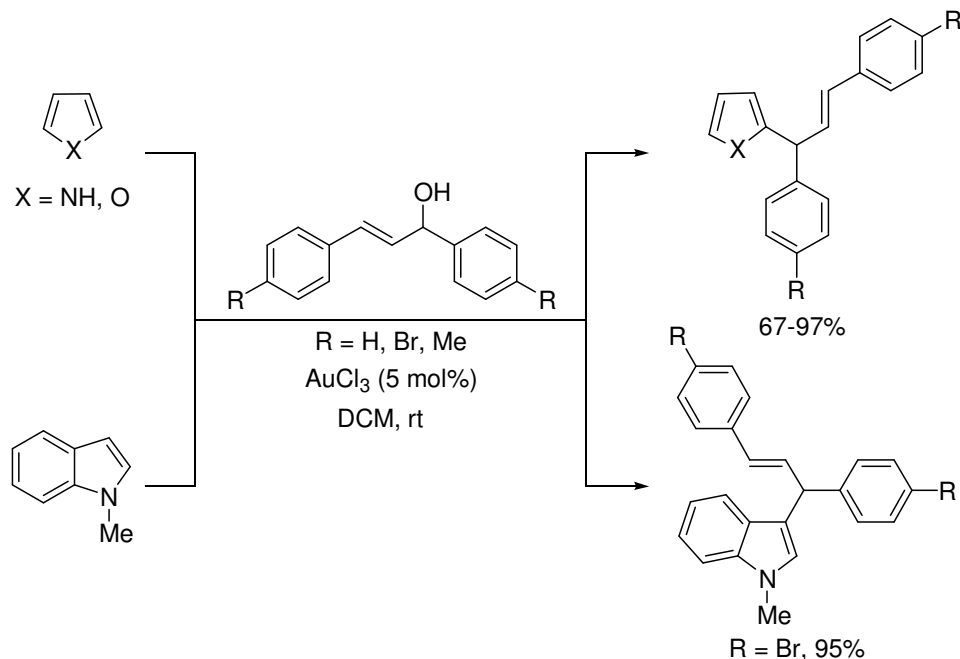

Scheme 7

The authors proposed the reaction to proceed in a manner similar to that put forward by Champagne in 2005,¹⁰ thus involving the activation of allylic alcohol by gold, making the hydroxyl to become a better leaving group.

The use of allylic alcohols has also been described for intramolecular functionalizations. Bandini and coworkers reported in 2008¹⁷ and in a full account in 2011¹⁸ the gold(I) catalyzed stereoselective intramolecular allylic alkylation of indoles, leading to enantiomerically enriched tetrahydrocarbazoles and tetrahydrocarbolines. These reactions documented for the first time the direct gold(I) catalyzed activation of

alcohols in Friedel-Crafts-type alkylations and represent a reliable alternative to the stereoselective Tsuji-Trost allylic alkylation of arenes.¹⁹

Considering the presence in the allylic alcohol moiety of adjacent π -base centre (C=C bond) and hard σ -base unit (hydroxyl group), chiral dinuclear gold(I) complexes were selected as suitable catalysts for the reaction because of their dual function (σ - and π -acidity) that would lead to conformationally rigid adducts between the Friedel-Craft precursor and the catalyst. In this way, the chiral Lewis acid promoter should be capable to activate the hydroxyl group as a leaving group without the formation of an allylic carbocation species (S_N1 -type mechanism) that would preclude any stereochemical control in the course of the reaction.

As consequence, the reaction of indolyl alcohols with chiral bis-gold(I) biarylphosphine complexes of the general formula $[(P-P)Au_2X_2]$ and silver salts furnished vinyltetrahydrocarbazoles with good yields and enantiomeric excesses. The gold(I) complexes were generated *in situ* from $AuCl \cdot SMe_2$ in CH_2Cl_2 with a ratio between ligand/Au/Ag of 10/20/20 mol%. Best results were achieved using *t*-Bu₂-4-MeO-MeObiphep in toluene at 0 °C for 24–48 hours and with OTf^- as counterion. Both 3- and 2-indolyl alcohols were found to be reactive at the reaction conditions, affording 1- and 4-vinyltetrahydrocarbazoles respectively (Scheme 8).

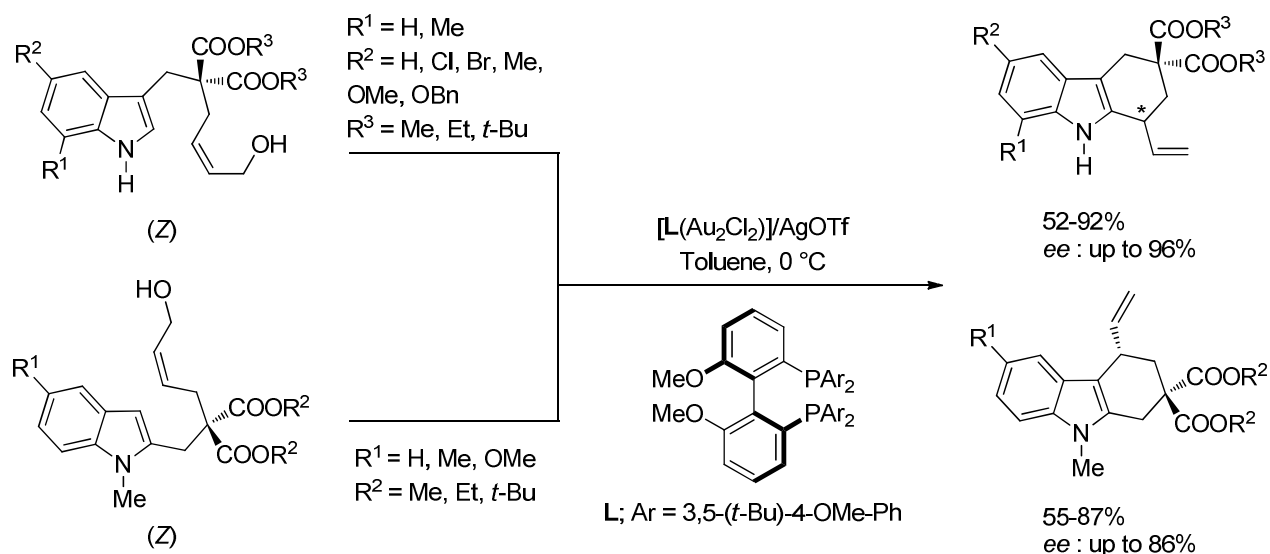

The method was applied to the synthesis of 4-vinyltetrahydro- β -carbolines starting from the corresponding alcohols. Also in this case, the use of *t*-Bu₂-4-MeO-MeObiphep as ligand produced the best results in term of yields and enantioselectivity. Unfortunately, the methodology was not applicable to the synthesis of 1-vinyl-tetrahydro- γ -carbolines, because of the unreactivity of corresponding C-3 substituted indolyl alcohols (Scheme 9).

Interestingly, the configuration of the C–C double bond of the acyclic precursor played a key role both on the malonate and nitrogen-tethered substrates. In fact, the corresponding *E*-allylic alcohols were completely inert toward the cyclization conditions, probably due to an unfavourable spatial arrangement of the sterically demanding bimetallic catalyst.

Although conclusive evidences were not obtained, the author proposed a mechanism that consider the simultaneous C=C/O–H activation, forming bimetallic complex **A**, followed by intramolecular Friedel-

Crafts alkylation to generate **B** and final rearomatization with regeneration of active catalytic species to form the desired product (Scheme 10, path a). An analogous pathway that involves monometallic gold activation and Brønsted-acid assisted β -hydroxyl elimination cannot be, however, excluded (Scheme 10, path b).

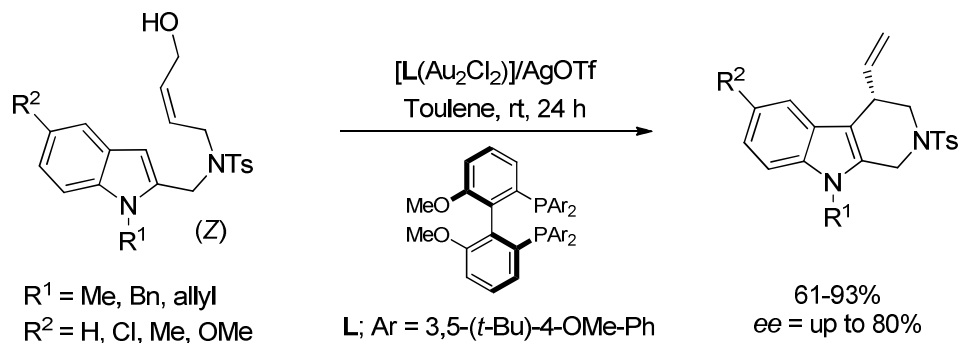

Scheme 9

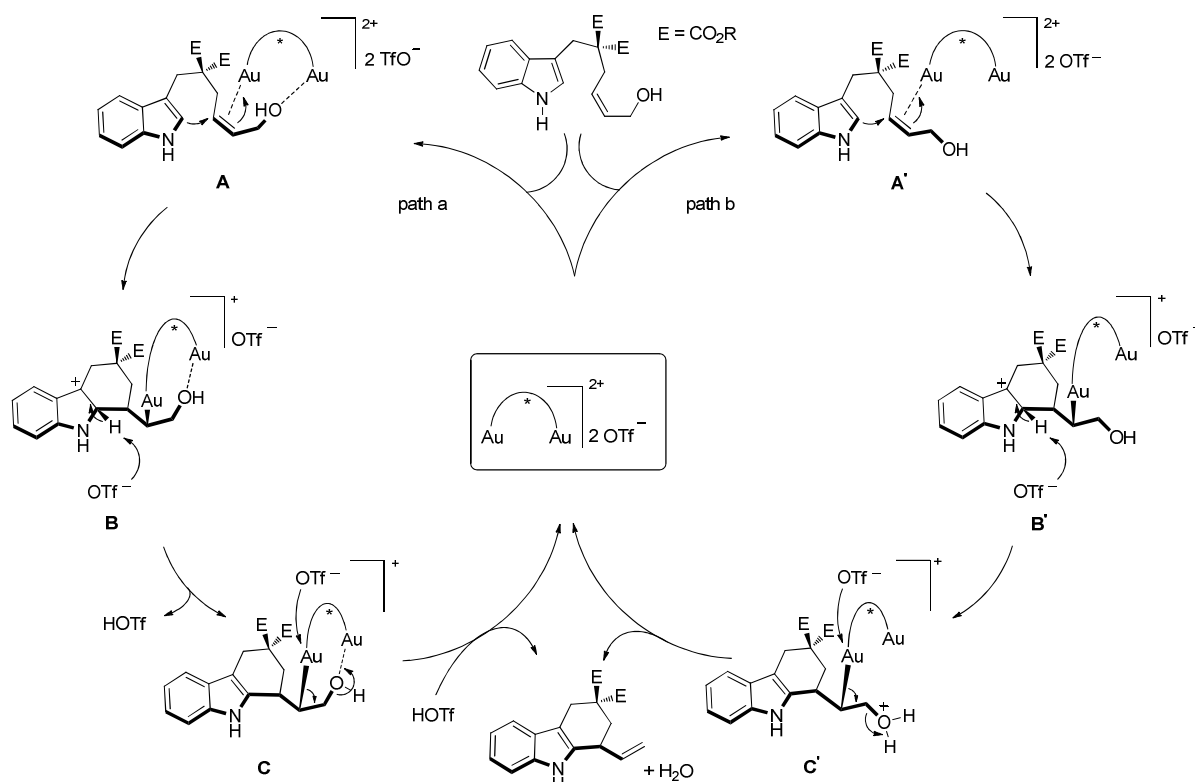

Scheme 10

Besides propargylic and allylic electrophiles, the use of benzylic alcohols and derivatives in gold catalyzed Friedel-Crafts reactions has also been explored. For example gold(III) chloride can catalyze Friedel-Crafts alkylation of arenes with benzylic acetates as reported by Beller and coworkers,²⁰ as well as directly with benzylic alcohol as described by the group of Dyker.²¹

In 2008, Bach and coworkers applied gold(III) catalysis for the diastereoselective conversion of various benzylic acetates to the corresponding S_N1 type substitution products, using not only arenes but also heterocyclic compounds as nucleophiles.²² This work started from previous studies on Friedel-Crafts alkylation using chiral benzylic alcohols in the presence of stoichiometric amounts of $\text{HBF}_4 \cdot \text{OEt}_2$ as Brønsted acid, in which the *syn*- or *anti*- products were predominantly formed depending on the substitution

of benzylic alcohol. The same results could also be obtained using catalytic amounts of AuCl₃, at room temperature with comparable diastereoselection. The choice of gold as catalyst for the study was due to its superior functional group compatibility with respect to FeCl₃ or Bi(OTf)₃. Thus different heteroarenes such as thiophene, pyrrole, furan as well as benzofuran derivatives were efficiently converted in corresponding *anti*-products, as shown in Scheme 11.

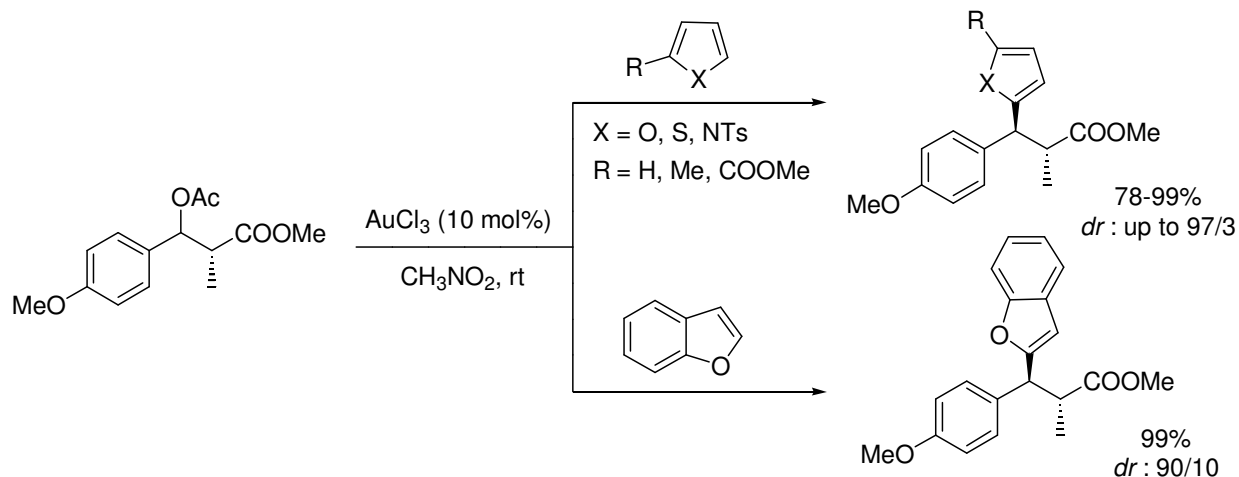

Scheme 11

To account for the observed diastereoselectivity, the authors suggested a model according to which the free carbenium ion intermediate adopts a preferred conformation dictated by 1,3-allylic strain²³ with the nucleophile approaching from the less congested face.

3. Hydroheteroarylation of C=O bonds

The reaction of electron-rich heteroarenes with carbonyl compounds could formally give rise to simple addition or condensation products (Scheme 12).

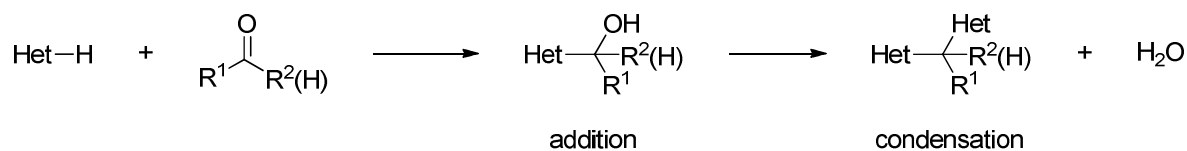

Scheme 12

In the first step, a secondary or tertiary alcohol is formed (addition product) and in the second step the reaction with a second molecule of the electron-rich heteroarene give rise to bi- or triheteroarylmethanes (condensation product). Normally, in the presence of Brønsted or Lewis acid catalysts, a two-fold reaction takes place giving rise selectively to bi- or triheteroarylmethanes²⁴ which have found useful applications in medicinal chemistry, in dye and food industries and in synthetic chemistry as protecting group.²⁵ To avoid complex procedures or harsh reaction conditions, several mild and efficient methods were developed to achieve these transformations which used [Ir(COD)Cl]₂-SnCl₄,²⁶ Cu(OTf)₂, Sc(OTf)₃²⁷ and FeCl₃²⁸ as catalysts.

Condensation compounds arising from a gold(III) catalyzed reactions between electron-rich heteroarenes and carbonyl compounds were observed by Hashmi during his studies on gold(III) catalyzed hydro-

arylations of α,β -unsaturated aldehydes and ketones.²⁹ When these latter reactions were carried out using acetone as solvent, a competitive reaction took place giving rise, beside the desired Michael-type adduct, to a condensation compound arising from a two-fold addition of the heteroarene on acetone. The reaction was monitored by ¹H-NMR using hexadeuteroacetone as solvent. Further studies demonstrated that gold(III) chloride as well as mercury(II) perchlorate, thallium(III) perchlorate and *p*-toluenesulfonic acid efficiently catalyze the condensation of two 2-methylfurans with aldehydes or acetone (Scheme 13).

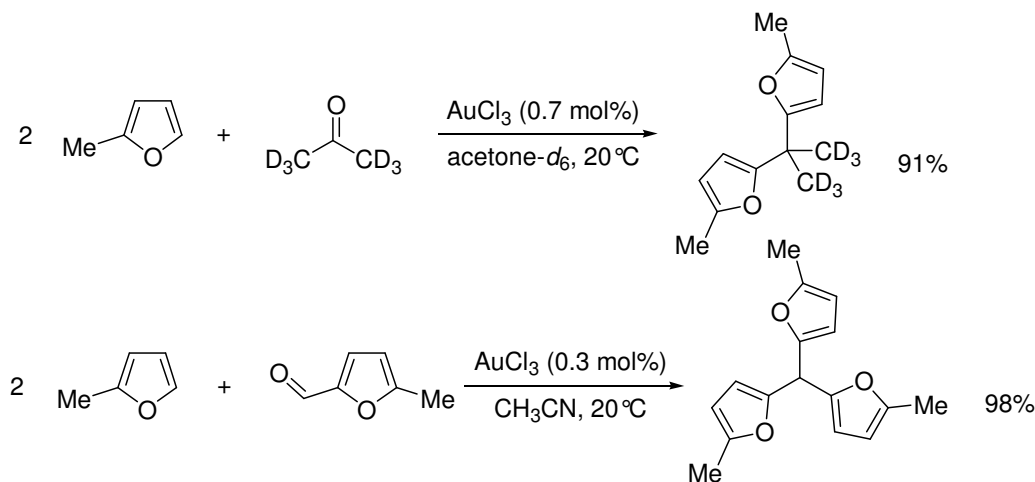

Scheme 13

While mercury and thallium salts due to their toxicity are not an alternative to Brønsted acids with non-nucleophilic counterions, gold catalysis may represent a useful alternative due to the milder reaction conditions.

A practical synthesis of triheteroarylmethanes by reaction of aldehydes and activated heteroarenes promoted by gold(III) chloride was developed by Nair and coworkers.³⁰ They demonstrated that electron-rich heteroaromatic systems undergo efficient condensation reactions with various aldehydes furnishing, beside simple triheteroaryl systems, also fascinating more complex molecules which can serve as core structure for dendritic architectures. Several examples of this chemistry are shown in Scheme 14. It is worth to note that, when 2-methylthiophene is used as substrate, a cationic gold species, generated from gold trichloride and silver triflate, is the catalyst required to achieve the desired compound in good yield.

Although only indirect evidences were reported on the mechanism involved,^{30b,31} all the reported reactions could be regarded as encompassing C–H activation of the heteroarene to form an heteroaryl-gold species which adds to the carbonyl group (ketone or aldehyde) (Scheme 15).

Protonation would release the addition compound which reacts with a second molecule of the heteroaryl-gold species delivering the condensation product, along with the free catalyst. However, the reaction could also proceed through a simple Lewis acid activation of the carbonyl group, followed by a Friedel-Crafts type reaction with the heteroarene.

Indoles and pyrroles can be directly coupled with 1,3-dicarbonyls yielding the corresponding alkenyl derivatives in the presence of gold(III) salts.³² These reactions represent a valuable alternative to classical Friedel-Craft alkylation and acylation (Scheme 16). Gold shows higher catalytic activity in the higher oxidation state. Generally, NaAuCl₄·2H₂O (5 mol%) in acetonitrile afforded satisfactory results. AuCl₃ and AuBr₃ also catalyzed the reactions, more effectively in the presence of Ag(I) salts.

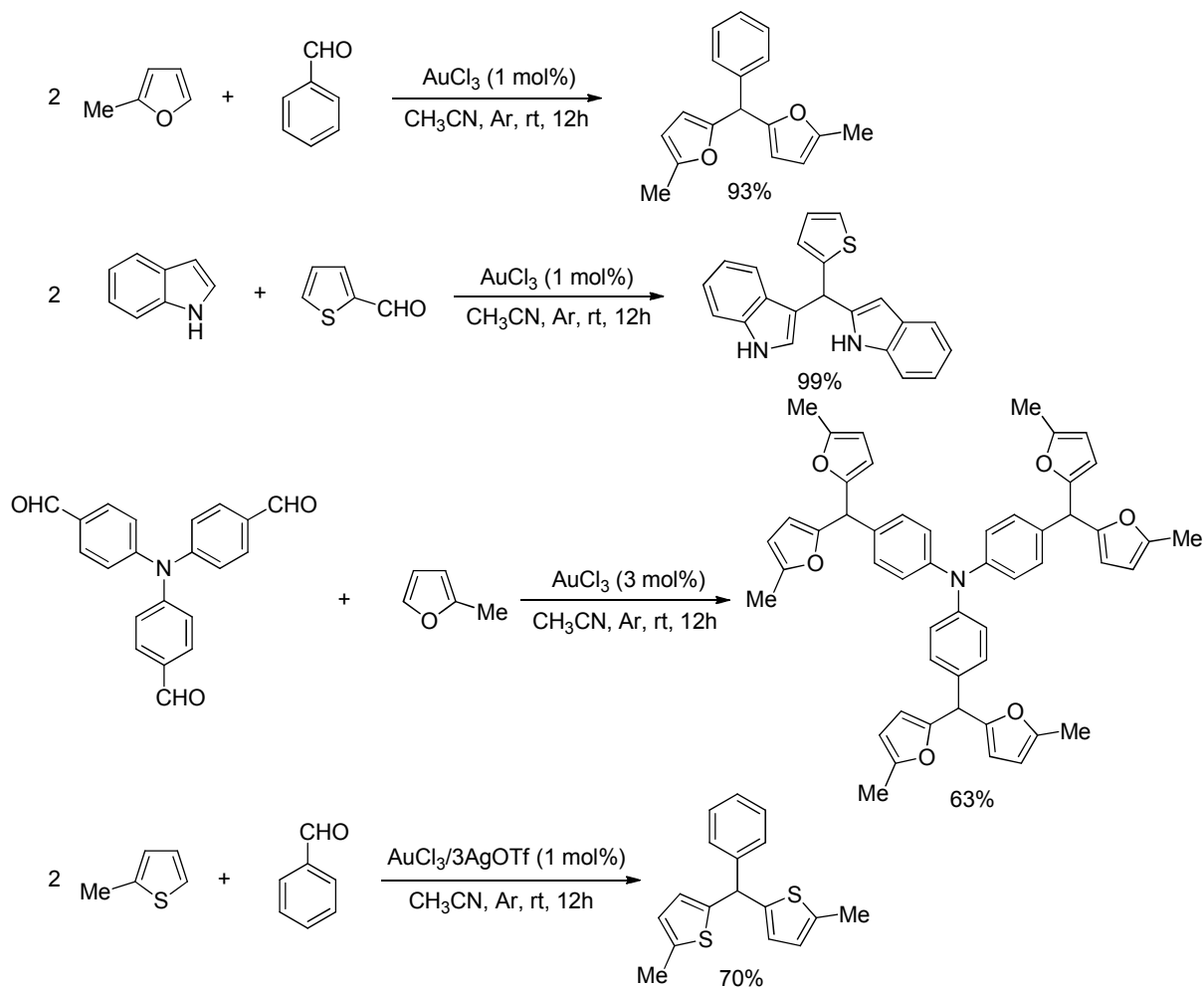

Scheme 14

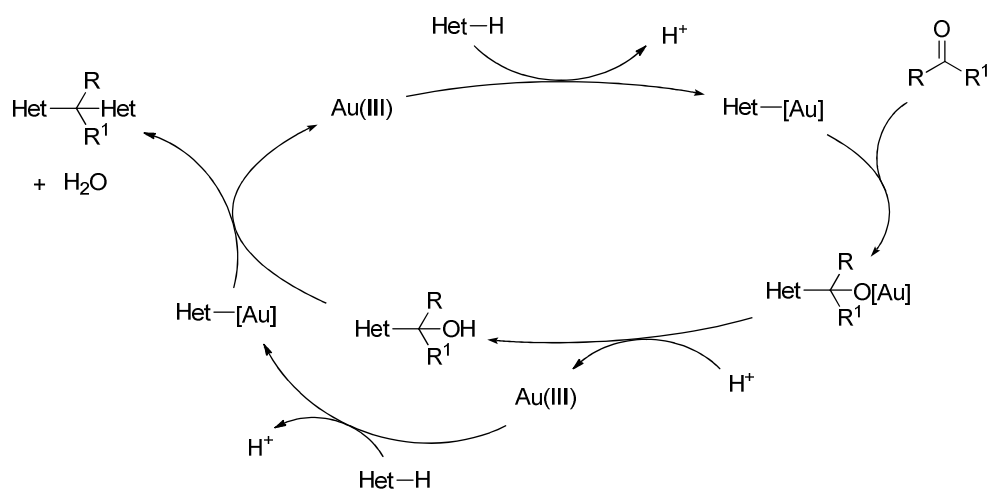

Scheme 15

Pyrrole itself and 2-substituted pyrroles underwent electrophilic substitution exclusively at α -position. The reactions were clean and polymerization products, normally formed in the presence of strong acids, were not observed. For a comparison, the reactions of pyrrole with 1,3-cyclohexanedione in 1,2-dichloroethane at 80 °C in the presence of a catalytic amount of *p*-toluenesulfonic acid led mainly to polymerization derivatives and the desired alkenyl derivative was isolated in only 26% yield.

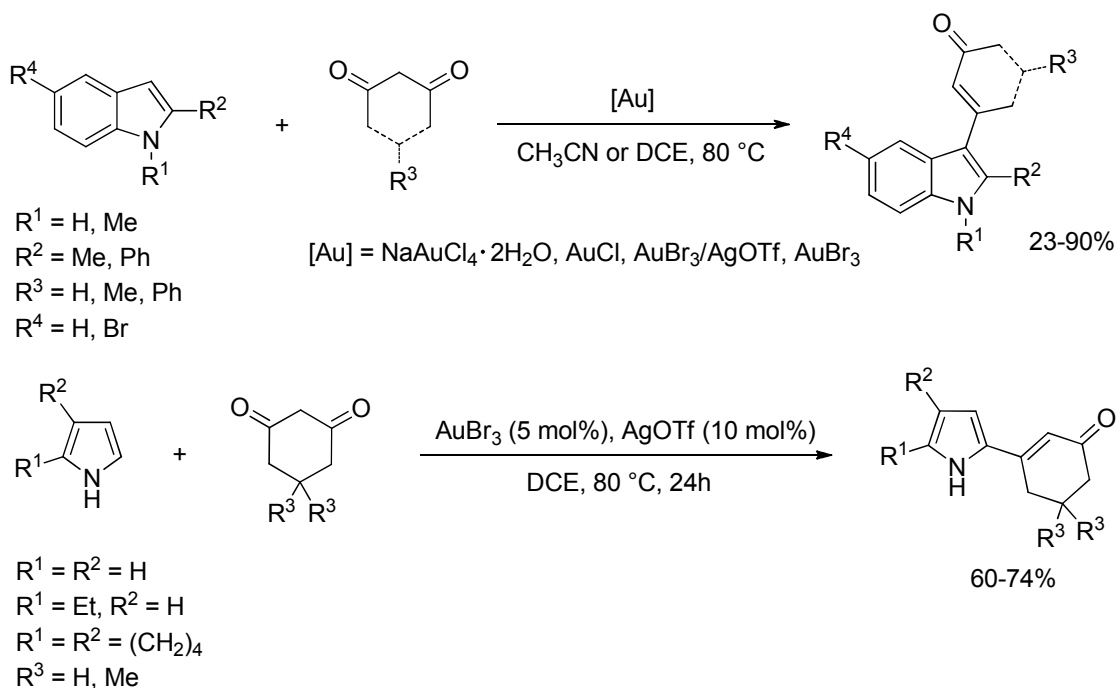

Scheme 16

The authors reported also two examples of the gold catalyzed sequential cyclization/alkenylation reaction of 2-alkynylanilines with 1,3-dicarbonyl compounds. The reactions accomplished the formation of the corresponding 3-alkenylindoles in 90 and 88% yields, respectively (Scheme 17).

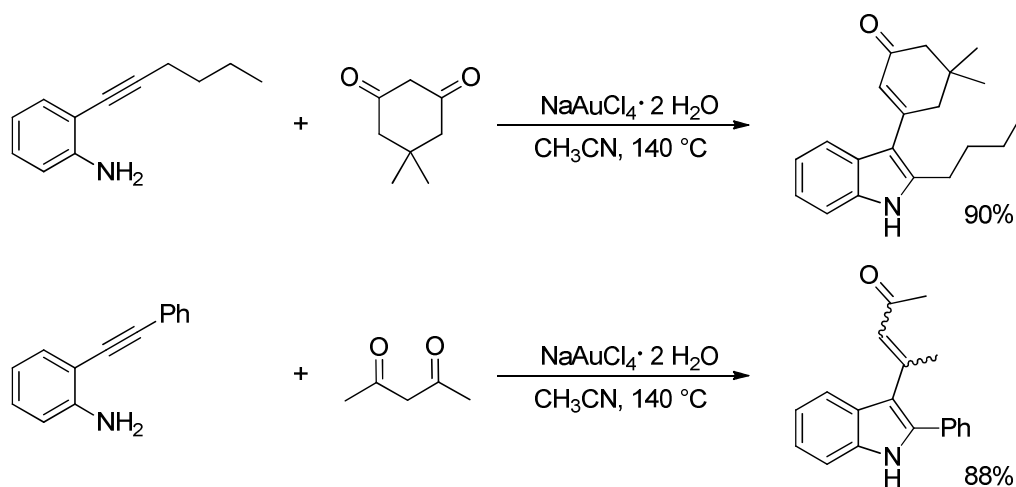

Scheme 17

4. Hydroheteroarylation of carbon–carbon multiple bonds

Direct hydroheteroarylation of carbon–carbon multiple bonds is a highly attractive reaction in organic synthesis. Such a procedure, avoiding functionalization of the starting compound, represents an economically and environmentally benign methodology. α,β -Unsaturated carbonyl compounds/carboxylic acid derivatives, that is activated alkenes and alkynes, are valuable substrates because of the affinity of gold salts and complexes towards carbon–carbon multiple bonds as well as to the carbonyl oxygen.

Milestone works in this field were published by Hashmi and coworkers in 2000^{31b} and Reetz and Sommer in 2003.³³ In accordance with those seminal papers, the electrophilic attack of the gold catalyst,

especially Au(III), to the arene, affording arylgold intermediates is likely. However, Lewis acid activation of the carbonyl group cannot be excluded *a priori*, as well as the peculiar π -activation of gold catalysts. Catalysts involved in hydroarylation reactions are prominently Au(III) species. Enantioselective reactions remain a still unexplored issue in this field.

In the following, the matter is organized according to the nature of the unsaturated substrates.

4.1. Hydroheteroarylation of activated alkenes and alkynes

Indole is the prototype of the electron-rich heteroarenes and has been the most explored heterocyclic nucleus in hydroarylation reactions. Classically, the unsubstituted C-3 position acts as the nucleophilic centre. He and coworkers developed an AuCl₃-catalyzed hydroarylation of several electron-deficient olefins.³⁴ Acrylic acid and acrylonitrile were less effective than acroleine, crotonaldehyde and methyl vinyl ketone, which generally afforded higher yields of the corresponding products (Scheme 18).

The Hashmi group widened the scope of this reaction to 4- and 5-bromoindole using NaAuCl₄·2H₂O (5 mol%) and acroleine affording the Michael adduct in 75 and 67% yield, respectively.³⁵

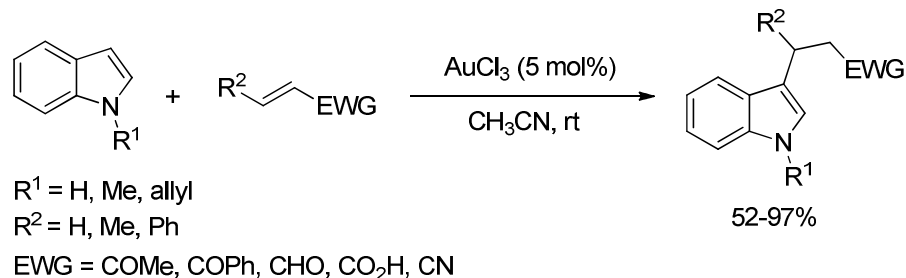

Scheme 18

Also propiolates represent effective Michael acceptors and can be exploited to perform hydroarylation reactions. He and coworkers³⁴ reported the reaction of ethyl propiolate with 2 equivalents of *N*-methylindole and benzofuran in acetonitrile. Surprisingly, the reaction yielded only the double addition products (Scheme 19). These results may indicate that the first hydroarylation reaction gives an activated alkene, which reacts faster with the second equivalent of arene to afford the bis-substituted product.

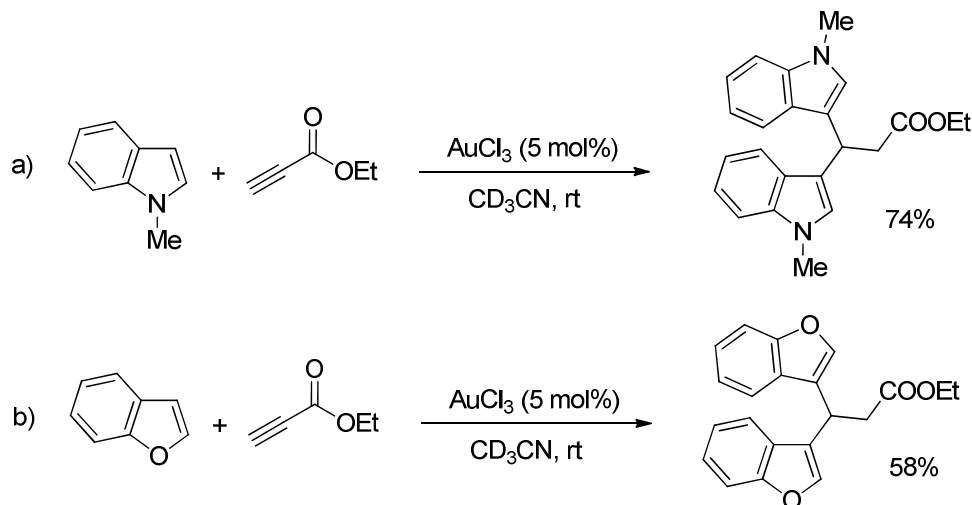

Scheme 19

An interesting intramolecular hydroarylation between furan and an α -ketoalkyne was reported by Menon and Banwell in 2010.³⁶ This reaction represented one of the steps toward the total syntheses of crassifolone and dihydrocrassifolone (Scheme 20). The Echavarren gold(I) catalyst was exploited by the authors to afford the desired compound in quantitative yield.

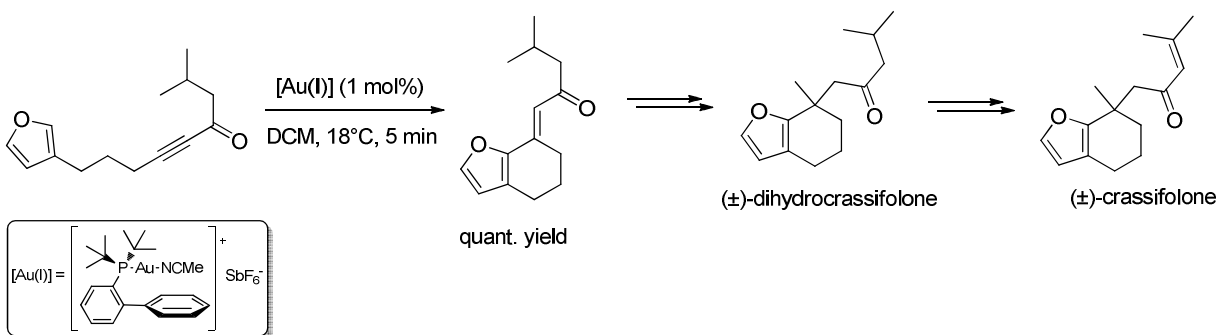

Scheme 20

Arcadi and coworkers tried to control the regioselectivity of $\text{NaAuCl}_4 \cdot 2\text{H}_2\text{O}$ -catalyzed addition of several 7-azaindoles to α,β -enones.³⁷ Unfortunately, N-1 and C-3 alkylation products were formed and their ratio depended on the nature of both reaction partners. In general, the reaction required harsh conditions: ethanol heated at 100 °C for 24 hours with 5 mol% of the catalyst in the case of more reactive substrates (Scheme 21).

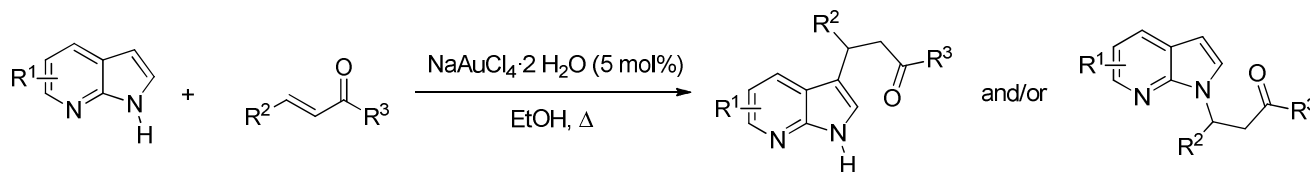

Scheme 21

The previous papers reported the use of a slight excess of the Michael acceptor. Interestingly, Nair and coworkers described that a reaction performed with a 3:1 ratio between indole and crotonaldehyde yielded the tri-addition product reported in Scheme 22.³⁸ The authors hypothesized the formation of an arylgold species as primary reaction intermediate, then a 1,4-addition followed by a 1,2-addition and a S_N reaction led to the formation of the final product. Both indole and *N*-methylindole participate to the reaction.

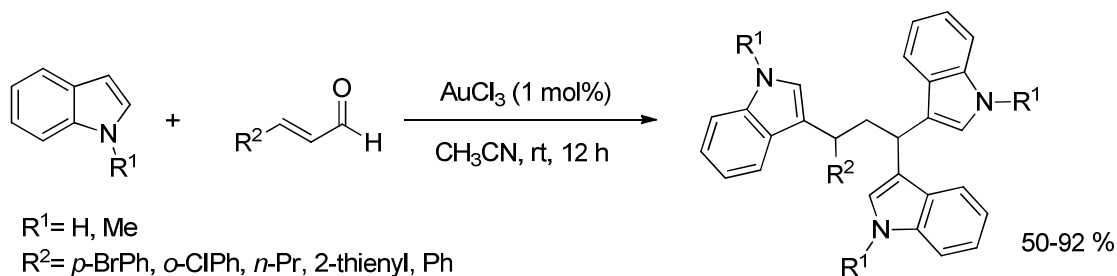

Scheme 22

Hashmi and coworkers³⁵ reported an in-depth analysis of the gold catalyzed addition of pyrroles to methyl vinyl ketone. The standard reaction conditions envisaged the catalysis of $\text{NaAuCl}_4 \cdot 2\text{H}_2\text{O}$ at a molar ratio of 5 mol% in acetonitrile at room temperature. The alkylation takes place at both unsubstituted

positions 2 and 5, independently on the protecting group at the nitrogen atom (Scheme 23a). Electron-withdrawing 2-substituted pyrroles yielded again a doubly alkylated product, this time at the positions 4 and 5 (Scheme 23b). A pyrrole with an electron-withdrawing group in 3 afforded both tri- and tetrasubstituted systems with a ratio depending on catalyst and stoichiometry (Scheme 23c).

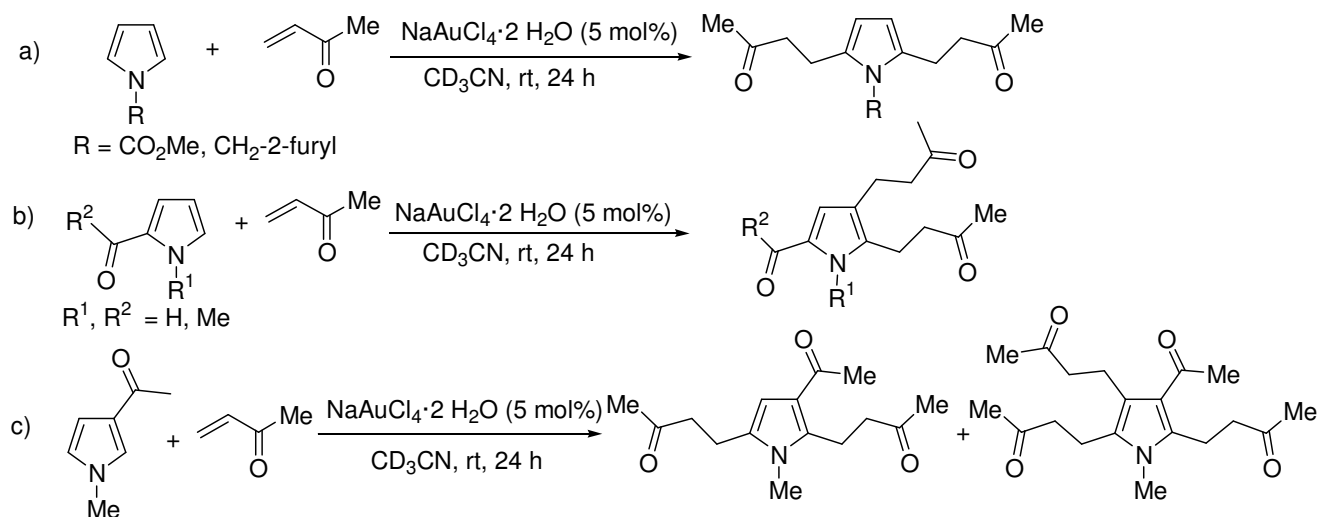

Scheme 23

Furan and benzofuran derivatives have been less explored than the analogues nitrogen-containing heterocycles, mainly because of regioselectivity issues. He and coworkers³⁴ reported four examples of hydroarylation of α,β -unsaturated ketones and aldehydes with oxygenated heterocycles. Benzofuran as well as 2-methylfuran afforded only the product at the free α -position (Scheme 24a). On the other hand, furan did not show selectivity and the double adduct was the main product (Scheme 24b).

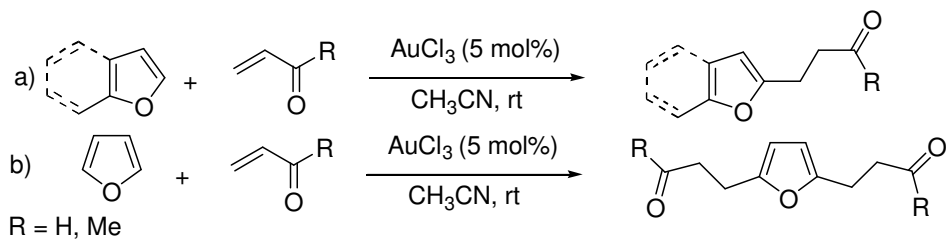

Scheme 24

The gold catalyzed addition of α,β -unsaturated aldehydes to indoles developed by Nair group (see Scheme 22), was also extended to 2-methylfuran³⁸ (Scheme 25). This nucleus showed a reactivity comparable to indole.

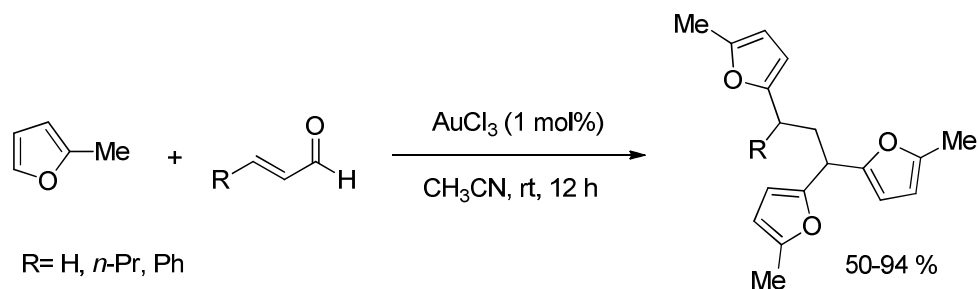

Scheme 25

Contel, Urriolabeitia and coworkers tested a gold(III) iminophosphorane complex in the addition of 2-methylfuran to methyl vinyl ketone.³⁹ The catalyst afforded the desired product in 92% yield (Scheme 26). The same authors reported in 2009 the synthesis of a second generation of moisture stable Au(III)-iminophosphorane complexes.⁴⁰ The new catalysts gave slightly worse yields (Scheme 26).

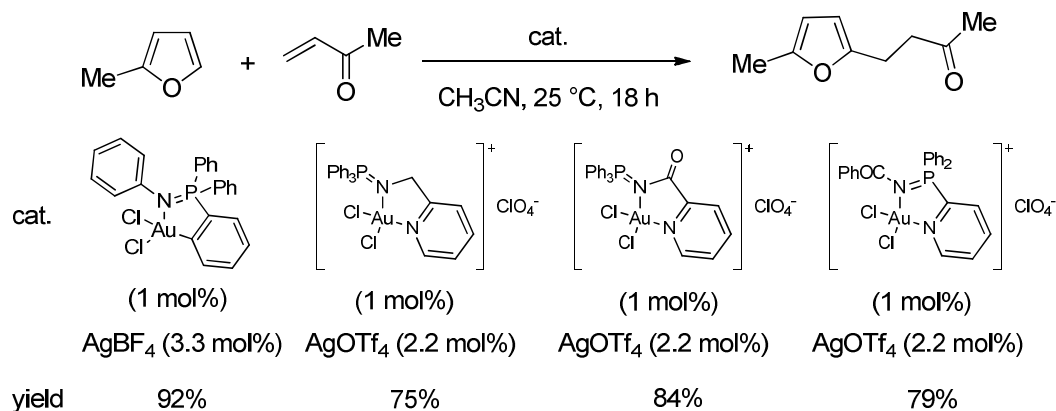

Scheme 26

4.2. Hydroheteroarylation of unactivated alkenes

Intermolecular hydroarylation of alkenes is a useful approach for functionalization of arenes. Transition metal-catalyzed hydroarylation of alkenes is of particular importance due to its high selectivity, synthetic efficiency and environmental friendliness.

Che and coworkers reported an efficient intermolecular hydroarylation of unactivated alkenes with indoles using the system $[(\text{PPh}_3)\text{AuCl}]/\text{AgOTf}$ as catalyst.⁴¹ First, the authors examined the coupling reaction between *N*-methyl-indole and *p*-methylstyrene (Scheme 27).

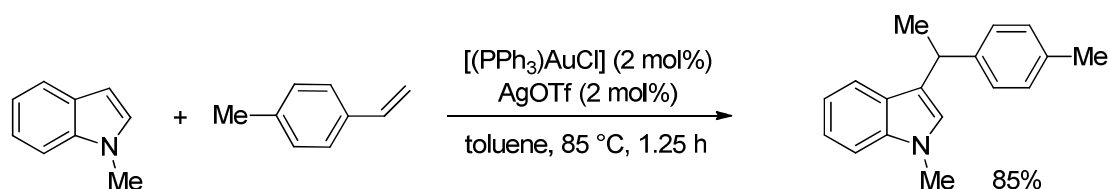

Scheme 27

The gold(I) catalyzed reactions of indoles with aryl alkenes were achieved in toluene at 85 °C over a reaction time of 1–3 hours with 2 mol% of $[(\text{PPh}_3)\text{AuCl}]/\text{AgOTf}$ as catalyst. This method works for a variety of styrenes bearing electron-deficient, electron-rich and sterically bulky substituents to give the corresponding products in good to high yields (60–95%). No product was found when unactivated aliphatic alkenes were treated under the reaction conditions described above but, under microwave irradiation, coupling with indoles gave the corresponding adducts in up to 90% yield. These reactions were achieved in dichloroethane with microwave irradiation (43 W, 5–30 minutes, 130–140 °C) and 5 mol% of $[(\text{PPh}_3)\text{AuCl}]/\text{AgOTf}$ as catalyst. The authors examined coupling of indoles with different electronic properties and various unactivated aliphatic cycloalkenes and conjugated dienes. Selective hydroarylation of terminal C=C bond of conjugated dienes gave good product yields (62–81%). On the basis of deuterium-labelling experiments, a reaction mechanism for the hydroarylation of styrenes with indoles is proposed.

The C=C bond of an alkene coordinated to cationic $[\text{Au}(\text{PPh}_3)]^+$ is attacked by nucleophilic indole to give a gold complex intermediate that undergoes subsequent protonolysis at the Au-C bond to give the desired coupling product (Scheme 28).

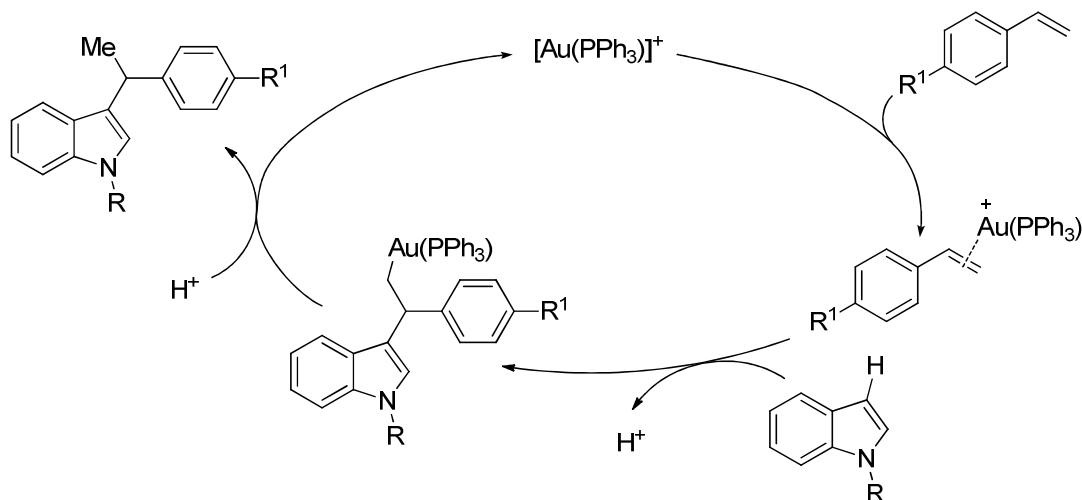

Scheme 28

In 2009, the same research group developed a highly efficient gold(III) catalyzed intermolecular hydroarylation of unactivated alkenes with arenes or heteroarenes (for example, thiophene ring) and extended the substrate scope of alkenes to those having different steric and electronic properties.⁴² The best reaction conditions were: 5 mol% of AuCl_3 and 15 mol% of AgSbF_6 at 50 °C in dichloroethane for 5 hours (with product yields up to 98% and good regioselectivities).

4.3. Hydroheteroarylation of allenes

The C=C π -bond of allenes is ~ 10 kcal/mol less stable than the C=C π -bond of a simple alkene. For this reason, the transition metal catalyzed hydrofunctionalization of allenes with carbon and heteroatom nucleophiles has been investigated as a mean to circumvent some of the difficulties associated with catalytic alkene hydrofunctionalization. However the *exo*-functionalization of allenes with carbon and heteroatom nucleophiles remains problematic.

In 2009, Widenhofer and coworkers reported the intermolecular hydroarylation of monosubstituted, 1,3-disubstituted and tetrasubstituted allenes with various indoles catalyzed by a 1:1 mixture of a gold(I) *N*-heterocyclic carbene complex and AgOTf at room temperature with formation of 3-allyl-indoles⁴³ (Scheme 29).

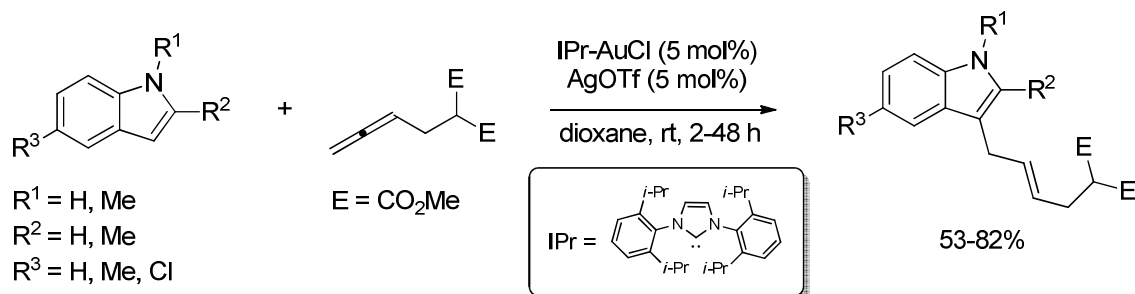

Scheme 29

1,3-Disubstituted allenes underwent gold(I) catalyzed hydroarylation from the corresponding 3-(2-alkene-1-yl)indoles with excellent diastereoselectivity. In the case of differently disubstituted allenes, the regioselectivity of hydroarylation was affected by both the electronic and steric nature of the allenyl substituents. The mechanism of the reaction mirrors that of the related hydroalkoxylation and hydroamination processes.⁴⁴ Halide abstraction from IPrAuCl with AgOTf generates the active catalyst IPrAuOTf that presumably undergoes displacement of the triflate ligand with allene to generate an equilibrating mixture of gold π -allene complexes **A** and **A'** (Scheme 30).

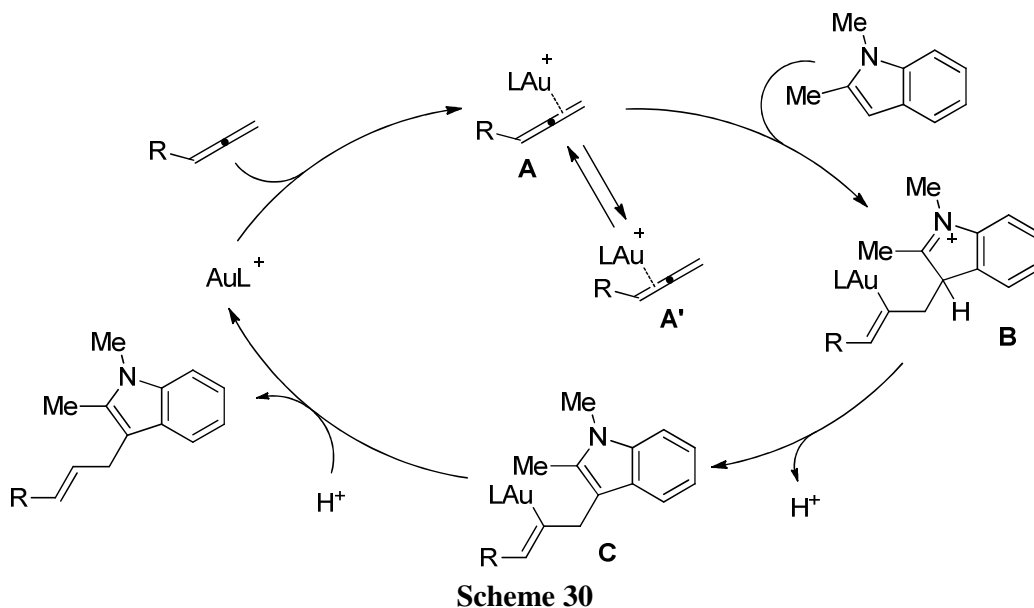

Outer-sphere attack of the indole on the gold allene complex **A** in which gold is positioned *cis* to the proximal alkyl group would form iminium ion **B**. Deprotonation of **B**, followed by protonolysis of the Au–C bond of neutral gold vinyl species **C**, would release the alkylated indole and regenerate the cationic gold NHC complex.

The same research group contributed also to develop some protocols for the intramolecular *exo*-cyclization of functionalized 2-allenylindoles,⁴⁵ catalyzed by a 1:1 mixture of Au[P(*t*-Bu)₂(*o*-biphenyl)]Cl and AgOTf (5 mol%) to give functionalized tricyclic indole derivatives (Scheme 31).

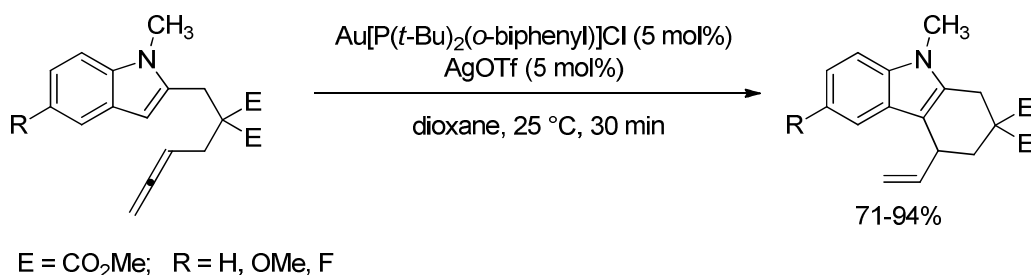

The protocol tolerated substitution at either the internal or terminal allenyl carbon atom. Allenyl indoles that possessed an axially chiral allenyl moiety underwent cyclization with transfer of chirality from the allene to the newly formed stereogenic carbon atom and with selective formation of the *E*-alkene.

Widenhoefer and coworkers also developed enantioselective transformations catalyzed by chiral bis(gold) complexes of the form (P-P)Au₂X₂(P-P)=bidentate phosphine (X=anionic ligand or counterion).⁴⁶ The gold(I) catalyzed enantioselective hydroarylation of 2-allenylindoles to form functionalized tricyclic indole derivatives was achieved using a catalytic 1:2 mixture of [(S)-3,5-*t*-Bu-4-MeO-MeOBIPHEP]Au₂Cl₂ and AgBF₄ in toluene at -10 °C for 18–24 hours (Scheme 32). The tetrahydro-carbazole was isolated in high yield and in modest to good *e.e.* (determined by chiral HPLC analysis) but the absolute configuration of the product was not determined.

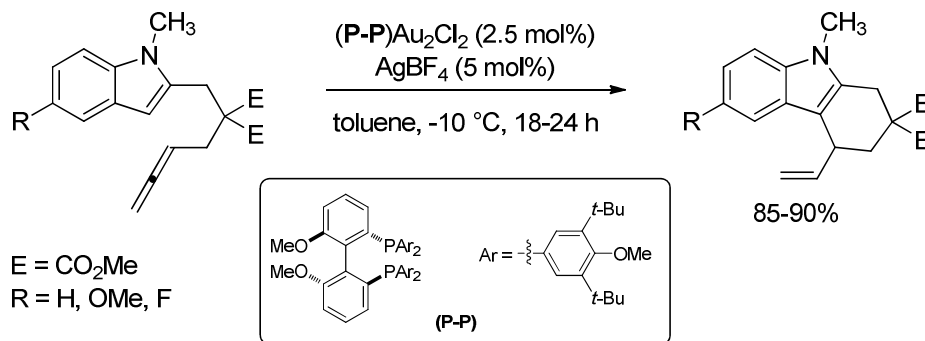

The protocol tolerated free hydroxyl group in proximity to the allenyl moiety, but again with modest enantioselectivity, and was effective for the cyclization of terminally disubstituted allenes and for the formation of seven-membered rings. The stereoselectivity of hydroarylation was controlled predominantly by the substrate stereocentre(s).

Recently, Alcaide, Almendros and coworkers presented the Au-catalyzed 6-*endo* carbocyclization/functionalization (with concomitant dehydration) of 2-indolyl allenols, as an efficient synthetic tool to obtain added-value compounds, such as carbazole derivatives⁴⁷ (Scheme 33). AuCl was selected as the gold source. The reactions were found to proceed with complete chemoselectivity control (carbocyclization *vs* oxycyclization *vs* azacyclization).



The carbazole formation must be driven by the higher stability associated with the aromatic six-membered carbocycle formed through the 6-*endo* carbocyclization reaction. A possible pathway may initially involve the formation of the complex **A** by coordination of gold chloride to the distal allenyl double bond (Scheme 34). Next, chemo- and regio-selective 6-*endo* carboauration forms the iminium ion **B**. Loss of HCl generates the neutral specie **C**, which, after protonolysis of the carbon–gold bond and dehydration, affords carbazole with concurrent regeneration of the gold catalyst.

In 2010, Barluenga and coworkers presented well-defined examples of a catalytic allene hydroarylation following the 6-*endo* cyclization mode.⁴⁸ The methodology was applied in a straightforward

synthesis of the relevant 6,9-dihydro-pyrido[1,2-*a*]-1*H*-indole core. The ancillary ligand selected was di-*tert*-butyl(*ortho*-biphenyl)phosphine [P(*t*-Bu)₂(*o*-biphenyl), JOHNPHOS] and bis(trifluoromethanesulfonyl)-imidate (NTf₂) was the best counteranion for gold(I) (Scheme 35). The cyclization was also efficient for an internal allene.

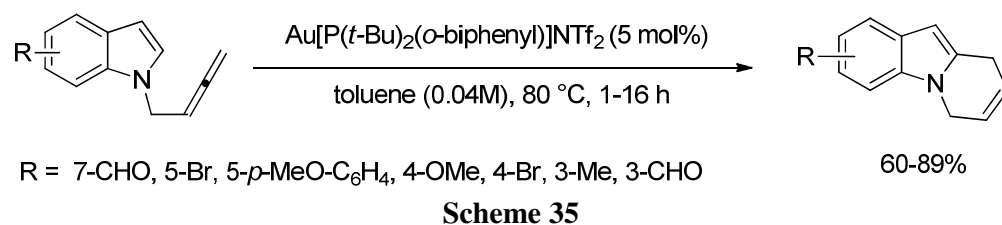
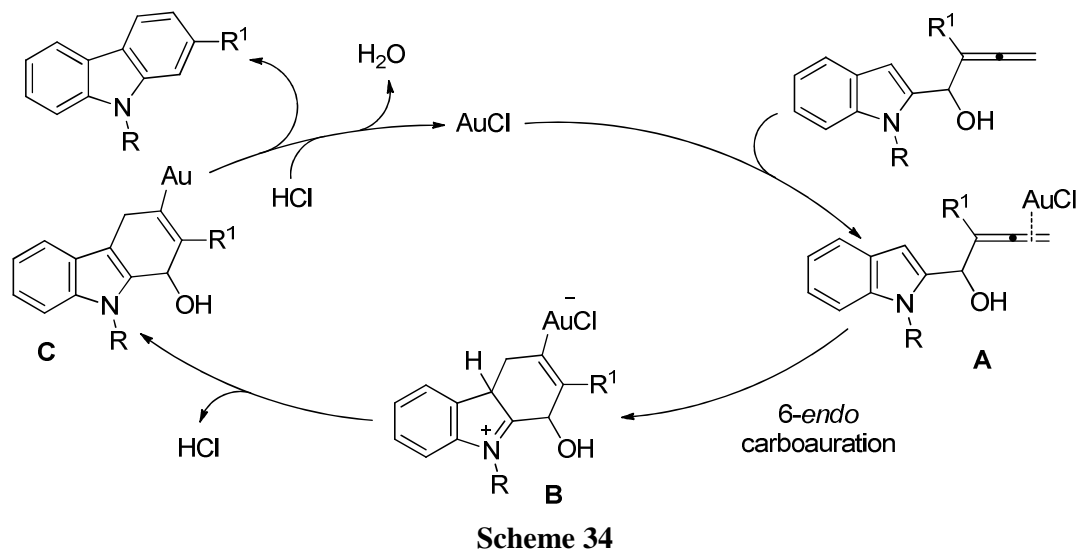

Substitution at C-2 in the indole moiety precludes the cyclization to occur and rather, a careful control over the reaction conditions drives an interesting cyclotrimerization reaction furnishing macrocyclic compounds. Additional experiments with 2-deutero derivatives, besides confirming the key role of the C-2 substituent, gave insight into the mechanism of the hydroarylation reaction (Scheme 36).

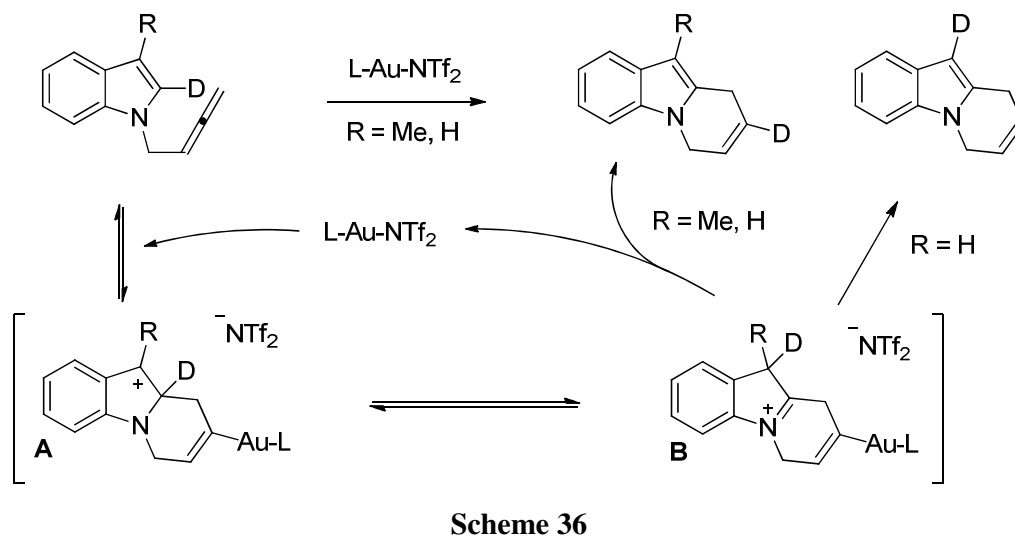

The initial interaction of Au^+ with the allene gives the π -complex, then cyclization occurs at the C-2, even when the C-3 position is unsubstituted, because of the high strain associated with cyclization at C-3. Hence, the intermediate **A** is formed and subsequently undergoes rearrangement to give the more stable iminium ion **B** by deuteride ion migration. Then, rearomatization of the five-membered ring gives the products with the observed deuterium distribution.

Toste and Zeldin described the application of a gold(I) catalyzed hydroheteroarylation to the total synthesis of flinderoles **B** and **C**, which are members of a new class of antimalarial bisindole alkaloids isolated from plants of the *Flindersia* genus⁴⁹ (Scheme 37).

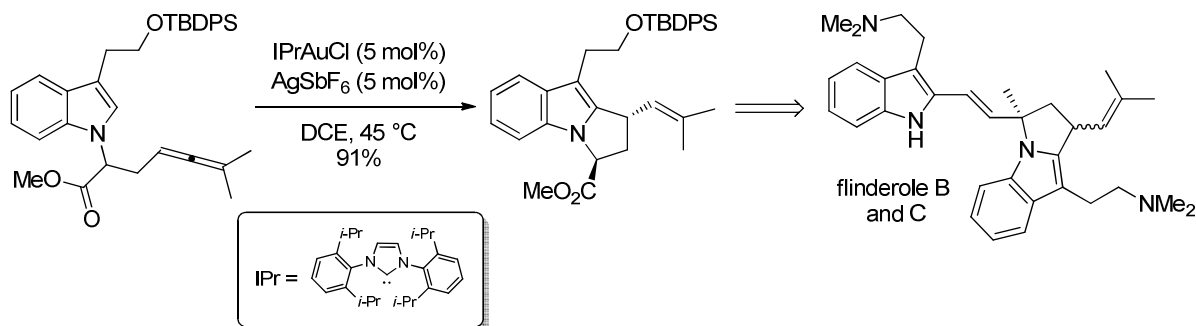

Scheme 37

Initial attempts to achieve the key carboauration step by using 5 mol% triphenylphosphine gold(I) as the catalyst failed to elicit cyclization of the starting allene. By moving to more electropositive *N*-heterocyclic carbene catalyst IPrAuSbF_6 , the authors obtained the desired pyrrolidine derivative as a single diastereoisomer in 91% yield.

4.4. Hydroheteroarylation of unactivated alkynes

Gold catalysts can be considered as powerful soft Lewis acids for the activation of C–C triple bonds toward nucleophilic attack. The hydroarylation of alkynes (or alkenylation of arenes) catalyzed by electrophilic transition-metal complexes has emerged as a valuable method for the synthesis of alkenyl arenes and heteroarenes.

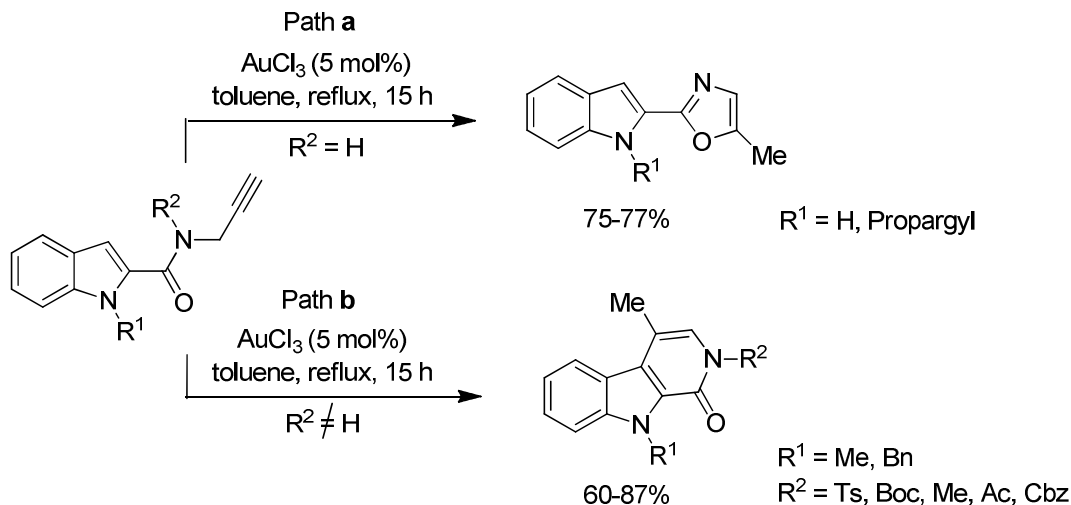

Scheme 38

Padwa and coworkers⁵⁰ reported a highly efficient route toward various lavendamycin analogous utilizing a AuCl₃ catalyzed intramolecular cycloisomerization of *N*-propargyl indole-2-carboxamides (Scheme 38).

The initial activation of the triple bond by the electrophilic metal species is followed by two possible modes of cycloisomerization depending on the nature of the R² substituent (Scheme 39). In the case where R²=H, backside attack by the amide carbonyl group on the π -coordinated alkyne complex **A** *via* path a would eventually produce oxazole by protodemetalation of the aurated enol ether species **B** followed by a subsequent isomerization of a transient 5-methylene-substituted 4,5-dihydrooxazole **C**. This type of reactivity has been described by both Hashmi⁵¹ and Echavarren.^{2g,52} However, if the amido nitrogen atom contains a substituent other than hydrogen, a 6-*exo-dig* cyclization reaction would occur by attack of the C-3 position of the indole ring *via* path b. Following protodemetalation of **D** and isomerization of **E**, carbolinone would be produced. The resulting β -carbolinone system was used for subsequent cross-coupling chemistry.

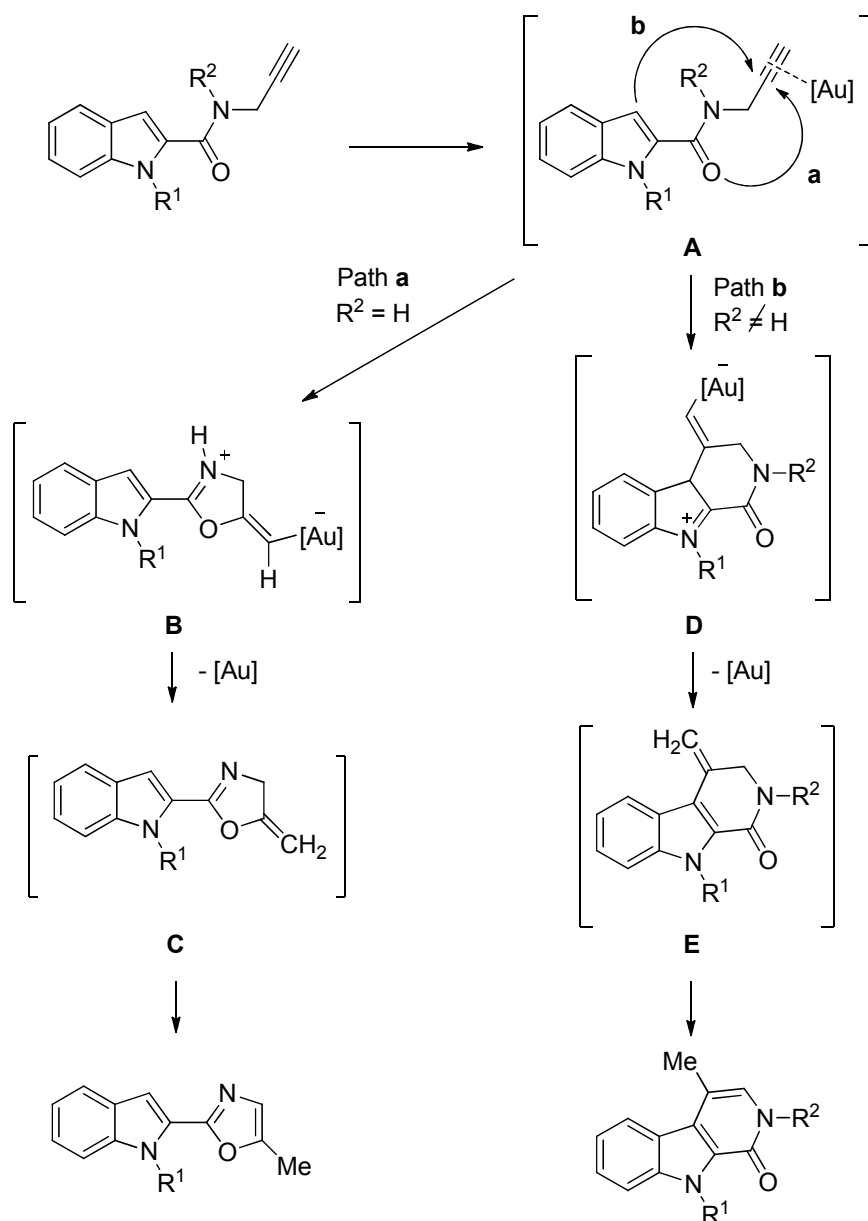

Scheme 39

Complementary, Beller and coworkers⁵³ envisioned the synthesis of pyrroloazepinone derivatives based on the catalytic intramolecular cyclizations of alkyne-substituted pyrrolicarboxamides. According to the work of Echavarren,^{2g,52} the best catalyst for the formation of the seven-membered ring should be an Au(III) complex and the expected product the pyrrolo[2,3-*c*]azepin-8-one formed by an *7-endo-dig* process. Surprisingly, the authors obtained two intramolecular cyclization products: the pyrrolo[2,3-*c*]azepin-8-one and prevalently, the pyrrolo[3,2-*c*]azepin-4-one (Scheme 40).

Full conversion was observed in the presence of either H₂PtCl₆·6H₂O, K₂PtCl₆ or PtCl₂ (COD) as catalyst in toluene at 120 °C, while the AuCl₃ catalyzed reactions led to lower yields. After investigation on the influence of increased temperature on the reaction outcome, it appears that the gold catalyst was temperature sensitive and more quickly deactivated compared to the platinum system. Apart from Pt and Au, other metal catalysts tested showed no activity for the cyclization process.

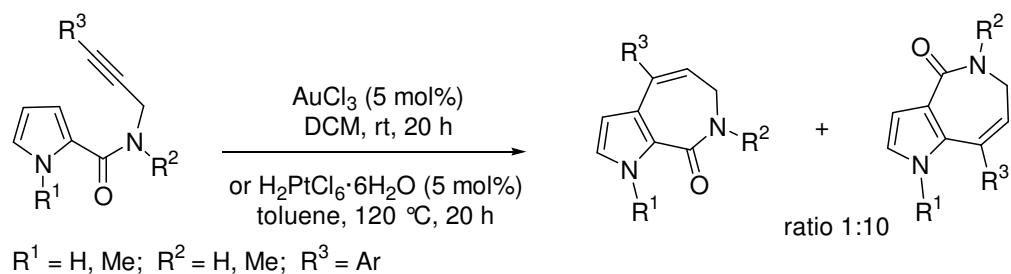

Scheme 40

Thus, in agreement with earlier reports in the literature,^{2g,50,52} the pyrrole-substituted alkyne should be activated at the triple bond by coordination to the electrophilic Au(III), Pt(IV) or Pt(II) catalysts.

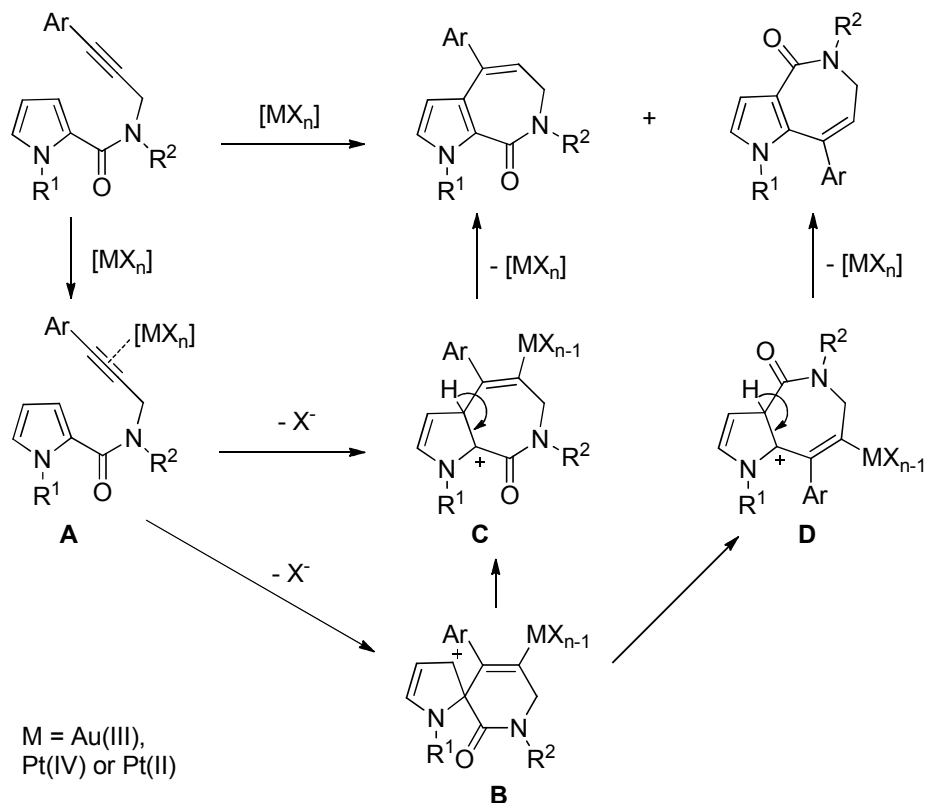

Scheme 41

Then, several modes of cycloisomerizations are possible depending on the reaction conditions. Following the initial activation of the triple bond, cation **C** is formed either directly from intermediate **A** or *via* cation **B**. Subsequent protonolysis of the carbon–metal bond and deprotonation leads to pyrrolo[2,3-*c*]azepin-8-one. On the other hand, the reactive spiro intermediate **B** might form cation **D** by rearrangement, which after deprotonation followed by demetalation, provides the pyrrolo[3,2-*c*]azepin-4-one (Scheme 41).

Gevorgyan and Seregin⁵⁴ developed a mild cascade cycloisomerization of propargyl *N*-containing heterocycles into various types of *N*-fused pyrroloheterocycles in the presence of Au(I) or Au(III) salts. This cycloisomerization appeared to be general with regard to the heterocyclic core: pyridine, isoquinoline, quinoxaline, pyrazine and thiazole reacted smoothly in good to excellent yields (Scheme 42).

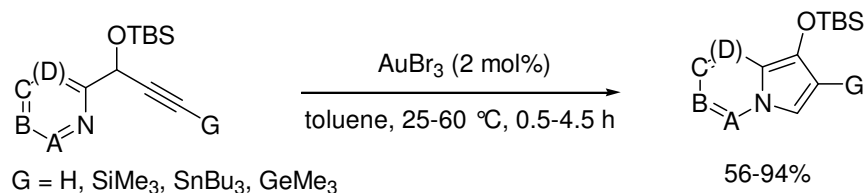

Scheme 42

The reaction proceeds *via* alkyne-vinylidene isomerization with concomitant 1,2-migration of H, silyl, and stannyl groups, as well as previously unknown 1,2-migration of a germyl group, giving easy access to a variety of C-2 functionalized heterocycles. First, isomerization of alkyne results in the formation of vinylidene **A**, followed by nucleophilic attack of the nitrogen lone pair at the vinylidene carbon, resulting in formation of zwitterion **B**. The latter can undergo a series of 1,2-hydride shifts to furnish the final product (Scheme 43). The proposed mechanism was supported by a deuterium-labeling experiment performed using an isotopically homogeneous propargyl pyridine.

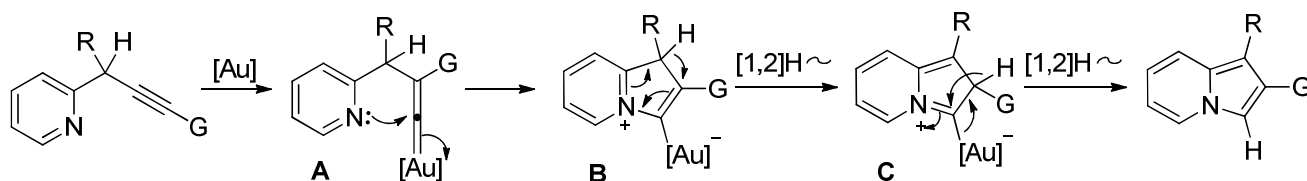

Scheme 43

Barluenga and coworkers developed a new site-selective double hydroheteroarylation reaction of alkynes catalyzed by gold complexes and directed by an internal hydroxyl group.⁵⁵ The treatment of 3-butyn-1-ol derivatives with indole (2 equiv.) and a catalytic amount of an *in situ* formed cationic gold complex ($[(\text{Ph}_3\text{P})\text{Au}]^+\text{SbF}_6^-$) led to the formation of bis(indolyl)alkanols (Scheme 44).

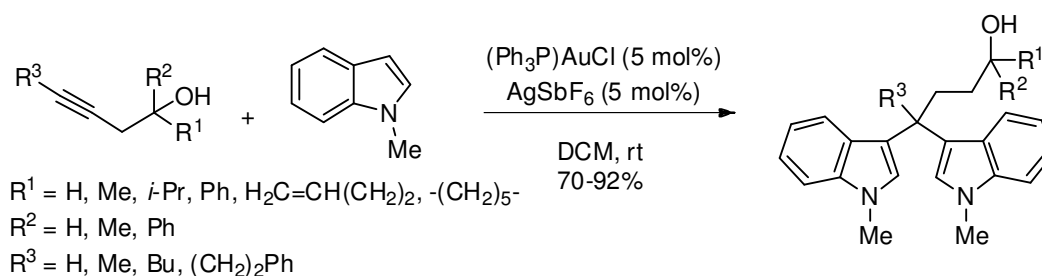

Scheme 44

The products were obtained as single regioisomers. When terminal alkynes were used, the double addition of the indole occurred at the terminal carbon of the triple bond. When internal alkynes were used, the double addition occurred at the carbon distal to free hydroxyl group (Scheme 45). The first step of the catalytic cycle is the coordination of the metallic complex to the triple bond of the starting alkynol to form the intermediate **A**. Intramolecular addition of the hydroxyl group to the terminal carbon of the triple bond generates **B**. Protodemetalation of the latter affords the enol ether **C** and releases the catalytic species. After an initial coordination of the catalyst to the double bond of the enol ether **C**, the oxonium intermediate **D** is formed. Further nucleophilic attack of the indole affords the intermediate **E** that evolves through aromatization and protodemetalation to give the tetrahydrofuran derivative **F**. The role of **F** as an intermediate of the reaction is supported by an experiment where the compound was isolated and characterized. Coordination of the gold cation to the oxygen of **F** favours the opening of the tetrahydrofuran ring to form the intermediate **G**. A second nucleophilic attack of the indole affords the intermediate **H** that, after aromatization by deprotonation and protodemetalation steps, gives rise to the final product releasing the catalytic species.

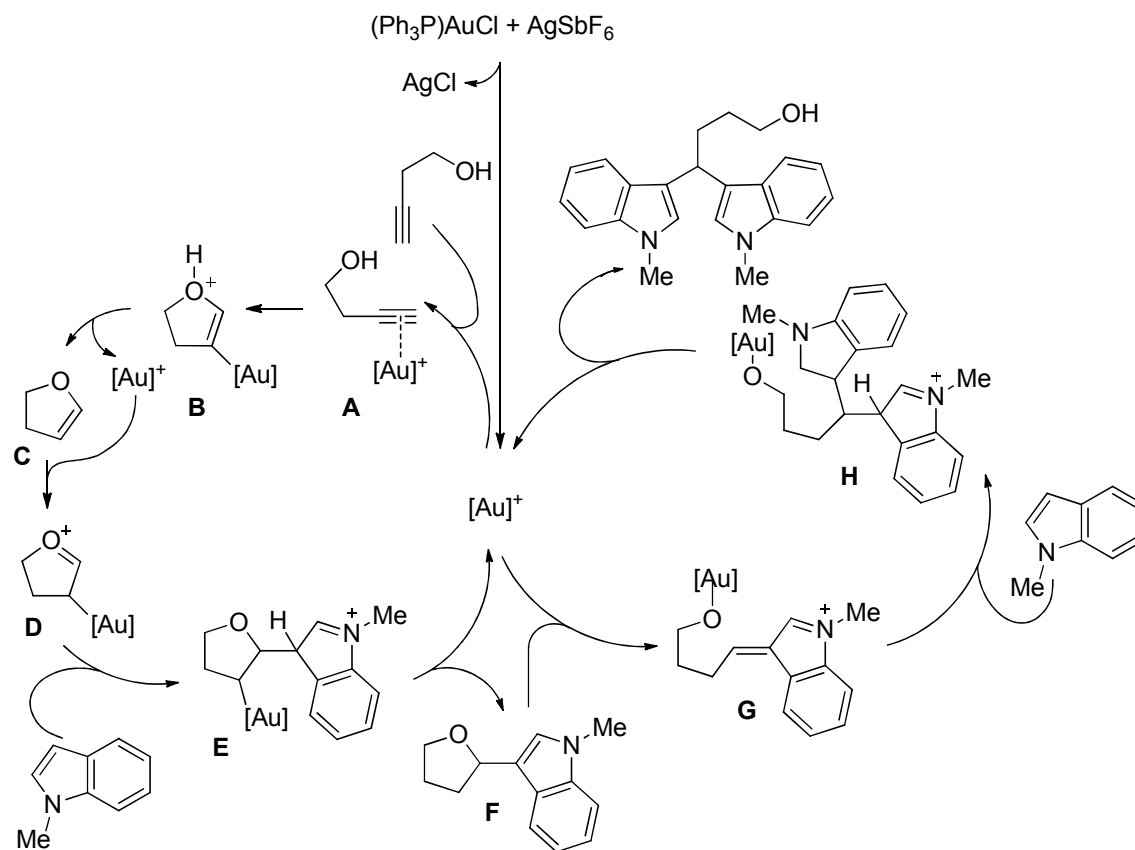

Recently, Perumal and Praveen were interested in the cyclization of 2-substituted indoles and developed a new synthetic protocol for carbazoles through gold(I) catalyzed intramolecular hydroarylation of (*Z*)-2-(enynyl)indoles (Scheme 46).⁵⁶ Experiments performed on a mixture of *Z*- and *E*-isomers under the previously optimized gold catalyzed cyclization conditions showed that only the *Z*-isomer underwent cyclization (the *E*-isomer was recovered quantitatively). Hence, the authors envisaged a stereoselective synthesis of (*Z*)-2-(enynyl)indoles after long reaction times. Starting materials with a wide range of alkyl

substituents on the indole nitrogen as well as on the alkyne functionality gave good yields of product. Alkynes possessing aryl groups resulted in only moderate yield of products even after a long reaction time.

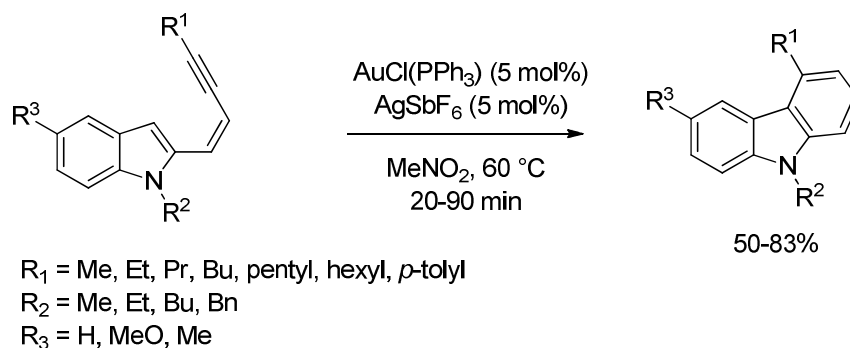

Scheme 46

A possible mechanism explaining the formation of carbazole involves activation of the alkyne by the gold catalyst to form the complex **A**. Subsequent nucleophilic attack of the C-3 carbon of indole leads to the 6-*endo-dig* intermediate **B**. The latter species, upon proto-deauration, results in the formation of carbazole (Scheme 47).

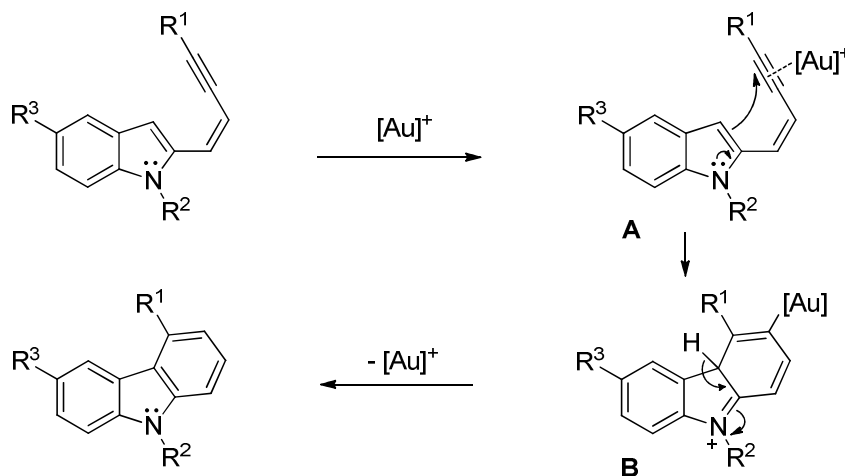

Scheme 47

Tu and coworkers⁵⁷ have developed a gold catalyzed regiodivergent annulation of alkynyl indoles tuned by a protective group on the indoles (Scheme 48).

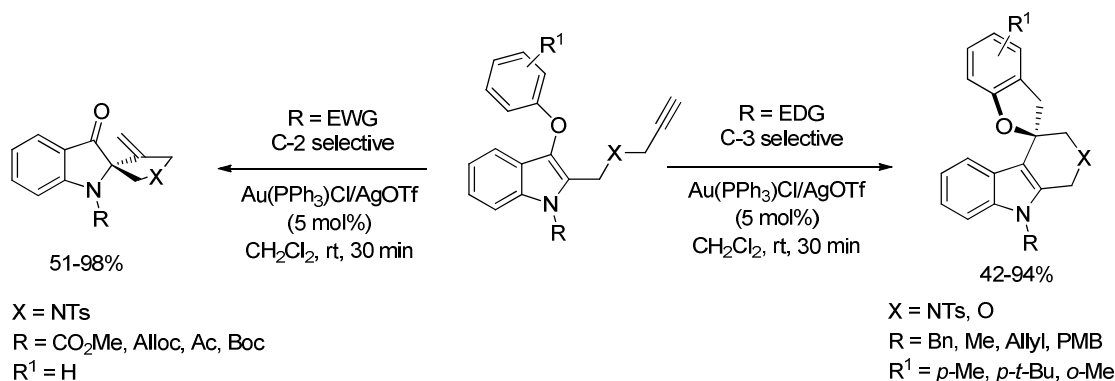

Scheme 48

With an electron-donating protective group, C-3 selective annulation took place and gave structurally interesting spiro-THBC (tetrahydro- β -carboline) derivatives. In contrast, with electron-withdrawing protective groups, C-2 selective annulations occurred and afforded a synthetically useful spiro-pseudoindoxyl structure. A series of gold and platinum catalysts were screened; the use of Au(PPh₃)Cl/AgOTf (5 mol%) in CH₂Cl₂ at room temperature within 30 minutes gave the best results for either the *N*-EDG or *N*-EWG substrates with high yields after short reaction times.

The two different reaction pathways start from the common intermediate complex **A**, in which both the C-2 and C-3 carbons display nucleophilic properties owing to the presence of electron-donating heteroatoms in both positions (Scheme 49).

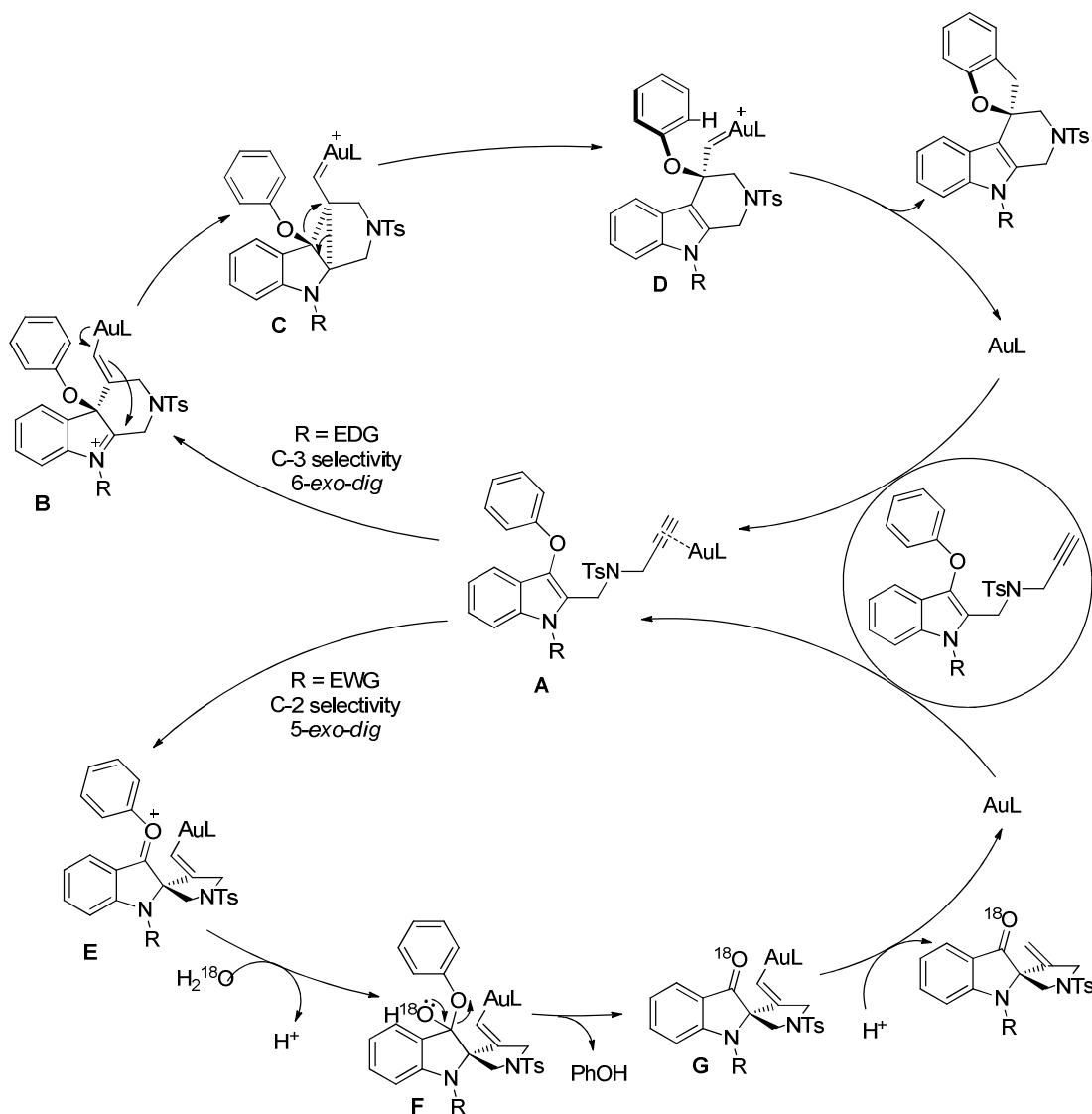

Scheme 49

When R was an EDG, the more reactive C-3 centre underwent nucleophilic addition to the triple bond by a 6-*exo-dig* cyclization pathway, resulting in Friedel-Crafts alkenylation of the indole nucleus to give the intermediate **B**. Next, the alkenyl gold species underwent an intramolecular nucleophilic attack on the iminium cation to generate the gold cyclopropyl carbene intermediate **C**. Subsequent rearomatization *via* an

unusual 1,2 migration of a phenoxy group along with the opening of the cyclopropyl ring afforded intermediate **D**. Finally, **D** underwent a Friedel-Crafts reaction to give the product and the release of AuL for the next catalytic cycle. In contrast, using an EWG to reduce C-3 reactivity, along with the efficiency of the installed phenoxy group at the C-3 site to enhance C-2 reactivity, the nucleophilic addition of **A** took place at the C-2 centre to give the spirocyclic intermediate **E** with an oxacarbenium at the C-3 site. **E** was quenched by water in the reaction system to form hemiketal **F**. Subsequently, **F** lost a molecule of phenol and afforded the pseudoindoxyl intermediate **G**. Finally, protodemetalation of **G** delivered the product and the catalyst AuL.

A new Au(I)-catalyzed synthesis of functionalized tetracyclic indolines has been recently described by Wang and coworkers.⁵⁸ The approach is a highly diastereoselective tandem cyclization that allows the assembly of two rings and two stereocentres including a quaternary carbon in a single step with a wide substrate scope (Scheme 50). The reaction implies a 6-*exo-dig* cyclization by nucleophilic attack of indole C-3 to gold activated triple bond followed by intramolecular addition of the tethered nucleophile to the iminium ion. The mechanism was also studied at theoretical level.⁵⁹ It is worth to note that the stereochemistry at the two quaternary centres is controlled solely by the stereochemistry of the tethered nucleophile.

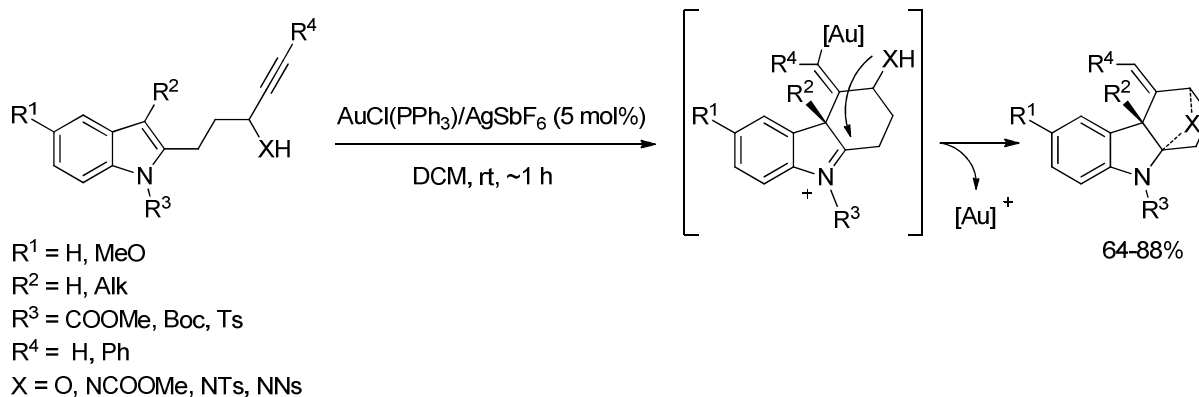

Scheme 50

No other regioisomers or diastereoisomers were identified from the reaction mixtures. The indole nitrogen required an electron-withdrawing substituent, as in the presence of H or Me groups the reaction failed. Alkyl-substituted alkynes did not produce any desired cyclization product. Interestingly, when X was an acetamide, the cyclization products were 5-methylene-4,5-dihydrooxazoles instead of the desired tetracyclic indolines. The approach was extended to triptamines bearing two-carbon linker between the indole and the alkyne. The reactions proceeded smoothly using the same catalyst system in toluene at 60 °C and provided 6-*endo-dig* cyclization products (Scheme 51).

In a similar fashion, Bandini and coworkers reported a gold(I) catalyzed tandem approach to tetracyclic indolines starting from readily available unprotected (NH)-indole propargyl alcohols (Scheme 52).⁶⁰ The catalyst of choice was a preformed cationic gold phosphine complex and SbF_6^- proved to be the best counterion. The reaction proceeded with excellent diastereoisomeric ratio. It is worth noting that the catalyst used by Wang⁵⁸ gave the desired product in a good 68% yield (*cfr.* Scheme 50). Differently from what observed by Wang, the presence of activating EWG groups on the indole nitrogen was not mandatory in this methodology. The authors tentatively rationalized the opposite regiochemistry observed starting from

different chain length alkynols, in terms of intrinsic molecular requisites of the precursors. Thus, while the 6-*endo-dig* mechanism seemed not structurally accessible in the case of hexynols chain ($n=1$), due to the limited length of the side chain, the introduction of longer heptynols chain allowed a 7-*endo-dig* cyclization path.

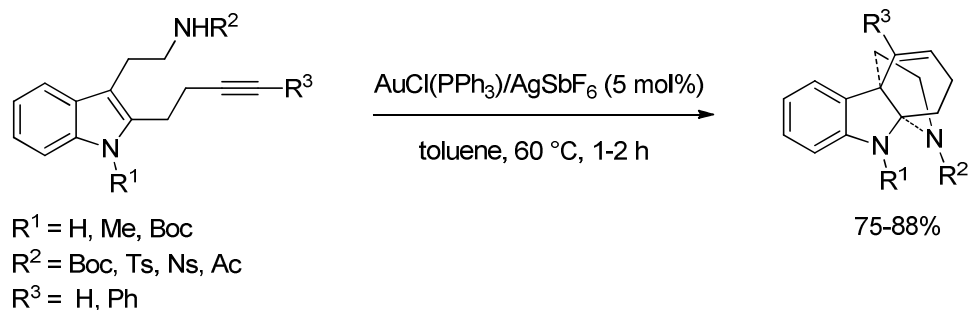

Scheme 51

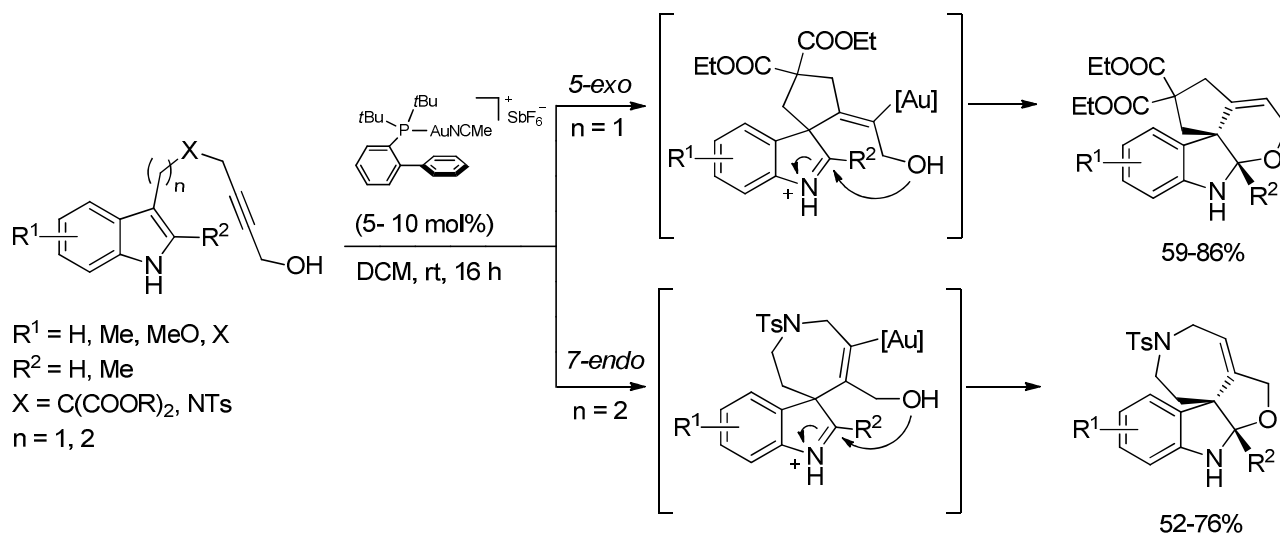

Scheme 52

5. Direct alkynylations

Ethynyl-substituted heterocycles are useful intermediates in synthetic organic chemistry and are valuable motifs in material chemistry. Consequently, synthetic strategies to introduce acetylenic moiety on the heteroaromatic ring are of fundamental importance. Metal catalyzed cross-coupling strategies, typically Sonogashira reaction⁶¹ and recently “inverse Sonogashira reaction”,⁶² are the most widely used (Scheme 53).

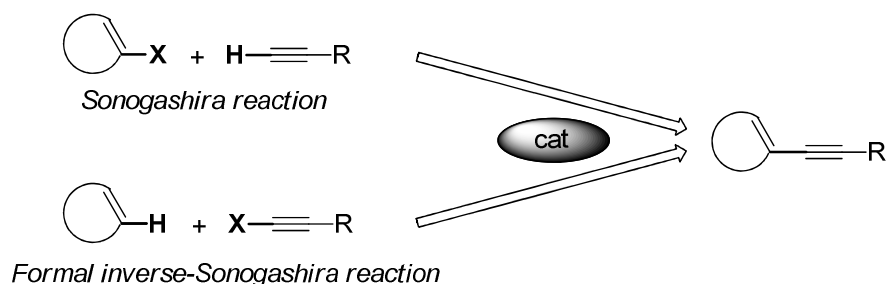

Scheme 53

These approaches have the main drawback that an activate substrate, *i.e.* an halide and/or an organometallic species, is required. It is evident that a direct coupling between a terminal alkyne and an aryl system would be the ideal strategy with regard to atom economy and substrate availability. Therefore, several research groups are focusing their attention into this challenging field.⁶³

The pioneering work of Fuchita and coworkers put the basis for the use of gold based catalysts in the direct alkylation of aromatic hydrocarbons.⁶⁴ They found that, among many transition metal catalysts including Pd(II) and Cu(II), AuCl showed the highest activity at a 5% loading. Only recently, the versatility of gold has been exploited to develop direct alkylation strategies of heteroaromatic compounds. Waser and his group focused their attention to develop a practical methodology to accomplish alkynyl heterocycles. Firstly, their efforts were directed to indole and pyrrole nuclei and during 2009 they reported a Au(I)-mediated direct alkylation reaction.⁶⁵ In 2010, the group extended the methodology to thiophenes and benzothiophenes.⁶⁶

The reaction conditions allowed a wide group tolerance and afforded yields up to 93%. Moreover, no inert atmosphere or dry solvents were necessary and the reaction was conducted at room temperature. The alkylation reagent is an hypervalent iodine compound, 1-[(triisopropylsilyl)ethynyl]-1,2-benziodoxol-3(1*H*)-one (TIPS-EBX) and a slight excess was needed (Scheme 54).

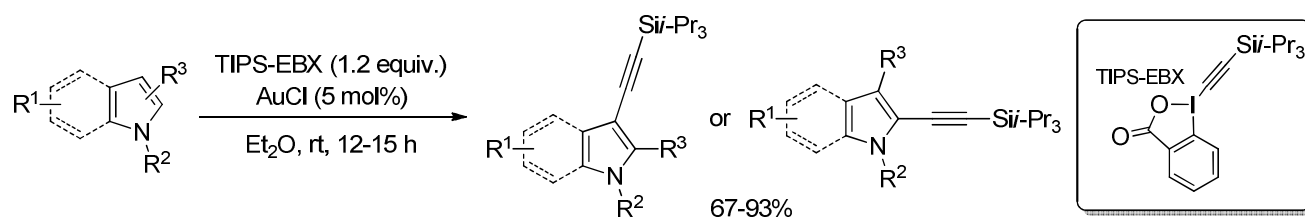

Scheme 54

Unsubstituted indoles afforded 3-alkynyl derivatives, whereas substrates with a substitution at C-3 afforded 2-alkynylindoles. Pyrroles proved to be more sensitive. Their reactivity was also affected by the steric properties of the *N*-substituent. As a matter of fact, 3-alkynylated products were obtained with *N*-substituted pyrroles, whereas 2-alkynylated products were obtained with nitrogen-protected substrates. Also di-, tri- and tetrasubstituted pyrroles were synthesized. It is worth to note that despite the well-established activity of gold species to activate carbon-carbon triple bonds, no hydroarylation on the alkyne system has been observed. 2-Iodobenzoic acid is the main side-product of the reaction and it is formed in stoichiometric amount. It can be recovered and converted to TIPS-EBX improving the sustainability of the procedure. Deprotection of the silyl-substituted alkynes by means of tetrabutylammonium fluoride (TBAF) allows the isolation of terminal acetylenes, available for further transformations.

Two plausible hypothesis were advanced for the mechanism. The catalyst can promote a carboauration of the TIPS-EBX triple bond to afford two possible vinylgold regioisomers **A** and **B**. Then, β -elimination from regioisomer **A** yields the 3-alkynylindole (Scheme 55, path a). Alternatively, an α -elimination/1,2-shift sequence can take place starting from regioisomer **B** yielding the product (Scheme 55, path b).

It is worth noting that no change in gold oxidation state occurs in this catalytic cycle. However, in a different mechanism, the Au(I) catalyst can be oxidized to the acetylide-Au(III) intermediate **C** (Scheme 56). Successive indole auration can generate the arylgold species **D** that, after reductive elimination, affords the 3-alkynylindole.

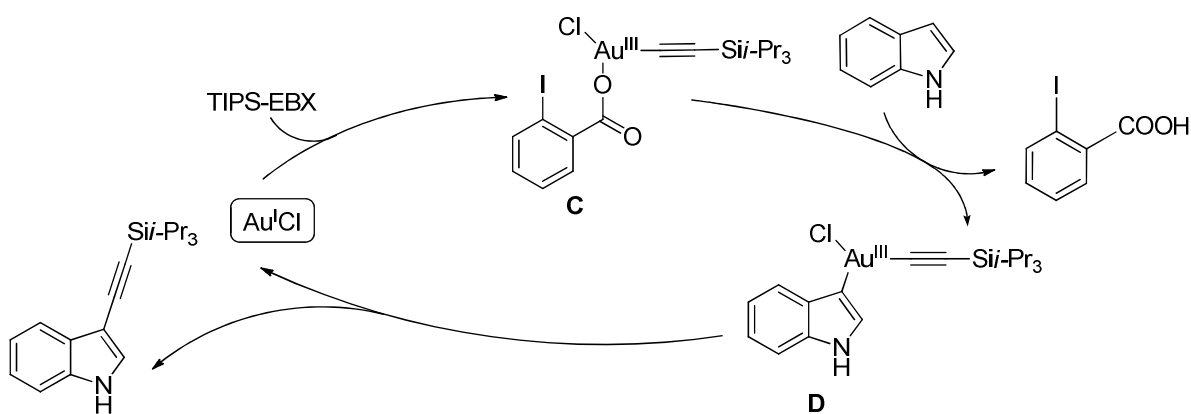
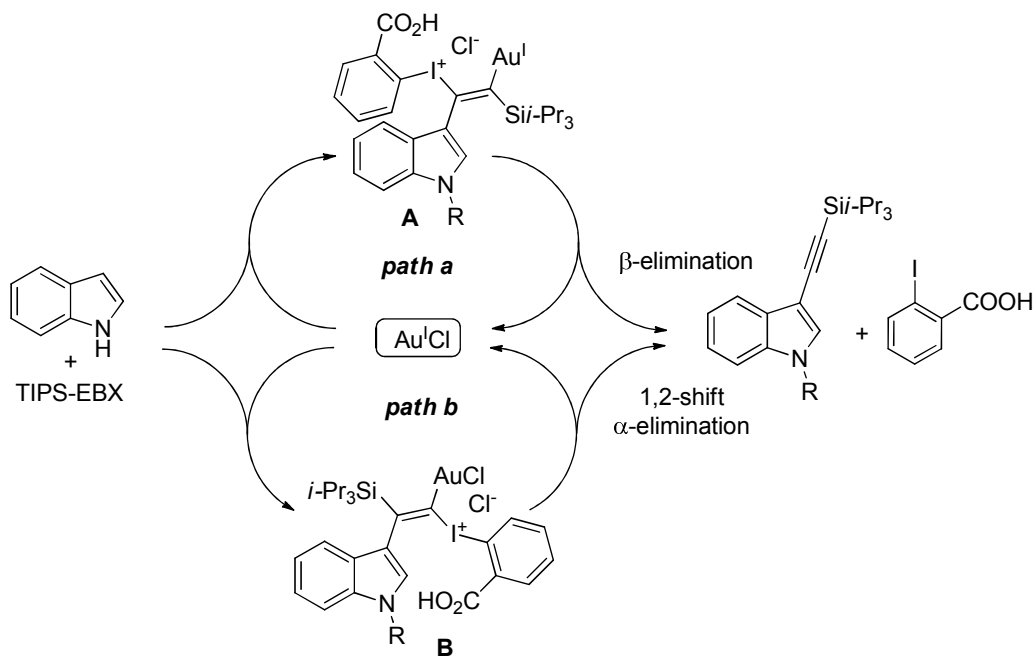

Moreover, the Waser group achieved in 2010 the direct alkylation of thiophenes and benzothiophenes exploiting the AuCl/TIPS-EBX system although the presence of stoichiometric Brønsted acid was needed (Scheme 57).⁶⁵

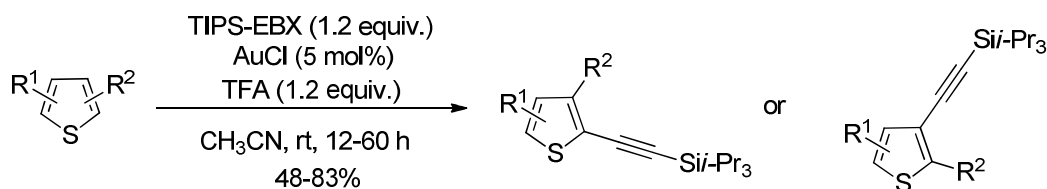

A simple proton catalysis was excluded because no alkylation product was observed in absence of AuCl. Anyway, the role of the Brønsted acid was not understood. 2-Substituted thiophenes were reactive and the reaction was tolerant toward several functional groups. Also benzothiophene afforded the ethynylated product but no regioselectivity was achieved. In general, less nucleophilic substrates needed harsher conditions.

Very recently, the same group exploited a similar reaction to obtain a sequential Au(III)/Au(I) catalyzed synthesis of 3-alkynylindoles starting from 2-alkynylanilines.⁶⁷ The general strategy is depicted in Scheme 58.

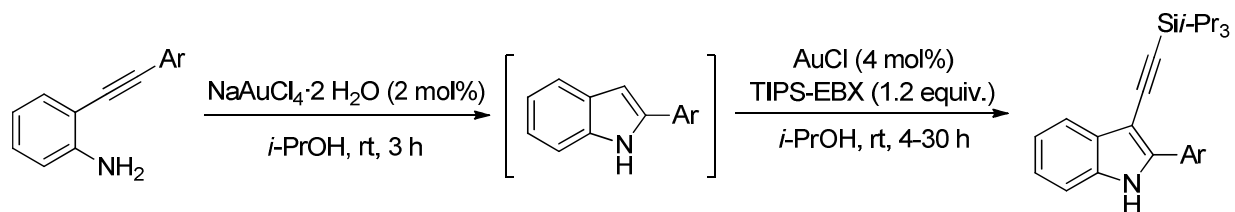

Scheme 58

The methodology was limited to 2-aryindoles bearing neutral, electron-donor and moderately electron-withdrawing groups and afforded products with good to excellent yields. However, despite AuCl has been reported to be an effective catalyst for the hydroamination of 2-alkynylanilines,⁶⁸ the authors noticed a lack of reproducibility, so that they looked at Au(III) catalyst. Unfortunately, NaAuCl₄·2H₂O was not an efficient catalyst for the alkylation step and a domino process could not be obtained.

Simultaneously with Waser and coworkers, Nevado and de Haro reported the ethynylation of electron-rich arenes and heteroarenes with electron-deficient alkynes by means of AuCl(PPh₃) as catalyst. Only two heterocyclic substrates have been reported. *N*-Benzylpyrrole delivered 2- and 3-ethynylated derivatives in 43% and 26% yield, respectively. *N*-Benzylindole afforded 3-ethynyl derivative in 60% yield (Scheme 59).⁶⁹

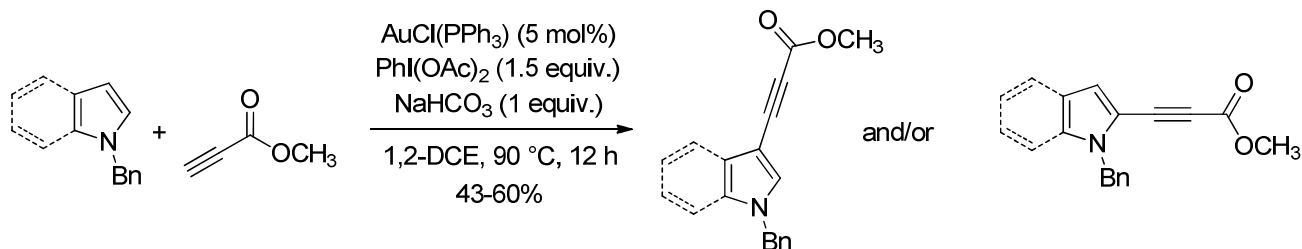

Scheme 59

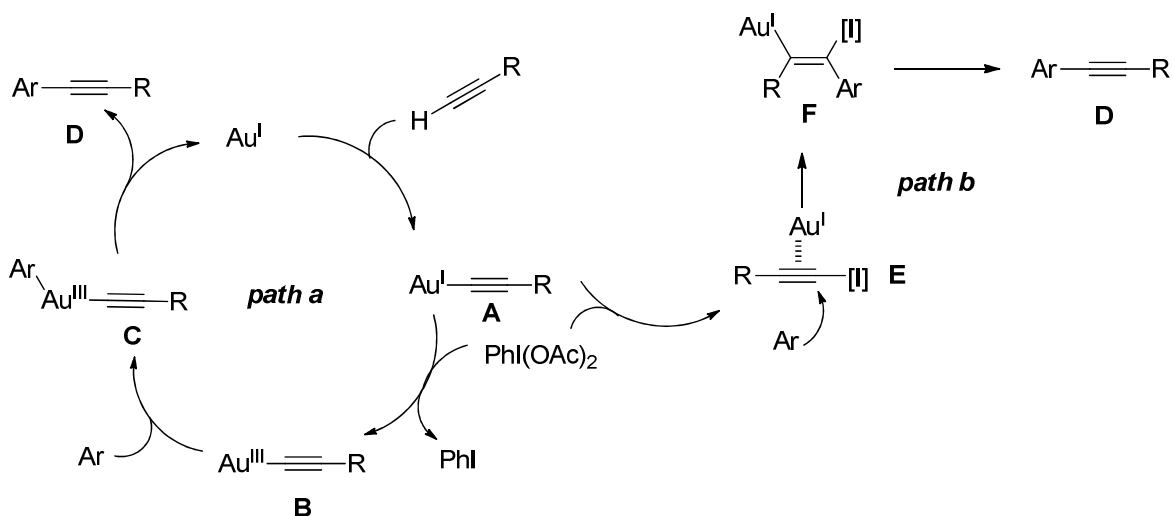

Scheme 60

The reaction conditions differed from those reported by Waser. A stoichiometric amount of NaHCO_3 was required and 2 equivalents of heteroarene with respect to methyl propiolate were necessary. The hypervalent iodine compound seemed to act as an oxidant, although Selectfluor[®] and *t*-BuOOH were not effective at all. The authors proposed two possible pathways with the common initial formation of the Au(I)-acetylide **A**. The organometallic species **A** could undergo an oxidation/arylation sequence affording **C**. After reductive elimination, the alkynylated product **D** would be generated (Scheme 60, path a). Alternatively, an alkynyl-iodonium intermediate **E** could be formed. The addition of the aromatic system to the triple bond followed by β -elimination could afford the desired product **D** (Scheme 60, path b).

6. Reactions involving rearrangement

In 2008, Sanz and coworkers reported in a communication⁷⁰ the first example of 1,2-indole migration of C-3 propargylated indoles under gold catalyzed conditions, involving the rupture and formation of C–C bonds. Thus, treatment of C-3 propargylated indole derivatives with 5 mol% of $[\text{AuNTf}_2(\text{PPh}_3)]$ yielded the 3-(2-indenyl)indoles **A**. Traces of 3-(3-indenyl)indoles **B** were observed in the crude samples for some reactions (Scheme 61a) and were due to intramolecular hydroarylation of the triple bond.⁷¹

In order to study the new 1,2-indole migration, the reaction was also performed using indole-containing alkynes that, differing from the previous ones, did not bear an aryl substituent at the propargylic position. When these compounds were treated with 5 mol% of $[\text{AuNTf}_2(\text{PPh}_3)]$ in methylene chloride at reflux, only 3-(2-indenyl)indoles **C** were obtained as unique product in high yield (Scheme 61b).

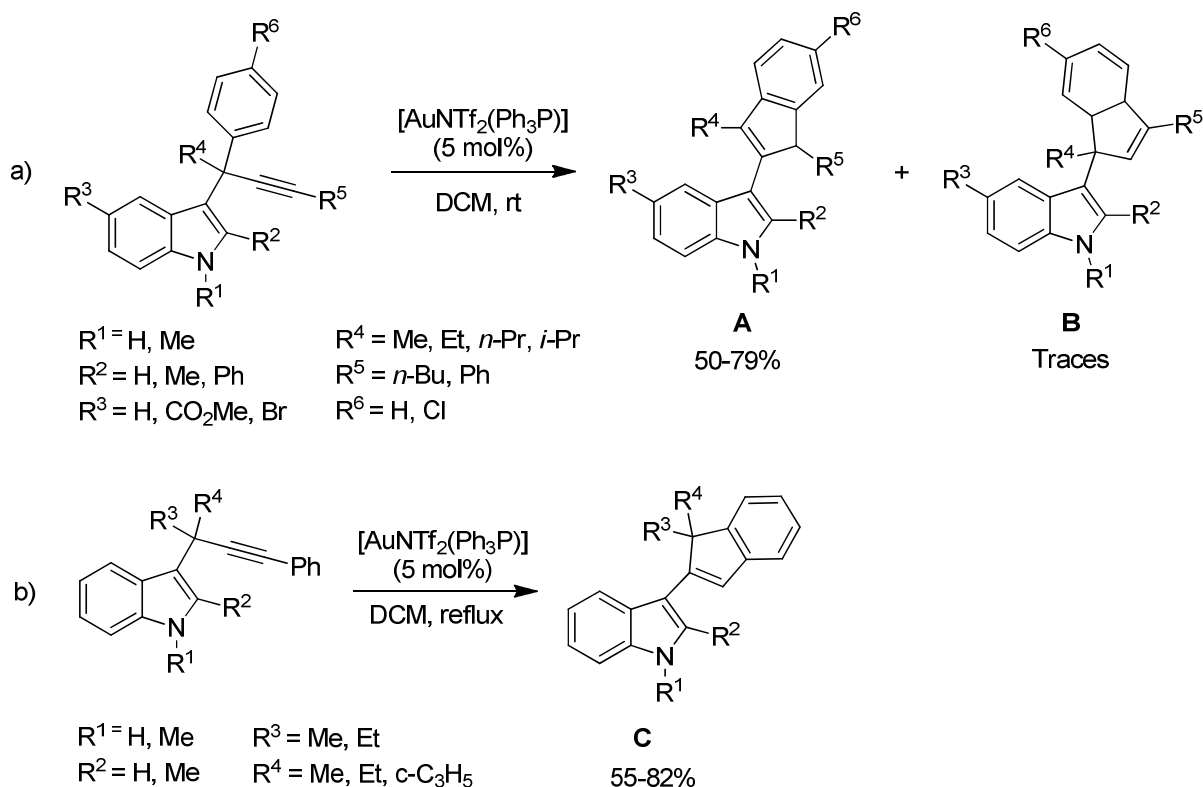

Scheme 61

It is noteworthy that in this last reaction the phenyl group that participate in the formation of the indene skeleton is that at the terminal position of the triple bond and not the propargylic one. A tentative mechanism

for the formation of 2-indenylindoles was proposed and should involve the formation of gold carbene complex **C** by a gold mediated 1,2-indole migration through intermediates **A** and **B**. Compound **C** may then evolve through a Nazarov-type cyclization to give **D** and, after rearomatization and protodemetalation, the final product (Scheme 62).

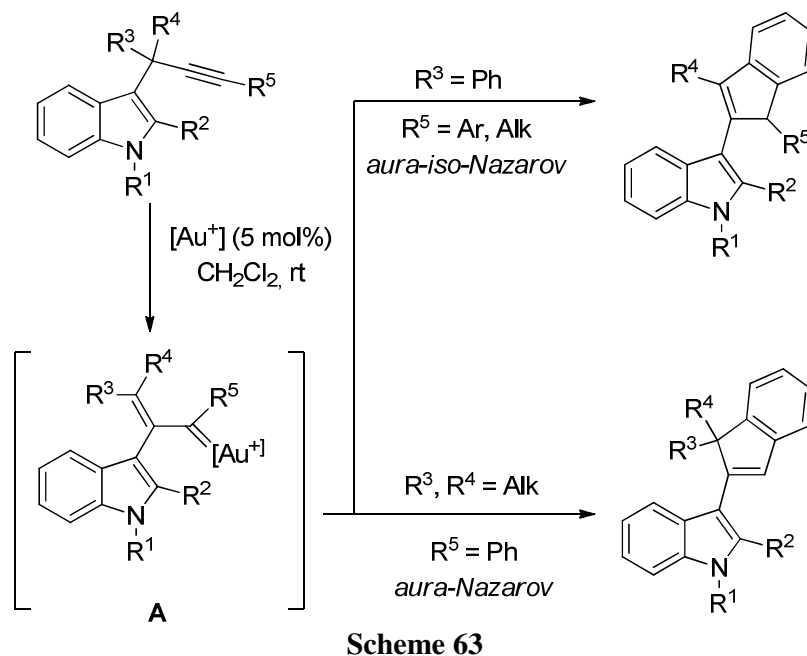
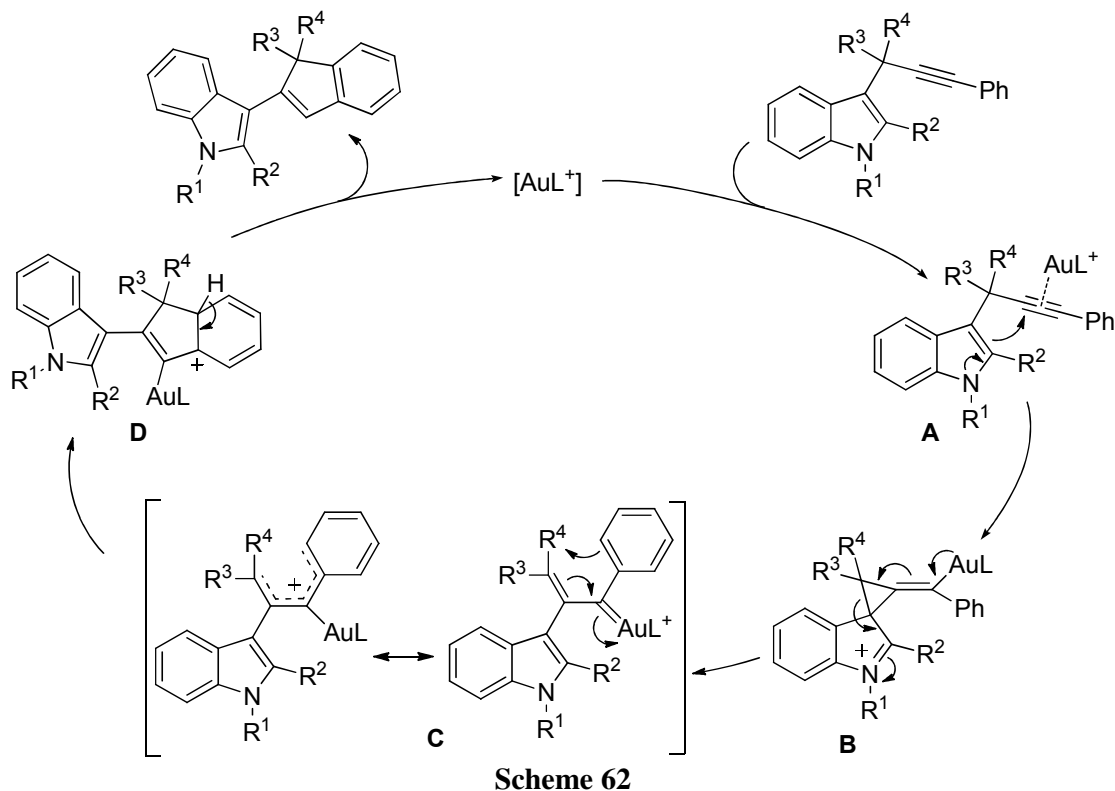

In a full paper published in 2010 by the same authors,^{72,73} the mechanism for the formation of the two 2-indenylindole derivatives was furthermore investigated taking into consideration that the reactions leading

to these compounds probably proceeded through the formation of a common intermediate obtained after the initial indole migration (Scheme 63). Thus, after the formation of common α,β -unsaturated gold carbenoid complex **A**, through rearrangement and 1,2-indole migration, two reaction pathways are possible depending on the substitution at the β -carbon of this compound. When a phenyl group is present on this position, an intramolecular attack of the phenyl group to the carbene carbon of **A** would lead to the product through an *aura-iso*-Nazarov mechanism. On the other hand, when two alkyl groups are present on propargylic position and R^5 is an aryl/heteroaryl group, the reaction may proceed according to mechanism proposed in Scheme 62 through Nazarov-type cyclization.

The synthesis of 3-(1,3-dien-2-yl)indoles by tandem 1,2-indole migration/1,2-C–H insertion from 3-propargylic indoles was investigated. In this case, the *aura-iso*-Nazarov or gold Nazarov cyclizations was not possible for the gold intermediate **A** (Scheme 64). To this scope, different indole derivatives were tested under the reaction conditions previously reported, yielding 3-dienylindoles as mixture of geometric isomers.

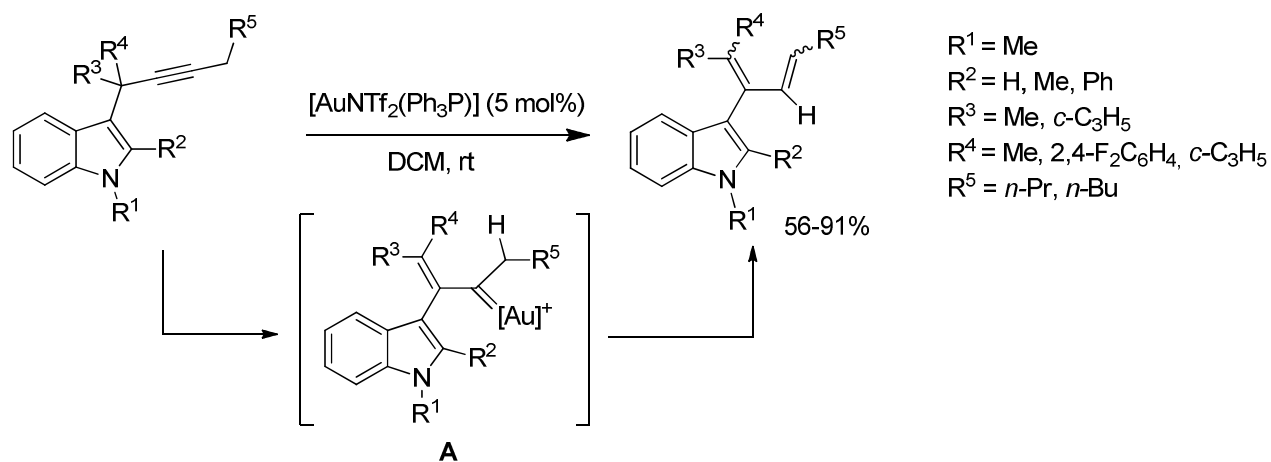

Scheme 64

The same catalytic system has been also applied in intermolecular reactions of indoles with ynols, where the first step is a Brønsted acid-catalyzed substitution reaction (Scheme 65).⁷⁴

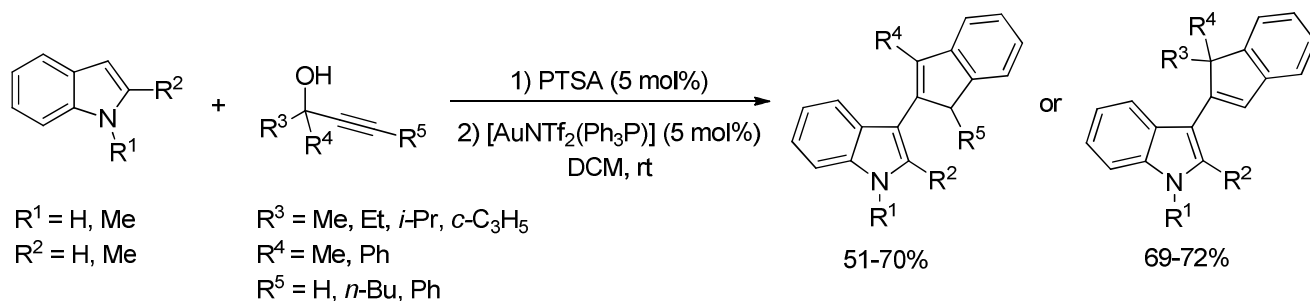

Scheme 65

The consecutive reactions of indoles and propargylic alcohols with PTSA (5 mol%) and $[\text{AuNTf}_2(\text{PPh}_3)]$ (5 mol%) in CH_2Cl_2 at room temperature, led to the formation of 3-indenylindoles in good yields. Notably, the one-pot procedure does not require any solvent change or removal of PTSA prior to the addition of gold catalyst. This method is also convenient for synthesis of fused-bicyclic compounds and dienyl derivatives (Scheme 66).

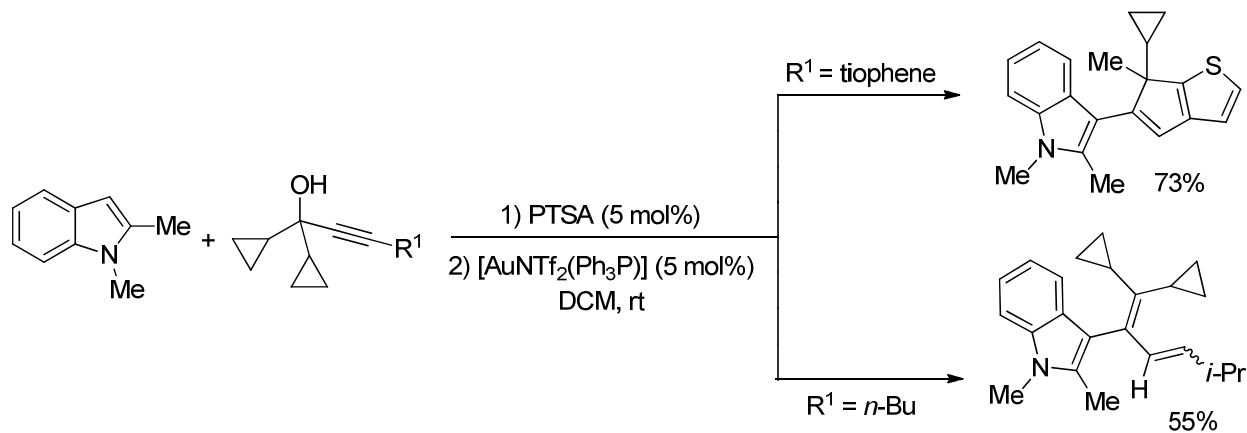

Scheme 66

In 2010, Li and Liu, reported the first example of 1,5-indole migration, which accomplished to C-3 allenylation and led to the formation of highly functionalized 3-allenylindoles in good yields.⁷⁵ They developed a domino process for the construction of indole-fused carbocycles starting from 3-(ω-alkynyl-1-yl)indoles by a Friedel-Crafts/hydroarylation sequence (Scheme 67).⁷⁶

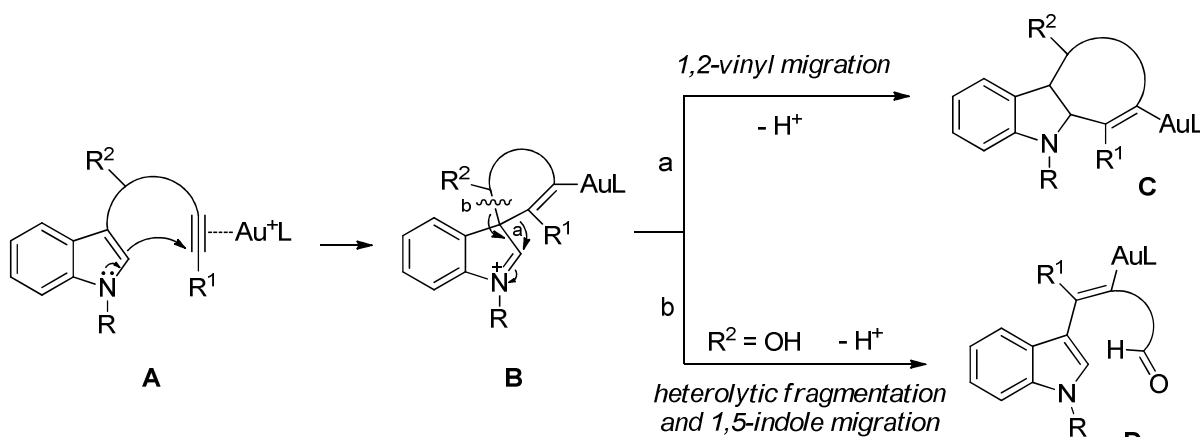

Scheme 67

These annulation reactions proceeded through formation of the alkyne-gold complex **A**, that was followed by formation of the C–C bond at C-3 leading to a spirocyclic iminium ion **B** and then 1,2-migration to generate fused indoles **C** (path a). On the other hand, when R² was an hydroxyl group, heterolysis⁷⁷ of the bond “b” occurred, favoured by formation of a C=O double bond, to generate the pyrrole-aldehyde **D** (path b).

Indoles bearing two hydroxyl groups were synthesized in two or three steps from the readily available indole-3-carbaldehydes and then transformed into products using 7.5 mol% of [(PPh₃)AuCl] and 5 mol% of AgSbF₆ in dichloroethane. Both electron-rich as well as electron-deficient aryl substituent on alkyne afforded good yields of 3-allenylindole, while when R¹ is an alkyl group the yield decreased. Regarding the indole moiety, the N atom could be protected with different groups and the functionalization of phenyl ring was also tolerated (Scheme 68).

The mechanism proposed for the gold catalyzed formation of allenyl indoles involves: 1) the activation of C–C triple bond of the alkynylindole by Ph₃PAu⁺, generated through chloride abstraction by silver salts;

2) *6-endo-dig* addition of indole C-3 onto the gold(I) alkyne complex **A**, resulting in the formation of spirocyclic intermediate **B**; 3) the heterolytic fragmentation of **B**, rather than normal 1,2-migration, takes place leading to 1,5-indole migration to afford the alkenyl gold species **C**; 4) formation of the allenyl aldehyde after elimination of H₂O and regeneration of the cationic Au(I) catalyst. The final step may also occur through a cationic intermediate formed by elimination of H₂O (Scheme 69).

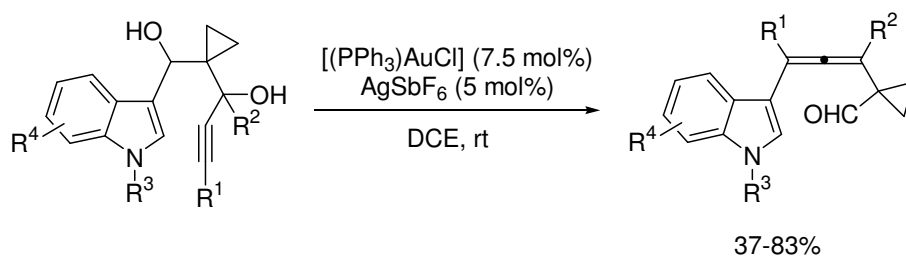

R¹ = Ph, *p*-MeOC₆H₄, *p*-BrC₆H₄, *p*-EtO₂C-C₆H₄,
 2-thienyl, *n*-Bu
 R² = Ph, *p*-MeOC₆H₄
 R³ = Me, allyl, CH₂Ph
 R⁴ = H, 5-Me, 5-Br, 6-Me, 2-Me

Scheme 68

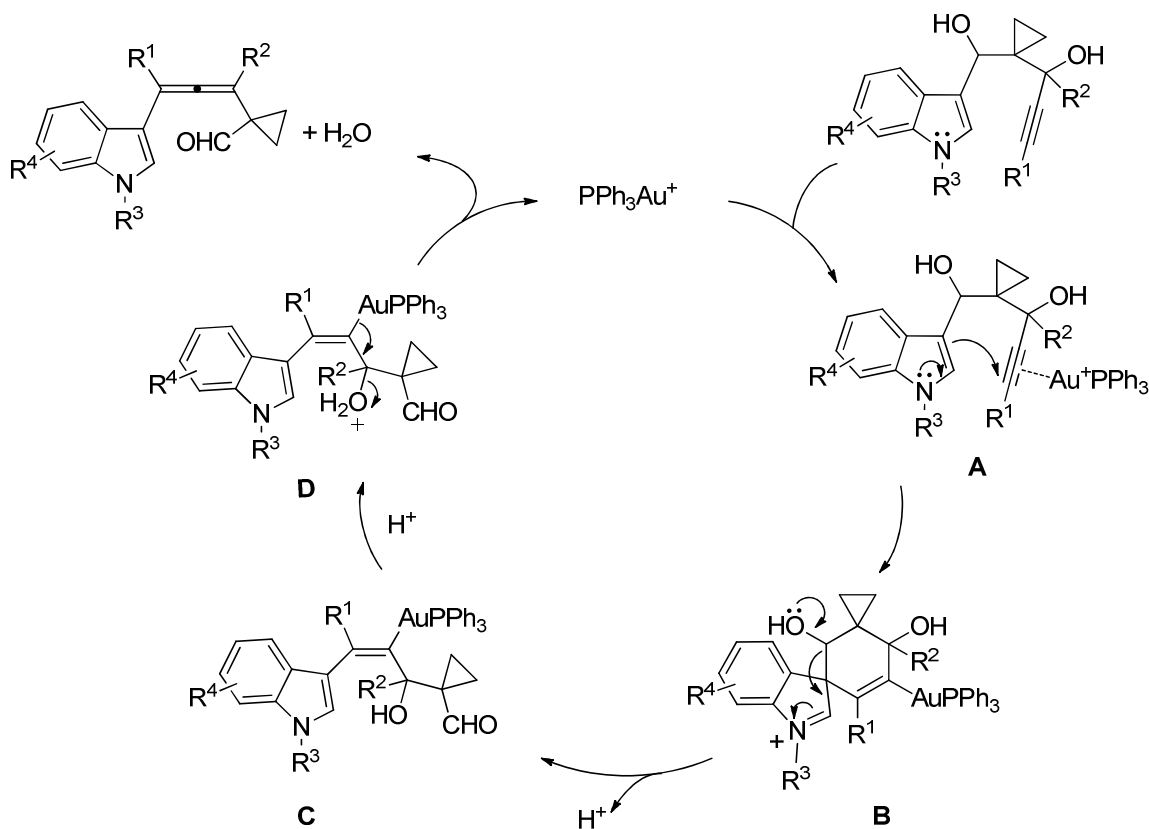

Scheme 69

The synthetic potential of the obtained allenylindoles has been shown in the efficient preparation of dihydrocyclopenta[*b*]indole (Scheme 70).

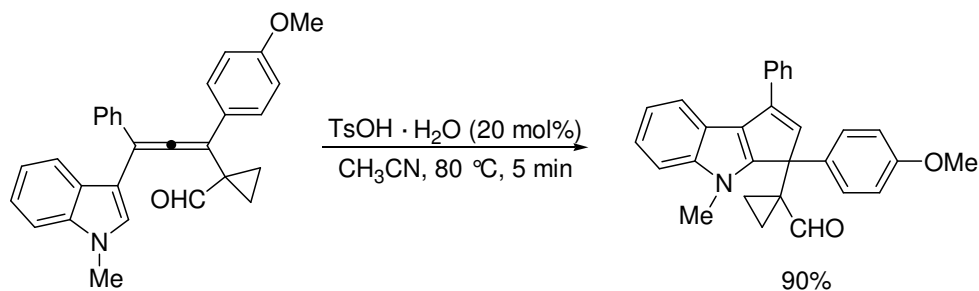

Scheme 70

7. Domino reactions

As defined by Tietze in 1996, a domino reaction is “a process involving two or more bond-forming transformations (usually C–C bonds) which take place under the same reaction conditions without adding additional reagents and catalysts, and in which the subsequent reactions result as a consequence of the functionality formed in the previous step”.⁷⁸ Moreover, reactions where a single catalyst promotes two or more mechanistically distinct processes are a particular case of *concurrent tandem catalysis*.⁷⁹ Gold salts and complexes demonstrated to be effective catalysts for these useful approaches and some valuable examples have been reviewed by Arcadi⁸⁰ and Echavarren.⁸¹ In the last years, domino processes involving the functionalization of an heterocycle as key step have been published. These synthetic approaches often involve sequences in which hydroarylations, cycloisomerizations, Friedel-Crafts-type reactions, rearrangements and cycloadditions occur in an ordinate sequence. In this section, a selection of domino reactions in which the gold catalyst is involved in all key steps is reported.

A smart example was reported by Zhang in 2005;⁸² the cationic Au(I) complex derived from AuCl(PPh₃)/AgSbF₆ was able to activate first the propargylic moiety and then the *in situ* generated allene function, leading to the quick formation of highly functionalized 2,3-indoline-fused cyclobutanes *via* a sequential 3,3-rearrangement/[2+2] cycloaddition reaction (Scheme 71).

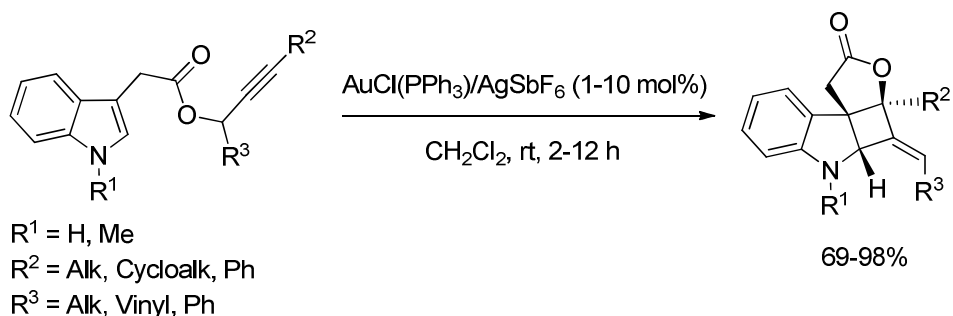

Scheme 71

Alkyl substitution at the indole nitrogen and the presence of a phenyl group at the propargylic position were well tolerated whereas a phenyl group on the alkyne caused diminished reactivity, so that a further amount of catalyst was necessary to drive the reaction to completion. More bulky substituents at either the propargylic position or the alkyne terminus slightly lowered the yield. Interestingly, the reaction failed with the unsubstituted propargyl indole-3-acetate ($R^1=R^2=R^3=\text{H}$) and did not tolerate the presence of two substituents at the propargylic position and the benzyloxymethyl group as R^2 or R^3 .

The proposed mechanism for the formation of cyclobutane ring involves the 3,3-rearrangement of the indole-3-acetoxy group promoted by the Au(I) activation of the triple bond of propargylic ester, which leads

to the formation of an allenyl ester (Scheme 72). Then, the allene moiety is further activated by the catalyst, resulting in the formation of both isomeric oxonium intermediates **A** and **B**, the latter less strained and thermodynamically favoured. Cyclobutane is finally formed by cyclization of the oxonium group to the 3-position of the indole ring, followed by intramolecular trapping of the iminium with the alkenylgold(I) (Scheme 72). The involvement of allenyl esters was proved by $^1\text{H-NMR}$ experiments. Moreover, simple Au(III) salt such as AuCl_3 was able to promote the 3,3-rearrangement of propargyl esters to allenyl esters, but failed to catalyze the cycloaddition step.

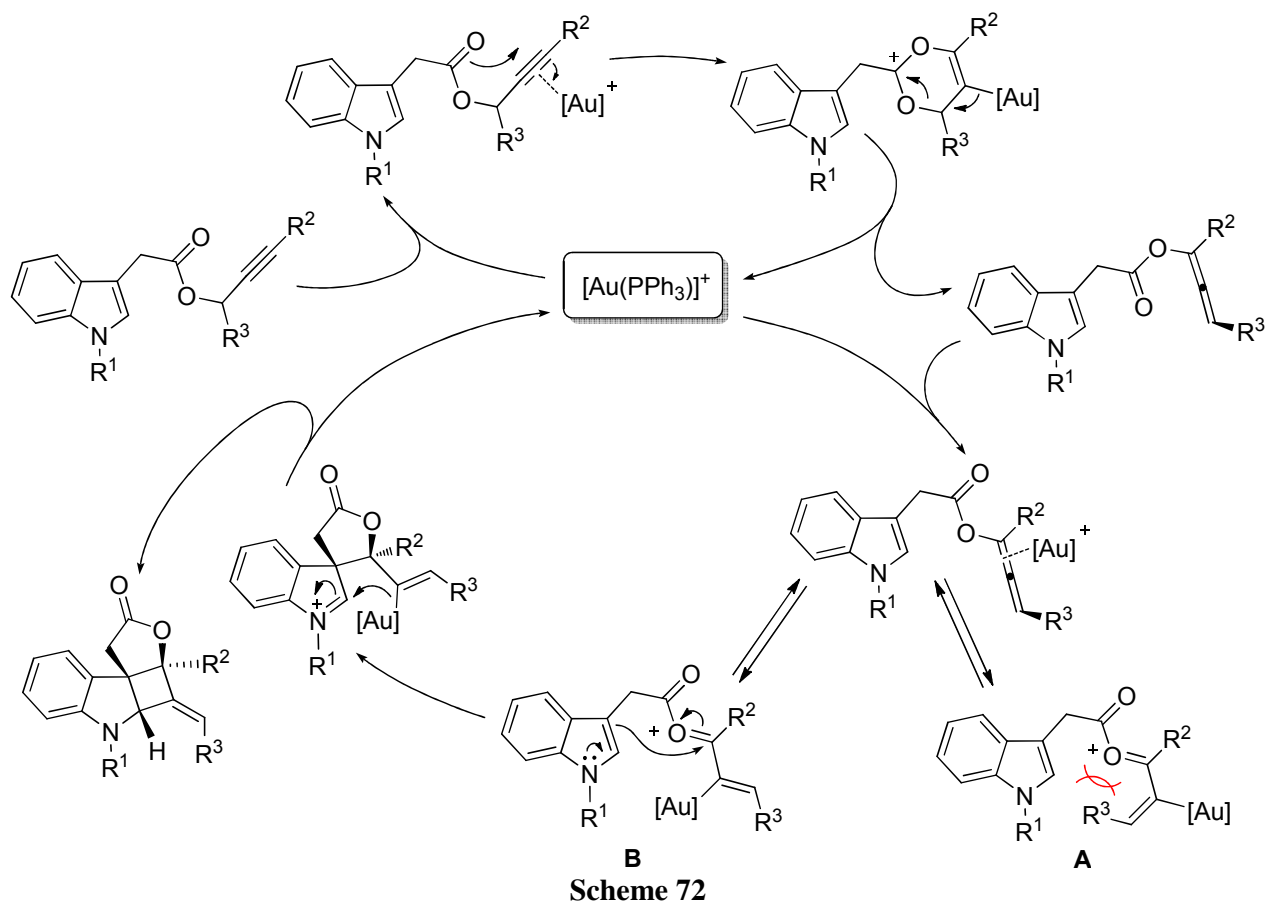

Starting from a quite similar substrate, the Echavarren group^{2g, 52a} reported that 3-substituted indoles react intramolecularly with tethered alkynes in the presence of gold catalysts to give six- to eight-membered annulated compounds. They found that alkynyl indoles cyclized readily with a cationic gold(I) complex to give azepino[4,5-*b*]indole derivatives, whereas the use of the more electrophilic AuCl_3 led to azocino[5,4-*b*]indole by an 8-*endo-dig* process involving electrophilic attack at the C-3 indole carbon, that was not observed in other hydroarylations of alkynes (Scheme 73). Several gold complexes and salts, including new Au(I) complexes bearing bulky phosphines or *N*-heterocyclic ligands, were tested in the intramolecular reaction of indoles with alkynes. In general, the best catalyst for the formation of seven-membered rings was cationic gold(I) complex **A**, which allowed cyclizations in the absence of Ag(I) salts. Tryptophan, tryptamine, tryptophol derivatives and indoles with alkynes tethered by 2–3 carbon chains led to the corresponding cyclized compounds. Performing the reactions for longer times, 2-allenylindoles were formed through an unexpected fragmentation reaction and were able to react further under Au(I) catalysis to form tetracyclic compounds in a one-pot process.

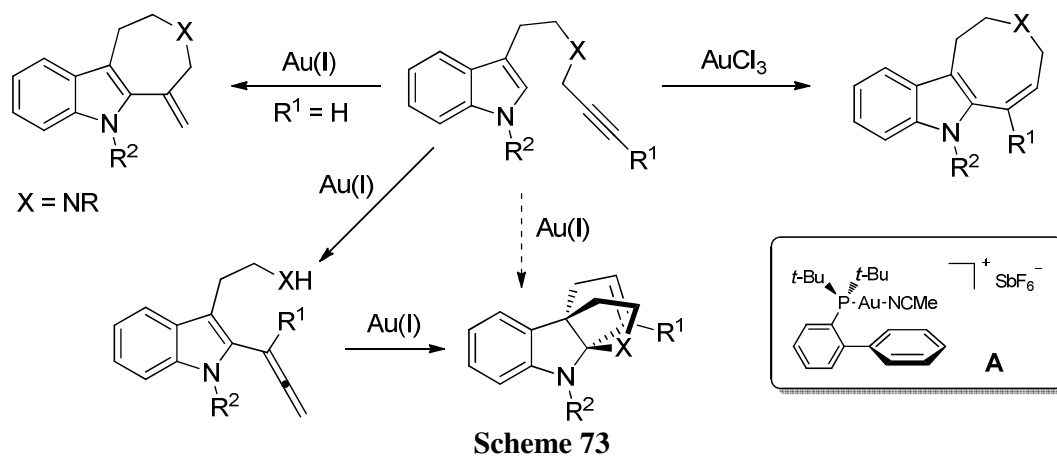

Eight-membered-ring compounds may arise from the initially formed spirocyclic iminium ion **A** to form the benzylic cation **B** by a carbon 1,2-shift. Then, loss of a proton would give the key intermediate **C** (Scheme 74). The proto-demetalation of **C** leads to the formation of the indolazocine ring whereas an alternative elimination, facilitated by the presence of the electron-withdrawing sulfonyl group on the nitrogen atom, would yield the allene *via* cationic intermediate **D**.

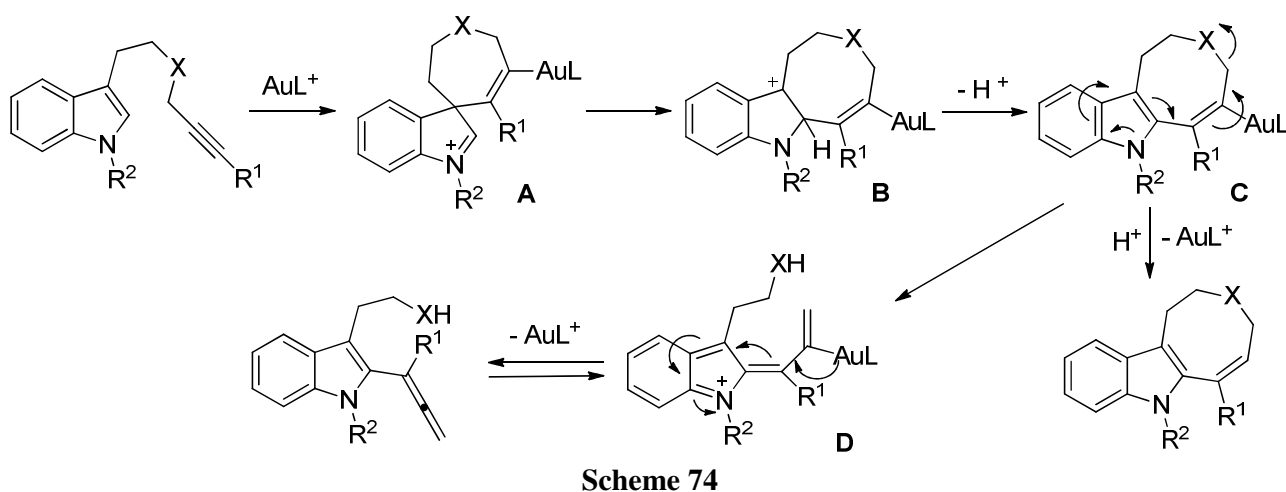

Starting from (*Z*)-enynols and indoles, Liu and coworkers reported a domino process for the synthesis of indole-fused carbocycles, that involves consecutive Friedel-Crafts and hydroarylation reactions, both mediated by the same gold catalyst.⁷⁶ This process enabled the formation of two C–C bonds at the C-2 and C-3 positions of indoles in a single operation (Scheme 75).

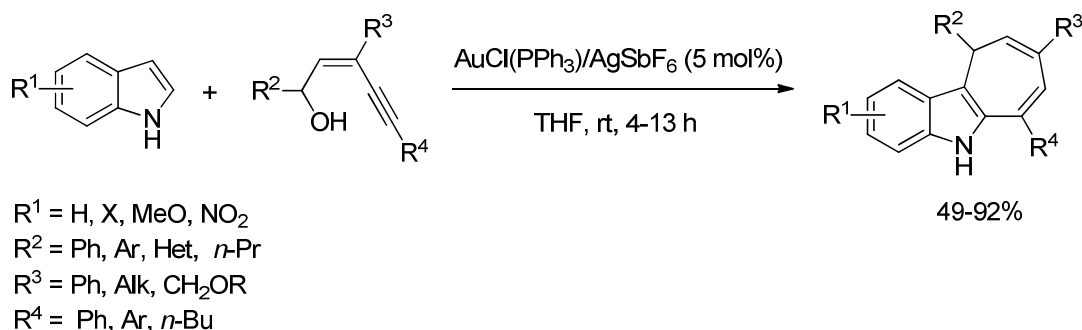

Best results were obtained with cationic Au(I) complex derived from AuCl(PPh₃)/AgSbF₆ in THF, and, similarly, with the preformed cationic complex [Ph₃P-Au]NTf₂. Conversely, gold(III) and silver(I) salts proved to be inactive. Interestingly, only the seven-membered ring derivative was formed by a 7-*endo-dig* pathway, while the regioisomer derived from a 6-*exo-dig* reaction was observed only when a terminal alkyne was tested. Several substituents were allowed on both (*Z*)-enynol and indole and the approach was also extended to pyrrole. The reactions run smoothly with benzylic enynols, but when R² was an alkyl group, a preliminary treatment with 1 equiv. of BF₃·Et₂O at 50 °C for 6 hours was necessary to promote the Friedel-Crafts arylation step.

The proposed reaction mechanism is described in Scheme 76. The reaction is initiated by cationic gold assisted C–O bond cleavage of enynol, resulting in the formation of the allylic cation intermediate **A**. This undergoes the Friedel-Crafts reaction with indole on C-3 to afford the indolyl enyne **B** (isolated by stopping the reaction after 10 minutes). The complex **C**, which is formed by coordination of gold to the triple bond, undergoes nucleophilic attack by indole to give the spirocyclic iminium ion **D**, from which the carbocation **E** is obtained by a 1,2-migration process.^{5b,52a,83} Elimination of a proton followed by protodemetalation of the resulting organogold intermediate affords the product with regeneration of the catalyst.

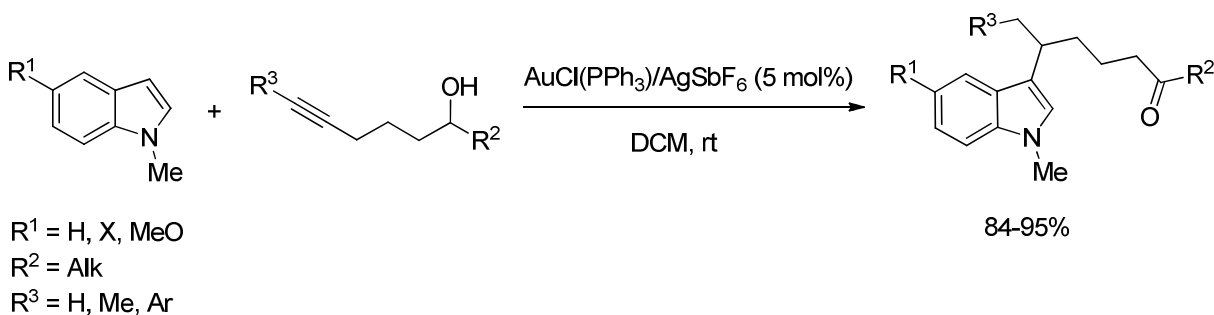
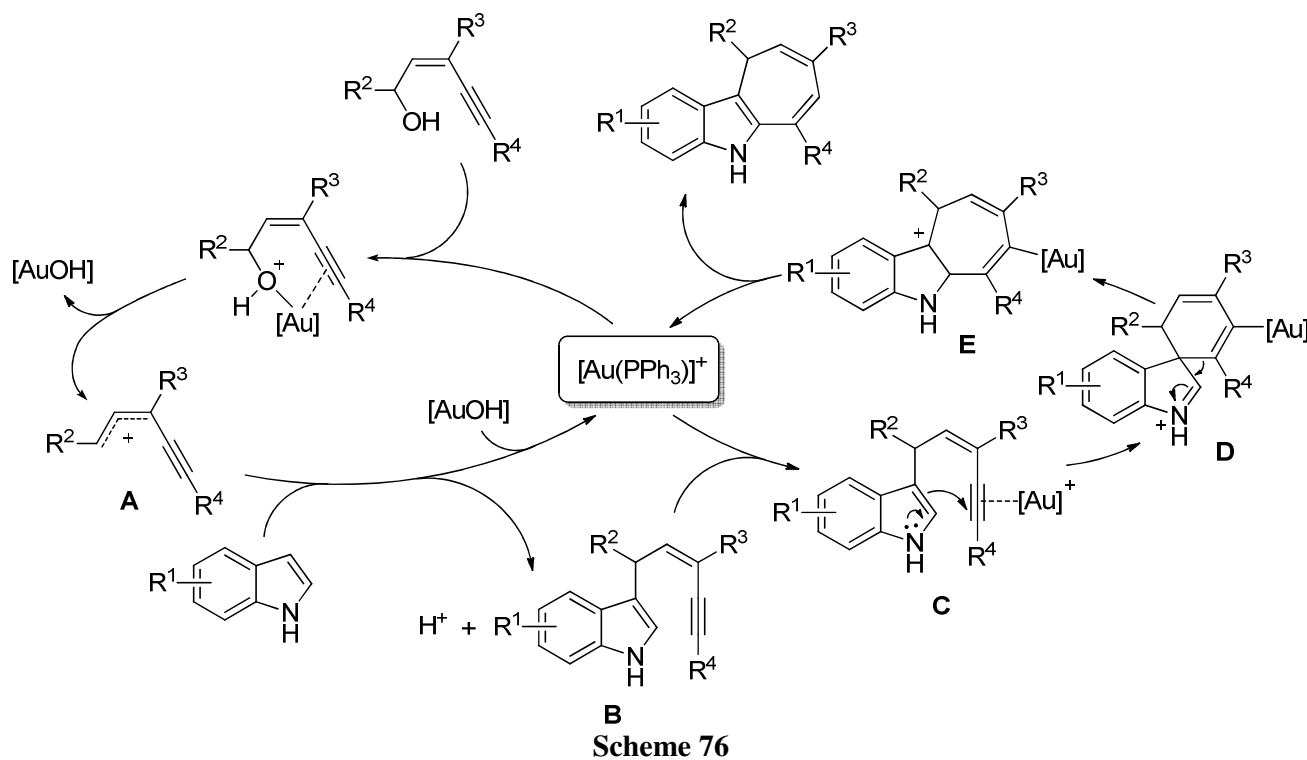

Scheme 77

N-Methylindole was the model substrate for a study performed by the group of Barluenga on a new gold(I) catalyzed cascade reaction of secondary 5-hexyn-1-ol derivatives that affords 5-heteroaryl-substituted ketones in an efficient and simple way.⁸⁴ Also in this reaction, the catalyst of choice was the cationic Au(I) complex derived from AuCl(PPh₃)/AgSbF₆ (Scheme 77).

The scope was investigated and the approach demonstrated to be effective also for *N*-protected pyrrole and 2,5-dimethylfuran, with only a slight reduction of yields (68–75%). The mechanism proposed, and supported by labelling studies with deuterated starting material, is shown in Scheme 78. It involves three self-determining gold catalyzed cycles: a classical intramolecular hydroalkoxylation reaction followed by an intermolecular hydroarylation of an *exo*-cyclic enol ether and finally an unusual intramolecular Oppenauer-type oxidation process involving a formal 1,5-hydride migration.

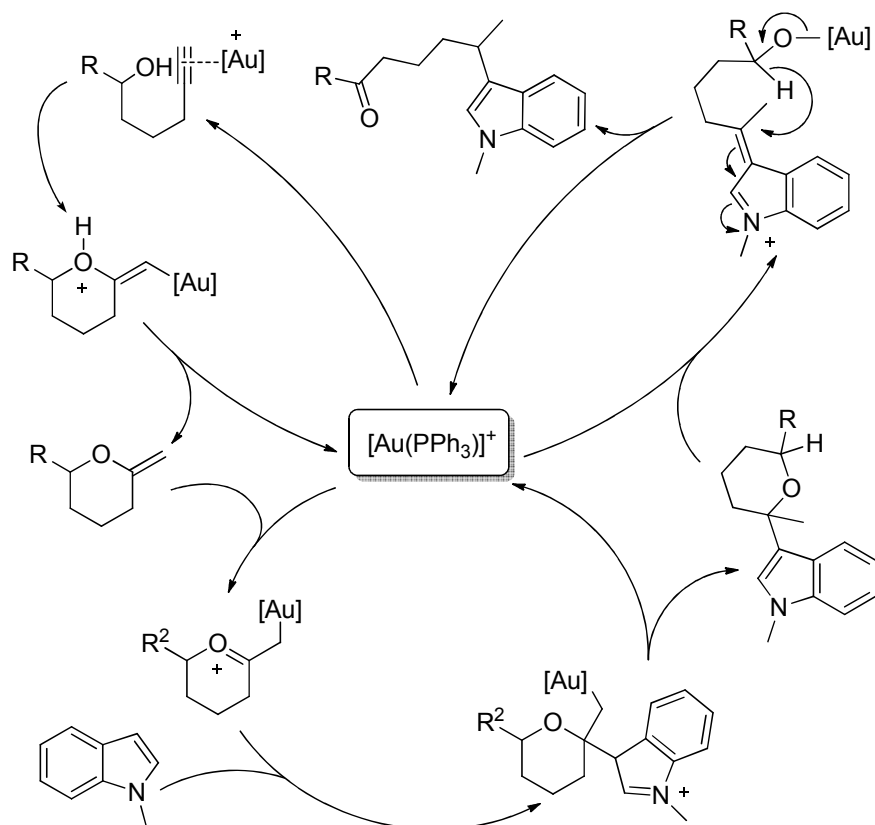

Scheme 78

Michelet, Genêt and coworkers described a chemo- and diastereoselective gold catalyzed tandem carbocyclization reaction under mild conditions through cycloisomerization/Friedel-Crafts sequence, starting from 1,6-enyne and suitable aromatic nucleophiles⁸⁵ (Scheme 79), including indoles, pyrrole and 2,5-dimethylfuran, whereas the reaction with thiophene failed.

The initial screening of the catalytic system showed that both Au(I) and Au(III) salts, in the presence of a phosphine ligand and AgSbF₆, gave good results at room temperature in diethyl ether. The choice fell on AuCl(PPh₃)/AgSbF₆ which gave more reproducible results. Electron-withdrawing groups on enyne were not tolerated and the alkene substitution pattern was critical for the success of the reaction. The authors reported also an enantioselective version of this approach.⁸⁶ Best results were obtained in the presence of the chiral complex 4-MeO-3,5-(*t*-Bu)₂-MeOBIPHEP(AuCl)₂ (3 mol%) and AgOTf (6 mol%) in diethyl ether. By this

way, the products were obtained after 15–20 hours at room temperature with a 37–99% yield and 80–95% enantiomeric excesses. It is worth to note that the Ag/Au ratio was also an important issue, in fact employing equimolar amounts of silver salt and di-gold complex a lower *e.e.* was obtained. Moreover, no conversion was observed using Brønsted acid or silver salts as catalysts.

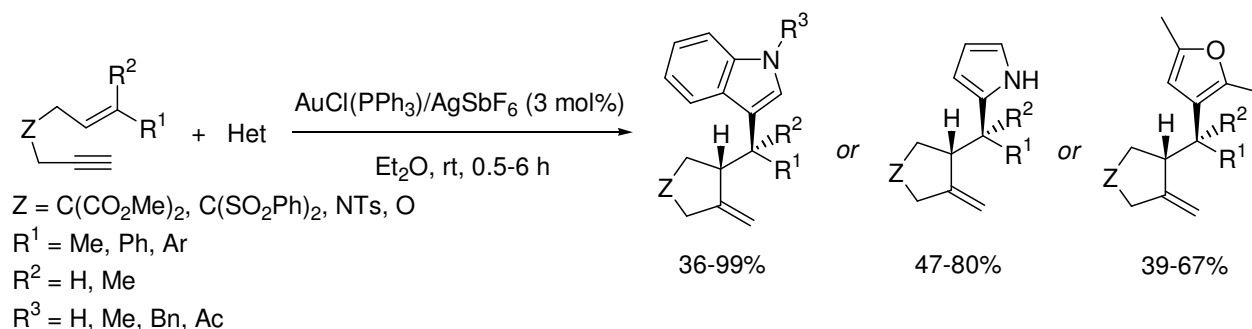

Scheme 79

The proposed reaction mechanism involves complexation of the cationic gold catalyst to the alkyne function leading to intermediate **A**. The cyclization step may occur directly, through a concerted Friedel-Crafts-type addition/carbocyclization sequence, leading to the vinyl gold intermediate **C**, or may proceed by stereoselective attack of the nucleophile on a transient carbene species **B**, as proposed in several metal-catalyzed cycloisomerization reactions.⁸⁷ The stereoselectivity of the process was supported by labelling experiments. On the basis of enantio- and diastereoselectivities observed in the reactions with and without chiral ligands and with different nucleophiles, the concerted “Michelet path” was considered more plausible.

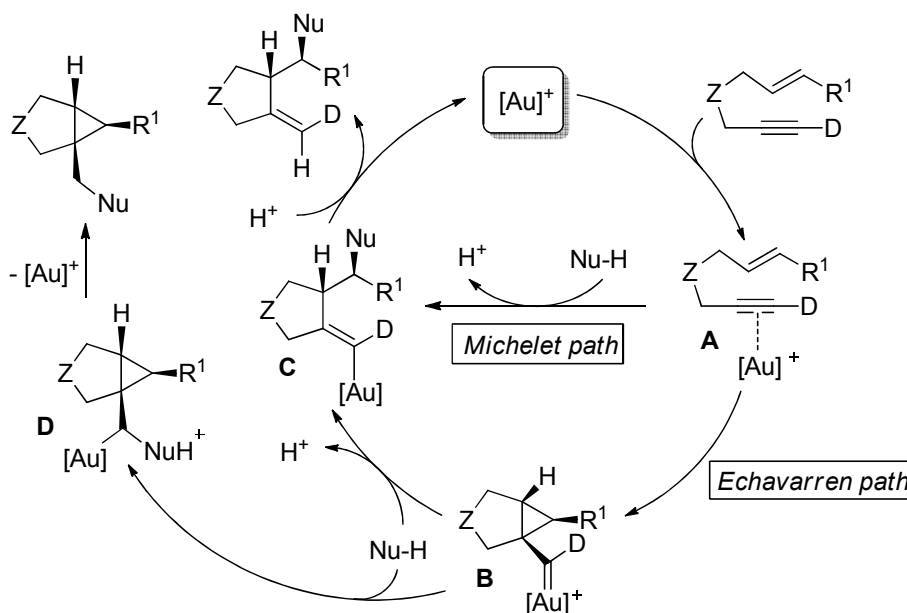

Michelet precatalysts:

$AuCl(PPh_3) \Rightarrow$ *diastereoselective*; $(R)-4-MeO-3,5-(tBu)_2MeOBIPHEP(AuCl)_2 \Rightarrow$ *enantioselective*

Echavarren precatalyst:

Scheme 80

It involves gold assisted cyclization of intermediate **A** and concomitant attack of the nucleophilic heterocycle to the electrophilic alkene carbon. The final step was the protodemetalation of the aurate intermediate (Scheme 80).

In a quite similar work, Echavarren and coworkers studied the gold(I) catalyzed addition of electron-rich arenes and heteroarenes, *e.g.* indole, to 1,6-enynes.⁸⁸ The reaction was efficiently catalyzed by (2,4-di-*t*-BuPhO)₃P–AuCl and AgSbF₆ in DCM under mild conditions. Differently from the Michelet protocol, in some cases fused cyclopropane derivatives were formed as peculiar side product (Scheme 81).

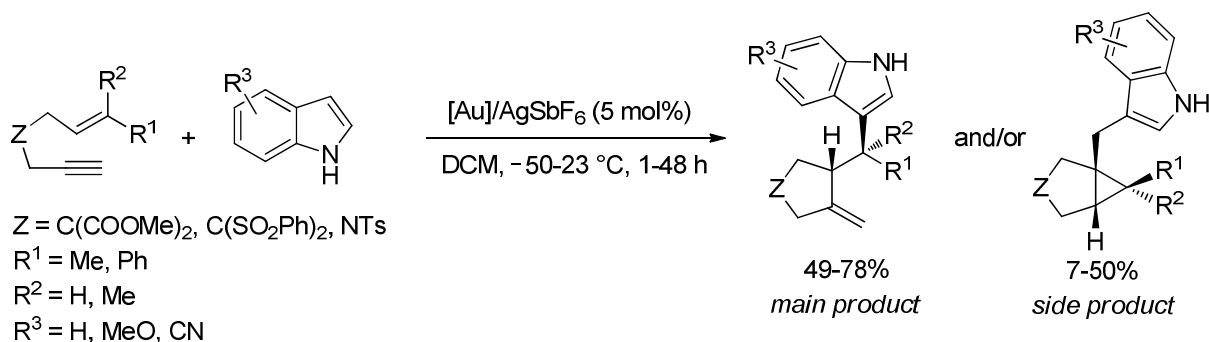

Scheme 81

For the authors, the formation of the side product presumably arises by cycloisomerization of the alkyne-gold complex **A** to give the gold carbene complex **B** bearing a fused cyclopropyl substituent. This intermediate can undergo nucleophilic attack at the cyclopropyl carbon to give the normal product *via* intermediate **C**, whereas attack to the carbene carbon leads to the bicyclic product *via* intermediate **D** (Scheme 80).

In 2009, Liu's group reported an efficient domino approach for the stereoselective synthesis of arylated (*Z*)-enones through gold(I) catalyzed reactions of enynols with furans (Scheme 82).⁸⁹ The process involves a Friedel-Crafts reaction of furans with enynols followed by a furan/alkyne cyclization in a one-pot procedure. PPh₃AuNTf₂ (5 mol%) was found to be the catalyst of choice and a number of (*Z*)-enones were prepared in good yield under mild conditions (Scheme 82). Interestingly, once again the use of simple AuCl₃ or AgOTf only afforded the product of Friedel-Craft reaction of furan in position 2.

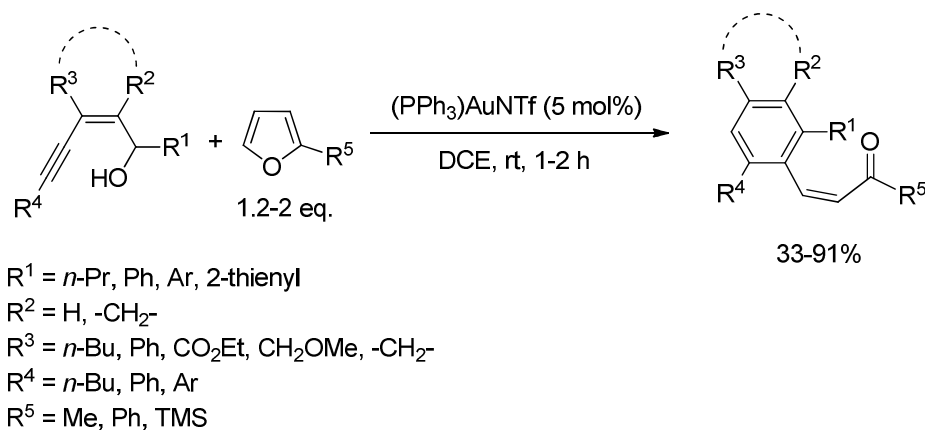

Scheme 82

In this reaction, the benzene carbons are provided by the five carbons of the enynol and the C-5 carbon of furan, while the three carbons of the lateral enone comes from the other furan carbons. Remarkably, only

the (*Z*)-isomer of enone was isolated. The reaction mechanism is shown in Scheme 83. The reaction is initiated by Au⁺-catalyzed Friedel-Crafts reaction of enynol with furan to afford the enyne **A** (*cfr.* Scheme 76). Then, intramolecular attack of furan to the gold alkyne complex **A** occurs by a 7-*endo*-cyclization mechanism and results into the formation of the intermediate **B**. Next, a cyclopropyl gold carbenoid **C** is formed.⁹⁰ Rearrangement of **C** by cleavage of a C–C and C–O bond affords the carbene complex **D** with the (*Z*)-enone moiety. Aromatization by loss of a proton and protodeauration finally gives the β-aryl (*Z*)-enone.

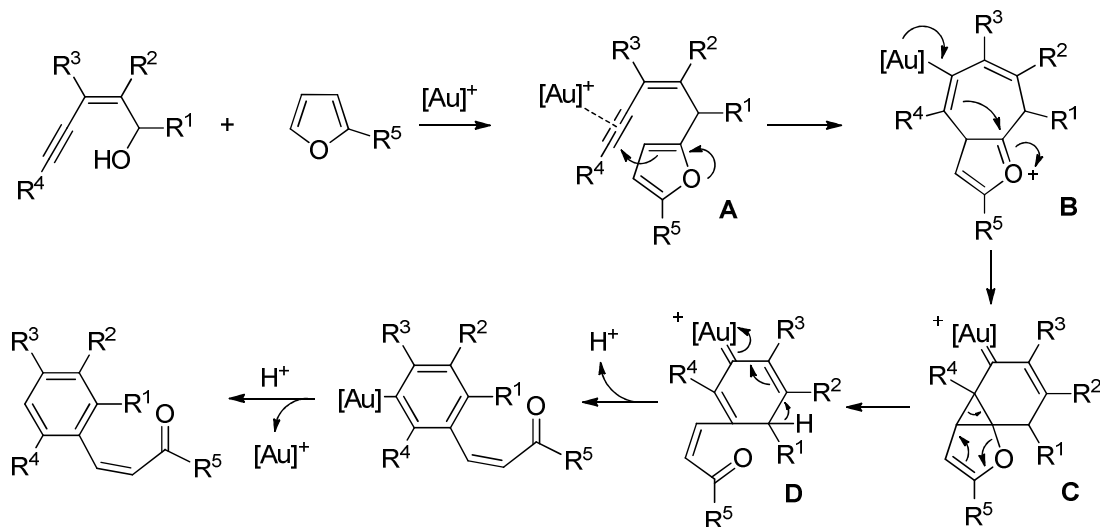

Scheme 83

A reverse Au(III)-catalyzed tandem approach involving first a cyclization followed by a Friedel-Crafts type reaction has been reported by Liang and coworkers.⁹¹ Thus, starting from substituted 1-(oxiran-2-yl) prop-2-ynyl esters in the presence of a suitable nucleophile (including furans, pyrroles and indoles), new furan derivatives were obtained under very mild conditions. The use of 10 equiv. of furan and HAuCl₄·4H₂O (2 mol%) in wet 1,4-dioxane at room temperature were found to be the most efficient reaction conditions (Scheme 84), but also AuCl gave the same yields on the model reaction. The authors excluded the possibility of a proton catalysis on the basis of the results obtained in a previous work.⁹²

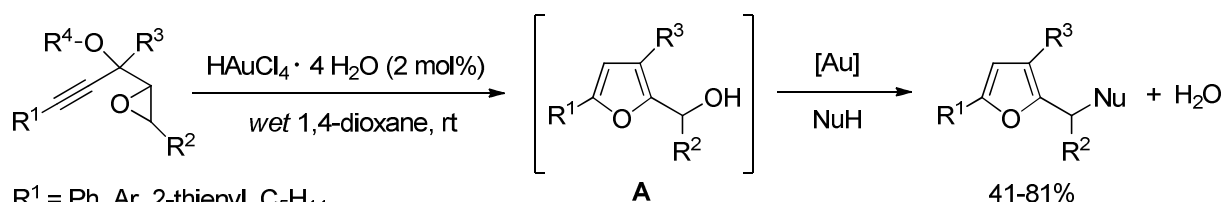

R¹ = Ph, Ar, 2-thienyl, C₅H₁₁

R² = H, Me, Ph, Ar

R³ = H, Me

R⁴ = Ac, CO₂Me, CO₂*t*Bu

Nu = furan, pyrroles (reaction time: 10-60 min), indole (reaction time: 10 h at 80 °C)

Scheme 84

When R¹ or R² are hydrogen or alkyl groups, the yields were the lowest (41–50%) and extra amount of catalyst and nucleophile were mandatory. Curiously, the reaction with indole as nucleophile gave modest yield (51%) and needed long reaction time, higher temperature and 5 mol% of catalyst. According to literature and previous findings,⁹² the proposed mechanism involves the formation of the intermediate **A**

(Scheme 84) (isolable when water is the only nucleophiles in reaction mixture), by domino nucleophilic attack/anti-endo-dig cyclization of the substrate where the triple bond is activated by gold, followed by a gold promoted intermolecular Friedel-Craft type reaction. It is worth to note that, during this reaction, water as a transient nucleophile was the key step.

An original approach exploits *in situ* formation of iminium ions from carbonyl functions as electrophiles in intramolecular gold catalyzed cyclization reactions with a tethered nucleophile.⁹³ These reactions can be viewed as cascade process in which the gold(I) catalyzed cyclization of alkynoic acids⁹⁴ is the first step of a sequence leading to bicyclic iminium ions, which undergoes intramolecular nucleophilic attack resulting in the formation of multi-ring heterocycles (Scheme 85).

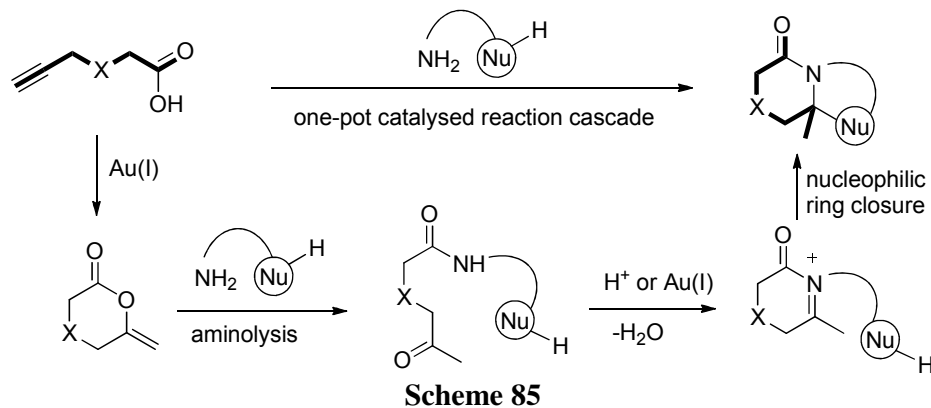

In the first study on this topic, published by Dixon and coworkers, a model reaction was used to determine the feasibility of the cascade (Scheme 86). Thus, treatment of a toluene solution of 1 mol% AuPPh₃Cl/AgOTf with 2-benzylhex-5-ynoic acid followed by 2-(1*H*-pyrrol-1-yl)ethanamine lead to the corresponding intermediate ketoamide in 71% yield (Scheme 86, path a). Although the desired heterocyclic product was not formed, these studies confirmed that the cyclization and concomitant attack of amine were feasible. Thus, the reaction sequence was repeated using toluene at reflux. The desired tricyclic product could be obtained in 68% yield after heating the reaction mixture at the reflux temperature for 2 days (Scheme 86, path b). The scope of reaction cascade was finally surveyed by probing changes to both the alkynoic acid and the substituted ethyl amine (Scheme 86).

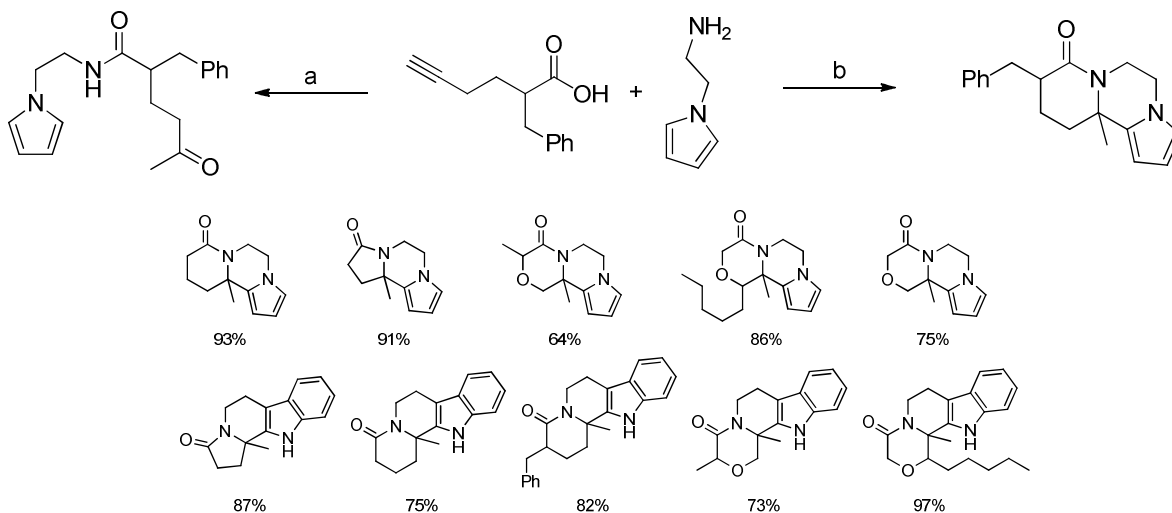

The role of gold(I) catalyst in cyclization of alkynoic acids is well documented,⁹⁴ whereas the nature of the effective catalyst in the *N*-acyliminium ion cyclization cascade was demonstrated by performing a series of experiment on the isolated ketoamide intermediate. The obtained results suggest the gold species is providing Brønsted acidity not Lewis acidity to facilitate *N*-acyl iminium ion formation and that Lewis acid-assisted Brønsted acid catalysis, resulting from the 1% gold in the presence of either water (formed in the reaction) or another proton donor, provides the activation for the second stage of the cyclization cascade. Starting from these results, the same authors reported the enantioselective variant of the same cascade reaction achieved in the presence of gold(I) catalyst for the cyclization of the alkynoic acid and of chiral Brønsted acids [(*R*)-BINOL phosphoric acid derivatives] for the subsequent *N*-acyliminium ion formation/cyclization step.⁹⁵

In a related approach, a new entry to polycyclic fused diazepinedione heterocycles has been reported in 2011 by the group of Liu.⁹⁶ The synthesis of benzo[*e*]indolo[1,2-*a*]-pyrrolo/pyrido[2,1-*c*][1,4]diazepine-3,9-diones was accomplished by a silver-/gold-mediated one-pot domino process starting from *N*-(*o*-amino-benzoyl)-indole and 4-/5-pentynoic acids (Scheme 87).

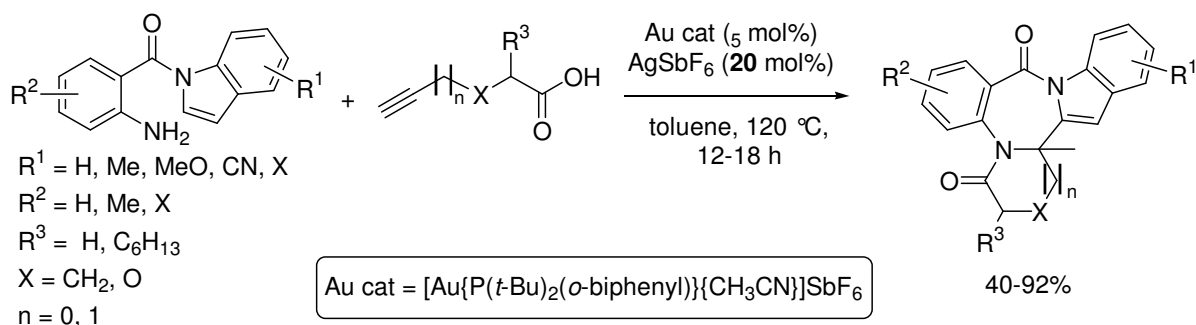

Scheme 87

The screening of reaction conditions on the model reaction showed that best result (92% yield) was obtained in toluene at 120 °C in the presence of an unusual mixture of a preformed cationic gold complex (5 mol%) and AgSbF₆ (20 mol%). However, the use of the silver salt alone (20 mol%) led to slightly worse result (84% yield), while the sole cationic gold complex (5 mol%) gave a poor result (23% yield).

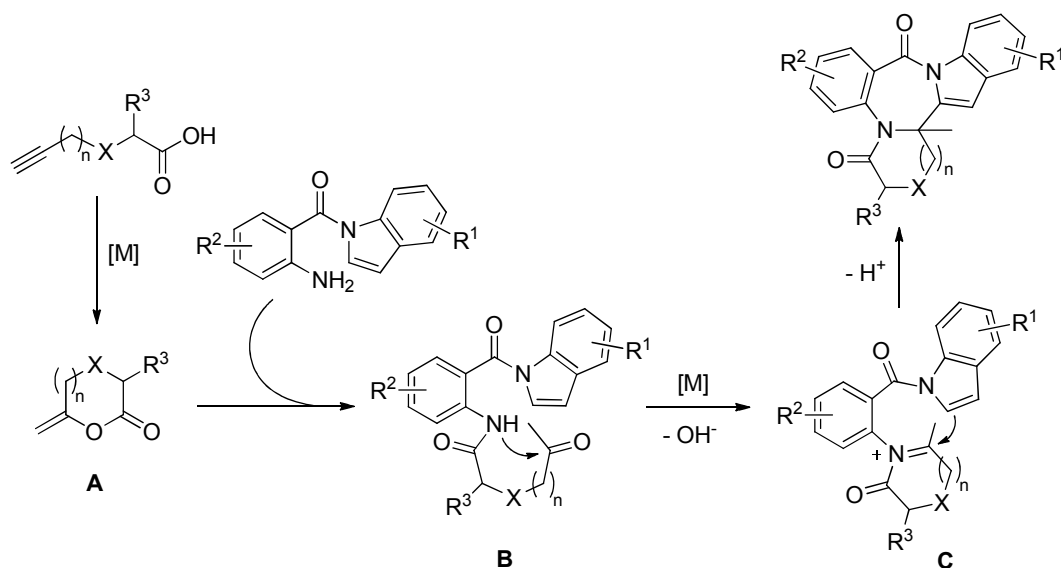

Scheme 88

On the whole, the strategy was tolerant of a broad range of substrates and afforded a series of interesting fused diazepinedione heterocycles. The author proposed a plausible mechanism, as described in Scheme 88. The catalyst would induce the cyclization of the alkynoic acid to generate the activated enolactone intermediate **A**, which is attacked by the amino group of *N*-(*o*-aminobenzoyl)indole to afford the ketoamide **B**. This was further converted to *N*-acyl iminium ion **C** by metal-assisted condensation. Finally, nucleophilic addition of indole C2 to *N*-acyl iminium ion **C** yields the ring-closure product. This hypothesis was supported by the isolation of the intermediate **B** in the reactions of less reactive substrates.

Using the same gold catalyst in the absence of silver salt, the same research group has recently developed a very interesting tandem hydroamination/hydroarylation reaction between *o*-(1-pyrrolyl-1-indolyl)anilines and alkynes (Scheme 89).⁹⁷

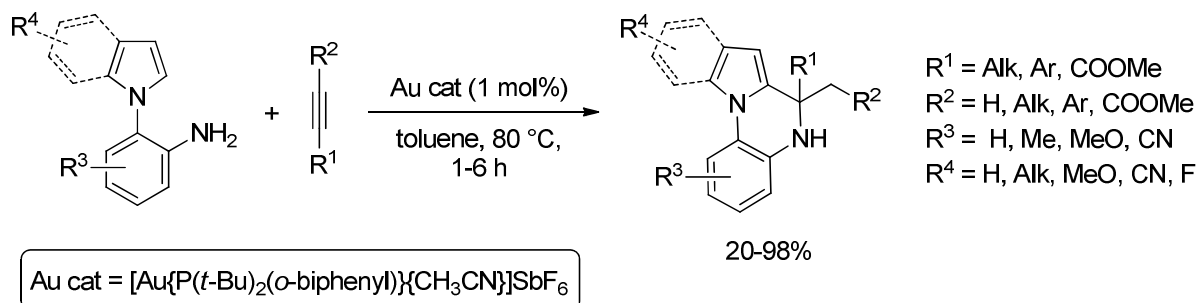

Scheme 89

The solvent of choice was toluene, but also ethanol and acetonitrile gave good results. Scope was broadly studied and the approach demonstrated to be effective with a variety of aromatic amino compounds and both the terminal and internal alkynes. Substituted pyrrolo/indolo[1,2-*a*]quinoxalines were obtained in moderate to excellent yields. In a single case, the 7-member ring-closure product was observed from the reaction of 2-(1*H*-pyrrol-1-yl)aniline and ethyl propiolate. Unfortunately, the mechanism was not properly discussed.

Polycyclic isoquinolines were synthesized by a quite similar approach through gold(I) catalyzed coupling-cyclization reactions of *o*-alkynylbenzaldehydes and aromatic amines bearing a tethered nucleophile. Optimization study driven up with 2-(phenylethynyl)benzaldehyde and 2-(1*H*-pyrrol-1-yl)aniline in the presence of Pt(II), Cu(II), Ag(I) and Au(I) catalysts, in various solvent/additive arrangements, revealed that in dichloroethane at room temperature and in the presence of AuCl (5 mol%) the reaction afforded 5-phenyl-4b,10b-dihydrobenzo[*i*]pyrrolo[1,2-*f*]phenanthridine in 96% yield (Scheme 90).⁹⁸

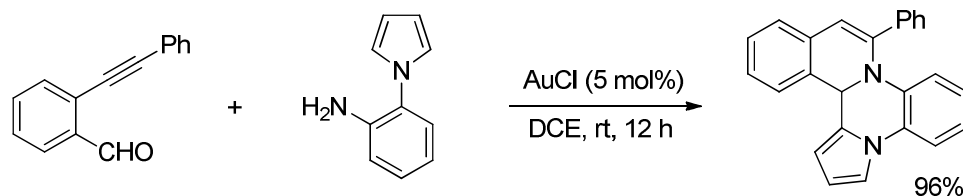

Scheme 90

The scope of this reaction was expanded synthesizing 33 polycyclic isoquinolines in moderate to excellent yields (55–96%). However, it should be noted that the reaction works only in the presence of internal alkynes and terminal alkynes are not viable substrates. The mechanism was explained assuming the

dual role exerted by gold(I) salts catalysts. Several experimental results indirectly confirmed the proposed path (Scheme 91).

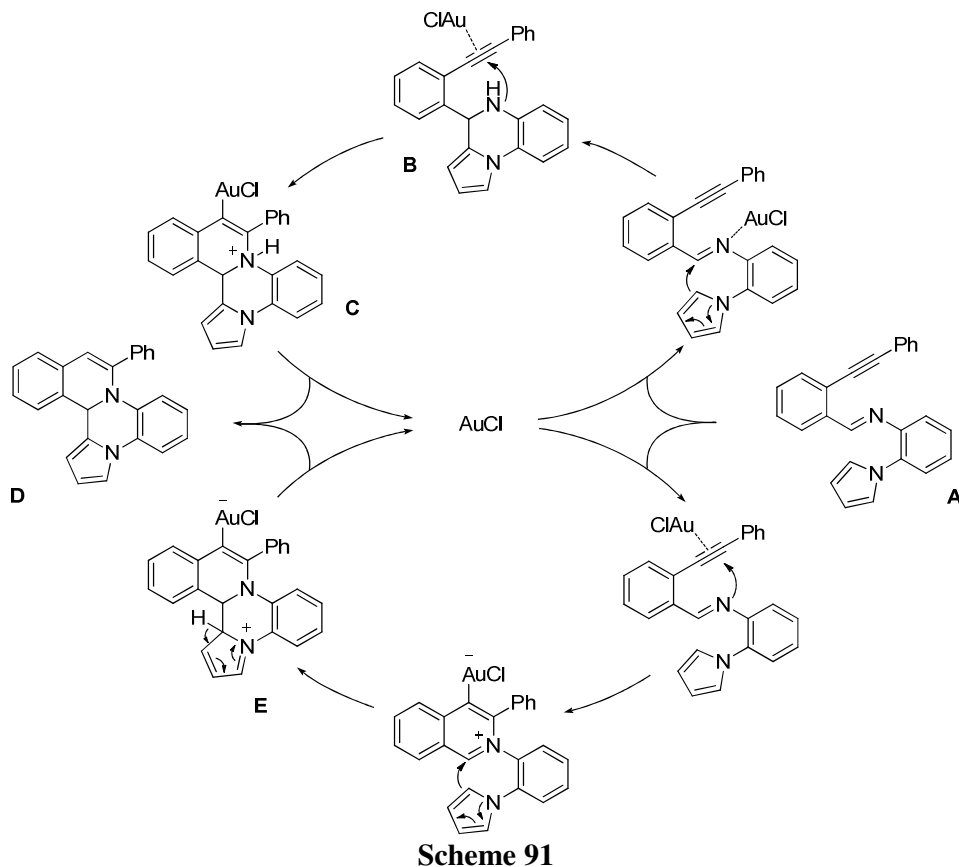

The proposed mechanism (Scheme 91) involves condensation between 2-(phenylethynyl)-benzaldehyde and 2-(1*H*-pyrrol-1-yl)aniline to give imine **A** which can be converted to the final product through a cascade process involving a Mannich-type reaction (σ -activation by gold (I) to give intermediate **B**) and a regiospecific intramolecular hydroamination reaction (π -activation by gold (I) to give intermediate **C**). Subsequent protonolysis of the C–Au bond delivers the final product **D** with regeneration of AuCl. To gain insight into the mechanism isolated imine **A** was subjected to gold catalysis under the standard conditions to give **D** in 97% yield, demonstrating that the proposed mechanism is operative and that addition of external additives (Brønsted or Lewis acids) was not necessary. However, in the absence of any direct evidence, an alternative or competitive mechanism involving an isoquinolinium ion, obtained by nucleophilic attack of the imine nitrogen atom at the gold coordinated alkyne [π -activation by gold (I)], which is trapped by the pyrrole to deliver **E** and successively **D** (and the free catalyst) by aromatization and protonolysis, cannot be ruled out (Scheme 91).

A domino strategy was applied to an efficient synthesis of bis(indolyl)methanes and di(indolyl)indolin-2-ones by a sequential one-flask gold(I) catalyzed approach involving cycloisomerization/bis-addition of *o*-ethynylanilines with various aldehydes and isatins, respectively (Scheme 92).⁹⁹

As reported in Scheme 93, the gold(I) catalyst acts as π -philic Lewis acid in the first step of the reaction and as σ -philic Lewis acid in the second one. The dual role of gold(I) and gold(III) catalysts has been reported by several authors¹ and is one of the most intriguing features of gold salts.

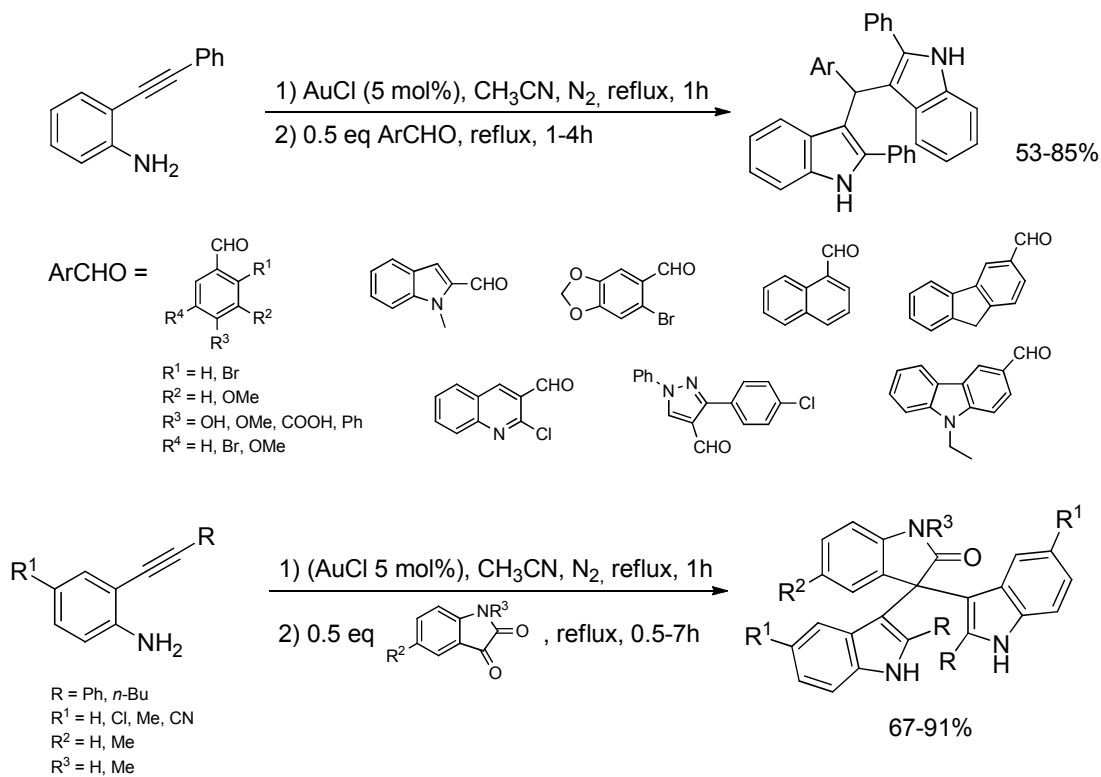

Scheme 92

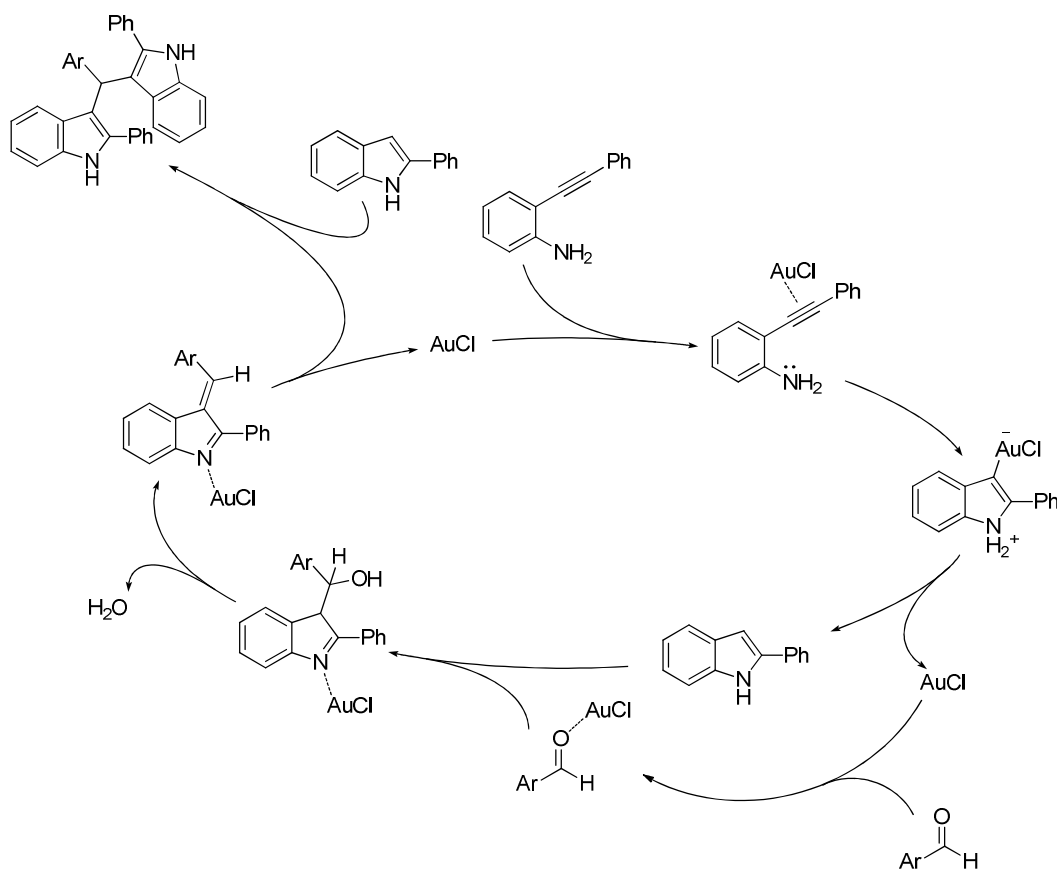

Scheme 93

Arcadi and coworkers realized a sequential hydroamination/conjugate addition of 2-alkynylphenylamines to α,β -enones affording 2,3-disubstituted indoles (Scheme 94).¹⁰⁰ The reaction worked well with a

wide range of substrates, except for strongly electrophilic enones and terminal alkynes, for which the cyclization step was too slow and an aza-Michael reaction prevailed affording secondary anilines, and for strongly electron-poor systems.

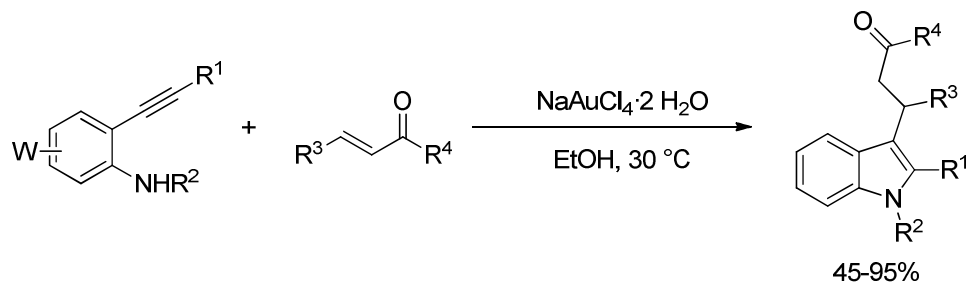

Scheme 94

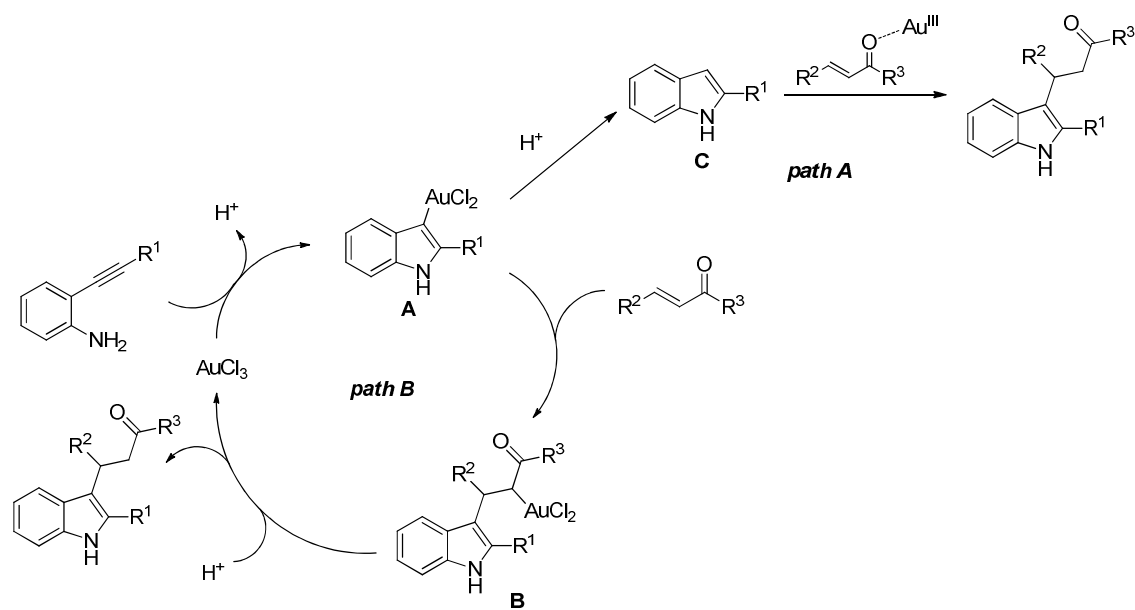

Scheme 95

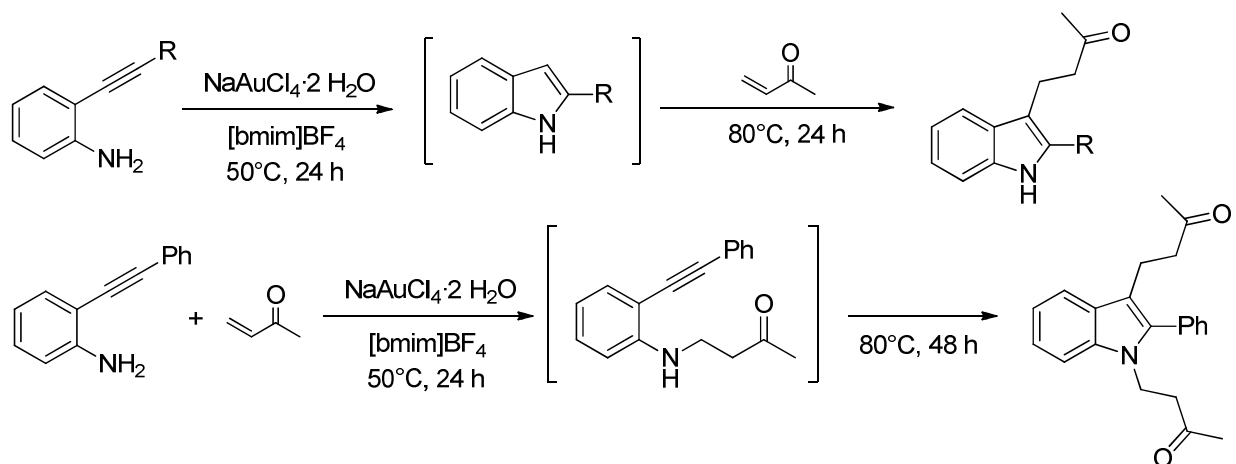

Scheme 96

As already mentioned, a direct attack of the arylgold intermediate to the α,β -enone or an hydroarylation pathway to the activated Michael acceptor are both possible (path a and b, Scheme 95). However,

path a was considered more likely. Notably, it requires a catalyst acting either as π - and σ -activator.

More recently, the same group developed a similar two-step reaction in the ionic liquid [bmim]BF₄ (bmim=1-butyl-3-methylimidazolium) as solvent (Scheme 96).¹⁰¹ Under these latter conditions, the one-flask protocol lead to the aza-Michael adduct.

8. Concluding remarks

Gold catalysis demonstrated to be a modern and powerful tool for the functionalization of heteroaromatic compounds. Despite only few examples on the reactivity of electron-poor heterocycles are reported, a lot of work has been done on reactions involving electron-rich heteroarenes, in particular pyrrole, furan and indole. The high structure complexity achievable, in general under mild reaction condition, is one of the most intriguing features of gold catalysis applied to heteroaromatic compounds. The dual activity of gold, *i.e.* its π - and σ -philic properties, is probably the key of its success as modern catalyst. Despite the exciting results till now obtained, the "golden age" is still "*at the height of its splendour*" and so much work can be done yet. In particular, the development of efficient gold catalyzed enantioselective transformations remains one of the more challenging goal for the near future.

References

1. Yamamoto, Y. *J. Org. Chem.* **2007**, *72*, 7817–7831.
2. (a) Hashmi, A. S. K. *Angew. Chem. Int. Ed.* **2010**, *49*, 5232–5241. (b) Shapiro, N. D.; Toste, F. D. *Synlett* **2010**, 675–691. (c) Hashmi, A. S. K. *Gold Bull.* **2009**, *42*, 275–279. (d) Hashmi, A. S. K. *Angew. Chem. Int. Ed.* **2008**, *47*, 6754–6756. (e) Hashmi, A. S. K. *Catalysis Today* **2007**, *122*, 211–214. (f) Gorin, D. J.; Toste, F. D. *Nature* **2007**, *446*, 395–403. (g) Hashmi, A. S. K.; Ata, F.; Bats, J. W.; Blanco, M. C.; Frey, W.; Hamzic, M.; Rudolph, M.; Salathe, R.; Schaefer, S.; Woelfle, M. *Gold Bull.* **2007**, *40*, 31–35. (h) Jimenez-Nunez, E.; Echavarren, A. M. *Chem. Commun.* **2007**, *4*, 333–346. See also 5e, 5k.
3. (a) Klahn, P.; Kirsch, S. F. *ChemCatChem* **2011**, *3*, 649–652. (b) Marion, N.; Nolan, S. P. *Chem. Soc. Rev.* **2008**, *37*, 1776–1782. (c) Gorin, D. J.; Sherry, B. D.; Toste, F. D. *Chem. Rev.* **2008**, *108*, 3351–3378.
4. (a) Nevado, C. *Chimia* **2010**, *64*, 247–251. (b) Gagosz, F. *Tetrahedron* **2009**, *65*, 1757–1767. (c) Arcadi, A. *Chem. Rev.* **2008**, *108*, 3266–3325. (d) Li, Z.; Brouwer, C.; He, C. *Chem. Rev.* **2008**, *108*, 3239–3265. (e) Hashmi, K. S. A.; Hutchings, G. J. *Angew. Chem. Int. Ed.* **2006**, *45*, 7896–7936.
5. From 2008 to 2011. For additions to C–C multiple bonds, see: (a) Huang, H.; Zhou, Y.; Liu, H. *Beil. J. Org. Chem.* **2011**, *7*, 897–936. (b) Bandini, M. *Chem. Soc. Rev.* **2011**, *40*, 1358–1367. (c) Xu, B.; Wang, W.; Liu, L.-P.; Han, J.; Jin, Z.; Hammond, G. B. *J. Organom. Chem.* **2010**, *696*, 269–276. For the synthesis of carbocycles and heterocycles, see: (d) Rudolph, M.; Hashmi, A. S. K. *Chem. Commun.* **2011**, *47*, 6536–6544. (e) Hashmi, A. S. K. *Pure Appl. Chem.* **2010**, *82*, 657–668. (f) Shen, H. C. *Tetrahedron* **2008**, *64*, 3885–3903. (g) Shen, H. C. *Tetrahedron* **2008**, *64*, 7847–7870. For asymmetric gold catalysis, see: (h) Pradal, A.; Toullec, P. Y.; Michelet, V. *Synthesis* **2011**, 1501–1514. (i) Sengupta, S.; Shi, X. *ChemCatChem* **2010**, *2*, 609–619. (j) Widenhoefer, R. A. *Chem. Eur. J.* **2008**, *14*, 5382–5391. (k) Bongers, N.; Krause, N. *Angew. Chem. Int. Ed.* **2008**, *47*, 2178–2181. For cycloisomerization reactions, see: (l) Belmont, P.; Parker, E. *Eur. J. Org. Chem.* **2009**, *35*, 6075–6089. For total synthesis: (m) Hashmi, A. S. K.; Rudolph, M. *Chem. Soc. Rev.* **2008**, *37*, 1766–1775.
6. Rueping, M.; Nachtsheim, B. J. *Beilstein J. Org. Chem.* **2010**, *6*, doi:10.3762/bjoc.6.6.
7. (a) Nicholas, K. M. *Acc. Chem. Res.* **1987**, *20*, 207–214. (b) Green, J. R. *Curr. Org. Chem.* **2001**, *5*, 809–826. (c) Teobald, B. J. *Tetrahedron* **2002**, *58*, 4133–4170.
8. Luzung, M. R.; Toste, D. F. *J. Am. Chem. Soc.* **2003**, *125*, 15760–15761.
9. Kuninobu, Y.; Ishii, E.; Takay, K. *Angew. Chem. Int. Ed.* **2007**, *46*, 3296–3299.

10. Georgy, M.; Bouchard, V.; Champagne, J.-M. *J. Am. Chem. Soc.* **2005**, *127*, 14180–14181.
11. Georgy, M.; Bouchard, V.; Debleds, O.; Dal Zotto, C.; Champagne, J.-M. *Tetrahedron* **2009**, *65*, 1758–1766.
12. Lee, K. Y.; Lee, H. S.; Kim, H. S.; Kim, J. N. *Bull. Korean Chem. Soc.* **2008**, *29*, 1441–1442.
13. Haug, T. T.; Harschneck, T.; Duschek, A.; Lee, C.-U.; Bibder, J. T.; Menz, H.; Kirsch, S. F. *J. Organomet. Chem.* **2009**, *694*, 510–514.
14. (a) *Comprehensive Organic Transformations*; Larock, R. C., Ed.; VCH: New York, 1999. (b) *Friedel-Crafts Alkylation Chemistry. A Century of Discovery*; Roberts, R. M.; Khalaf, A. A., Eds.; Dekker: New York, 1984. (c) *Friedel-Crafts and Related Reactions*; Olah, G. A., Ed.; Wiley-Intersciences: New York, 1964.
15. For Sc(OTf)₃-catalyzed examples, see: (a) Tsuchimoto, T.; Tobita, K.; Fukuzawa, S. *J. Org. Chem.* **1997**, *62*, 6997–7005. (b) Tsuchimoto, T.; Tobita, K.; Fukuzawa, S. *Synlett* **1996**, 557–559.
16. Rao, W.; Chan, P. W. H. *Org. Biomol. Chem.* **2008**, *6*, 2426–2433.
17. Bandini, M.; Eichholzer, A. *Angew. Chem. Int. Ed.* **2009**, *48*, 9533–9537.
18. Bandini, M.; Gualandi, A.; Monari, M.; Romaniello, A.; Savoia, D.; Tragni, M. *J. Organomet. Chem.* **2011**, *696*, 338–347.
19. Trost, B. M.; Van Vranken, D. L. *Chem. Rev.* **1996**, *96*, 395–422.
20. Mertins, K.; Iovel, I.; Kischel, J.; Zapf, A.; Beller, M. *Adv. Synth. Catal.* **2006**, *348*, 691–695.
21. Liu, J.; Muth, E.; Flörke, U.; Henkel, G.; Merz, K.; Sauvageau, J.; Schwake, E.; Dyker, G. *Adv. Synth. Catal.* **2006**, *348*, 456–462.
22. Rubenbauer, P.; Bach, T. *Adv. Synth. Catal.* **2008**, *350*, 1125–1130.
23. (a) Mühltau, F.; Stadler, D.; Goepfert, A.; Olah, G. A.; Prakash, G. K. S.; Bach, T. *J. Am. Chem. Soc.* **2006**, *128*, 9668–9675. (b) Stadler, D.; Bach, T. *Chem. Asian J.* **2008**, *3*, 272–284.
24. (a) Nair, V.; Thomas, S.; Mathew, S. C.; Abhilash, K. G. *Tetrahedron* **2006**, *62*, 6731–6747. (b) Muthyala, R.; Katrizky, A. R.; Lan, X. *Dyes Pigm.* **1994**, *25*, 303–324.
25. Shchepinov, M. S.; Korshun, V. A. *Chem. Soc. Rev.* **2003**, *32*, 170–180.
26. Podder, S.; Choudhury, J.; Roy, U. K.; Roy, S. *J. Org. Chem.* **2007**, *72*, 3100–3103.
27. Esquivias, J.; Arraya's, R. G.; Carretero, J. C. *Angew. Chem. Int. Ed.* **2006**, *45*, 629–633.
28. Li, Z.; Duan, Z.; Kang, J.; Wang, H.; Yu, L.; Wu, Y. *Tetrahedron* **2008**, *64*, 1924–1930.
29. Hashmi, A. S. K.; Schwarz, L.; Rubenbauer, P.; Blanco, M. C. *Adv. Synth. Catal.* **2006**, *348*, 705–708.
30. (a) Nair, V.; Abhilash, K. G.; Vidya, N. *Org. Lett.* **2005**, *7*, 5857–5859. (b) Nair, V.; Abhilash, K. G.; Vidya, N. *Synthesis* **2006**, 3647–3653.
31. (a) Dyker, G.; Muth, E.; Hashmi, A. S. K.; Ding, L. *Adv. Synth. Catal.* **2003**, *345*, 1247–1252. (b) Hashmi, A. S. K.; Schwarz, L.; Choi, J.-H.; Frost, T. M. *Angew. Chem. Int. Ed.* **2000**, *39*, 2285–2288.
32. Arcadi, A.; Alfonsi, M.; Bianchi, G.; D'Anniballe, G.; Marinelli, F. *Adv. Synth. Catal.* **2006**, *348*, 331–338.
33. Reetz, M. T.; Sommer, K. *Eur. J. Org. Chem.* **2003**, 3485–3496.
34. Li, Z.; Shi, Z.; He, C. *J. Organomet. Chem.* **2005**, *690*, 5049–5054.
35. Hashmi, A. S. K.; Salathé, R.; Frey, W. *Eur. J. Org. Chem.* **2007**, 1648–1652.
36. Menon, R. S.; Banwell, M. G. *Org. Biomol. Chem.* **2010**, *8*, 5483–5485.
37. Alfonsi, M.; Arcadi, A.; Bianchi, G.; Marinelli, F.; Nardini, A. *Eur. J. Org. Chem.* **2006**, 2393–2402.
38. Nair, V.; Vidya, N.; Abhilash, K. G. *Tetrahedron Lett.* **2006**, *47*, 2871–2873.
39. Aguilar, D.; Contel, M.; Navarro, R.; Urriolabeitia, E. P. *Organometallics* **2007**, *26*, 4304–4611.
40. Aguilar, D.; Contel, M.; Navarro, R.; Soler, T.; Urriolabeitia, E. P. *J. Organomet. Chem.* **2009**, *694*, 486–493.
41. Wang, M.-Z.; Wong, M.-K.; Che, C.-M. *Chem. Eur. J.* **2008**, *14*, 8353–8364.
42. Xiao, Y.-P.; Liu, X.-Y.; Che, C.-M. *J. Organomet. Chem.* **2009**, *694*, 494–501.
43. Troups, K. L.; Liu, G. T.; Widenhofer, R. A. *J. Organomet. Chem.* **2009**, *694*, 571–575.
44. (a) Zhang, Z.; Widenhofer, R. A. *Org. Lett.* **2008**, *10*, 2079–2081. (b) Kinder, R. E.; Zhang, Z.; Widenhofer, R. A. *Org. Lett.* **2008**, *10*, 3157–3159.
45. Zhang, Z.; Liu, C.; Kinder, R. E.; Han, X.; Qian, H.; Widenhofer, R. A. *J. Am. Chem. Soc.* **2006**, *128*, 9066–9073.
46. Liu, C.; Widenhofer, R. A. *Org. Lett.* **2007**, *9*, 1935–1938.

47. Alcaide, B.; Almendros, P.; Alonso, J. M.; Quirós, M. T.; Gadziński, P. *Adv. Synth. Catal.* **2011**, *353*, 1871–1876.
48. Barluenga, J.; Piedrafita, M.; Ballesteros, A.; Suárez-Sobrino, Á. L.; Gonzáles, J. M. *Chem. Eur. J.* **2010**, *16*, 11827–11831.
49. Zeldin, R. M.; Toste, F. D. *Chem. Sci.* **2011**, *2*, 1706–1709.
50. (a) England, D. B.; Padwa, A. *Org. Lett.* **2008**, *10*, 3631–3634. (b) Verniest, G.; England, D.; De Kimpe, N.; Padwa, A. *Tetrahedron* **2010**, *66*, 1496–1502.
51. Hashmi, A. S. K.; Weyrauch, J. P.; Frey, W.; Bats, J. W. *Org. Lett.* **2004**, *6*, 4391–4394.
52. (a) Ferrer, C.; Echavarren, A. M. *Angew. Chem. Int. Ed.* **2006**, *45*, 1105–1109. (b) Ferrer, C.; Amijs, C. H. M.; Echavarren, A. M. *Chem. Eur. J.* **2007**, *13*, 1358–1373.
53. Gruit, M.; Michalik, D.; Krüger, K.; Spannenberg, A.; Tillack, A.; Pews-Davtyan, A.; Beller, M. *Tetrahedron* **2010**, *66*, 3341–3352.
54. Seregin, I. V.; Gevorgyan, V. *J. Am. Chem. Soc.* **2006**, *128*, 12050–12051.
55. Barluenga, J.; Fernández, A.; Rodríguez, F.; Fañanás, F. J. *J. Organomet. Chem.* **2009**, *694*, 546–550.
56. Praveen, C.; Perumal, P. T. *Synlett* **2011**, *4*, 521–524.
57. Zhang, Y.-Q.; Zhu, D.-Y.; Jiao, Z.-W.; Li, B.-S.; Zhang, F.-M.; Tu, Y.-Q.; Bi, Z. *Org. Lett.* **2011**, *13*, 3458–3461.
58. Liu, X.; Xu, W.; Wang, X. *Org. Lett.* **2010**, *12*, 1448–1451.
59. Noey, E. L.; Wang, X.; Houk, K. N. *J. Org. Chem.* **2011**, *76*, 3477–3483.
60. Cera, G.; Crispino, P.; Monari, M.; Bandini, M. *Chem. Commun.* **2011**, *47*, 7803–7805.
61. Chinchilla, R.; Nájera, C. *Chem. Soc. Rev.* **2011**, *40*, 5084–5121.
62. Dudnik, A. S.; Gevorgyan, V. *Angew. Chem. Int. Ed.* **2010**, *49*, 2096–2098.
63. Liu, C.; Zhang, H.; Shi, W.; Lei, A. *Chem. Rev.* **2011**, *111*, 1780–1824.
64. Fuchita, Y.; Utsunomiya, Y.; Yasutake, M. *J. Chem. Soc., Dalton Trans.* **2001**, 2330–2334.
65. Brand, J. P.; Charpentier, J.; Waser, J. *Angew. Chem. Int. Ed.* **2009**, *48*, 9346–9349.
66. Brand, J. P.; Waser, J. *Angew. Chem. Int. Ed.* **2010**, *49*, 7304–7307.
67. Brand, J. P.; Chevalley, C.; Waser, J. *Beilstein J. Org. Chem.* **2011**, *7*, 565–569.
68. Praveen, G.; Karthikeyan, K.; Perumal, P. T. *Tetrahedron* **2009**, *65*, 9244–9255.
69. de Haro, T.; Nevado, C. *J. Am. Chem. Soc.* **2010**, *132*, 1512–1513.
70. Sanz, R.; Miguel, D.; Rodríguez, F. *Angew. Chem. Int. Ed.* **2008**, *47*, 7354–7357.
71. Marion, N.; Díez-González, S.; De Frémont, P.; Noble, A. R.; Nolan, S. P. *Angew. Chem. Int. Ed.* **2006**, *45*, 3647–3650.
72. Sanz, R.; Miguel, D.; Gohain, M.; García-García, P.; Fernández-Rodríguez, M. A.; González-Pérez, A.; Nieto-Faza, O.; de Lera, A. R.; Rodríguez, F. *Chem. Eur. J.* **2010**, *16*, 9818–9828.
73. Álvarez, E.; Miguel, D.; Garcia-Garcia, P.; Fernández-Rodríguez, M. A.; Rodríguez, F.; Sanz, R. *Beilstein J. Org. Chem.* **2011**, *7*, 786–793.
74. Sanz, R.; Miguel, D.; Álvarez-Gutiérrez, J. M.; Rodríguez, F. *Synlett* **2008**, 975–978.
75. Li, G.; Liu, Y. *J. Org. Chem.* **2010**, *75*, 3526–3528.
76. Lu, Y.; Du, X.; Jia, X.; Liu, Y. *Adv. Synth. Catal.* **2009**, *351*, 1517–1522.
77. For hydroxyl group-induced fragmentation, see: (a) Grob, C. A.; Schiess, P. W. *Angew. Chem. Int. Ed.* **1967**, *6*, 1–15. (b) Paquette, L. A.; Yang, J.; Long Y. O. *J. Am. Chem. Soc.* **2002**, *124*, 6542–6543.
78. Tietze, L. *Chem. Rev.* **1996**, *96*, 115–136.
79. (a) Walji, A. M.; MacMillan, D. W. C. *Synlett* **2007**, 1477–1489. (b) Chapman, C. J.; Frost, C. G. *Synthesis* **2007**, 1–21. (c) Wasilke, J.-C.; Obrey, S. J.; Baker, R. T.; Bazan, G. C. *Chem. Rev.* **2005**, *105*, 1001–1020.
80. (a) Arcadi, A.; Bianchi, G. *Targets in Heterocyclic Systems*; Attanasi, O. A.; Spinelli, D., Eds.; Società Chimica Italiana: Rome, 2004; Vol. 8, pp. 82–119. (b) Arcadi, A.; Di Giuseppe, S. *Curr. Org. Chem.* **2004**, *8*, 795–812.
81. Jimenez-Nunez, E.; Echavarren, A. M. *Chem. Rev.* **2008**, *108*, 3326–3350.
82. Zhang, L. *J. Am. Chem. Soc.* **2005**, *127*, 16804–16805.
83. Li, G.; Wang, E.; Chen, H.; Li, H.; Liu, Y.; Wang, P. G. *Tetrahedron* **2008**, *64*, 9033–9043.
84. Barluenga, J.; Fernández, A.; Rodríguez, F.; Fañanás, F. J. *Chem. Eur. J.* **2009**, *15*, 8121–8123.

85. (a) Toullec, P. Y.; Genin, E.; Leseurre, L.; Genêt, J.-P.; Michelet, V. *Angew. Chem. Int. Ed.* **2006**, *45*, 7427–7430. (b) Leseurre, L.; Chao, C.-M.; Seki, T.; Genin, E.; Toullec, P. Y.; Genêt, J.-P., Michelet, V. *Tetrahedron* **2009**, *65*, 1911–1918.
86. Chao, C.-M.; Vitale, M. R.; Toullec, P. Y.; Genêt, J.-P.; Michelet, V. *Chem. Eur. J.* **2009**, *15*, 1319–1323.
87. (a) Antoniotti, S.; Genin, E.; Michelet, V.; Genêt, J.-P. *J. Am. Chem. Soc.* **2005**, *127*, 9976–9977. (b) Nieto-Oberhuber, C.; Lopez, S.; Echavarren, A. M. *J. Am. Chem. Soc.* **2005**, *127*, 6178–6179.
88. Amiji, C. H. M.; Ferrer, C.; Echavarren, A. M. *Chem. Commun.* **2007**, 698–700.
89. Chen, Y.; Lu, Y.; Li, G.; Liu, Y. *Org. Lett.* **2009**, *11*, 3838–3841.
90. The formation of an analogous intermediate was postulated for Hashmi's phenol synthesis: Hashmi, A. S. K.; Rudolph, M.; Bats, J. W.; Frey, W.; Rominger, F.; Oeser, T. *Chem. Eur. J.* **2008**, *14*, 6672–6678.
91. Ji, K. G.; Shu, X. Z.; Chen, J.; Zhao, S.-C.; Zheng, Z.-J.; Liu, X.-Y.; Liang, Y.-M. *Org. Biomol. Chem.* **2009**, *7*, 2501–2505.
92. Shu, X. Z.; Liu, X.-Y.; Xiao, H.-Q.; Ji, K. G.; Guo, L.-N.; Qui, C.-Z.; Liang, Y.-M. *Adv. Synth. Catal.* **2007**, *349*, 2493–2498.
93. Yang, T.; Campbell, L.; Dixon, D. J. *J. Am. Chem. Soc.* **2007**, *129*, 12070–12071.
94. (a) Genin, E.; Toullec, P. Y.; Antoniotti, S.; Brancour, C.; Genêt, J.-P.; Michelet, V. *J. Am. Chem. Soc.* **2006**, *128*, 3112–3113. (b) Harkat, H.; Weibel, J. M.; Pale, P. *Tetrahedron Lett.* **2006**, *47*, 6273–6276.
95. Muratore, M. E.; Holloway, C. A.; Pilling, A. W.; Ian Storer, R.; Trevitt, G.; Dixon, D. J. *J. Am. Chem. Soc.* **2009**, *131*, 10796–10797.
96. Zhou, Y.; Li, J.; Ji, X.; Zhou, W.; Zhang, X.; Qian, W.; Jiang, H.; Liu, H. *J. Org. Chem.* **2011**, *76*, 1239–1249.
97. Liu, G.; Zhou, Y.; Lin, D.; Wang, J.; Zhang, L.; Jiang, H.; Liu, H. *ACS Comb. Sci.* **2011**, *13*, 209–213.
98. Patil, N. T.; Kumar Mutyala, A.; Lakshmi, P. G. V. V. *Eur. J. Org. Chem.* **2010**, 1999–2007.
99. Praveen, C.; Wilson Sagayaraj, Y.; Perumal, P. T. *Tetrahedron Lett.* **2009**, *50*, 644–647.
100. Alfonsi, M.; Arcadi, A.; Aschi, M.; Bianchi, G.; Marinelli, F. *J. Org. Chem.* **2005**, *70*, 2265–2273.
101. Ambrogio, I.; Arcadi, A.; Cacchi, S.; Fabrizi, G.; Marinelli, F. *Synlett* **2007**, *11*, 1775–1779.

STEREOSELECTIVE MULTICOMPONENT REACTIONS: FROM SIMPLE 1,3-DICARBONYLS TO FUNCTIONALIZED CHIRAL HETEROCYCLES

Damien Bonne, Yoann Coquerel, Thierry Constantieux and Jean Rodriguez*

Aix-Marseille Université – Institut des Sciences Moléculaires de Marseille UMR CNRS 7313 iSm2, Centre Saint Jérôme, Service 531, F-13397, Marseille Cedex 20, France (e-mail: jean.rodriguez@univ-amu.fr)

Abstract. *Multicomponent approaches to heterocycles are powerful strategies since they allow the fast generation of high complexity and diversity in the final products. This review focuses on the use of 1,3-dicarbonyl compounds as extraordinary synthetic platforms in stereoselective multicomponent reactions (MCRs) for the synthesis of functionalized chiral heterocycles. Indeed, the last five years have witnessed the emergence of new and innovative methodologies especially in enantioselective organocatalysis that will, without any doubt, find applications both in academical and industrial domains.*

Contents

1. Introduction
2. Diastereoselective multicomponent reactions
 - 2.1. MCRs based on the Hantzsch reaction
 - 2.2. MCRs based on the Biginelli reaction
 - 2.3. MCRs based on the Mannich reaction
 - 2.4. MCRs based on the Knoevenagel reaction
 - 2.5. MCRs based on the Michael addition
 - 2.6. MCRs based on Wolff rearrangement
3. Enantioselective multicomponent reactions

4. Conclusion

Acknowledgments

References

1. Introduction

In modern organic chemistry, creation of molecular complexity and diversity from simple substrates, while combining economic aspects with environmental ones, constitutes a great challenge, both from academic and industrial points of view.¹ Indeed, the efficiency of a chemical synthesis can be measured not only by parameters such as selectivity and overall yield, of course, but also by its raw materials, time, human resources, and energy requirements, as well as the toxicity and hazard of the involved chemicals and protocols. Over all, it is now recognized that step count is one of the most important criteria when evaluating the efficiency of the synthesis of complex molecules, too many of them being often hampered by the use of many protecting groups and/or the need of several purification steps.

This explains the high concern of synthetic chemists to develop new methodologies involving *multiple bond-forming transformations* (MBFTs)² and green *catalytic processes*.³ In this context, multicomponent reactions (MCRs)⁴ are particularly well adapted tools to answer the requirements of present and future organic synthesis. These methodologies allow molecular complexity and diversity to be created by the facile

formation of several new covalent bonds in a one-pot transformation, quite closely approaching the concept of an ideal synthesis.⁵ They have been used either for the generation of libraries of bioactive molecules⁶ or more recently employed as efficient tools in total synthesis of natural products.⁷ Some families of densely functionalized small molecules are particularly suited for use in these reactions. In this context, simple 1,3-dicarbonyl compounds are exceptional synthetic platforms due to the presence of four contiguous reaction sites and have been involved in an impressive number of powerful bimolecular synthetic transformations leading to complex structures. They also constitute one of the first substrate classes involved in a MCR with Hantzsch's dihydropyridine synthesis reported in 1882.⁸ Since then MCRs involving the reactivity of 1,3-dicarbonyls have grown impressively and emerged nowadays as one of the most efficient approaches in modern synthetic chemistry with a wide synthetic potential in heterocyclic chemistry.⁹

In this review, on the basis of selected examples, we will highlight the recent developments of 1,3-dicarbonyl compounds in stereoselective MCRs leading to chiral heterocyclic structures. The two main sections will cover diastereoselective and enantioselective MCRs, with an emphasis placed on work published in the last five years¹⁰ and are organized according to the nature of the reaction initiating the overall transformation.

2. Diastereoselective multicomponent reactions

2.1. MCRs based on the Hantzsch reaction

Dissymmetric 1,4-dihydropyridines (1,4-DHPs) bearing one stereogenic centre can be easily obtained by modified three-component Hantzsch's reaction between 1,3-dicarbonyls, aldehydes and functionalized primary amines. Several diastereoselective approaches have been studied for the preparation of optically active 1,4-DHPs and the use of one of the partners under enantiomerically pure form may be a solution.¹¹ Another efficient synthesis of unsymmetrical DHPs relies on the condensation between chiral aldehydes and 1,3-dicarbonyls in the presence of a preformed enamino ester intermediate. Thus, starting from a furano-aldehyde and an enamino ester, the asymmetric synthesis of 1,4-DHP *C*-glycoconjugate was achieved.¹² The same group developed the first organocatalyzed *C*-glycosyl aldehyde **1**–1,3-diketone–enamino ester **2** three-component variant of the Hantzsch reaction, leading to the formation of symmetrically and unsymmetrically substituted DHP *C*-glycoconjugates **3** of biological relevance, with excellent diastereomeric excesses even if the relative stereochemistry of the final product was not determined (Scheme 1).¹³

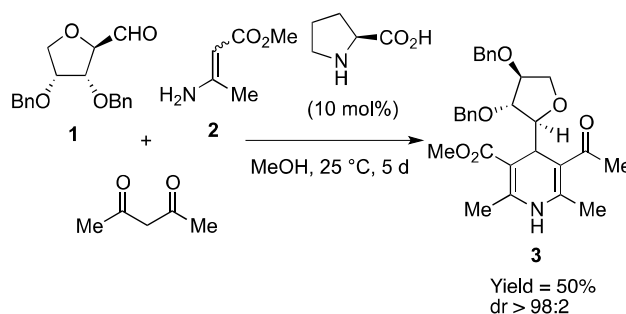

Scheme 1

This modified Hantzsch approach has recently been exploited for the stereoselective synthesis of pyrazolo[4,3-*c*]quinolizin-9-ones **5** (Scheme 2).¹⁴ Microwave irradiation of a mixture of dimedone, aminopyrazole **4** and aromatic aldehyde in the presence of *t*-BuOK led to these heterocyclic compounds in

moderate to good yields but with a total diastereoselectivity. The unsymmetrical Hantzsch intermediate **6** undergoes a ring-opening step followed by an intramolecular transamidation to give finally tricyclic compound **5**.

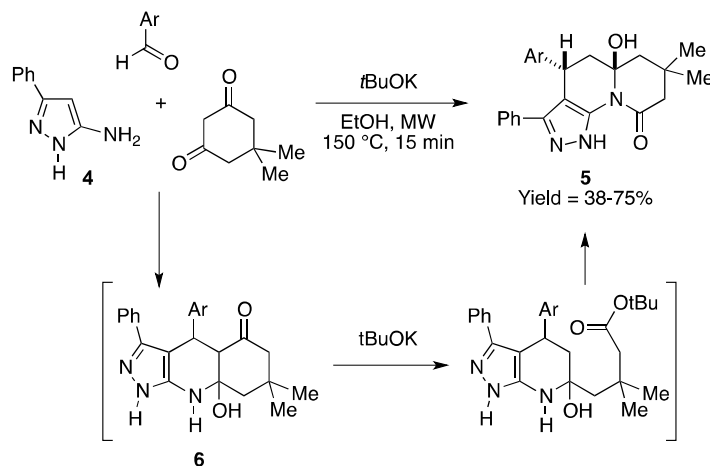

Scheme 2

Finally, when the enamine partner is replaced by a guanidine system, the modified MCR evolves through a Knoevenagel-aza-Michael sequence, leading to polyheterocycles **8** of biological interest (Scheme 3).¹⁵ Thus, the condensation of 2-amino-1,3,4-triazole **7**, an aldehyde and a 1,3-dicarbonyl substrate in water at room temperature afforded the corresponding bicyclic hemiaminals **8** in moderate to good yields. It is noteworthy that in most of the cases, only one of the four possible diastereomers bearing three contiguous stereogenic centres is formed in this environmentally benign catalyst-free sequence.

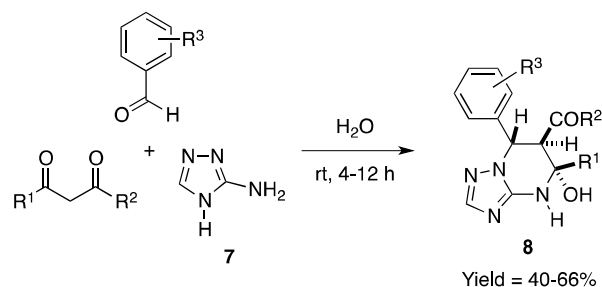

Scheme 3

2.2. MCRs based on the Biginelli reaction

The Biginelli reaction, discovered by Pietro Biginelli in 1893,¹⁶ is a MCR allowing the synthesis of 3,4-dihydropyrimidin-2-(1*H*)-ones or -thiones (DHPMs) by reacting an urea or thiourea, a 1,3-dicarbonyl derivative and an aldehyde. The increasing interest in DHPMs providing a large diversity of new synthetic methodologies¹⁷ is mainly due to their therapeutic and pharmacological properties.¹⁸

Biginelli products contain a stereogenic centre and the influence of the absolute configuration on the biological activity has been investigated. Indeed, as two enantiomers may perform different or even opposite activities,¹⁹ the development of representative methods to approach enantioenriched DHPMs is a task of primary importance.²⁰ For example, optically active DHPMs **10** can be prepared through auxiliary-assisted asymmetric Biginelli synthesis, using chiral starting materials such as a *C*-glycosyl β -ketoester **9** (Scheme 4).^{12a}

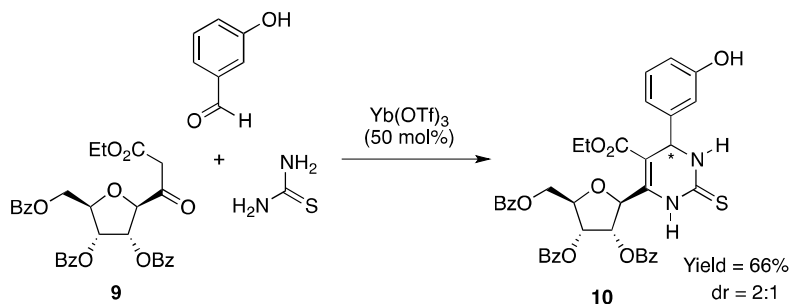

Scheme 4

2.3. MCRs based on the Mannich reaction

The Mannich reaction consists on the condensation of a C–H-activated compound with a primary or a secondary amine and a non-enolizable aldehyde or ketone to afford β -aminocarbonyl derivatives known as Mannich bases.²¹ This sequence is of great use for the construction of cyclic and acyclic nitrogen-containing molecules and numerous variants have been published. Among them, the CoCl_2 -catalyzed coupling between a 1,3-dicarbonyl compound, an aromatic aldehyde, and acetonitrile in the presence of acetyl chloride,²² provides a general access to β -acetamido carbonyl compounds **11** bearing two stereogenic centres (Scheme 5).

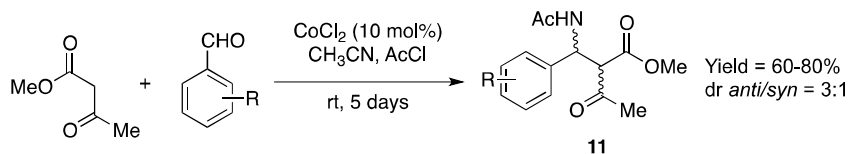

Scheme 5

A large number of catalysts have been reported for this reaction, with a diastereomeric ratio ranging from 50/50 to 98/2.²³ These products are the building blocks of numerous pharmaceutical and biological compounds and they can be used as precursors of 1,3-amino alcohols,²⁴ β -amino acids²² and γ -lactams.²⁵ Recently, selectfluor[®] has been described as an efficient green catalyst for this transformation, offering advantages such as shorter reaction times and high *anti*-selectivity, especially from α -substituted ketones.²⁶ Finally, a variant was reported recently involving acetamide in the presence of trimethylchlorosilane.²⁷ The latter compound acts as a Lewis acid for activation of the aldehyde partner.

The Mannich reaction is also of great use for the construction of heterocyclic targets, as illustrated by the recent reports on the stereoselective synthesis of 1,4-diazepane derivatives **15** (Scheme 6). Kita's group²⁸ and our group^{29,30} independently reported a cyclodehydrative three-component synthesis of these heterocyclic seven-membered rings of biological interest from cyclic 1,3-dicarbonyl compounds **12**, aromatic aldehydes and 1,2-diamines **13**. The reaction involves the formation of an intermediate **14** bearing imine and enamino ester functionalities, which then evolves to the final product *via* an intramolecular Mannich-type condensation. The latter step of the sequence corresponds to a γ -functionalization of the starting 1,3-dicarbonyl. The reaction may be conducted either in refluxing 1,2-dichloroethane in the presence of *p*-toluene sulfonic acid (method A)²⁸ or 4Å molecular sieves (method B)^{29,30} as catalyst or under solvent- and catalyst-free conditions (method C).^{29,30} The latter conditions were particularly efficient when β -keto-amides were used as substrates. It is noteworthy that 1,2-phenylenediamine was not effective in this MCR, but the access to the corresponding 1,5-benzodiazepine derivatives were made possible by the development

of a sequential one-pot protocol involving the preliminary acid-catalyzed formation of an enamino ester from the 1,2-diamine and a 1,3-dicarbonyl.³¹

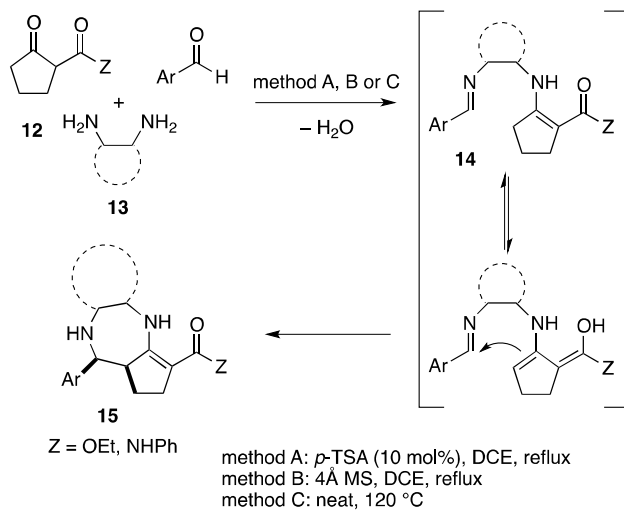

Scheme 6

Many piperidine-containing cores, both natural and synthetic, are of biological and medicinal interest. These heterocyclic scaffolds have been the subjects of considerable synthetic efforts, especially for the construction of optically active compounds. In this context, Khan *et al.* reported a three-component reaction with 1,3-dicarbonyls, aromatic aldehydes and aromatic amines catalyzed by bromodimethylsulfonium bromide (BDMS, **16**)³² or tetrabutylammonium tribromide (TBATB),³³ for a facile access to highly functionalized piperidines **17** featuring two stereogenic centres with the *trans* relationship, exclusively (Scheme 7). This strategy is an interesting illustration of quite rarely exploited potentialities of β -ketoesters to react both at α - and γ -positions with electrophiles for C–C bond formations.

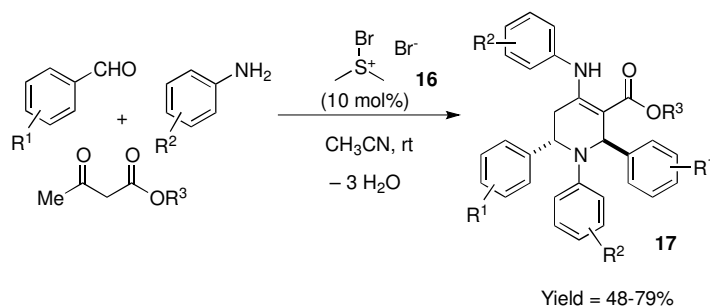

Scheme 7

2.4. MCRs based on the Knoevenagel reaction

The Knoevenagel reaction is the condensation of aldehydes or ketones with active methylene compounds, usually in the presence of a weakly basic amine.³⁴ The resulting highly reactive product **18** can undergo inverse demand hetero Diels–Alder reaction with a dienophile **19** to afford functionalized dihydropyrans **20** (Scheme 8). The overall transformation can be performed as a three-component reaction, known as the domino “Knoevenagel-hetero Diels–Alder reaction”, discovered and intensively studied by the group of Tietze.³⁵ As an illustration of its potentialities, this domino sequence was reported as a successful key-step in the first enantioselective syntheses of *Ipecacuanha* alkaloid emetine and *Alagium* alkaloid tubolisine.³⁶

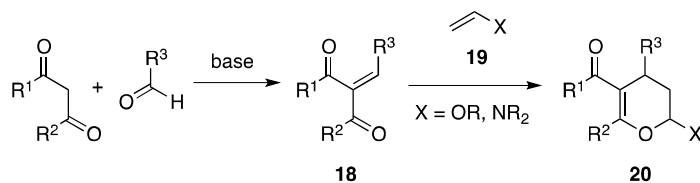

An interesting application concerns the regio- and diastereoselective construction of tri- and tetracyclic pyrano-1,4-benzoquinones **23** derived from embelin (**21**), formaldehyde and cyclic olefins **22** under catalyst-free microwave irradiation (Scheme 9).³⁷ An extension of this methodology has been proposed more recently for the synthesis of fused uracils using barbituric acid derivatives as 1,3-dicarbonyl in water with moderate *cis* selectivity.³⁸

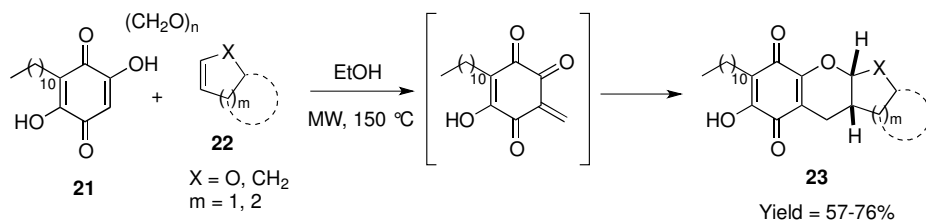

An interesting variant, is the organocatalyzed microwave-assisted Knoevenagel-hetero Diels–Alder reaction reported for the synthesis of 2,3-dihydropyran[2,3-*c*]pyrazoles **25** from pyrazol-2-one **24** as masked synthetic equivalent of 1,3-dicarbonyl (Scheme 10).³⁹ However, using proline derivatives as catalyst in *t*-BuOH, the two diastereomers of the desired product were isolated in good yields with a modest 4:1 diastereomeric ratio.

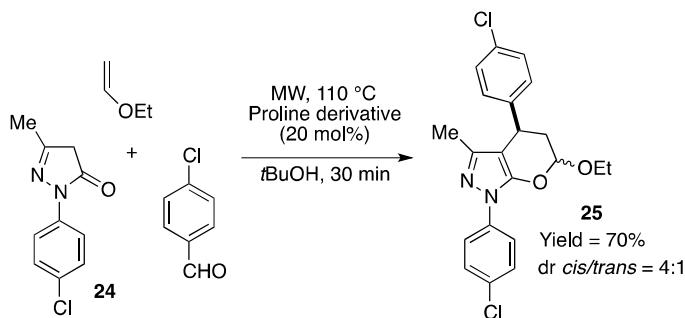

Another contribution to the domino Knoevenagel-hetero Diels–Alder reaction was reported by Li and co-workers involving Meldrum's acid (**26**), two molecules of aromatic aldehyde and either 5-aminopyrazole or 5-aminoisoxazole **27** (Scheme 11).⁴⁰ In water and under microwave irradiation, they could perform the clean synthesis of valuable spiroheterocycles **28** in good yields with excellent chemo-, regio- and diastereoselectivity.

Knoevenagel reaction has also been combined with 1,3-dipolar cycloaddition to allow the formation of challenging bispyrrolidine derivatives **32** (Scheme 12).⁴¹ A mixture of 1,3-indanedione **29**, an aldehyde, sarcosine (**30**) and a cyclic 1,2-dione **31** in refluxing ethanol without any catalyst gave bispyrrolidine derivatives **32** as a single diastereomer. This highly regio- and stereoselective four-component Knoevenagel-

Huisgen cycloaddition sequence is of great interest for the synthesis of such spiro pyrrolidines, which are potential antileukemic and anticonvulsant agents also exhibiting antiviral properties. A reasonable mechanism involves a two-fold role of sarcosine (**30**), which acts both as catalyst for the Knoevenagel condensation and as key-reaction partner for *in situ* formation of the dipolarophile **33**. Similar diastereoselective approaches to spirooxindoles have been developed recently by the groups of Ghandi⁴² and Ji⁴³ using 1,3-dipolar cycloaddition.

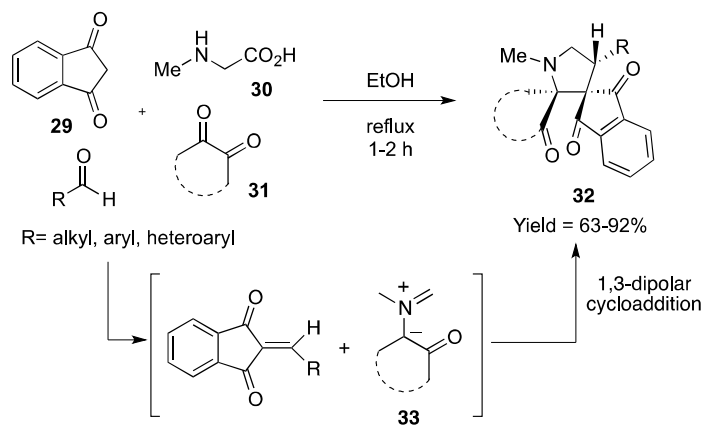
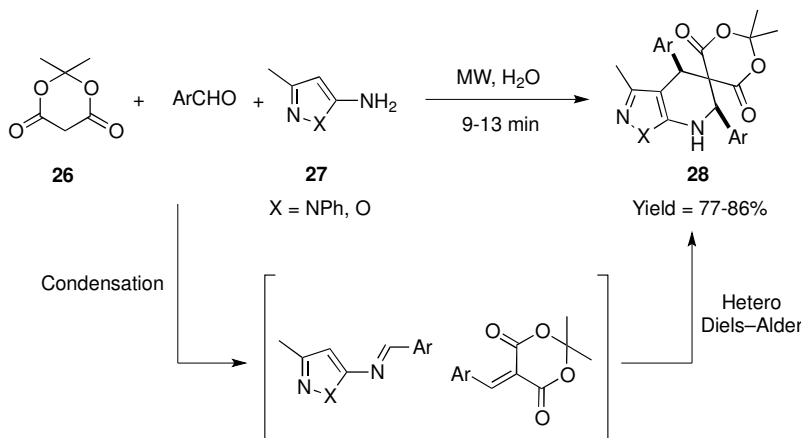

Alternatively, under specific conditions, using an aromatic aldehyde, 1,3-cyclohexandione (**34**) and acyclic trifluoro-1,3-diketones **35** in ethanol with catalytic amount of triethylamine, challenging cyclic hemiketals **36** were isolated in moderate to good yields with an excellent diastereoselectivity of the three created stereogenic centres through an interrupted Hantzsch reaction (Scheme 13).⁴⁴

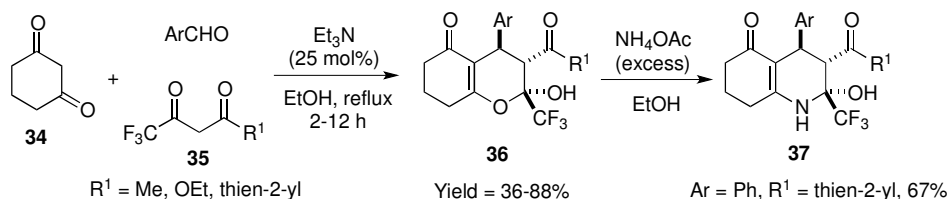

Although the overall *C–O*-cycloalkylation can be performed with various amine catalysts, the best results were obtained with triethylamine and the corresponding hexahydroquinolinone derivatives **37** could be formed in a four-component reaction with ammonium acetate. It was also noteworthy that aliphatic aldehydes as well as *ortho*-substituted arylaldehydes were unreactive under these conditions.

A related Knoevenagel/*C–O*-cycloalkylation sequence was recently reported for the simultaneous construction of two different fused heterocycles from acyclic precursors.⁴⁵ It concerns a four-component synthesis of dihydropyranopyrazole derivatives **38** from hydrazine hydrate, malonitrile, a β -ketoester and an aldehyde or a ketone (Scheme 14). The reaction was also described under catalyst- and solvent-free conditions or using piperidine in ultrapure aqueous media, both at room temperature. Interestingly enough, when a bulky aromatic aldehyde such as 2-methoxynaphtaldehyde was used, two atropoisomers were isolated in a 2:1 ratio.

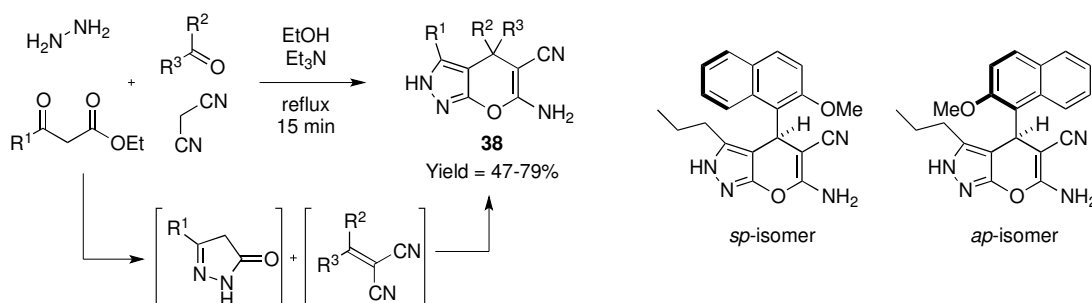

Scheme 14

Also of interest for the construction of oxygen containing heterocycles is the recent diastereoselective synthesis of tetrahydrobenzofuranones and dihydrofurocoumarins.⁴⁶ This involves heating of a mixture α -bromoacetate **39**, an aromatic aldehyde and either cyclohexan-1,3-diones **40** or 4-hydroxy-coumarin in the presence of pyridine and 1,4-diazabicyclo[2.2.2]octane as basic promoter (Scheme 15). The *in situ* formation of pyridinium ylide is followed by a Michael addition to the Knoevenagel intermediate, which evolved through an intramolecular *O*-alkylation resulting in the selective formation of the *trans* heterocycles **41** in good yields.

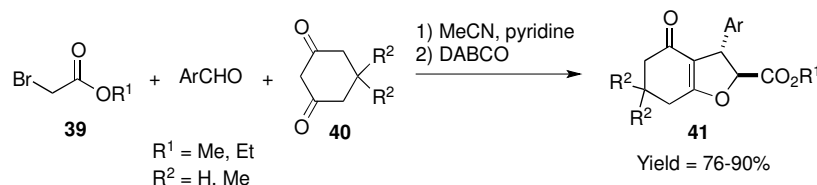

Scheme 15

A complementary peculiar transformation is the use of *tert*-butyl cyanomalonate (**42**) involved in a stereoselective four-component reaction leading to *trans*-2,3-dihydroaminothiophenes **44** when reacted with an aldehyde, an amine and thiazolidinedione (**43**) (Scheme 16).⁴⁷ After Michael addition of the thiazolidine-2,4-dione (**43**) to the Knoevenagel intermediate **45**, a chemoselective ring opening promoted by a secondary amine and addition of the resulting thiolate to the nitrile function of **46**, furnished the expected amino heterocycle **44** in moderate to good yields and with an excellent diastereoselectivity.

A related γ -arylidation initiated sequence was recently developed for the stereoselective synthesis of highly functionalized spiro piperidine-2,4-diones **48** bearing three contiguous stereogenic centres (Scheme

17).⁴⁸ The transformation is based on the specific reactivity of 1-acetylcyclopropanecarboxamides **47** toward arylaldehydes under basic conditions. In this pseudo three-component reaction the initially formed γ -arylidene intermediate **49** acts as a third component, in the last intermolecular Michael addition, after being transformed by an intramolecular aza-Michael addition generating the crucial cyclic enolate **50**.

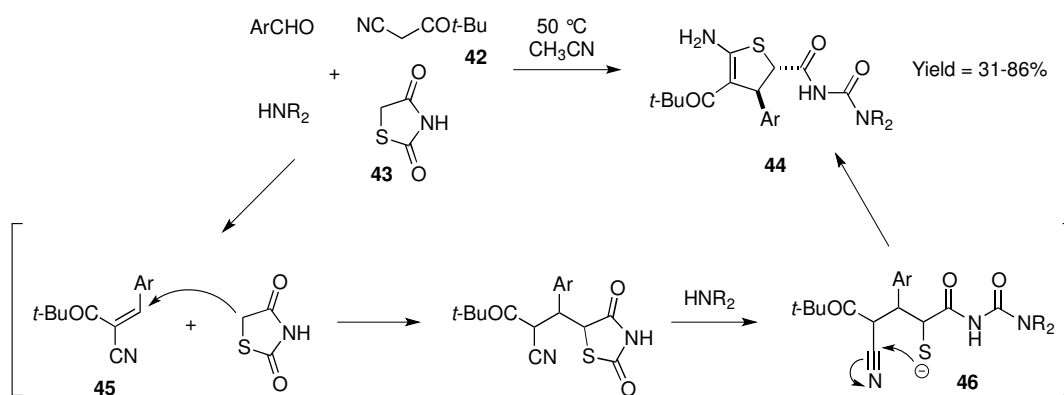

Scheme 16

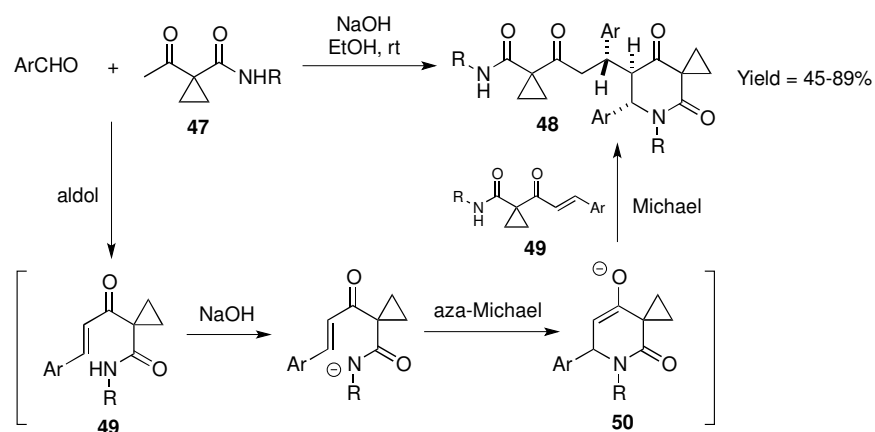

Scheme 17

Finally, the group of Adib recently developed a one-pot multicomponent diastereoselective synthesis of 3,4-disubstituted pyrrolidine-2,5-diones **53** from *N*-isocyaniminotriphenylphosphorane **51**, aldimines **52**, Meldrum's acid and water (Scheme 18).⁴⁹

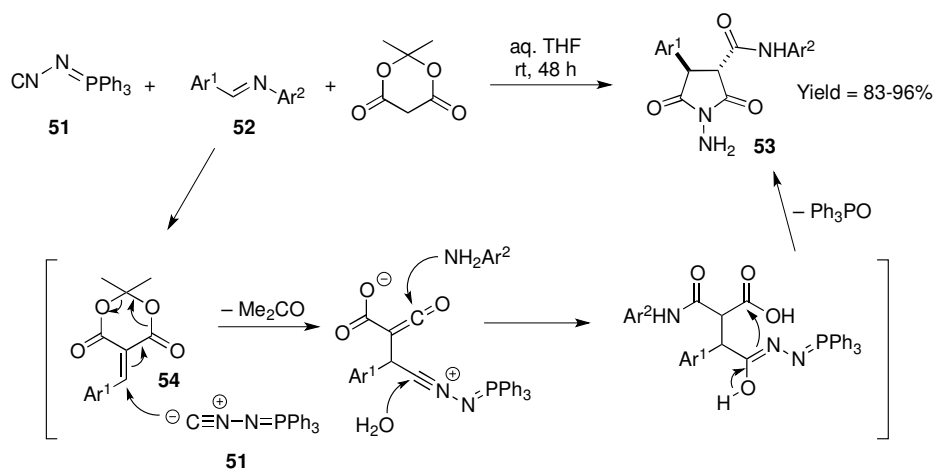

Scheme 18

The good to excellent yields of the products and mild reaction conditions are the main advantages of this method. In the reaction mechanism, the isonitrile **51** is the key-functionality as it is involved both in the Michael addition on the Knoevenagel intermediate **54** and in the heterocyclization step.

2.5. MCRs based on the Michael addition

Among the various pronucleophiles used in Michael additions, enolates derived from 1,3-dicarbonyl compounds are substrates of choice due to their easy deprotonation under mild conditions. Although this transformation is an old, but still very powerful and simple reaction, it came to be of interest for MCRs only recently⁵⁰ and has emerged as promising approach with a wide synthetic potential in heterocyclic synthesis.⁵¹

The first Michael addition-based MCR with 1,3-dicarbonyls was reported by Eschenmoser and co-workers in 1979 and since these pioneer results,⁵² such MCRs remained unexplored for over 20 years. In 2001, we developed the first MCR between 1,3-dicarbonyls, α,β -unsaturated aldehydes or ketones and ω -nucleophilic functionalized primary amines **54** in the presence of molecular sieves, providing a route to polyheterocyclic compounds of synthetic, biological and pharmaceutical interests (Scheme 19).⁵³ From a mechanistic point of view, the key-step of this sequence is the formation of an iminium intermediate **55** or **56**, which is trapped *in situ* by the nucleophilic function of the amine partner. The structure of the corresponding products is highly dependent of the nature of the amine.

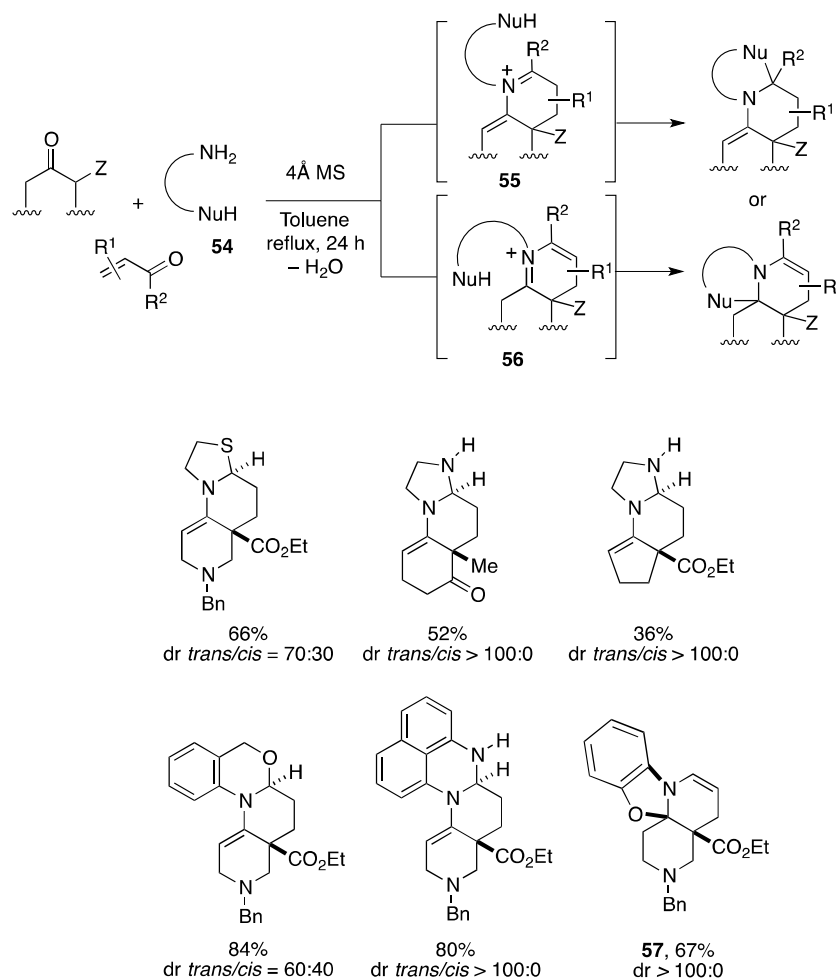

Scheme 19

Indeed, diamines, aminoalcohols and aminothiols led selectively to the formation of fused polyheterocyclic *N-N*-, *N-O*- and *N-S*-aminals with partial to total *anti* selectivity, while *o*-hydroxyaniline afforded a spiro-type tetracyclic compound **57** as a single diastereomer.

More recently, an extrapolation of this work was proposed for the three-component condensation of acrolein (**58**), (*S*)-2-phenylglycinol (**59**) and various acyclic 1,3-dicarbonyls in toluene in the presence of 4Å molecular sieves for the preparation of bicyclic functionalized tetrahydropyridines **60** with relatively moderate diastereoselectivity (Scheme 20).⁵⁴ These heterocycles may be used as chiral building blocks for the synthesis of alkaloids, as illustrated by the total synthesis of (–)-lupinine in five steps and 29% overall yield.

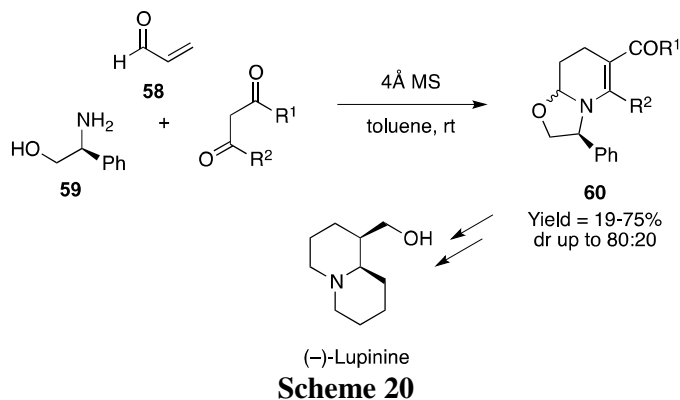

The introduction of a functionalized pyrrole **61** as the amine partner in this sequence allowed us to propose a highly efficient access to original pyrrolo-piperazine and azasteroid-like scaffolds. The key-step consists on the formation of an ene-iminium intermediate **62**, *in situ* trapped through a Pictet-Spengler-type cyclization. As an illustration of the stereoselective potential of this transformation, we were able to prepare a tetracyclic compound **63** with an azasteroid skeleton, in high yield and as a single 1,4-*trans* diastereomer (Scheme 21).⁵⁵

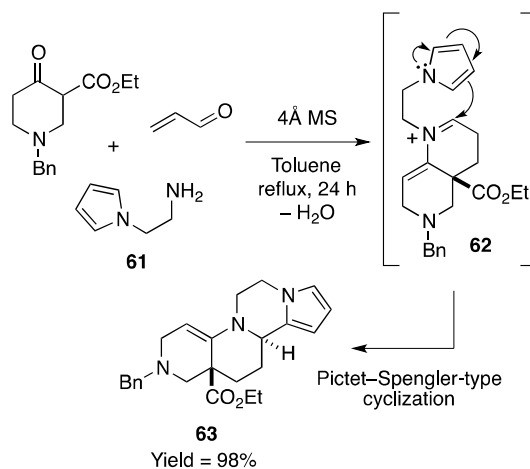

Finally, the highest level of complexity for this three-component reaction was reached when β -keto-amides **64** were used as substrates. We demonstrated that these particular 1,3-dicarbonyls could be involved not only as substrates but also as nucleophilic partners through the highly diastereoselective synthesis of

scaffolds **65** containing an original 2,6-diazabicyclo[2.2.2]octane skeleton (2,6-DABCO).⁵⁶ In this transformation, two different iminium intermediates **66** and **67** were successively generated and trapped by two different nucleophiles, one being the substrate itself and the other one resulting from the hetero-functionalization of the amine partner (Scheme 22).

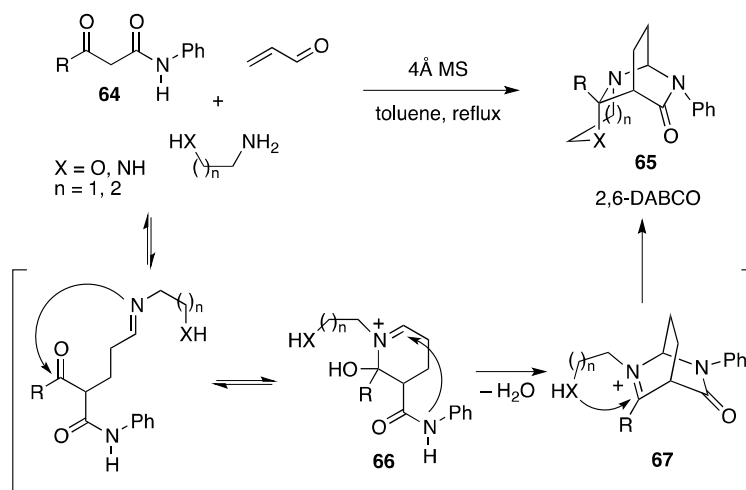

Scheme 22

Starting from quite similar substrates, *i.e.* alkylamines, β -ketoesters and unsaturated aldehydes, but replacing molecular sieves by CAN as catalyst in an alcohol, a four-component moderately diastereoselective synthesis of 6-alkoxy-2-methyl-1,4,5,6-tetrahydropyridines **68** was reported (Scheme 23).⁵⁷ From a mechanistic point of view, a Michael addition occurs between the enamino ester **69** derived from the 1,3-dicarbonyl and the unsaturated aldehyde, followed by an intramolecular cyclization leading to a 2-hydroxy-tetrahydropyridine derivative **70**. The latter compound is finally transformed into the observed product by nucleophilic substitution of the hydroxy group by the alcohol.

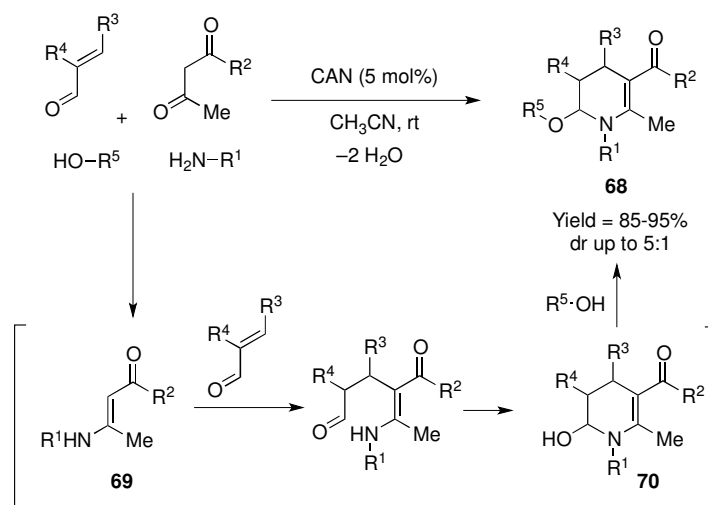

Scheme 23

Methanol has been also involved in a three-component sequence between β -ketoesters of type **71** and α,β -unsaturated aldehydes **72** promoting a retro-Dieckmann type fragmentation of the intermediate 8-oxobicyclo[3.2.1]octanes of type **75** to form the seven-membered rings **73** or **74** (Scheme 24).⁵⁸ The reversible

character of the two first elemental steps (Michael addition and aldolization) combined with a highly selective retro-Dieckmann fragmentation allow a highly diastereoselective access to a variety of poly-substituted and functionalized heterocyclic seven-membered rings incorporating either oxygen, nitrogen or sulfur heteroatoms starting from simple and cheap substrates under user and environmentally friendly conditions.⁵⁹

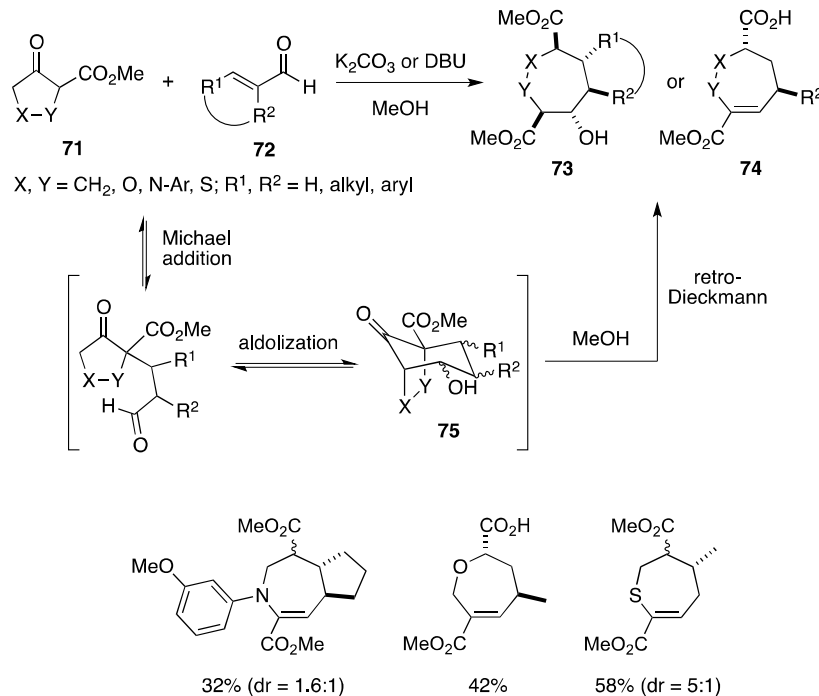

Scheme 24

In situ formation of 1,3-ketoamides from diketene (**76**) has been exploited by Alizadeh's group⁶⁰ in an efficient stereoselective four-component approach to (*Z*)-4,5-dihydro-1*H*-pyrrol-3-carboxamide derivatives **78**. The overall transformation involves two different primary amines and diketene (**76**) in the presence of dibenzoylacetylene (**77**) as the Michael acceptor (Scheme 25). The reaction was conducted under neutral conditions at room temperature for 6 hours to afford the desired products in high yields as a single (*Z*) isomer.

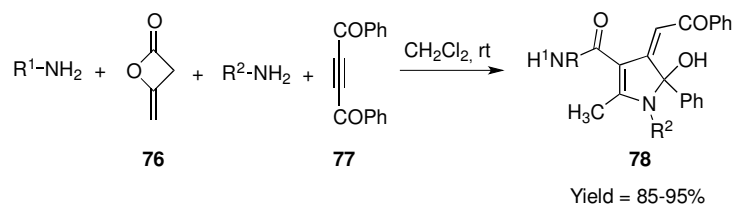

Scheme 25

Finally, other α -activated carbonyl compounds such as α -nitroketones have been used successfully in very interesting and novel MCRs. Our group proposed an unprecedented reactivity of α -nitroalkanones **79** towards 2-substituted acroleins **80** under aqueous conditions, with participation of water as third component.⁶¹ This three-component sequence led to the one-pot synthesis of hitherto unknown functionalized bridged bicyclic lactones containing 10-, 11-, 13- and 15-membered rings **81**, with a high

stereocontrol of the two newly created adjacent stereogenic centres (Scheme 26). One of the key-steps of this one-pot process consists of the fragmentation of the initial Michael adduct through a retro-Claisen-type reaction, initiated by water. It is interesting to note that such new heterocyclic structures can be considered as lactones derived from a tertiary alcohol, and would be difficult to make by other methods.

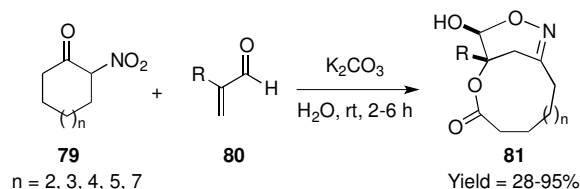

Scheme 26

2.6. MCRs based on Wolff rearrangement

In addition to their reactions with nucleophiles,⁶² α -oxo-ketene can react as 1,3-oxadienes in inverse demand hetero Diels–Alder reactions and this reactivity was exploited in a domino three-component synthesis of oxazinones. Thus, we were able to obtain stereoselectively oxazinones **83** from the microwave irradiation of a 1:1:1 mixture of 2-diazo-1,3-diketone **82**, an aldehyde and a primary amine (Scheme 27).⁶³ Under these conditions, the aldehyde and the amine partners react together to give the corresponding imine **85**, while the diazo compound undergoes the Wolff rearrangement to give the corresponding α -oxo-ketene **84**, which then react with the *in situ* generated imine **85**. With enantiopure primary branched amines a modest chiral induction was observed (*e.g.* **86**). In the case where both the aldehyde and amine partners were specifically chosen to participate in a subsequent intramolecular Diels–Alder reaction, the pentacyclic oxazinone derivative **87** was obtained allowing the stereocontrolled creation of six chemical bonds and four rings in a single catalyst-free reaction in fair to good yields in regards of the increase of the molecular complexity.

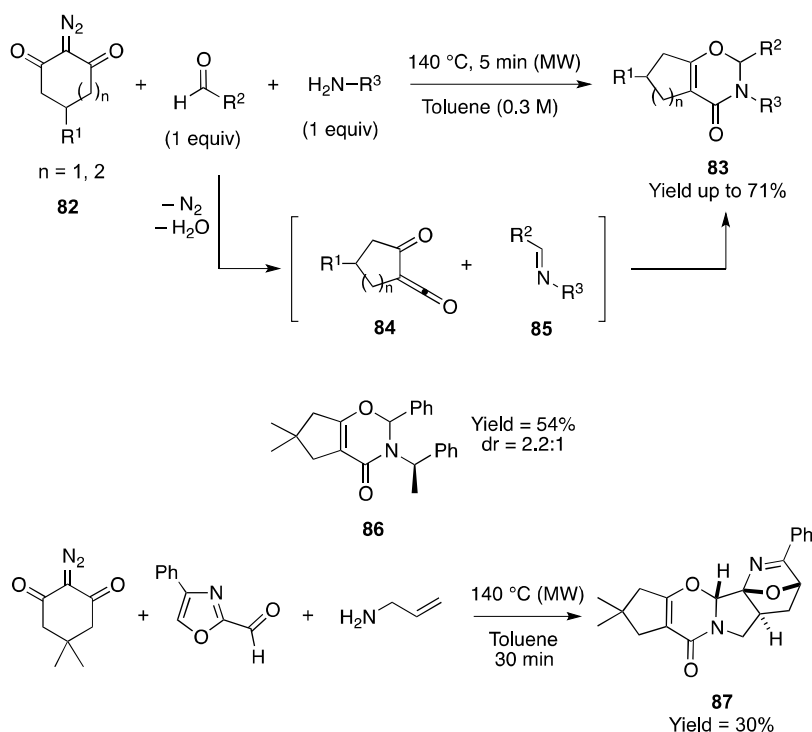

Scheme 27

More recently, we disclosed that α -oxo-ketenes can actually be excellent dienophiles in aza-Diels–Alder cycloadditions, and we have developed a highly diastereoselective three-component synthesis of α -spiro- δ -lactams **88** following an imination-Wolff rearrangement-aza-Diels–Alder domino sequence (Scheme 28).⁶⁴

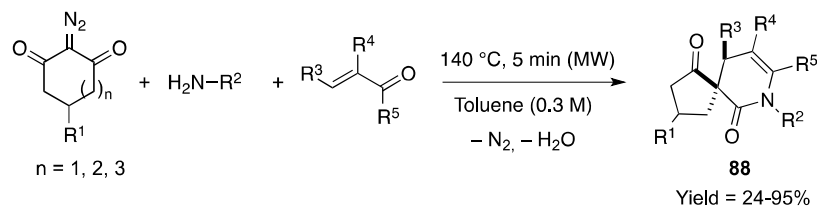

Scheme 28

3. Enantioselective multicomponent reactions

An interesting organocatalytic enantioselective MCR⁶⁵ is the asymmetric 1,3-dipolar cycloaddition of aldehydes, diethyl α -aminomalonate (**89**) and nitroalkenes for the synthesis of highly substituted pyrrolidines **92** (Scheme 29).⁶⁶ The reaction involves the *in situ* formation of azomethine ylides **91**, between the aminomalonate **89** and the aldehyde, that reacts with the nitroalkene **90**, which is activated by the thiourea moiety of catalyst **91**, in a 1,3-dipolar cycloaddition with complete *endo* selectivity (>99:1). One limitation is the use of aliphatic aldehydes, which do not participate in this reaction.

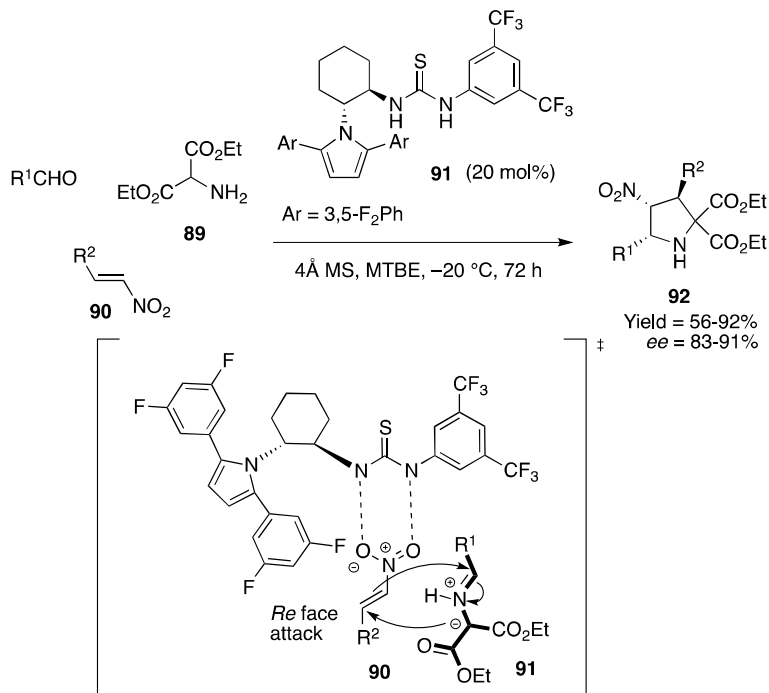

Scheme 29

A similar very efficient asymmetric three-component 1,3-dipolar cycloaddition has been developed by Gong for the access to spiro[pyrrolidin-3,3'-oxindole] derivatives **97** which constitutes the first enantioselective approach to this privileged heterocycle (Scheme 30).⁶⁷ The reaction involved methyleneindolinones **93**, aldehydes and aminomalonates **94** as starting components and employed the chiral phosphoric acid **95** as the organocatalyst. In the proposed transition state, the hydroxyl proton and the phosphoryl oxygen of the

chiral phosphoric acid **95** would form double hydrogen bonding interactions with the methyleneindolinones **93** and the azomethine ylide dipole **96**, respectively.

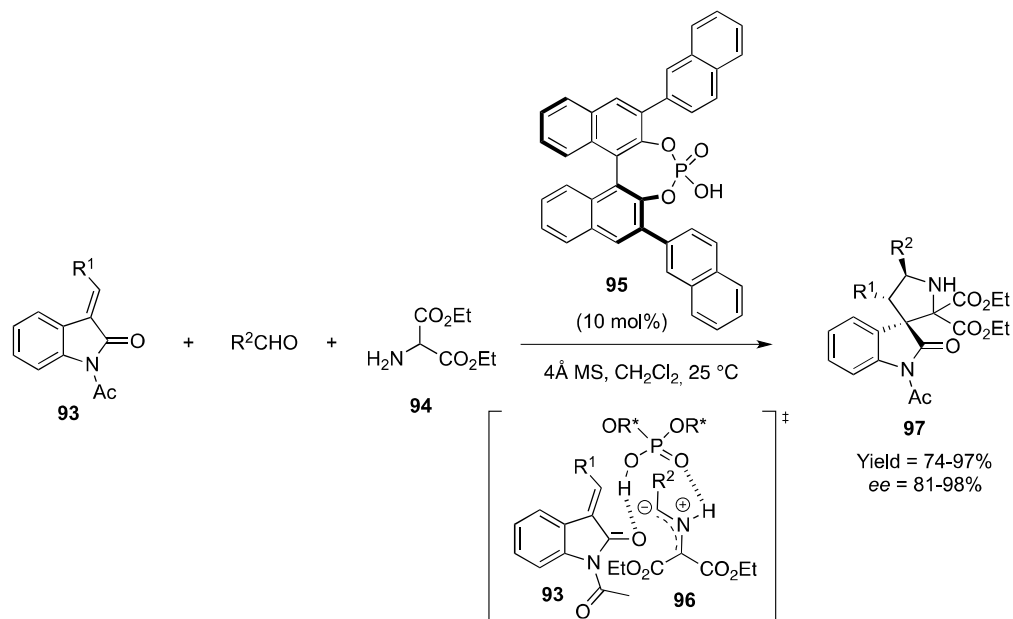

Spirooxindole heterocycles have also been synthesized by Yuan and co-workers in an enantioselective manner using a domino Knoevenagel-Michael-cyclization sequence using cupreine (**101**) as the organocatalyst (Scheme 31).⁶⁸ Here again, optically active spiro[4*H*-pyran-3,3'-oxindole] heterocycles **102** were obtained for the first time in very good yield and selectivities from easy accessible isatin derivatives **98**, malononitrile (**99**) and β -diketones or β -ketoesters **100**.

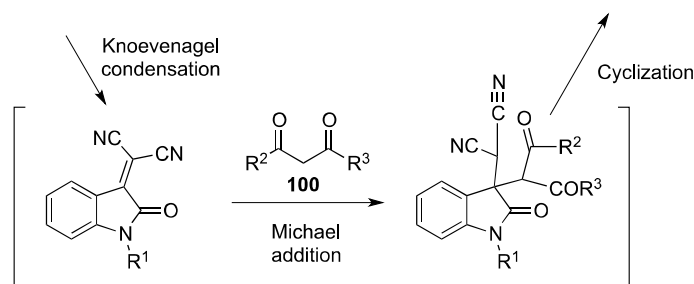
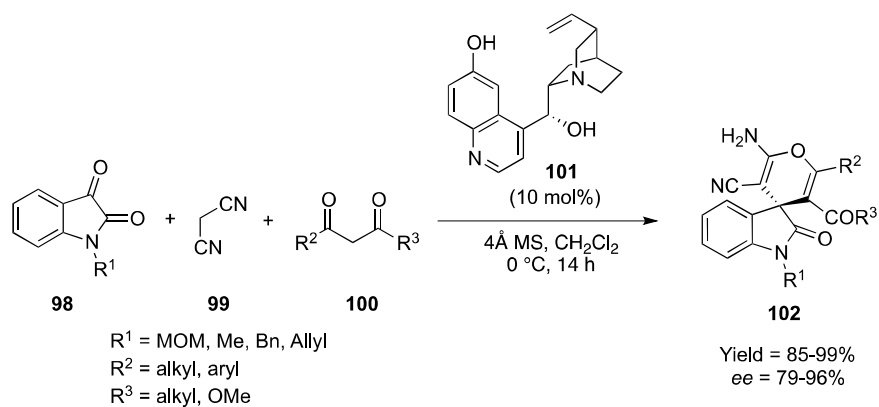

Chen and co-workers have reported an impressive asymmetric quadruple domino reaction to fused carbocycles **105** incorporating a spirooxindole moiety (Scheme 32).⁶⁹ This three-component reaction between (*E*)-4-(1-methyl-2-oxindolin-3-ylidene)-3-oxabutanoates (**103**) and two distinct molecules of α,β -unsaturated aldehydes involves a domino Michael-Michael-Michael-aldol process under successive iminium-enamine-iminium-enamine catalysis with the TMS-prolinol derivative **104**. Six contiguous stereogenic centres were created and controlled during this reaction.

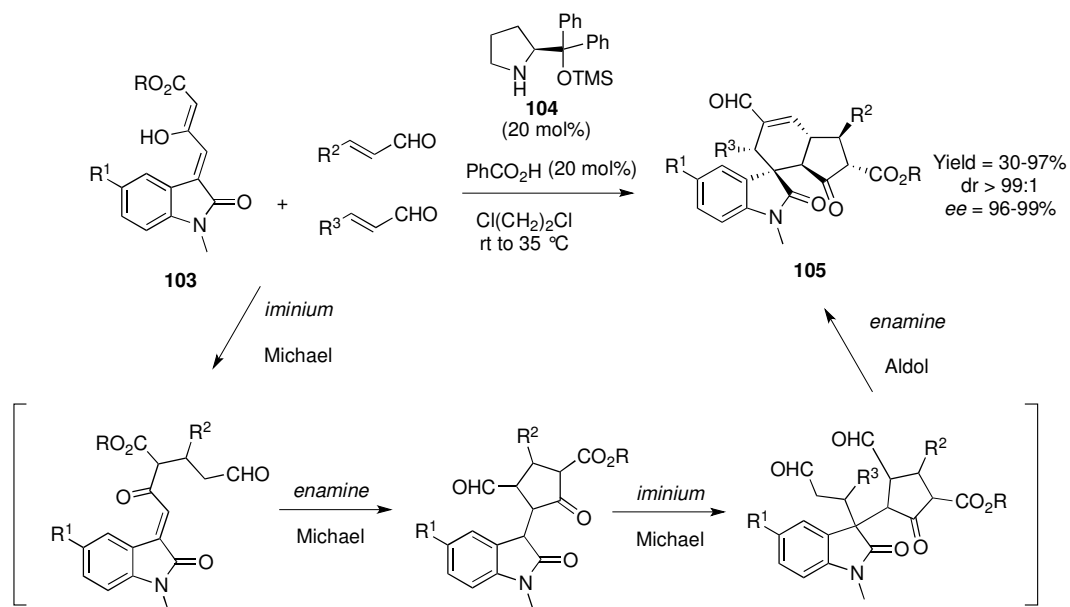

Very recently, a related pseudo three-component Michael-Michael-aldol sequence involving pyrazol-2-ones **106** as masked synthetic equivalent of 1,3-dicarbonyl was proposed by Rios and collaborators for the highly stereoselective synthesis of spiropyrazolones **107**.⁷⁰ This organocatalytic transformation is promoted by diphenylprolinol silyl ether **104** in presence of benzoic acid and two equivalents of an α,β -unsaturated aldehyde (Scheme 33).

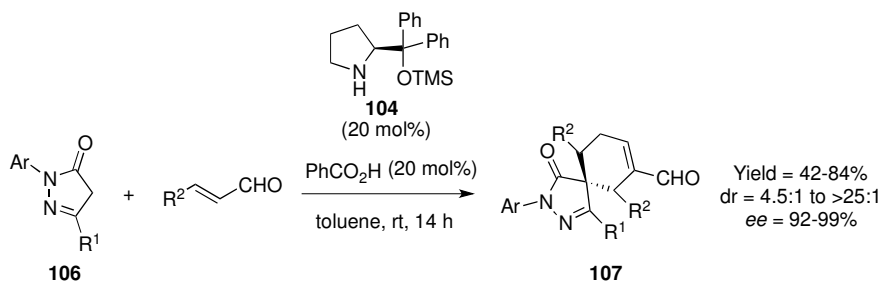

Preliminary results in the catalytic enantioselective Biginelli reaction were reported in 2003, on the use of catalytic amounts of CeCl_3 in combination with a ligand derived from (*R*)- α -methylbenzylamine.⁷¹ Thus, condensation of benzaldehyde with urea and methylacetoacetate in the presence of this catalytic system resulted in the formation of the desired 3,4-dihydropyrimidin-2-(1*H*)-one (DHPM) with 24% ee. More significantly, in 2005, the first highly enantioselective Biginelli reaction using recyclable ytterbium triflate coordinated with a novel chiral hexadentate ligand **108** bearing tertiary amine, phenol and pyridine

functional groups was reported (Scheme 34).⁷² The desired heterocycles **109** were obtained in high yields with enantiomeric excesses up to 99%.

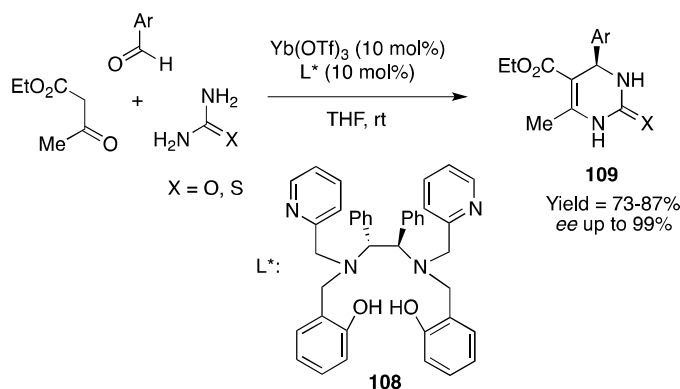

Scheme 34

The crucial advance was the discovery of the organocatalyzed enantioselective version of the Biginelli reaction in 2006.^{73,74} An enantiomerically pure chiral phosphoric acid **110** was used as a catalyst which allowed access to DHPMs **111** with very good enantioselectivities (up to 97% ee, Scheme 35). Enantioselective addition of β -ketoester to chiral *N*-acyliminium phosphate ion pair **112** generates the intermediate **113**, which, after condensation, gives the optically active DHPM **111**. More recently, the same group has shown that the size of the 3,3'-substituents of the phosphoric acid catalyst has a considerable impact on the control of the stereochemistry and a fine tuning of these substituents allowed the synthesis of both enantiomers of the same DHPM.⁷⁵

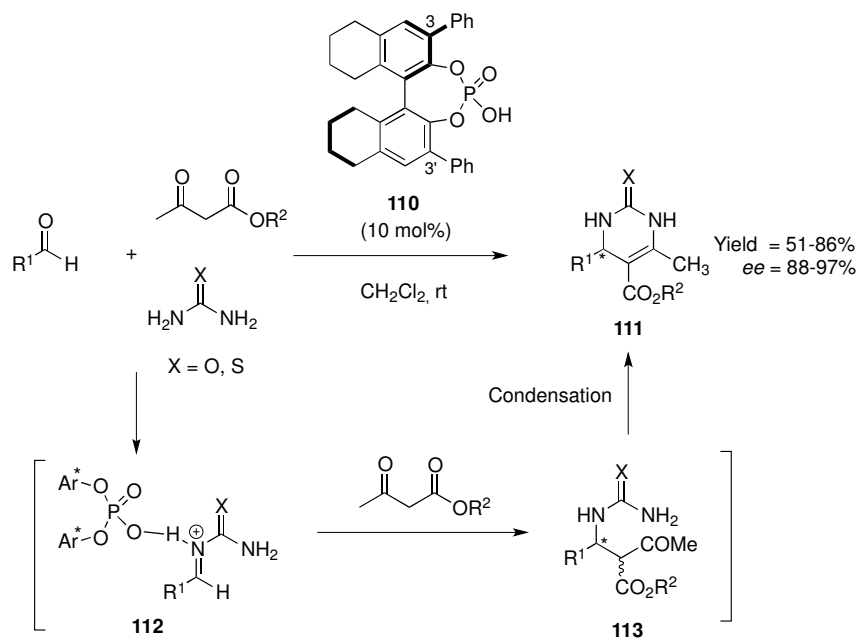

Scheme 35

This same chiral phosphoric acid organocatalyst **114** was recently employed in the Biginelli reaction as a key-step for the enantioselective synthesis of SNAP-7941, a potent melanin concentrating hormone receptor antagonist (Scheme 36).⁷⁶ Organocatalytic enantioselective Biginelli reactions have also been

studied using a proline-type organocatalyst in combination with an achiral Brønsted acid co-catalyst⁷⁷ and also with cinchona alkaloids as organocatalysts.⁷⁸

Xu and co-workers demonstrated a cooperative effect between the Lewis acid NbCl₅ and a quinine-derived organocatalyst for an enantioselective Biginelli reaction affording DHPMs in good yield and moderate enantioselectivities.⁷⁹

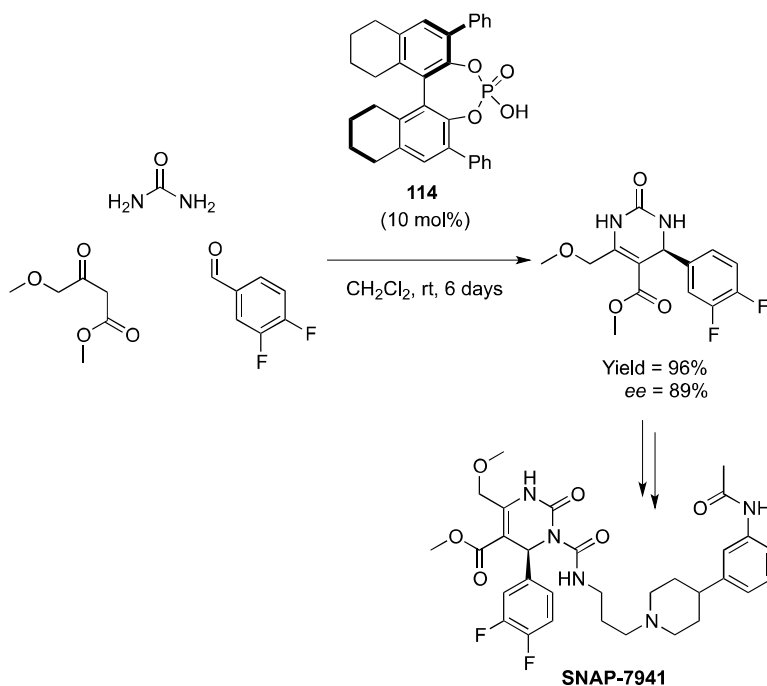

Scheme 36

Alternatively a carbohydrate-based bifunctional primary amine-thiourea catalyst **115** was developed for the enantioselective Biginelli reaction (Scheme 37).⁸⁰ In this case, both the hydrogen-bonding interactions and the enamine activation of the β -ketoester are invoked to explain the high stereochemical control in the dihydropyrimidine products **116**.

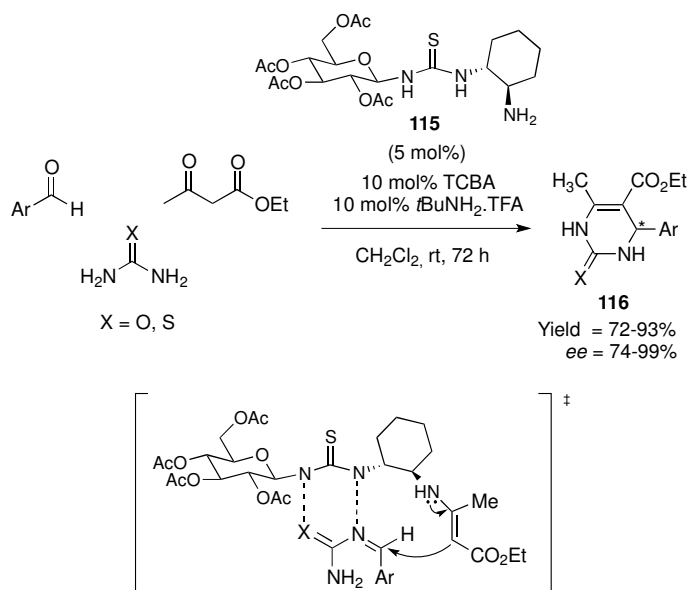

Scheme 37

The use of a Brønsted acid such as trichlorobenzoic acid (TCBA) and a primary amine salt as co-catalysts is required in order to reach high enantioselectivities.

This next example of organocatalyzed MCR is an enantioselective version of the modified Hantzsch reaction that we have exposed previously. Here, the three components, a primary amine, an α,β -unsaturated aldehyde and an α,β -ketoester are mixed simultaneously in the presence of an organocatalyst (phosphoric acid **114**) for the synthesis of enantiomerically enriched dihydropyridines (DHP) **117** (ee up to 98%, Scheme 38).⁸¹ The mechanism involves the formation of an α,β -unsaturated imine **118** resulting from the condensation between the amine and the aldehyde. It is activated through hydrogen bonding interactions with the hydroxyl group of the organocatalyst and undergoes nucleophilic addition of the β -ketoester. Cyclization followed by dehydration allows the formation of the desired DHP **117**.

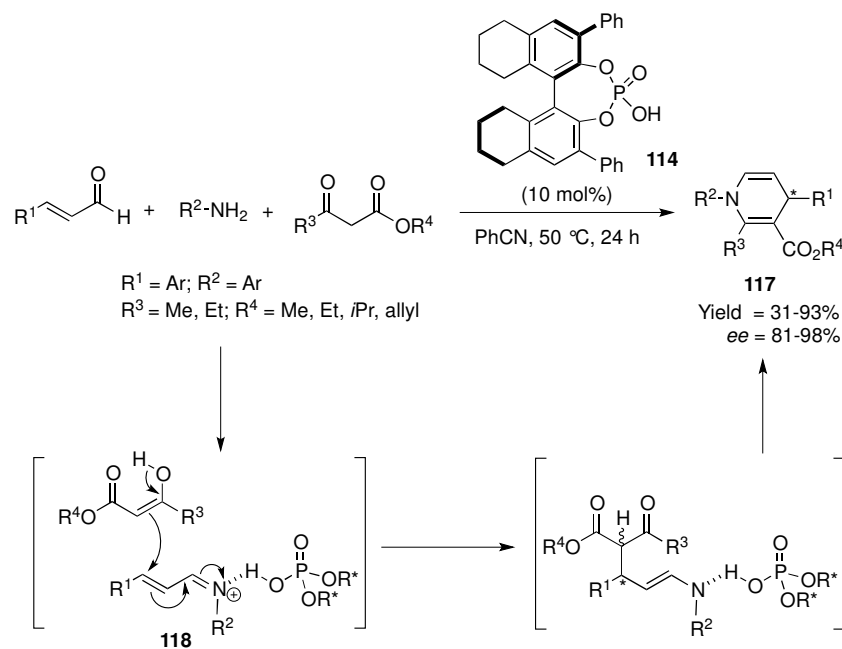

Scheme 38

A similar sequence was developed contemporaneously also for the synthesis of enantioenriched dihydropyridines.⁸²

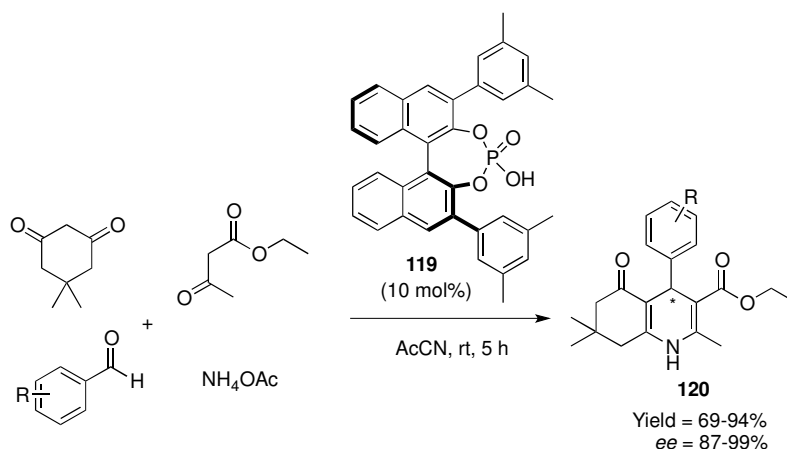

Scheme 39

However, this reaction is not considered as a MCR since the addition of the third reagent (primary amine) is not simultaneous but takes place after the formation of the Michael adduct (between a β -ketoester or a β -diketone and an α,β -unsaturated aldehyde). Thus, in this specific case, the descriptor of *consecutive reaction* is more appropriate.²

More recently, an enantioselective four-component reaction has been developed to prepare bicyclic DHPs **120** (Scheme 39).⁸³ As before, the use of a chiral phosphoric acid **119** led to the formation of the products with high enantioselectivities.

4. Conclusion

This compilation of selected examples from the recent literature clearly shows that 1,3-dicarbonyl compounds are extremely valuable substrates in stereoselective multicomponent reactions.

Of course the use of chiral substrates/auxiliaries allows the control of chirality in these reactions, but the most significant contributions are found in enantioselective approaches essentially based on organocatalysis. On a practical point of view, the beauty and effectiveness of these reactions are reinforced by the simplicity of the protocols involved in regards of the rapid increase of molecular complexity and functional diversity in the products.

These reactions have already found many applications in the field of combinatorial and medicinal chemistry. The main challenge is now to develop new MCRs allowing straightforward applications in total synthesis. The use of several distinct activation modes in the same sequence is expected to further increase the scope and the eco-compatible character of these new methodologies in organic synthesis.

Acknowledgements

We thank all the students from our research group who have contributed to the several successful studies reported in this review. Financial support from Centre National de la Recherche Scientifique (CNRS) and Aix-Marseille Université is gratefully acknowledged.

References

1. Step economy: (a) Wender, P. A.; Verma, V. A.; Paxton, T. J.; Pillow, T. H. *Acc. Chem. Res.* **2008**, *41*, 40–49, and references therein. Atom economy: (b) Trost, B. M. *Acc. Chem. Res.* **2002**, *35*, 695–705, and references therein. Redox economy: (c) Burns, N. Z.; Baran, P. S.; Hoffmann, R. W. *Angew. Chem. Int. Ed.* **2009**, *48*, 2854–2867. For a discussion, using cases-study from complex molecules total syntheses, see: (d) Newhouse, T.; Baran, P. S.; Hoffmann, R. W. *Chem. Soc. Rev.* **2009**, *38*, 3010–3021. (e) Vaxelaire, C.; Winter, P.; Christamann, M.; *Angew. Chem. Int. Ed.* **2011**, *50*, 3605–3607.
2. Coquerel, Y.; Boddaert, T.; Pisset, M.; Mailhol, D.; Rodriguez, J. In *Ideas in Chemistry and Molecular Sciences: Advances in Synthetic Chemistry*; Pignataro, B., Ed.; Wiley-VCH: Weinheim, Germany, 2010; Chap. 9, pp. 187–202, and references therein.
3. Sheldon, R. A.; Arends, I.; Hanefeld, U. *Green Chemistry and Catalysis*; Wiley-VCH: Weinheim, Germany, 2007, and references therein.
4. *Multicomponent Reactions*; Zhu, J.; Bienaymé, H., Eds.; Wiley-VCH: Weinheim, Germany, 2005.
5. (a) Wender, P. A.; Handy, S. T.; Wright, D. L. *Chem. Ind.* **1997**, 765–769. (b) Gaich, T.; Baran, P. S. *J. Org. Chem.* 2010, *75*, 4657–4673.
6. (a) Colombo, M.; Peretto, I. *Drug Discov. Today* **2008**, *13*, 677–684. (b) Ulaczyk-Lesanko, A.; Hall, D. G. *Curr. Opin. Chem. Biol.* **2005**, 266–276. (c) Hulme, C.; Gore, V. *Curr. Med. Chem.* **2003**, *10*, 51–80. (d) Orru, R. V. A.; de Grief, M. *Synthesis* **2003**, 1471–1499. (e) Gelens, E.; De Kanter, F. J. J.; Schmitz, R. F.; Sliedregt, L. A. J. M.; Van Steen, B. J.; Kruse, C. G.; Leurs, M.; Groen, M. B.; Orru,

- R. V. A. *Mol. Diversity* **2006**, *10*, 17–22. (f) Isambert, N.; Lavilla, R. *Chem. Eur. J.* **2008**, *14*, 8444–8454.
7. (a) Nicolaou, K. C.; Chen, J. S. *Chem. Soc. Rev.* **2009**, *38*, 2993–3009. (b) Touré, B. B.; Hall, D. G. *Chem. Rev.* **2009**, *109*, 4439–4486.
 8. Hantzsch, A. *Justus Liebigs Ann. Chem.* **1882**, *215*, 1–82.
 9. For contributions in the field, see: (a) Simon, C.; Constantieux, T.; Rodriguez, J. *Eur. J. Org. Chem.* **2004**, 4957–4980. (b) Bonne, D.; Coquerel, Y.; Constantieux, T.; Rodriguez, J. *Tetrahedron: Asymmetry* **2010**, *21*, 1085–1109.
 10. For early reviews on asymmetric MCRs, see: (a) Ramon, D. J.; Yus, M. *Angew. Chem. Int. Ed.* **2005**, *44*, 1602–1634. (b) Guillena, G.; Ramón, D. J.; Yus, M. *Tetrahedron: Asymmetry* **2007**, *18*, 693–700. (c) Enders, D.; Grondal, C.; Hüttl, M. R. M. *Angew. Chem. Int. Ed.* **2007**, *46*, 1570–1581. (d) Grondal, C.; Jeanty, M.; Enders, D. *Nature Chem.* **2010**, *2*, 167–178.
 11. For pioneer works, see: Rose, U.; Draeger, M. *J. Med. Chem.* **1992**, *35*, 2238–2243.
 12. (a) Dondoni, A.; Massi, A. *Acc. Chem. Res.* **2006**, *39*, 451–463. (b) Dondoni, A.; Massi, A.; Aldhoun, M. *J. Org. Chem.* **2007**, *72*, 7677–7687.
 13. Ducatti, D. R. B.; Massi, A.; Nosedà, M. D.; Duarte, M. E. R.; Dondoni, A. *Org. Biomol. Chem.* **2009**, *7*, 1980–1986.
 14. Chebanov, V. A.; Saraev, V. E.; Desenko, S. M.; Chermenko, V. N.; Knyazeva, I. V.; Groth, U.; Glasnov, T. N.; Kappe, C. O. *J. Org. Chem.* **2008**, *73*, 5110–5118.
 15. Shaabani, A.; Rahmati, A.; Rezayan, A. H.; Darvishi, M.; Badri, Z.; Sarvari, A. *QSAR Comb. Sci.* **2007**, *26*, 973–979.
 16. Biginelli, P. *Gazz. Chim. Ital.* **1893**, *23*, 360–413.
 17. For a recent review, see: Wan, J.-P.; Liu, Y. *Synthesis* **2010**, 3943–3953.
 18. (a) Kappe, C. O. *Eur. J. Med. Chem.* **2000**, *35*, 1043–1052. (b) Kappe, C. O. *QSAR Comb. Sci.* **2003**, *22*, 630–645.
 19. (a) Atwal, K. S.; Swanson, B. N.; Unger, S. E.; Floyd, D. M.; Moreland, S.; Hedberg, A.; O'Reilly, B. C. *J. Med. Chem.* **1991**, *34*, 806–811. (b) Maliga, Z.; Kapoor, T. M.; Mitchison, T. J. *Chem. Biol.* **2002**, *9*, 989–996. (c) Debonis, S.; Simorre, J. P.; Crevel, I.; Lebeau, L.; Skoufias, D. A.; Blangy, A.; Ebel, C.; Gans, P.; Cross, R.; Hackney, D. D.; Wade, R. H.; Kozielski, F. *Biochemistry* **2003**, *42*, 338–349.
 20. Gong, L.-Z.; Chen, X.-H.; Xu, X.-Y. *Chem. Eur. J.* **2007**, *13*, 8920–8926.
 21. For recent reviews on the asymmetric Mannich reaction, see: (a) Córdova, A. *Acc. Chem. Res.* **2004**, *37*, 102–112. (b) Verkade, J. M. M.; van Hemert, L. J. C.; Quaedflieg, P. J. L. M.; Rutjes, F. P. J. T. *Chem. Soc. Rev.* **2008**, *37*, 29–41. (c) Arrayás, R. G.; Carretero, J. C. *Chem. Soc. Rev.* **2009**, *38*, 1940–1948.
 22. Mukhopadhyay, M.; Bhatia, B.; Iqbal, J. *Tetrahedron Lett.* **1997**, *38*, 1083–1086.
 23. (a) Pandey, G.; Singh, R. P.; Garg, A.; Singh, V. K. *Tetrahedron Lett.* **2005**, *46*, 2137–2140. (b) Bhat, R. P.; Raje, V. P.; Alexander, V. M.; Patil, S. B.; Samant, S. D. *Tetrahedron Lett.* **2005**, *46*, 4801–4803. (c) Das, B.; Reddy, K. R.; Ramu, R.; Thirupathi, P.; Ravikanth, B. *Synlett* **2006**, 1756–1758. (d) Khan, A. T.; Choudhury, L. H.; Parvin, T.; Ali, M. A. *Tetrahedron Lett.* **2006**, *47*, 8137–8141. (e) Khan, A. T.; Parvin, T.; Choudhury, L. H. *Tetrahedron* **2007**, *63*, 5593–5601. (f) Ghosh, R.; Maiti, S.; Ghosh, S.; Mukherjee, A. K. *Synthesis* **2007**, 190–196. (g) Mirjafary, Z.; Saeidian, H.; Sadeghi, A.; Moghaddam, F. M. *Catal. Commun.* **2008**, *9*, 299–306. (h) Das, B.; Srilatha, M.; Veeranjanyulu, B.; Rao, B. R. *Synthesis* **2010**, 803–806.
 24. Barluenga, J.; Viado, A. L.; Aguilar, E.; Fustero, S. *J. Org. Chem.* **1993**, *58*, 5972–5975.
 25. Rao, I. N.; Prabhakaran, E. N.; Das, S. K.; Iqbal, J. *J. Org. Chem.* **2003**, *68*, 4079–4082.
 26. Shinu, V. S.; Sheeja, B.; Purushothaman, E.; Bahulayan, D. *Tetrahedron Lett.* **2009**, *50*, 4838–4843.
 27. Mao, H.; Wan, J.; Pan, Y. *Tetrahedron* **2009**, *65*, 1026–1032.
 28. Fujioka, H.; Murai, K.; Kubo, O.; Ohba, Y.; Kita, Y. *Org. Lett.* **2007**, *9*, 1687–1690.
 29. Sotoca, E.; Allais, C.; Constantieux, T.; Rodriguez, J. *Org. Biomol. Chem.* **2009**, *7*, 1911–1920.
 30. Sotoca, E.; Constantieux, T.; Rodriguez, J. *Synlett* **2008**, 1313–1316.
 31. Murai, K.; Nakatani, R.; Kita, Y.; Fujioka, H. *Tetrahedron* **2008**, *64*, 11034–11040.
 32. Khan, A.T.; Parvin, T.; Choudhury, L.H. *J. Org. Chem.* **2008**, *73*, 8398–8402.

33. Khan, A.T.; Lal, M.; Md. Khan, M. *Tetrahedron Lett.* **2010**, *51*, 4419–4424.
34. List, B. *Angew. Chem. Int. Ed.* **2010**, *49*, 1730–1734.
35. (a) Tietze, L. F.; Beifuss, U. *Angew. Chem. Int. Ed.* **1993**, *32*, 131–163. (b) Tietze, L. F. *Chem. Rev.* **1996**, *96*, 115–136. (c) Tietze, L. F.; Modi, A. *Med. Res. Rev.* **2000**, *20*, 304–322.
36. Tietze, L. F.; Rackelmann, N.; Müller, I. *Chem. Eur. J.* **2004**, *10*, 2722–2731.
37. Jimenez-Alonso, S.; Chavez, H.; Estevez-Braun, A.; Ravelo, A. G.; Feresin, G.; Tapia, A. *Tetrahedron* **2008**, *64*, 8938–8942.
38. Palasz, A. *Synthesis* **2010**, 4021–4032.
39. Radi, M.; Bernardo, V.; Bechi, B.; Castagnolo, D.; Pagano, M.; Botta, M. *Tetrahedron Lett.* **2009**, *50*, 6572–6575.
40. Ma, N.; Jiang, B.; Zhang, G.; Tu, S.-J.; Wever, W.; Li, G. *Green Chem.* **2010**, *12*, 1357–136.
41. Li, M.; Yang, W.-L.; Wen, L.-R.; Li, F.-Q. *Eur. J. Org. Chem.* **2008**, 2751–2758.
42. Ghandi, M.; Taheri, A.; Abbasi, A. *Tetrahedron* **2010**, *66*, 6744–6748.
43. Zhao, K.; Zhu, S.-L.; Shi, D.-Q.; Xu, X.-P.; Ji, S.-J. *Synthesis* **2010**, 1793–1803.
44. Song, S.; Song, L.; Dai, B.; Yi, H.; Jin G.; Zhu S.; Shao M. *Tetrahedron* **2008**, *64*, 5728–5735.
45. (a) Vasuki, G.; Kumaravel, K. *Tetrahedron Lett.* **2008**, *49*, 5636–5638. (b) Nagarajan, A. S.; Reddy, B. S. R. *Synlett* **2009**, 2002–2004. (c) Litvinov, Y. M.; Shestopalov, A. A.; Rodinovskaya, L. A.; Shestopalov, A. M. *J. Comb. Chem.* **2009**, *11*, 914–919.
46. Han, Y.; Hou, H.; Yao, R.; Fu, Q.; Yan, C.-G. *Synthesis* **2010**, 4061–4067.
47. Sun, J.; Wu, Q.; Xia, E.-Y.; Yan, C.-G. *Synthesis* **2010**, 3987–3992.
48. Liu, J.; Lin, S.; Ding, H.; Wei, Y.; Liang, F. *Tetrahedron Lett.* **2010**, *51*, 6349–6352.
49. Adib, M.; Ansari, S.; Bijanzadeh, H. R. *Synlett* **2011**, 619–622.
50. For a recent review, see: Liéby-Muller, F.; Simon, C.; Constantieux, T.; Rodriguez, J. *QSAR Comb. Sci* **2006**, *25*, 432–438.
51. For chapter of this topic, see: Sanchez Duque, M.; Allais, C.; Isambert, N.; Constantieux, T.; Rodriguez, J. *Top. Heterocycl. Chem.* **2010**, *23*, 227–277.
52. Shibuya, M.; Jaisli, F.; Eschenmoser, A. *Angew. Chem., Int. Ed. Engl.* **1979**, *18*, 636–637.
53. Simon, C.; Peyronel, J.-F.; Rodriguez, J. *Org. Lett.* **2001**, *3*, 2145–2148.
54. Noël, R.; Fargeau-Bellassoued, M.-C.; Vanucci-Bacqué, C.; Lhommet, G. *Synthesis* **2008**, 1948–1954.
55. Liéby-Muller, F.; Constantieux, T.; Rodriguez, J. *Synlett* **2007**, 1323–1325.
56. Liéby-Muller, F.; Constantieux, T.; Rodriguez, J. *J. Am. Chem. Soc.* **2005**, *127*, 17176–17177.
57. Sridharan, V.; Maiti, S.; Menendez, J. C. *Chem. Eur. J.* **2009**, *15*, 4565–4572.
58. Coquerel, Y.; Filippini, M.-H.; Bensa, D.; Rodriguez, J. *Chem. Eur. J.* **2008**, *14*, 3078–3092.
59. Coquerel, Y.; Bensa, D.; Doutheau, A.; Rodriguez, J. *Org. Lett.* **2006**, *8*, 4819–4822.
60. (a) Alizadeh, A.; Rezvani, A.; Zhu, L. G. *Tetrahedron* **2008**, *64*, 351–355. (b) Alizadeh, A.; Rostamnia, S. *Synthesis* **2010**, 4057–4060.
61. Giorgi, G.; Miranda, S.; Lopez-Alvarado, P.; Avendano, C.; Rodriguez, J.; Menendez, J. C. *Org. Lett.* **2005**, *7*, 2197–2200.
62. Presset, M.; Coquerel, Y.; Rodriguez, J. *J. Org. Chem.* **2009**, *74*, 415–418.
63. Presset, M.; Coquerel, Y.; Rodriguez, J. *Org. Lett.* **2009**, *11*, 5706–5709.
64. Presset, M.; Coquerel, Y.; Rodriguez, J. *Org. Lett.* **2010**, *12*, 4212–4215.
65. For reviews on organocatalytic domino reactions, see: (a) Enders, D.; Grondal, C.; Hüttl, M. R. M. *Angew. Chem. Int. Ed.* **2007**, *46*, 1570–1561. (b) Yu, X.; Wang, W. *Org. Biomol. Chem.* **2008**, *6*, 2037–2046. See also ref 10d.
66. Liu, Y.-K.; Liu, H.; Du, W.; Yue, L.; Chen, Y.-C. *Chem. Eur. J.* **2008**, *14*, 9873–9877.
67. Chen, X.-H.; Wei, Q.; Luo, S.-W.; Xiao, H.; Gong, L.-Z. *J. Am. Chem. Soc.* **2009**, *131*, 13819–13825.
68. Chen, W.-B.; Wu, Z.-J.; Pei, Q.-L.; Cun, L.-F.; Zhang, X.-M.; Yuan, W.-C. *Org. Lett.* **2010**, *12*, 3132–3135.
69. Jiang, K.; Jia, Z.-J.; Yin, X.; Wu, L.; Chen, Y.-C. *Org. Lett.* **2010**, *12*, 2766.
70. Alba, A.-N. R.; Zea, A.; Valero, G.; Calbet, T.; Font-Bardía, M.; Mazzanti, A.; Moyano, A.; Rios R. *Eur. J. Org. Chem.* **2011**, 1318–1325.
71. Muñoz-Muñoz, O.; Juaristi, E. *Arkivoc* **2003**, *xi*, 16–26.
72. Huang, Y. J.; Yang, F. Y.; Zhu, C. J. *J. Am. Chem. Soc.* **2005**, *127*, 16386–16387.

73. Chen, X.-H.; Xu, X.-Y.; Liu, H.; Cun, L.-F.; Gong, L.-Z. *J. Am. Chem. Soc.* **2006**, *128*, 14802–14803.
74. For a review, see: Gong, L.-Z.; Chen, X. H.; Xu X.-Y. *Chem. Eur. J.* **2007**, *13*, 8920–8926.
75. Li, N.; Chen, X.-H.; Song, J.; Luo, S.-W.; Fan, W.; Gong, L.-Z. *J. Am. Chem. Soc.* **2009**, *131*, 15301–15310.
76. Goss, J. M.; Schaus, S. E. *J. Org. Chem.* **2008**, *73*, 7651–7656.
77. Xin, J.; Chang, L.; Hou, Z.; Shang, D.; Liu, X.; Feng, X. *Chem. Eur. J.* **2008**, *14*, 3177–3181.
78. Ding, D.; Zhao, G.-G. *Eur. J. Org. Chem.* **2010**, 3802–3805.
79. Cai, Y.-F.; Yang, H.-M.; Li, L.; Jiang, K.-Z.; Lai, G. Q.; Jiang, J.-X.; Xu, L. W. *Eur. J. Org. Chem.* **2010**, 4986–4990.
80. Wang, Y.; Yang, H.; Yu, J.; Miao, Z.; Chen, R. *Adv. Synth Catal.* **2009**, *351*, 3057–3062.
81. Jiang, J.; Yu, J.; Sun, X.-X.; Rao, Q.-Q.; Gong, L.-Z. *Angew. Chem. Int. Ed.* **2008**, *47*, 2458–2462.
82. Franke, P. T.; Johansen, R. L.; Bertelsen, S.; Jørgensen, K. A. *Chem. Asian J.* **2008**, *3*, 216–224.
83. Evans, C. G.; Gestwicki, J. E. *Org. Lett.* **2009**, *11*, 2957–2959.

CHEMICAL SYNTHESIS OF FIVE-MEMBERED NITROGEN HETEROCYCLES BY REDUCTIVE CYCLIZATION METHODS

Tomás Tejero,* Pedro Merino, Ignacio Delso and David Sadaba

Laboratorio de Síntesis Asimétrica, Instituto de Ciencia de Síntesis Química y Catálisis Homogénea (ISQCH), Universidad de Zaragoza, CSIC, E-50009 Zaragoza, Aragón, Spain (e-mail: ttejero@unizar.es)

Abstract. Reductive cyclization of bifunctional compounds, i.e. γ -nitrocarbonyl and β -cyanocarbonyl derivatives, is one of the most useful and versatile methods for the preparation of five-membered nitrogen heterocycles. The present review focuses on the development of the different reductive methods that can be employed with the above mentioned substrates which, in turn, are easily accessible in enantiomerically pure form. Depending on the reducing systems and starting materials (aldehydes, ketones, esters or other acid derivatives), pyrrolidines, 1-pyrrolines, pyrrolidin-2-ones and cyclic nitrones can be obtained. The review highlights the more representative and recent developments in the area with particular emphasis on aspects related to efficiency and synthetic utility of the obtained compounds.

Contents

1. Introduction
2. Synthesis of five-membered nitrogen heterocycles from γ -nitrocarbonyl compounds
 - 2.1. Hydrogenation
 - 2.1.1. Catalyzed by Raney nickel
 - 2.1.2. Catalyzed by palladium
 - 2.1.3. Catalytic hydrogen transfer reactions
 - 2.2. Reduction with $\text{NiCl}_2/\text{NaBH}_4$
 - 2.3. Reduction with $\text{Zn}/\text{Brønsted}$ acid system
 - 2.4. Reduction with $\text{Fe}/\text{Brønsted}$ acid system
 - 2.5. Reduction with TiCl_3
 - 2.6. Reduction with SnCl_2
3. Synthesis of five-membered nitrogen heterocycles from β -cyanocarbonyl compounds
 - 3.1. Hydrogenation
 - 3.1.1. Catalyzed by Raney nickel
 - 3.1.2. Catalyzed by platinum oxide
 - 3.1.3. Catalyzed by palladium
 - 3.1.4. Catalyzed by rhodium
 - 3.2. Reduction with $\text{NiCl}_2/\text{NaBH}_4$
 - 3.3. Reduction with $\text{CoCl}_2/\text{NaBH}_4$
 - 3.4. Reduction with LiAlH_4
4. Concluding remarks
- Acknowledgments
- References

1. Introduction

The synthesis of pyrrolidine-containing compounds is a demanding goal in view of the fact that the pyrrolidine ring is a key common motif in many biologically active natural products and therapeutic agents.¹⁻⁶ The pyrrolidine ring is found not only in plant kingdom but also in microorganisms, insects and mammals.^{7,8} The importance and structural diversity of pyrrolidines have led to the development of a great variety of synthetic methods for their construction with proper control of functional groups and stereochemistry.⁹⁻¹⁸ Indeed, the synthesis of pyrrolidine derivatives, both in the racemic series and in enantiopure form, constitutes an important target for pharmaceutical research, with many pyrrolidine-containing entities considered as drug candidates in clinical studies. On the other hand, substituted 2-oxopyrrolidines (2-pyrrolidinones) are immediate precursors of important γ -aminoacids, some of which with remarkable biological activity.

Taking into account the ubiquitous presence of pyrrolidines, the development of new, simple and efficient preparative protocols for those structures can be considered a pivotal task in organic synthesis. A large array of synthetic strategies directed to the synthesis of pyrrolidines has been developed to date and are collected in several reviews that have appeared in the last 25 years.¹⁹⁻²⁶ Among the various methods for preparing pyrrolidines, dipolar cycloadditions of azomethine ylides²⁷⁻³² to activated olefins and cyclization of polyfunctional nitrogen compounds^{33,34} represent the most used approaches (Scheme 1).

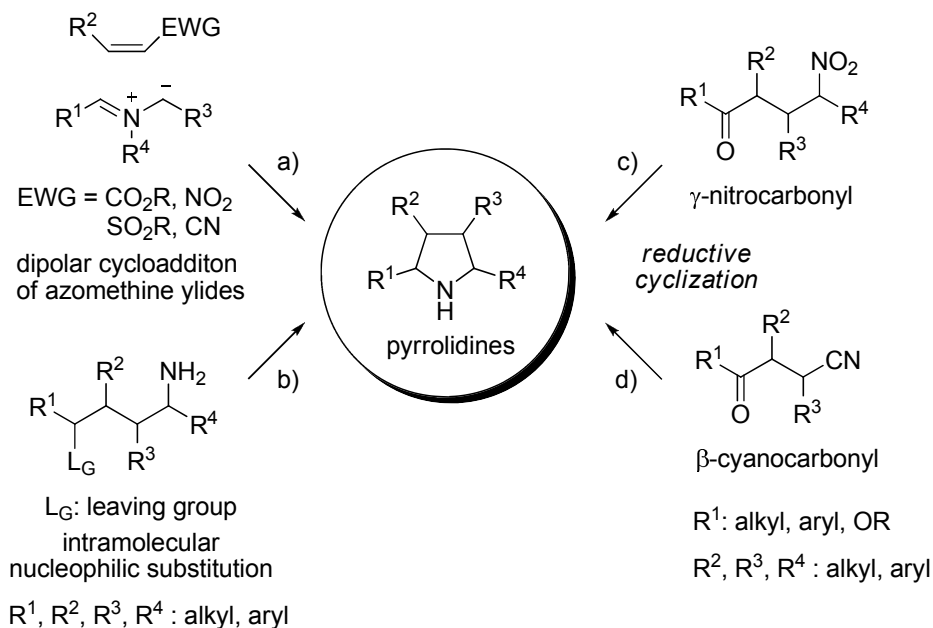

- a) From imines and activated olefins via dipole generation²⁷⁻³²
 b) S_N-type reactions including Mitsunobu reactions³³⁻³⁴
 c) This review, part 2
 d) This review, part 3

Scheme 1

Whereas the former approach is limited to the presence of at least one electron-withdrawing group in the olefin partner, in the latter one it is usually necessary to prepare the substrate by modifying the functionalities initially present in the molecule.^{35,36} On the other hand, it is also possible to carry out the cyclization step in a one-pot procedure by means of reductive processes³⁷ from γ -nitrocarbonyl derivatives,

which are also easily accessible in enantiopure form³⁸ or, alternatively, from β -cyanocarbonyl compounds. This review presents recent and relevant uses of this type of compounds in pyrrolidine synthesis by a direct cyclization based on reductive cyclization processes. Examples that demonstrate the power of this approach will be discussed.

2. Synthesis of five-membered nitrogen-heterocycles from γ -nitrocarbonyl compounds

γ -Nitrocarbonyl compounds can be easily prepared by Michael addition of either enolizable carbonyl compounds or enamines to nitroalkenes or nitroalkanes to α,β -unsaturated carbonyl derivatives. Moreover, the synthesis of such bifunctional organic compounds is also possible in enantiomerically pure form through a variety of methods including organocatalytic processes.³⁸ γ -Nitrocarbonyl derivatives are excellent starting materials for the synthesis of pyrrolidines because the nitro group can be chemoselectively reduced in the presence of the carbonyl group, under a variety of conditions, to furnish amino or hydroxyamino carbonyl intermediates that cyclize *in situ* to the corresponding nitrogen five-membered heterocycles (Scheme 2). Depending on the nature of the carbonyl group (aldehyde, ketone, ester or other acid derivative) and the reducing system, pyrrolidines, 1-pyrrolines and pyrrolidin-2-ones are obtained. When a γ -hydroxyamino carbonyl intermediate is generated in the reduction step, either 1-hydroxypyrrolidin-2-ones (cyclic hydroxamic acids) or cyclic nitrones³⁹ are obtained the former from acid derivatives and the latter from aldehydes and ketones.

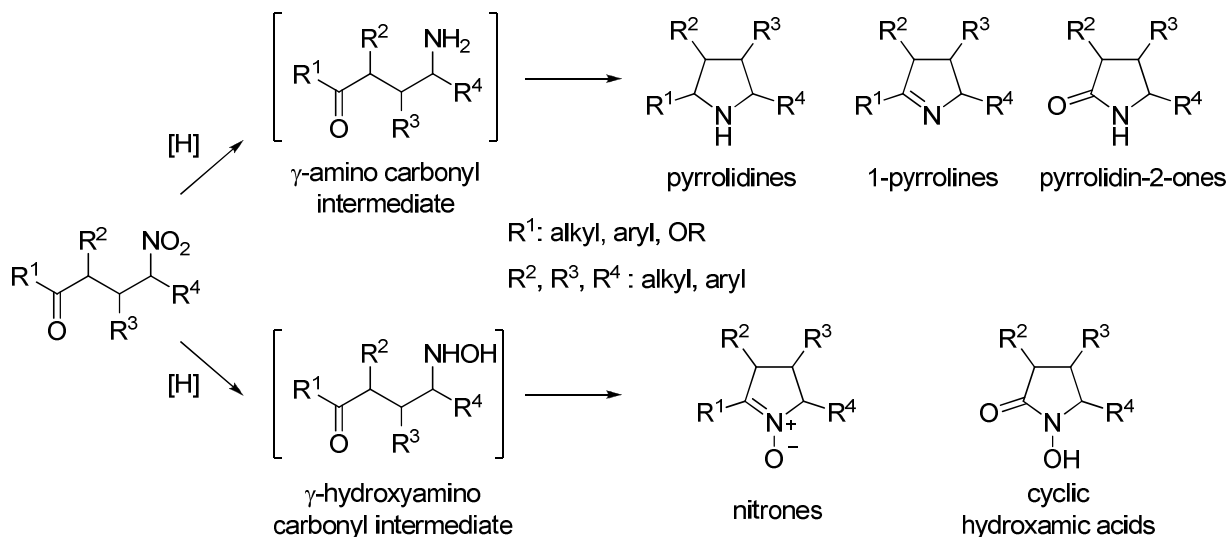

Scheme 2

2.1. Hydrogenation

The hydrogenation of γ -hydroxyamino carbonyl compounds constitutes one of the most used methods for accessing to 2-pyrrolidinones. Depending on the catalytic system employed, pyrrolidines can also be prepared and under particular conditions, cyclic nitrones are the main products of the reaction.

2.1.1. Hydrogenation reactions catalyzed by Raney nickel

Hydrogenation of the methyl γ -nitroester **1**, in the presence of Raney-Ni at 10 bar in ethanol, furnishes the corresponding 4-arylpyrrolidin-2-one **2** in 70% yield (Scheme 3).⁴⁰ When the reaction is carried out with

the ethyl ester, a mixture of compound **2** and the corresponding open-chain γ -aminoester is obtained.⁴¹ Refluxing this mixture in *o*-xylene provides **2** as a single compound, which can be further used in the synthesis of Baclofen, a lipophilic derivative of GABA with important biological activities. The formation of open-chain compounds is also documented when the reaction is carried out in the presence of tartaric acid.⁴² The cyclization reaction of **1** can also be carried out at atmospheric pressure in very good yield.⁴³ Other 4-arylpyrrolidin-2-ones are also accessible under more drastic conditions (6.9 bar, 100 °C).⁴⁴ This reaction has also been employed for preparing a series of 3-substituted,⁴⁵ 3,4-disubstituted⁴⁶ and bicyclic⁴⁷ gababutins, a sort of GABA analogues profiled in *in vivo* models of neuropathic pain and anxiety.⁴⁵⁻⁴⁷

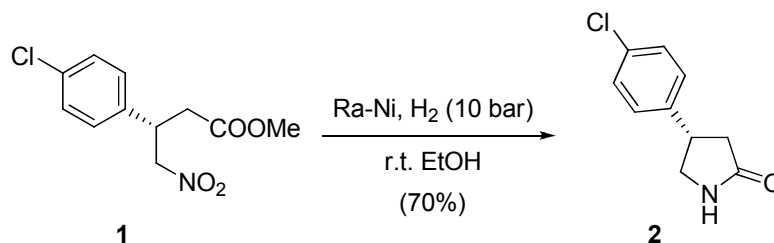

Scheme 3

Similarly, 4-alkylpyrrolidin-2-ones are obtained by treatment of ethyl 3-alkyl- γ -nitroesters with H_2 /Raney-Ni at room temperature and atmospheric pressure in a mixture of EtOH-EtOAc as a solvent. The reaction, which was used for synthesizing (*S*)-Pregabalin⁴⁸ can also be conducted in EtOH as a solvent.⁴⁹ When MeOH is used as solvent, the reaction is performed at 48 psi⁵⁰ and it has been described to be carried out in multigram scale being applied to the synthesis of antibacterial agents.⁵¹ 3,4-Disubstituted pyrrolidin-2-ones **4** have been prepared from the corresponding methyl γ -nitroesters **3** in moderate to good yields (48–76%); further reduction of the formers to pyrrolidines **5** is easily achieved with LiAlH_4 (Scheme 4).⁵²

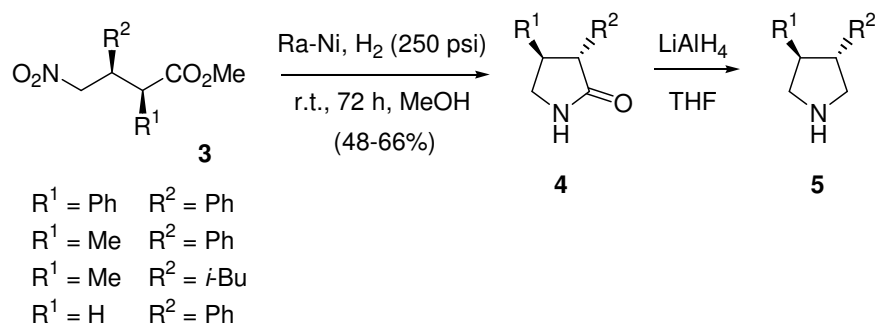

Scheme 4

Better results have been obtained in the reductive cyclization (H_2 /Raney-Ni) of ethyl ester derived from malonic acid **6**, which afforded the expected pyrrolidin-2-ones **7** in good yields (up to 90%) (Scheme 5).⁵³ The reaction is valid for substrates bearing aromatic groups including a pyridine ring⁵⁴ and it can be carried out with isopropyl esters.⁵⁵

The reduction of the nitro group with Raney-Ni with concomitant cyclization to give the corresponding lactam **9** has been used in the synthesis of an intermediate for preparing dysibetaine CPa isolated from *Dysidea herbacea* (Scheme 6).⁵⁶

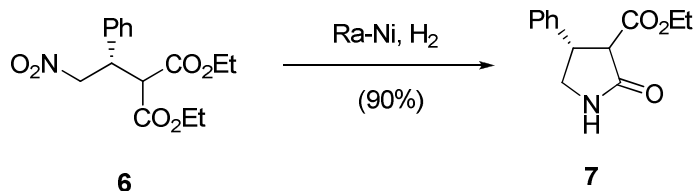

Scheme 5

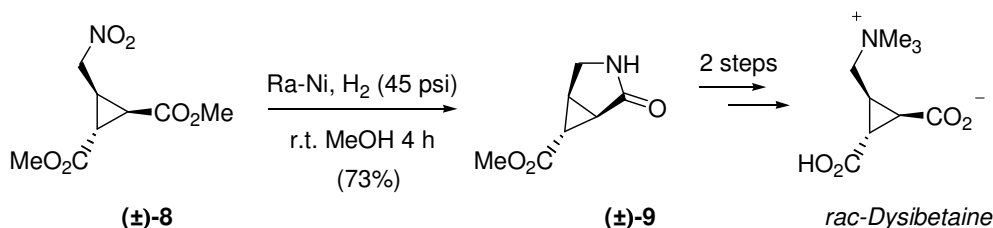

Scheme 6

The same procedure is applicable to the synthesis of a series of 3,4-disubstituted pyrrolidin-2-ones **11**, bearing the indole nucleus in their structure and closely related to staurosporinone, an inhibitor of protein kinase C (Scheme 7).⁵⁷

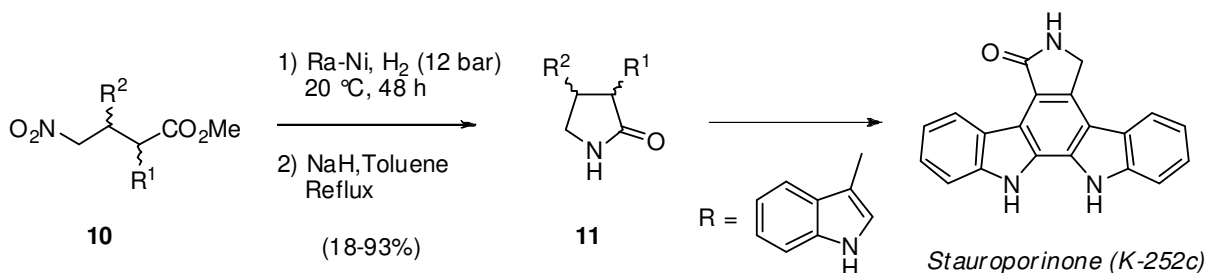

Scheme 7

A concise total synthesis of γ -lycorane is based on the cyclization of the γ -amino ester derived from the γ -nitroester **12** as the key step to give compound **13**. The reaction which is conducted at 80 atm and 55 °C for 24 hours takes place with an excellent chemical yield.⁵⁸ The same reaction conditions can be applied to the synthesis of enantiomerically pure compounds without any loss of optical purity (Scheme 8).⁵⁹

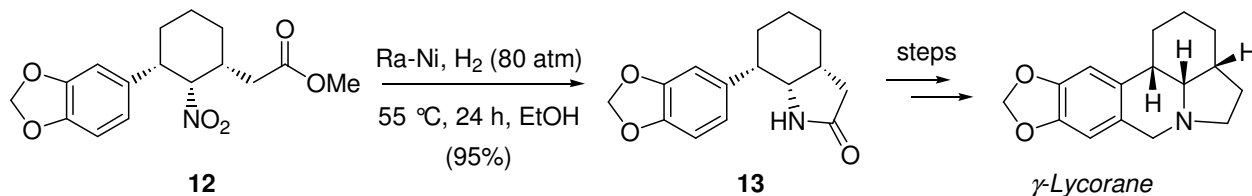

Scheme 8

Mild conditions (1 atm, room temperature) are also applicable to sensitive compounds possessing typical protecting groups like silyl⁶⁰ or benzyl⁶¹ ethers. Other labile groups like *N,O*-acetal such as in **14** are also tolerated under these reductive cyclization conditions even in the presence of the Raney-Ni/H₂PtCl₆

system (Scheme 9). The resulting pyrrolidin-2-one derivative **15** is a precursor of aspartic protease inhibitors.⁶²

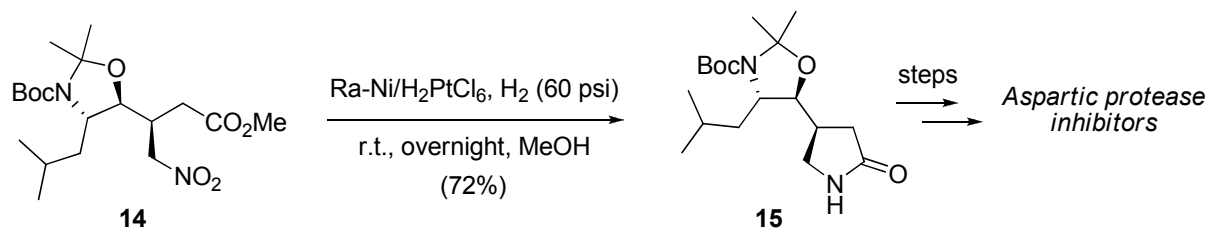

The reduction of optically active 2-(β -nitroalkyl)lactones with Raney-Ni, in the presence of molecular hydrogen, at 30–50 bar, provides enantiopure pyrrolidin-2-ones in good yields.⁶³ The reaction has also been described to occur at 1 atm in a mixture of EtOH/EtOAc as the solvent.⁶⁴ A sequential nitro-reduction/cyclization process on nitrocompounds derived from butane-2,3-diacetal protected glycolic acid derivatives **16** (Scheme 10) furnishes pyrrolidin-2-ones **17** containing different organic functionalities,⁶⁵ thus showing the high compatibility of these reduction conditions with a variety of functional groups.⁶⁶ As an example, the reductive cyclization of compound **18** to give compound **19** is illustrated in Scheme 10.⁶⁷

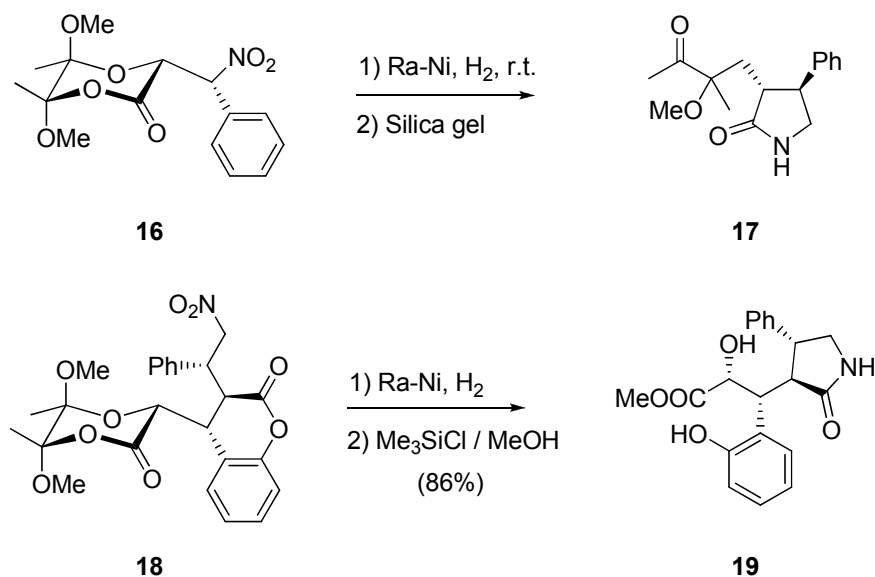

γ -Nitrothioesters **20** form butyrolactams upon treatment with hydrogen in the presence of Raney-Ni. The reaction has been used for the preparation of **21**, an immediate precursor of the antidepressant (–)-Rolipram (Scheme 11).⁶⁸ This compound is also accessible from γ -nitroalkanoylpyrazole **22** under very similar reactions conditions.³¹ Indeed, (–)-Rolipram has been prepared by reductive cyclization of diverse γ -nitroalkanoic derivatives including oxazolidinones.⁶⁹

The same procedure was used for the synthesis of 3-(4-imidazolyl)pyrrolidines (*Sch 50971*) with H₃ agonist activity⁷⁰ and *N*-arylpyrrolidin-2-ones **25** (after an arylation step) with anti-HIV activity⁷¹ (Scheme 12).

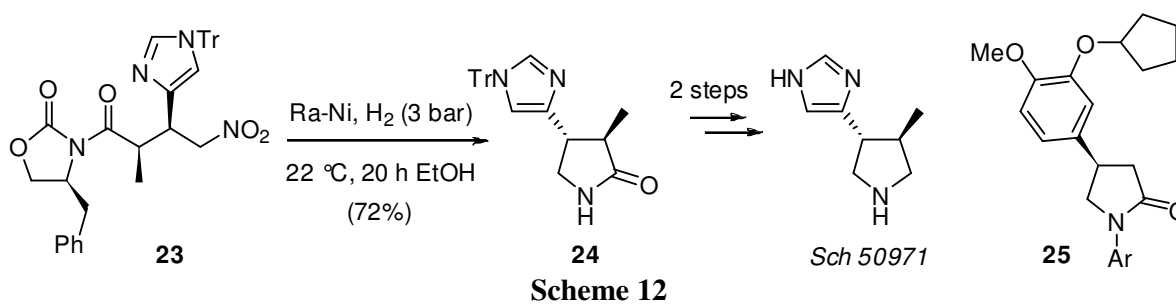
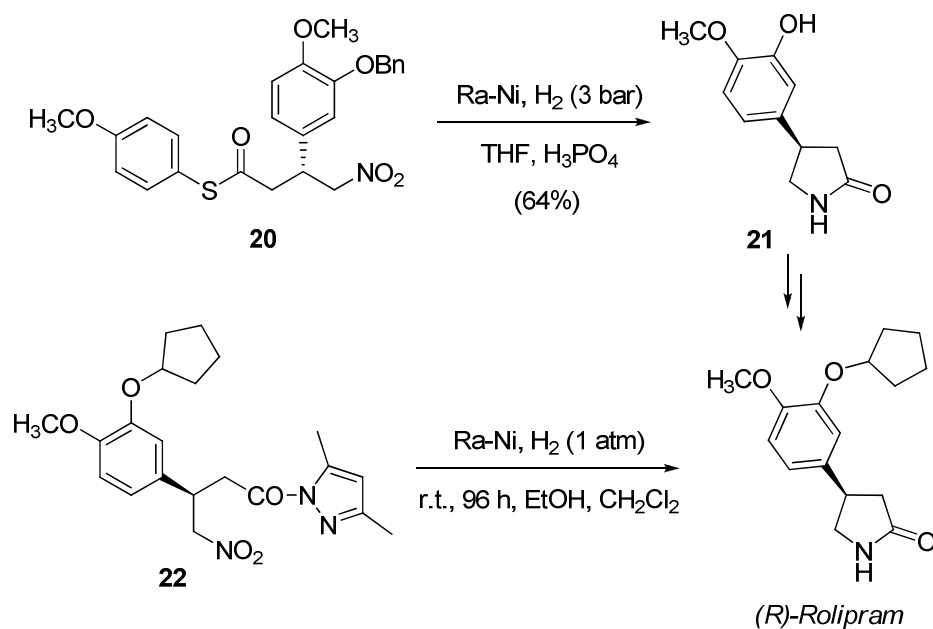

The reductive cyclization of γ -nitroamides with Raney-Ni provides a direct entry to γ -aminoacids through the intermediacy of polysubstituted pyrrolidin-2-ones,⁷² which are easily transformed into the targeted γ -aminoacids.⁷³ Incorporation of these compounds into γ -tetra and γ -hexapeptides induces the formation of 2.6₁₄ helices in the crystal state.⁷⁴

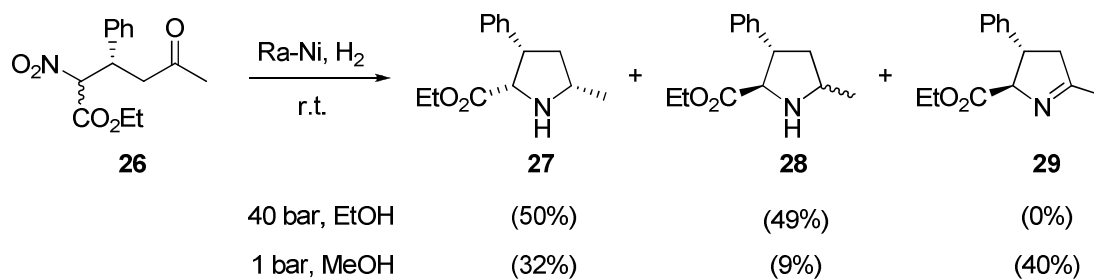

Scheme 13

Optically active pyrrolidines are obtained quantitatively from γ -nitroketones upon reduction by H₂/Raney-Ni in MeOH at 40 bar pressure. The procedure is compatible with a number of substituents; however, in the presence of a benzylic amine, much milder conditions have to be employed and the

reduction is carried out at atmospheric pressure and in EtOH as the solvent.⁷⁵ In the case of γ -nitro- γ -(ethoxycarbonyl)ketones **26** the product distribution is determined by the reaction conditions (Scheme 13). Whereas at atmospheric pressure and MeOH as the solvent, mixtures of pyrrolidines **27** and **28**, and 1-pyrroline **29** are obtained, at 40 bar and EtOH as the solvent, only pyrrolidine derivatives are formed.⁷⁶

The reduction of α -ketoesters with Raney-Ni is used to prepare key intermediates for the synthesis of kainic acid analogues (Scheme 14).⁷⁷ A similar approach can be performed with α -ketoamides.⁷⁸ In both cases, the reaction was carried out with enantiomerically pure compounds and no loss of optical purity was observed.

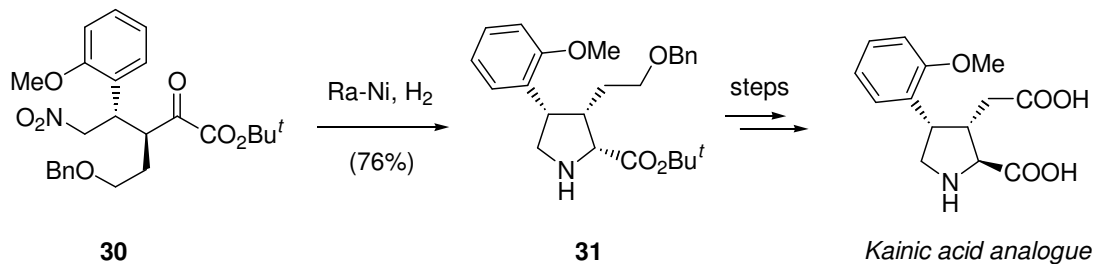

Scheme 14

The use of Raney-Ni in the presence of phosphoric acid and THF as a solvent induces the formation of 1-pyrrolines from γ -nitro- α -(ethoxycarbonyl)ketones.⁷⁹ In some cases, these compounds are not stable enough and they are reduced *in situ* with sodium (triacetoxy)borohydride or sodium cyanoborohydride.⁸⁰ The formation of 1-pyrrolines **33** is favoured in the case of cyclic ketones,⁸¹ probably due to the formation of a hindered Schiff base that is difficult to reduce.⁸²⁻⁸⁴ Again, further reduction with sodium cyanoborohydride yields the corresponding pyrrolidine **34** (Scheme 15).⁸⁵

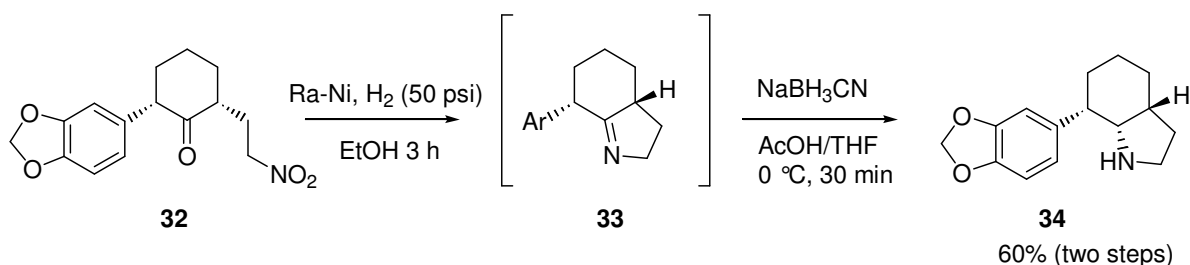

Scheme 15

2.1.2. Pd-catalyzed hydrogenation reactions

The hydrogenation of γ -nitroesters catalyzed by Pd-C takes place smoothly to give the corresponding 2-pyrrolidinones.⁸⁶ The reaction is usually performed at atmospheric pressure and room temperature and it is tolerated by a variety of protecting groups including carbamates for amino groups and silyl ethers for hydroxyl groups.⁸⁷ However, in many cases, it is necessary to reflux the mixture in toluene after the initial hydrogenation step in order to force cyclization of the γ -aminoester intermediate (Scheme 16).⁸⁸

In the presence of a free hydroxyl group, the hydrogenation takes place in good chemical yield and the pyrrolidine **38** is obtained (Scheme 17).⁸⁹ In fact, this approach has been employed by several authors in the

direct synthesis of the above-mentioned phosphodiesterase inhibitor (-)-Rolipram from the corresponding γ -nitro ester precursor.^{90,91}

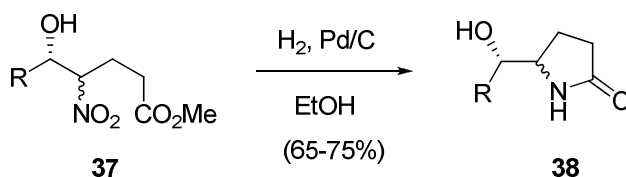
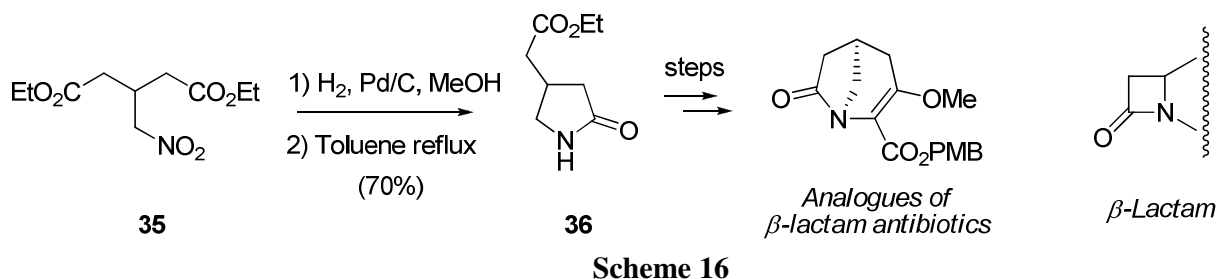

$\text{R} = \text{Ph}, 2\text{-MeOC}_6\text{H}_4, 4\text{-MeOC}_6\text{H}_4, 4\text{-O}_2\text{NC}_6\text{H}_4, 4\text{-MeC}_6\text{H}_4, 3\text{-MeOC}_6\text{H}_4$

Scheme 17

Iminosugars with an important activity as glycosidase inhibitors are accessible by hydrogenation of nitrosugars catalyzed by palladium on charcoal.⁹² This reaction represents the reductive cyclization of a γ -nitroaldehyde **39** (Scheme 18). Indeed, γ -nitroaldehydes furnish 3,4-disubstituted pyrrolidines under mild hydrogenation conditions. By using this methodology ($\text{H}_2/\text{Pd-C}$, 1 atm), spirocyclic oxetanes have been prepared from 2-(3-(nitromethyl)oxetan-3-yl)acetaldehyde.⁹³

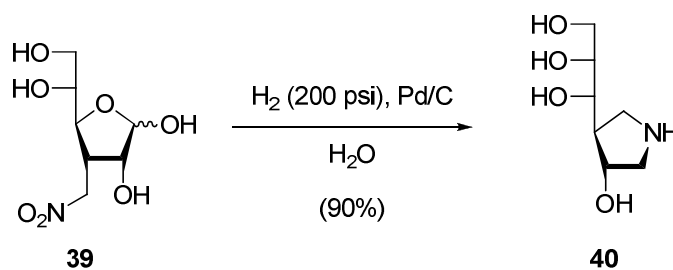

Scheme 18

Similarly, α -hydroxy- γ -nitroketones **41** yield 3-hydroxy substituted pyrrolidines **42**, under the same reaction conditions (Scheme 19).⁹⁴

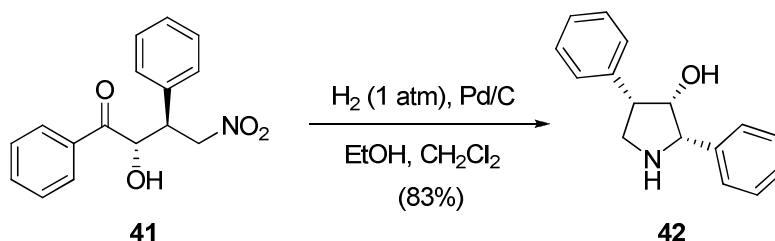

Scheme 19

Replacement of palladium on charcoal by Pearlman's catalyst (palladium hydroxide on charcoal) is also possible and very similar results are obtained. γ -Nitroaldehydes afford 3,4-disubstituted pyrrolidines in a reaction that is usually performed at atmospheric pressure.^{95,96} The reaction is compatible with several organic functionalities like esters⁹⁷ and, in some cases, pressures higher than atmospheric are employed as in the case of the imidazole-containing γ -nitroaldehyde **43**, precursor of the H₃ agonist Sch 50971 (Scheme 20).⁹⁸

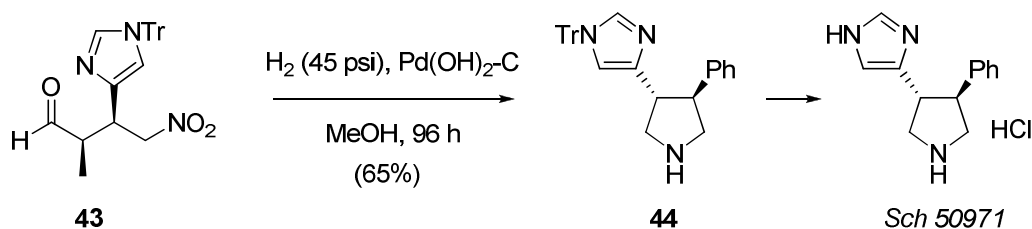

Scheme 20

The versatility of the reaction is extended to γ -nitroketones **45** from which pyrrolidines with an additional substituent at position 2 are obtained **46**.⁹⁹ In these cases, the reaction is usually carried out at higher pressures (60–90 psi) than with γ -nitroaldehydes⁹⁵ even though in some case it is possible to form the pyrrolidine at atmospheric pressure (Scheme 21).¹⁰⁰

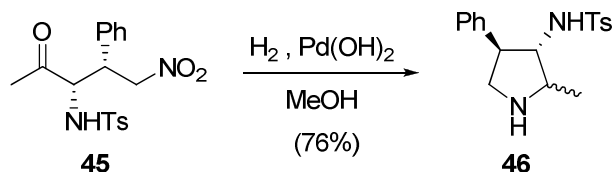

Scheme 21

The reaction conditions are only partially compatible with labile groups such as acetonides, since even though the protecting group is maintained, some epimerization is observed.¹⁰¹ γ -Nitroketones **47** can also form cyclic nitrones **48** upon hydrogenation catalyzed by Pd-C. The reaction takes place with very good yields in both EtOAc¹⁰² and methanol¹⁰³ as solvents (Scheme 22). On the other hand, when the reaction is performed with an acyclic ketone in ethanol as a solvent, at 35 psi for 3 days, a mixture of cyclic nitron and a cyclic hydroxylamine (coming from partial overreduction of the formed nitron)¹⁰⁴ is obtained. Nevertheless, the same reaction carried out at 1 atm for 15 hours yields quantitatively the cyclic nitron.¹⁰⁵

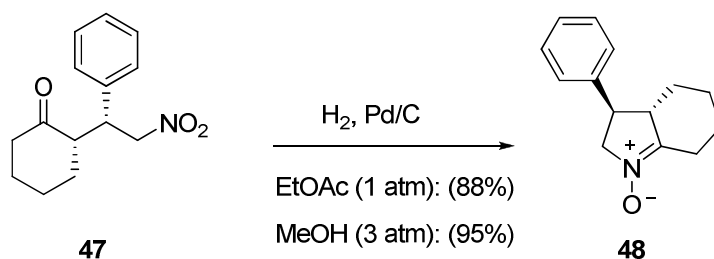

Scheme 22

2.1.3. Catalytic hydrogen transfer reactions

Cyclobutyl γ -aminoacids are obtained from precursor pyrrolidin-2-ones **50** prepared by treatment of cyclobutyl γ -nitroesters **49** with ammonium formate in the presence of palladium on charcoal.¹⁰⁶ The reaction, employed for preparing (*S*)-Pregabalin,¹⁰⁷ a therapeutic agents for treating epilepsy, anxiety and social phobia, is tolerated by acetonide groups and takes place in good chemical yield (Scheme 23).¹⁰⁸

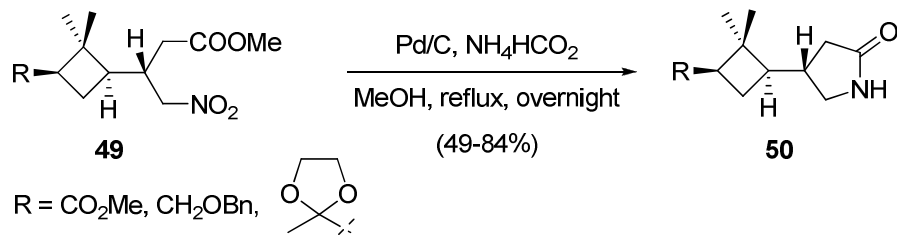

Scheme 23

However, the presence of additional esters functionalities **51b** results in low chemical yields as a consequence of the formation of undesired amides coming from reaction with ammonia formed during the reduction. The presence of such side products can be avoided by performing the reaction in an open vessel, where the ammonia concentration in solution is low (Scheme 24).¹⁰⁹ Both palladium on charcoal and palladium hydroxyde are usually used as suitable catalysts for promoting hydrogen transfer. In some particular cases, Raney-Ni is also employed.¹¹⁰

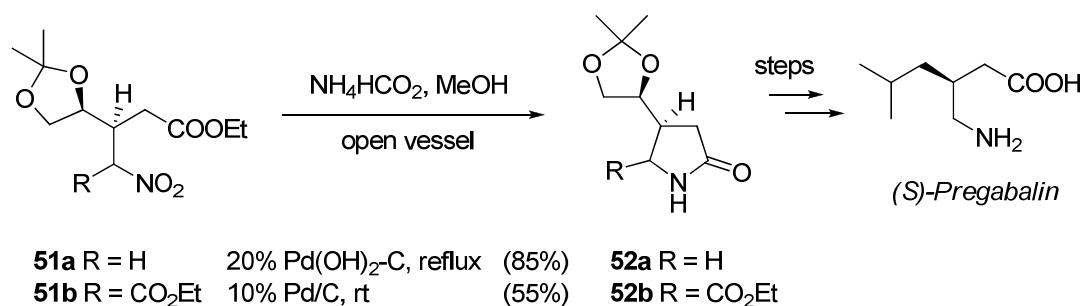

Scheme 24

2-Diethoxyphosphoryl-4-nitroalkanoates **53** lead to α -alkylidene- γ -lactams **55** in good chemical yields when treated with ammonium formate in the presence of Pd-C in THF as a solvent (Scheme 25).¹¹¹ The obtained compounds, which have been tested against L-1210, HL-60 and NALM-6 leukemia cells, can also be obtained in a mixture of THF-MeOH as solvent and starting the reaction at 0 °C.¹¹²

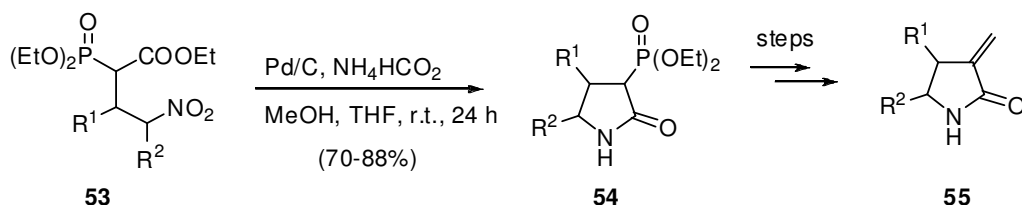

Scheme 25

This methodology has also been used in the synthesis of kainic acid analogues.¹¹³ In this case, reductive cyclization affords unstable hydroxylamine **57** which can be transformed into cyclic nitron **58** by treatment with POCl₃ and triethylamine in 42% yield. Obtainment of **58** from **57** is more conveniently achieved in 73% yield by treatment with HCl in methanol (Scheme 26).

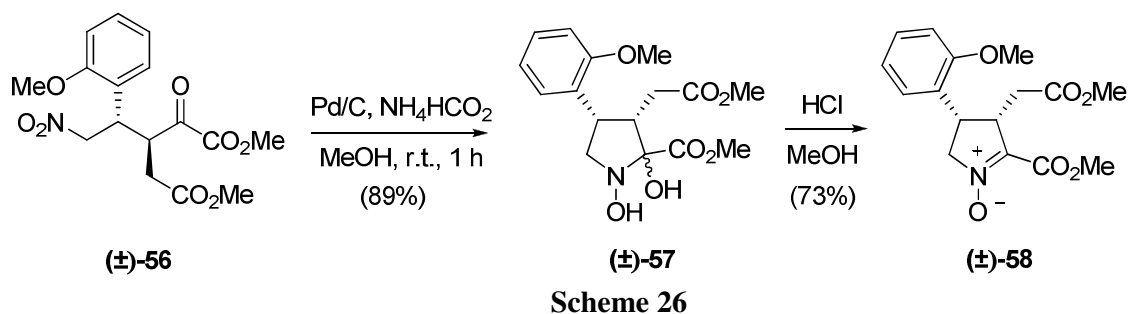

The reduction of γ -nitroketones with the system Pd(OAc)₂/Et₃SiH leads to hydroxyaminoketone intermediates, which cyclize to the corresponding cyclic nitrones.¹¹⁴ Whereas the palladium(II) acetate is used in a catalytic amount (5 mol%), an excess of triethylsilane is needed. The best results are obtained with 10 equiv, neither the use of 12 equiv nor the addition of 25 mol% of KF affords better results.¹¹⁵

2.2. Reduction with NiCl₂/NaBH₄

Nickel boride, prepared in *in situ* from 1.0 equiv of NiCl₂ and 5.0 equiv of sodium borohydride, acts as an efficient reducing reagent of γ -nitro diesters (r.t., 30 minutes). The reaction has been employed in the preparation of compound **61** en route to (*R*)-Baclofen.¹¹⁶ Other acid derivatives can also be used for the same transformation,¹¹⁷ which is also achieved in 7.5 hours and 84% yield (Scheme 27).¹¹⁸

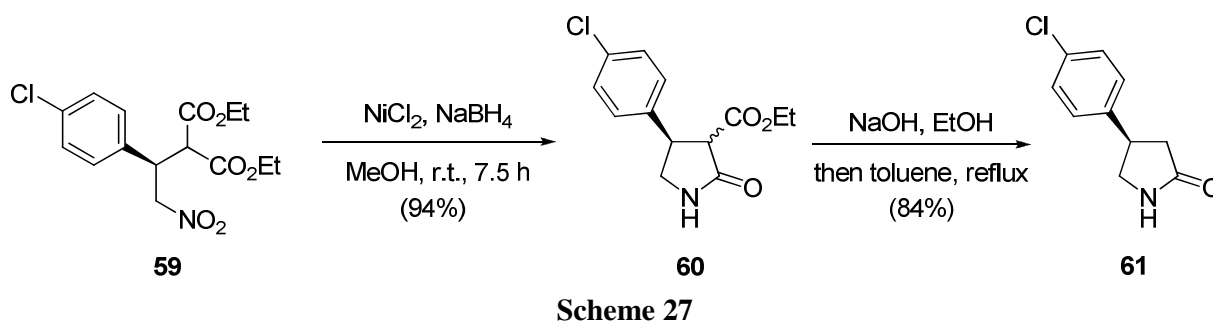

The same chemistry is used for preparing Rolipram in both racemic¹¹⁹ and enantiopure¹²⁰ series. Very similarly, bromo-¹²¹ and iodo-¹²² analogues of Baclofen **63** have been prepared by the same route. In all cases, good yields are obtained in the reductive cyclization step. The reaction can be carried out with both ethyl and phenyl esters and very good yields are obtained in both cases (Scheme 28).¹²³ A complete regioselectivity with respect to *tert*-butyl esters is observed.

3-Aryl-2-diethoxyphosphoryl-4-nitroalkanoates **53** (R¹=Ar) furnish the corresponding α -diethoxyphosphoryl- γ -lactams **54** in completely diastereoselective way by treatment with nickel(II) chloride (2.0 equiv) and sodium borohydride (10 equiv) in methanol (rt, 1 hour) (See Scheme 25).¹²⁴ The obtained

pyrrolidin-2-ones are suitable precursors of *N*-unsubstituted- α -methylene- γ -lactams **55** with potential cytotoxic activity. In some instances, the amino ester intermediate only cyclizes partially and further treatment with sodium carbonate is needed after the reduction step.¹²⁵

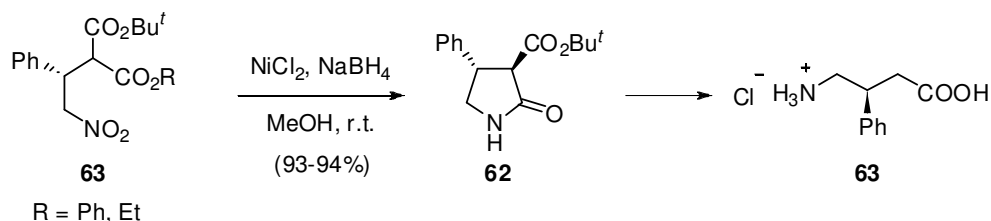

Scheme 28

When the reaction is performed with conformationally constrained γ -nitrolactones **64**, the aminolactone intermediate **65** can be trapped with trimethyl silyl triflate in the presence of Hünig's base (Scheme 29).¹²⁶

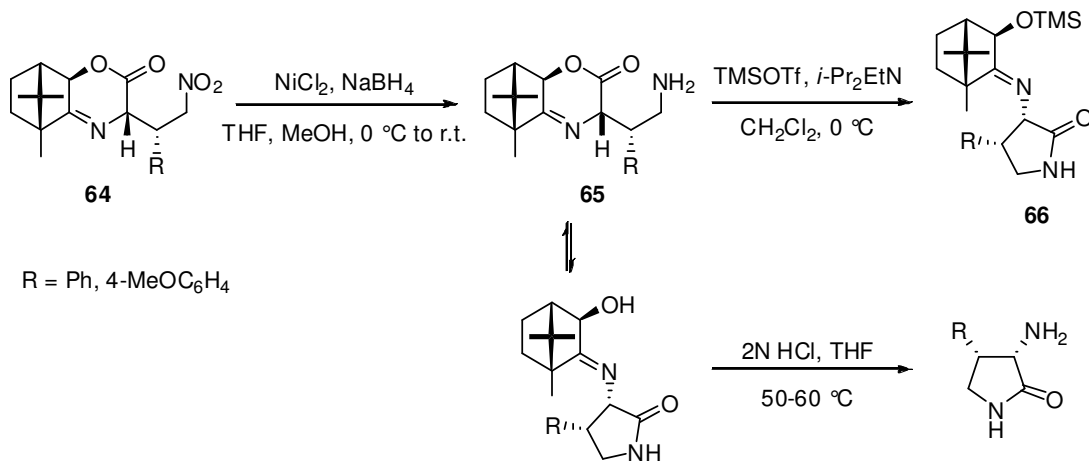

Scheme 29

2.3. Reduction with Zn/Brønsted acid system

The reduction of the nitro group in *tert*-butyl γ -nitroester **67** leads to isolable intermediate **68** in almost quantitative yield. Cyclization of **68** needs treatment with sodium methoxide in methanol. Under these conditions, lactam **69**, a precursor of β -lycorane, is obtained in an excellent chemical yield (Scheme 30).¹²⁷ The same reaction sequence is used with an epimeric substrate en route to γ -lycorane.¹²⁸

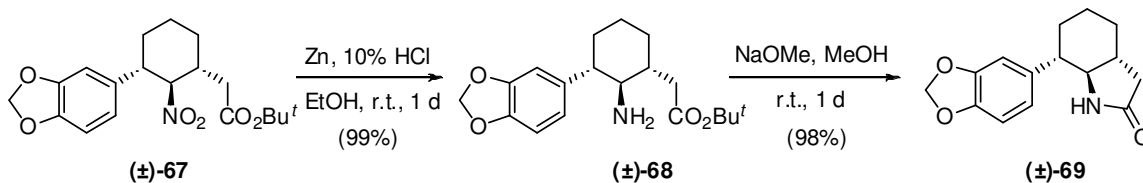

Scheme 30

On the other hand, in the case of methyl γ -nitroesters the cyclization of the γ -aminoester intermediate takes place spontaneously and the corresponding lactam is obtained in good yields. In some cases, this

procedure showed better results than other reduction reactions based on hydrogenation procedures.¹²⁹ When a second ester unit is present in the molecule **70**, it is possible to carry out a first reductive cyclization to form a lactam **71**, whose nitrogen can be induced to cyclize with the second ester unit by treatment with sodium methoxide in methanol (Scheme 31).¹³⁰

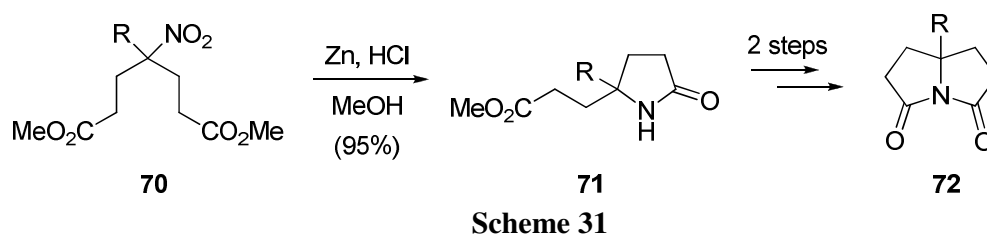

The reduction and *in situ* cyclization of polymer supported γ -nitroesters take place with yields in the range of 35–70%. It is noteworthy that during the cyclization step, the solid support is lost and the final γ -lactam goes into solution; as a consequence, different isolation methods are necessary depending on the substrate.¹³¹ In the case of γ -nitroamides, cyclization is produced with Zn in acetic acid, but only under reflux a clean reaction occurs.¹³² Similarly conjugated γ -nitroesters **73** afford 2-(ethoxycarbonylmethyl)-pyrrolidines **74** after refluxing in Zn/AcOH and subsequent basic treatment with NaOH (Scheme 32).¹³³

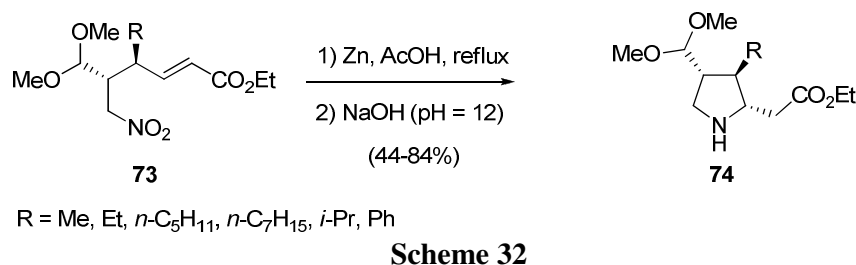

Fused pyrrolidines **76** and pyrrolidin-2-ones **77** are prepared by treating suitable precursors **75** with Zn in acetic acid. The reaction is quantitative in the case of aldehydes and ketones, and with esters a further basic treatment is necessary to complete cyclization (Scheme 33).¹³⁴ The reaction conditions are tolerated by free hydroxyl groups.

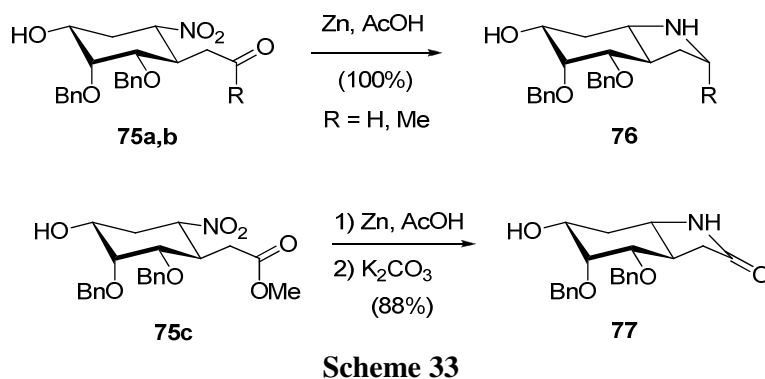

The reductive cyclization of γ -nitroketones upon treatment with Zn in acetic acid usually gives rise to the corresponding 2-substituted pyrrolidines.¹³⁵ The reaction can be carried out at room temperature but

heating could lead to quantitative yields in some case.¹³⁶ With γ -nitroaldehydes **78** and **80**, however, the obtainment of the corresponding 3,4-disubstituted pyrrolidines **79** and **81** is only achieved after further reductive treatment with sodium borohydride¹³⁷ or sodium cyanoborohydride (Scheme 34);¹³⁸ such a treatment is probably needed because of the formation of 1-pyrroline intermediate.

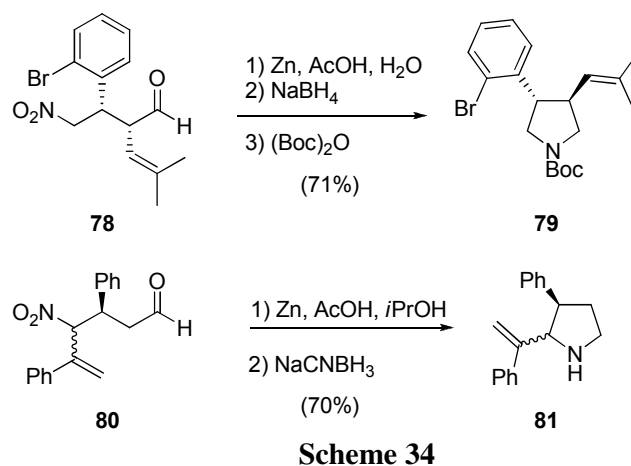

Mixtures of cyclic nitrones **83** and 1-pyrrolines **84** are obtained upon treatment of γ -nitroketones and γ -nitroaldehydes with Zn in acetic acid (Scheme 35).¹³⁹

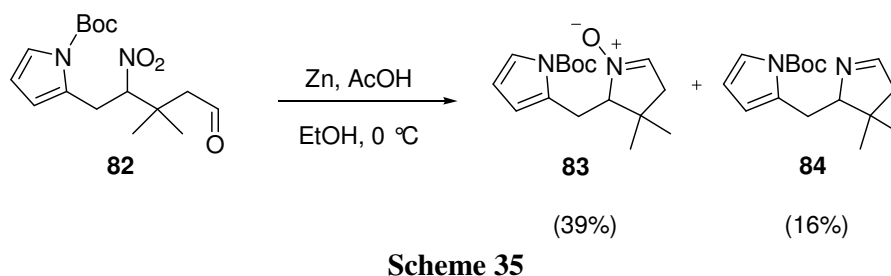

On the other hand, when the reaction was carried out with γ -nitroesters and ammonium formate as a hydrogen transfer reagent, mixtures of pyrrolidin-2-ones and their *N*-hydroxy derivatives are obtained. The *N*-hydroxypyrrolidin-2-ones are the only product of the reaction if formic acid is used.¹³⁹ 1-Pyrrolines are formed from γ -nitroketones by treatment with Zn and ammonium chloride in THF-water as solvent.¹⁴⁰ Under similar conditions, the same authors reported the obtainment of a cyclic nitrone.¹⁴¹ With γ -nitroketones **85** only 1-pyrrolines **86** are obtained with ammonium formate if THF is used as a solvent (Scheme 36, **86a-c**).¹⁴² The resulting products have been used in the synthesis of chlorins and ¹³C-marked substrates for biological studies.¹⁴³

Interestingly, the same authors report the obtainment of cyclic nitrone **87** from nitroketone **85a** with Zn/NH₄Cl in THF-H₂O at 0 °C.¹⁴⁴ The same result was obtained with Zn in acetic acid in either MeOH¹⁴⁵ or EtOH¹⁴⁶ as a solvent.

In general, the reductive cyclization of γ -nitroketones to nitrones by using Zn as electron source can be carried out with ammonium chloride¹⁴⁷ or acetic acid¹⁴⁸ as proton sources. In all cases, protic solvents (MeOH or THF-H₂O) are also employed. With γ -nitro- α,β -unsaturated ketones, exocyclic conjugated cyclic

nitrones are obtained.¹⁴⁹ The system Zn/NH₄Cl in THF-H₂O allows the preparation of a number of cyclic nitrones **89** of synthetic utility¹⁵⁰ and in high diastereomeric ratio (d.r. >98:2) (Scheme 37).¹⁵¹

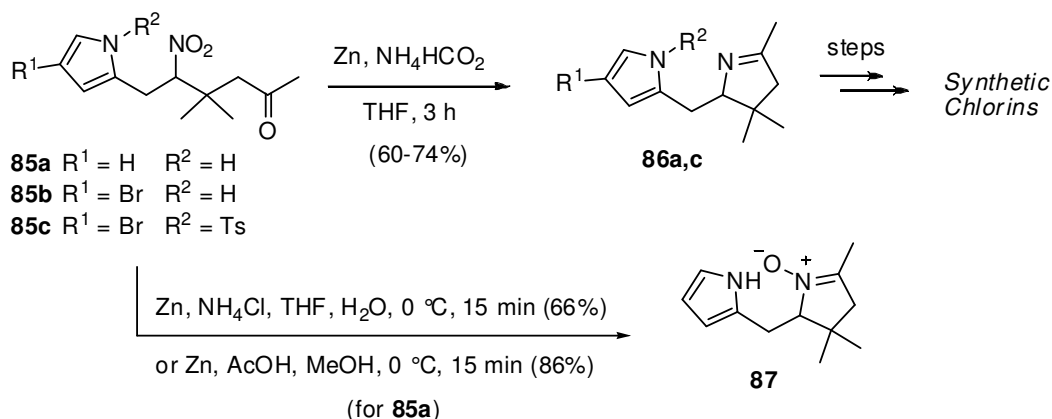

Scheme 36

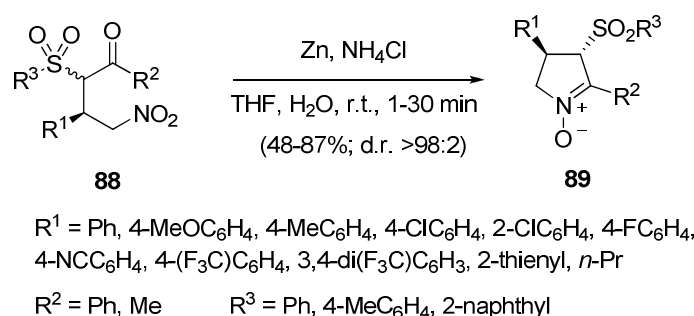

Scheme 37

Similarly, a series of 3,5-disubstituted-5-(ethoxycarbonyl) cyclic nitrones, used for evaluation as radical scavengers in trapping the superoxide radical, are prepared from γ -nitroaldehydes by treatment with Zn and ammonium chloride in aqueous methanol.¹⁵² Compounds bearing one¹⁵³ or two¹⁵⁴ ester units are prepared demonstrating the compatibility of the methodology with the presence of a variety of ester functionalities.¹⁵⁵ Similarly, a series of carbamoyl¹⁵⁶ and methylcarbamoyl¹⁵⁷ groups can also be present in the molecule. Both aryl and alkyl groups are incorporated into the centre adjacent to the nitron nitrogen.¹⁵⁸ Deuterated analogues of the free radical trap DEPMPO and have been synthesized by the same method but using deuterated reagents.¹⁵⁹

2.4. Reduction with Fe/Brønsted acid system

The γ -nitroesters **90**, obtained from acetates of Baylis-Hillman adducts, are easily transformed into γ -lactams **91** by treatment with Fe in acetic acid (Scheme 38).¹⁶⁰ The same reaction conditions, however, furnish mixtures of 1-pyrrolines **93** and cyclic nitrones **94** when applied to γ -nitroketones **92**.¹⁶¹ If two carbonyl functions are present in the molecule, different products are obtained depending on functionalities. With two ester units, pyrrolidin-2-ones are obtained in a complete regioselective manner. On the other hand, in the presence of a ketone unit and an ester functionality, cyclization only takes place through the ketone unit and mixtures of 1-pyrrolines and cyclic nitrones are obtained.¹⁶²

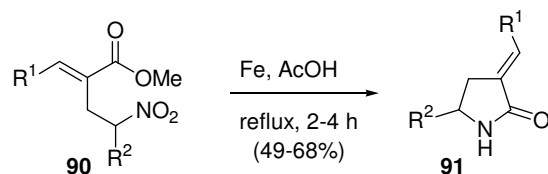

$\text{R}^1 = \text{Ph}, 4\text{-MeC}_6\text{H}_4, 4\text{-EtC}_6\text{H}_4, 4\text{-ClC}_6\text{H}_4, 4\text{-MeOC}_6\text{H}_4, 2\text{-ClC}_6\text{H}_4,$
 1-naphthyl, *n*-propyl, *n*-hexyl
 $\text{R}^2 = \text{Me}, \text{Et}$

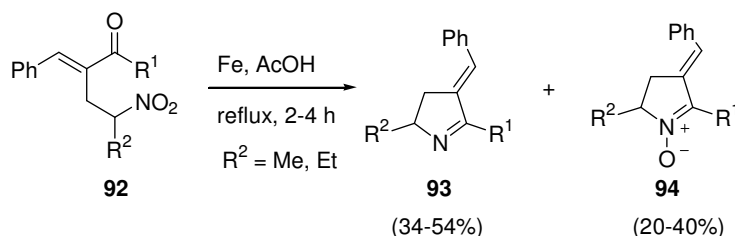

Scheme 38

The obtainment of cyclic nitrones **96** as the only products of the reaction is possible by using Fe/HCl in ethanol at reflux from γ -nitroketones **95**. Under these conditions double and triple bonds survive and nitrones are obtained in moderate to good chemical yields (Scheme 39).¹⁶³

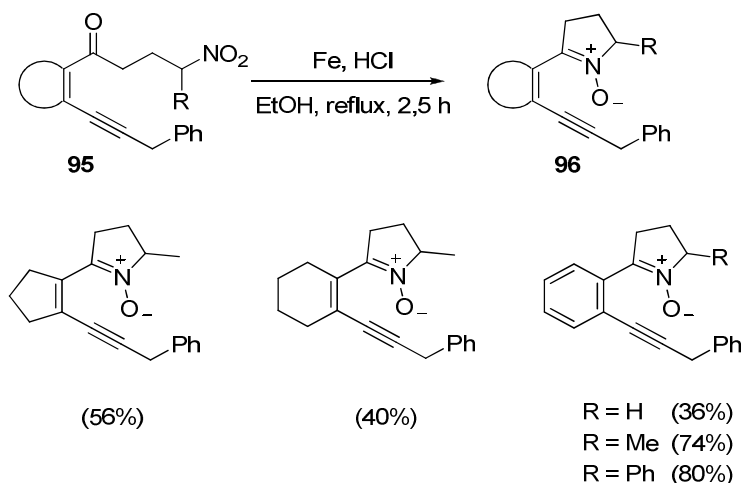

Scheme 39

2.5. Reduction with TiCl_3

1-Pyrroline **86a** (Scheme 36) and related compounds are also obtained by treatment of the corresponding γ -nitroketones **97** in THF with sodium methoxide followed by buffered (pH=6) titanium(III) chloride. However, the 1-pyrrolines are obtained in low yields (20–30%).¹⁶⁴ Higher yields (40–50%) are observed with compounds bearing an aromatic ring at the pyrrole unit¹⁶⁵ although the presence of an acetal unit adjacent to the carbonyl group as in **97a–c** again results in low product yields (28% for **33a**¹⁶⁶ and **33b**,¹⁶⁷ and 46% for **33c**¹⁶⁸) (Scheme 40). The presence of a 3,4-disubstituted pyrrole unit is also possible and synthetically useful chemical yields are obtained.¹⁶⁹

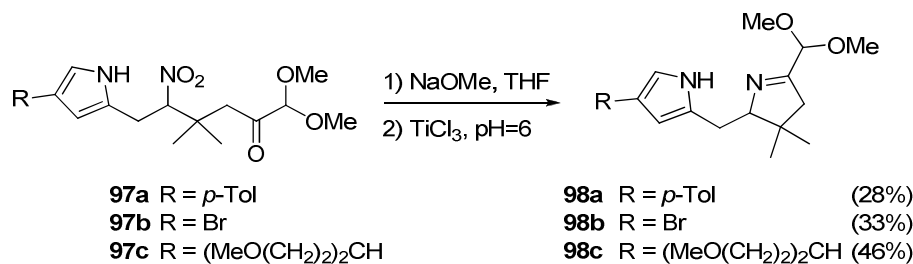

Scheme 40

2.6. Reduction with SnCl₂

A two step sequence consisting of the reduction of a γ -nitroester with tin(II) chloride and further cyclization in refluxing ethanol is employed for preparing 4-arylpyrrolidin-2-ones **100** (Scheme 41).¹⁷⁰ Compounds **100** are precursors of agonist of α_{1A} adrenergic receptor.

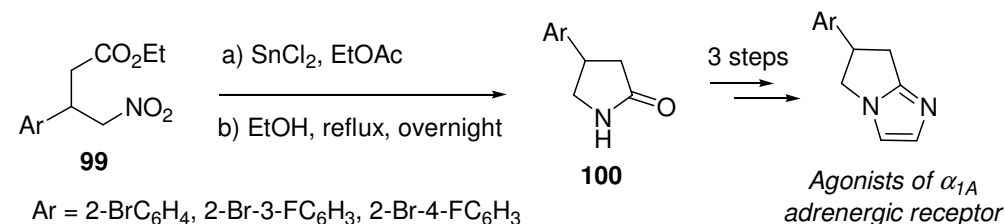

Scheme 41

3. Synthesis of five-membered nitrogen heterocycles from β -cyanocarbonyl compounds

The reduction of β -cyanocarbonyl compounds can be directed to the synthesis of γ -aminocarbonyl derivatives, which it is expected to cyclize spontaneously to the corresponding five-membered nitrogen heterocycles. In principle, as in the case of γ -nitrocarbonyl derivatives, depending on the carbonyl functionality, pyrrolidines, 1-pyrrolines and pyrrolidin-2-ones could be obtained, the only difference being that no substituents are possible at C-5 of the heterocycle (Scheme 42). The access to β -cyanocarbonyl compounds is guaranteed because they are easy to prepare *via* a Michael addition of cyanide to the corresponding α,β -unsaturated carbonyl compound.¹⁷¹⁻¹⁷⁷

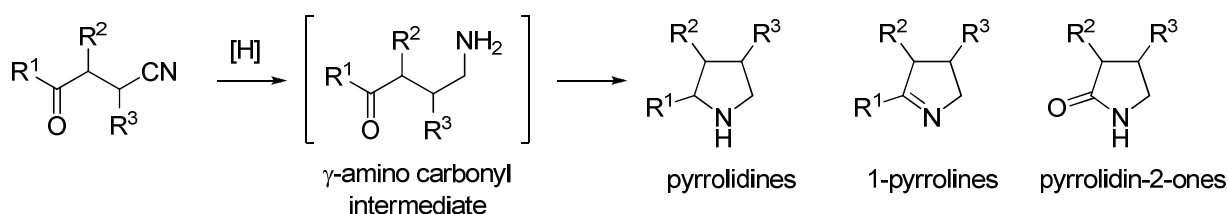

Scheme 42

3.1. Hydrogenation

3.1.1. Catalyzed by Raney nickel

Fused aromatic or heteroaromatic pyrrolidin-2-ones are prepared by reductive cyclization of *o*-cyano-benzoates and related compounds through hydrogenation in the presence of Raney-Ni. Pressures of ca. 6 bar

are needed and the reaction takes place smoothly in a mixture of absolute ethanol-dry toluene as the solvent (Scheme 43).¹⁷⁸

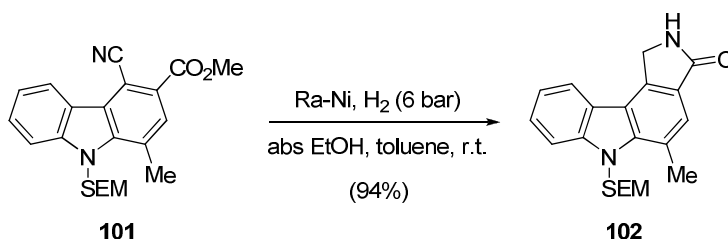

Scheme 43

On the other hand, a similar reaction carried out in DMF for 7 hours at 45 psi yields the pyrrolidin-2-one as a single product in 28% yield.¹⁷⁹ Compound **102** and related derivatives, prepared by this approach, are potent inhibitors of pol(ADP-ribose)polymerase-I.¹⁸⁰ Similar analogues with two indole nuclei thus mimicking the natural product (+)-K-252a are also prepared and show a potent activity as MLK1/3 inhibitors.¹⁸¹ A variety of pyrrolocarbazoles similar to **102** are now accessible by this procedure and they can be checked against several tumor cell lines including murine leukemia L1210 and human colon carcinoma HT29 and HTC116.¹⁸² Hydrogenation with Raney-Ni as a catalyst is compatible with the presence of benzyl ethers and, consequently, in the case it is necessary to cleavage the benzyl group, an additional step using a palladium-based catalyst (Pd-C or Pd(OH)₂-C) is necessary.¹⁸³ By using DMF-MeOH as a solvent, derivatives incorporating a pyrazole unit into the structure **104** are prepared, although in low yield, and they were found to be potent inhibitors of DLK (Scheme 44).¹⁸⁴

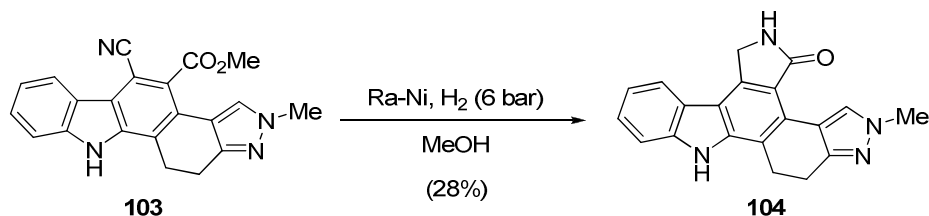

Scheme 44

Treatment of β -cyanoesters with H₂/Ra-Ni is also possible in a mixture of methanol-ammonium hydroxide. The reaction takes place at room temperature at 40 psi and the expected pyrrolidin-2-one is obtained in good yield.¹⁸⁵ By only using methanol as a solvent the reaction goes to completion (92% yield) in 48 hours at 50 psi.¹⁸⁶ Enantiomerically pure β -cyanoester **105** is subjected to hydrogenation in the presence of Raney-Ni to afford the pyrrolidin-2-one **106**. It should be noted that addition of acetic acid is necessary to avoid partial racemization which can be caused by the alkalinity of the catalyst (usually prepared from Ni-Al alloy and NaOH_{aq}).

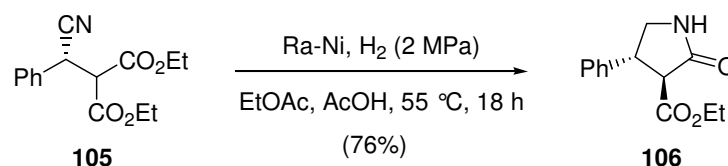

Scheme 45

In fact, by using these reaction conditions, compound **106** is obtained without any loss of optical purity (Scheme 45).¹⁸⁷ The same transformation can be done by employing 10% Pd-C as a catalyst.

Reductive cyclization with Raney-Ni is also possible with sodium salts of carboxylic acids; also in this case, the presence of ammonium hydroxide is needed for maintaining the basic medium.¹⁸⁸ If both a sodium salt of a carboxylic acid and an ester unit are present in the molecule, cyclization takes place selectively with the ester moiety.¹⁸⁹ The reaction is also possible with β -cyanoketones and substituted pyrrolidines are obtained in good yields.¹⁹⁰ In some cases, however, the product of the reaction is the 1-pyrroline and an additional reduction step with sodium cyanoborohydride is required for obtaining the totally reduced pyrrolidine (Scheme 46).¹⁹¹ Depending on the particular substrate, the benzyl group present in the molecule is hydrogenated completely or partially.¹⁹² This two-step protocol is compatible with the presence of ester units in the molecule, which remain unaffected.¹⁹³

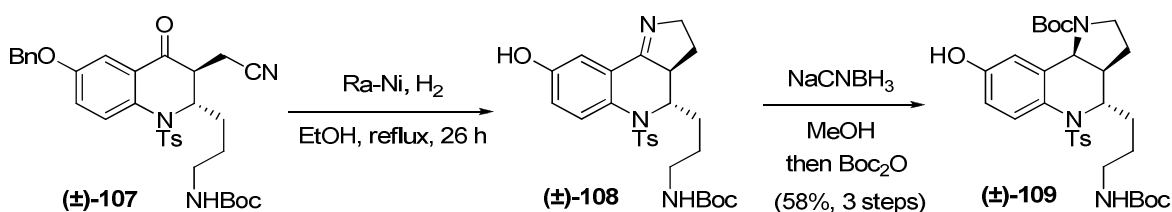

Scheme 46

3.1.2. Catalyzed by platinum oxide

The hydrogenation of β -cyanoamide **110** catalyzed by platinum(II) oxide takes 70 hours in providing pyrrolidin-2-one **111** in 75% yield (Scheme 47).¹⁹⁴ Compound **111** is an advanced intermediate in the synthesis of *ent*-pregabalin. The natural product pregabalin is prepared through hydrogenation, catalyzed by platinum(II) oxide, of a β -cyano carboxylic acid.¹⁷³

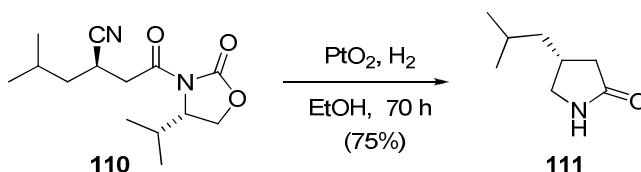

Scheme 47

On the other hand, hydrogenation of **112** under similar conditions afforded the γ -aminoester intermediate **113**, which is cyclized *in situ* to **114** by treatment with sodium carbonate at 60 °C.¹⁹⁵ Compound **114** is a precursor for the preparation of peptidomimetic severe acute respiratory syndrome chymotrypsin-like protease inhibitors (Scheme 48).¹⁹⁶ Cyclization of γ -aminoester intermediates can also be carried out with lithium hydroxide in THF-H₂O.¹⁹⁷

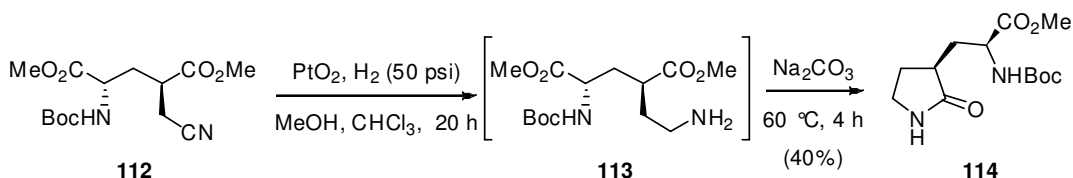

Scheme 48

3.1.3. Catalyzed by palladium

The synthesis of compound **114** is also achieved by hydrogenating **112** at 70 psi in the presence of palladium on charcoal and acetic acid as a solvent. As in the reaction catalyzed by platinum(II) oxide a further treatment under basic conditions (triethylamine, THF, 60 °C) is needed for completing the cyclization step. In this case, **114** was obtained in 61% yield, higher than in the previous example.¹⁹⁸ In general, if the reaction is performed in AcOH, an additional cyclization step promoted by a base, usually triethylamine, is needed¹⁷³ as demonstrated by the synthesis of a precursor of β -phenyl-GABA.¹⁷² On the contrary, hydrogenation of **115** under similar conditions but in the presence of HCl leads directly to the expected pyrrolidin-2-one **116** (Scheme 49).¹⁹⁹

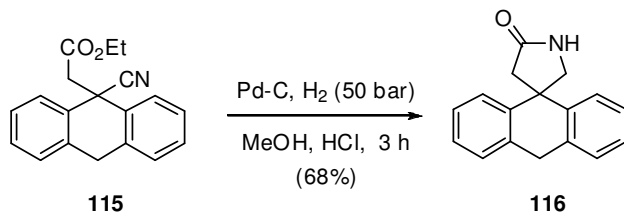

Scheme 49

3.1.4. Catalyzed by rhodium

Hydrogenation of the β -cyanoester **117** with rhodium on alumina affords a mixture of the expected 3-substituted-pyrrolidin-2-one **118** and the open-chain derivative **119** in which the trifluoroacetamido group is migrated to the emerging free amino group from the reduction of the cyanide (Scheme 50).²⁰⁰

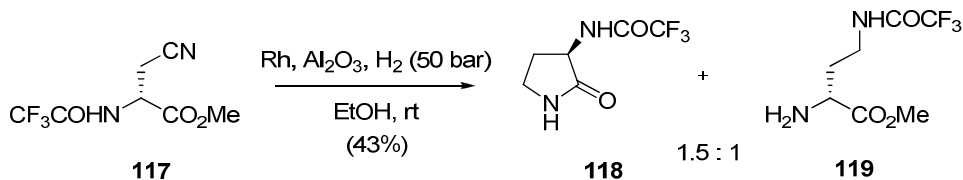

Scheme 50

3.2. Reduction with NiCl₂/NaBH₄

The synthesis of both enantiomers of Baclofen is achieved by reductive cyclization of the corresponding β -cyanoamide with nickel(II) chloride in the presence of an excess of sodium borohydride. By using the Evans' oxazolidinone as a chiral auxiliary, the (*S*)-isomer is obtained in 99% e.e.,¹⁹⁴ while the (*R*)-isomer is obtained with 96% e.e. by asymmetric hydrogenation of a racemic ketoester and further reductive cyclization under the same reaction conditions.²⁰¹ A β -trimethylsiloxy- β -cyanoester **120** is converted into a 3,4,4-trisubstituted pyrrolidin-2-one **122** in a two steps sequence based on a reduction with nickel boride in which the γ -aminoester intermediate **121** is isolated as a benzylcarbamate (Scheme 51).

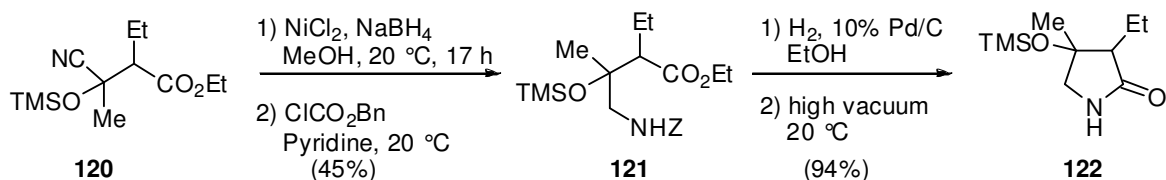

Scheme 51

Cyclization of the isolated intermediate is achieved by sequential hydrogenation and cyclization reactions at high vacuum.²⁰²

3.3. Reduction with $\text{CoCl}_2/\text{NaBH}_4$

4-Substituted pyrrolidin-2-ones are easily prepared from the corresponding β -cyanoesters by treatment with CoCl_2 in the presence of an excess of sodium borohydride.²⁰³ The reaction conditions are not tolerated by double bonds, which are hydrogenated simultaneously as illustrated in Scheme 52.²⁰⁴

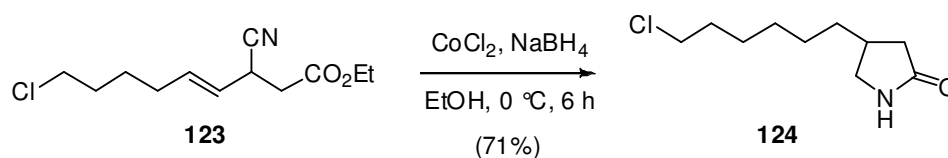

Scheme 52

When β,β -disubstituted- β -cyanoesters are used as starting compounds,²⁰⁵ pyrrolidin-2-ones with a quaternary centre at C-4 are obtained.²⁰⁶ Hindered β -cyanoesters **125** are reduced under more drastic conditions and the resulting γ -aminoester **126** does not cyclize spontaneously. In such a case, cyclization to the spiro compounds **127** can be promoted by refluxing in toluene in the presence of trimethylaluminum (Scheme 53).²⁰⁷

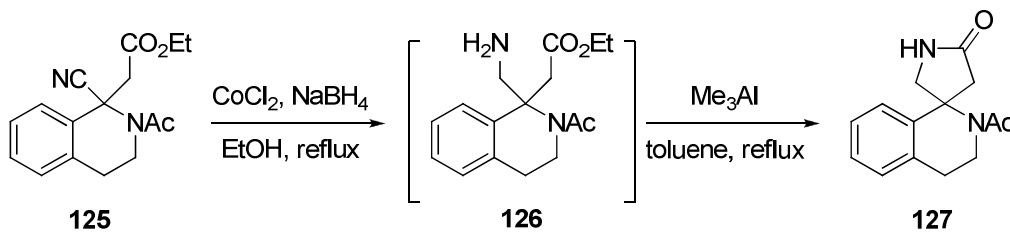

Scheme 53

Treatment of compound **112** in methanol with cobalt(II) chloride in the presence of an excess of sodium borohydride affords **114** in 47% yield. Under these conditions no additional treatment is necessary and the pyrrolidin-2-one **114** is obtained directly (See Scheme 48).²⁰⁸

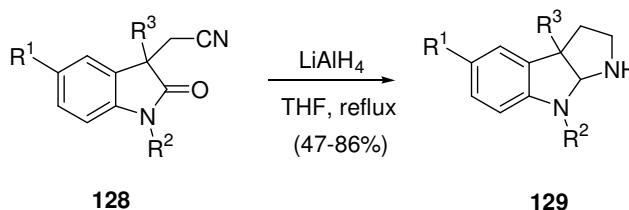

$\text{R}^1 = \text{H, OMe}$
 $\text{R}^2 = \text{Me, Bn}$
 $\text{R}^3 = \text{isoprenyl, 4-pyridylmethyl}$

Scheme 54

3.4. Reduction with LiAlH₄

The reduction and concomitant cyclization of β -cyanolactams **128** is achieved with lithium aluminum hydride in THF at reflux.²⁰⁹ Under these conditions, a variety of fused pyrrolidines **129** are obtained in moderate chemical yields (Scheme 54).²¹⁰

The reductive cyclization of β -cyanoketones is also possible by forming the silyl enolate derived from the ketone moiety and treating with LiAlH₄ in THF.²¹¹

4. Concluding remarks

Five-membered nitrogen heterocycles are present in a great number of natural products and therapeutic agents. In addition, they are key synthetic intermediates for preparing a variety of compounds of biological importance. Because of these reasons, it is of crucial importance to develop efficient synthetic methods that allow a facile access to such structures. The reductive cyclization of γ -nitrocarbonyl derivatives and β -cyanocarbonyl compounds is a direct entry to several five-membered nitrogen heterocycles, mainly pyrrolidines. The transformation can be carried out with a variety of reducing agents that guarantee a great compatibility with a high number of organic functionalities and protecting groups. It is possible to use hydrogenation methods with a variety of catalysts including hydrogen catalytic transfer processes. Classical reducing systems consisting of a couple formed by a metal (Zn, Fe) and a Brønsted acid (HCl, AcOH) are also useful in that reaction as well as other systems based on low valent transition metals or the typical lithium aluminum hydride. Regarding the substrates, any type of carbonyl derivative can be used, that is aldehydes, ketones, esters and other acid derivatives. Depending on the combination of the reducing system and the substrate, pyrrolidines, 1-pyrrolines, pyrrolidin-2-ones and cyclic nitrones can be obtained. Of particular interest is the possibility of obtaining cyclic nitrones, which are important synthetic intermediates. Finally, but not less important, also enantiomerically pure five-membered nitrogen heterocycles can be prepared by these methods since the processes do not affect the optical purity of starting materials. By the way, the accessibility of enantiopure γ -nitrocarbonyl derivatives and β -cyanocarbonyl compounds is guaranteed by recent advances in asymmetric processes with particular attention to organocatalytic methods. The reductive cyclization of these compounds, a simple and versatile reaction, will continue being applied, without any doubt, in many synthetic procedures leading to the preparation of compounds of biological and therapeutic interest.

Acknowledgments

The authors thank the Spanish Ministry of Science and Innovation (MICCIN, Madrid, Spain) and FEDER program (European Community) for financial assistance in the form of a project (CTQ2010-19606). The regional Government of Aragon (Zaragoza, Spain) is also gratefully acknowledged (Consolidated Research Groups program). D.S. thanks the Spanish Council for Scientific Research (CSIC. JAE-Pre) for a grant.

References

1. O'Hagan, D. *Nat. Prod. Rep.* **2000**, *17*, 435.
2. Pinder, A. R. *Nat. Prod. Rep.* **1989**, *6*, 515.
3. Pinder, A. R. *Nat. Prod. Rep.* **1992**, *9*, 17.
4. O'Hagan, D. *Nat. Prod. Rep.* **1997**, *14*, 637.

5. Humphrey, A. J.; O'Hagan, D. *Nat. Prod. Rep.* **2001**, *18*, 494.
6. Galliford, C. V.; Scheidt, K. A. *Angew. Chem. Int. Ed.* **2007**, *46*, 8748.
7. Patel, A. V.; Crabb, T. A. In *Second supplements to the 2nd edition of Rodd's Chemistry of Carbon Compounds*; Sainsbury, M., Ed.; Elsevier: Amsterdam 1997; Vol. 4 (Part A), p. 457.
8. Robins, D. J. In *Second supplements to the 2nd edition of Rodd's Chemistry of Carbon Compounds*; Sainsbury, M., Ed.; Elsevier: Amsterdam 1997; Vol. 4 (Part A), p. 1.
9. Pearson, W. H. *Stud. Nat. Prod. Chem.* **1988**, *1*, 323.
10. Hudlicky, T.; Seoane, G.; Price, J. D.; Gadamasetti, K. G. *Synlett* **1990**, 433.
11. Enders, D.; Thiebes, T. *Pure Appl. Chem.* **2001**, *73*, 573.
12. Yoda, H. *Curr. Org. Chem.* **2002**, *6*, 223.
13. El-Ashry, E.-S. H.; El Nemr, A. *Carbohydr. Res.* **2003**, *338*, 2265.
14. Pyne, S. G.; Davis, A. S.; Gates, N. J.; Hartley, J. P.; Lindsay, K. B.; Machan, T.; Tang, M. *Synlett* **2004**, 2670.
15. Bellina, F.; Rossi, R. *Tetrahedron* **2006**, *62*, 7213.
16. Huang, P.-Q. *Synlett* **2006**, 1133.
17. Amer, F. A.-K.; Hammouda, M.; El-Ahl, A.-A. S.; Abdel-Wahab, B. F. *J. Heterocycl. Chem.* **2008**, *45*, 1549.
18. Companyo, X.; Alba, A.-N.; Rios, R. In *Targets in Heterocyclic Systems*; Attanasi, O. A.; Spinelli, D., Eds.; Società Chimica Italiana: Rome, 2009; Vol. 13, p. 147.
19. Vicario, J. L.; Badia, D.; Carrillo, L.; Ruiz, N.; Reyes, E. In *Targets in Heterocyclic Systems*; Attanasi, O. A.; Spinelli, D., Eds.; Società Chimica Italiana: Rome, 2008, Vol. 12, p. 302.
20. Toyooka, N.; Nemoto, H. *New Methods Asymmetric Synth. Nitrogen Heterocycl.* **2005**, 149.
21. Broggini, G.; Zecchi, G. *Synthesis* **1999**, 905.
22. Stocker, B. L.; Dangerfield, E. M.; Win-Mason, A. L.; Haslett, G. W.; Timmer, M. S. M. *Eur. J. Org. Chem.* **2010**, 1615.
23. Pichon, M.; Figadere, B. *Tetrahedron: Asymmetry* **1996**, *7*, 927.
24. Flanagan, D. M.; Joullie, M. M. *Heterocycles* **1987**, *26*, 2247.
25. Esker, J. L.; Newcomb, M. *Adv. Heterocycl. Chem.* **1993**, *58*, 1.
26. Merino, P.; Franco, S.; Merchan, F. L.; Tejero, T. *Synlett* **2000**, 442.
27. Najera, C.; Sansano, J. M. *Angew. Chem. Int. Ed.* **2005**, *44*, 6272.
28. Husinec, S.; Savic, V. *Tetrahedron: Asymmetry* **2005**, *16*, 2047.
29. Coldham, I.; Hufton, R. *Chem. Rev.* **2005**, *105*, 2765.
30. Pearson, W. H.; Stoy, P. *Synlett* **2003**, 903.
31. Kanemasa, S.; Tsuge, O. *Adv. Cycloaddit.* **1993**, *3*, 99.
32. Pandey, G.; Banerjee, P.; Gadre, S. R. *Chem. Rev.* **2006**, *106*, 4484.
33. Castro, B. R. *Org. React.* **1983**, *29*, 1.
34. Hughes, D. L. *Org. React.* **1992**, *42*, 335.
35. Wolfe, J. P. *Eur. J. Org. Chem.* **2007**, 571.
36. Minatti, A.; Muniz, K. *Chem. Soc. Rev.* **2007**, *36*, 1142.
37. Baxter, E. W.; Reitz, A. B. *Org. React.* **2002**, *59*, 1.
38. Roca-Lopez, D.; Sadaba, D.; Delso, I.; Herrera, R. P.; Tejero, T.; Merino, P. *Tetrahedron: Asymmetry* **2010**, *21*, 2561.
39. Revuelta, J.; Cicchi, S.; Goti, A.; Brandi, A. *Synthesis* **2007**, 485.
40. Palomo, C.; Aizpurua, J. M.; Oiarbide, M.; Garcia, J. M.; Gonzalez, A.; Odriozola, I.; Linden, A. *Tetrahedron Lett.* **2001**, *42*, 4829.
41. dos Santos, A. A.; Clososki, G. C.; Simonelli, F.; de Oliveira, A. R. M.; Marques, F. d. A.; Zarbin, P. H. G. *J. Braz. Chem. Soc.* **2001**, *12*, 673.
42. Tsymbalov, S.; Hagen, T. J.; Moore, W. M.; Jerome, G. M.; Connor, J. R.; Manning, P. T.; Pitzele, B. S.; Hallinan, E. A. *Bioorg. Med. Chem. Lett.* **2002**, *12*, 3337.
43. Felluga, F.; Gombac, V.; Pitacco, G.; Valentin, E. *Tetrahedron: Asymmetry* **2005**, *16*, 1341.
44. Whitlock, G. A.; Brennan, P. E.; Roberts, L. R.; Stobie, A. *Bioorg. Med. Chem. Lett.* **2009**, *19*, 3118.
45. Blakemore, D. C.; Bryans, J. S.; Carnell, P.; Chessum, N. E. A.; Field, M. J.; Kinsella, N.; Kinsora, J. K.; Osborne, S. A.; Williams, S. C. *Bioorg. Med. Chem. Lett.* **2010**, *20*, 362.

46. Blakemore, D. C.; Bryans, J. S.; Carnell, P.; Field, M. J.; Kinsella, N.; Kinsora, J. K.; Meltzer, L. T.; Osborne, S. A.; Thompson, L. R.; Williams, S. C. *Bioorg. Med. Chem. Lett.* **2010**, *20*, 248.
47. Blakemore, D. C.; Bryans, J. S.; Carnell, P.; Carr, C. L.; Chessum, N. E. A.; Field, M. J.; Kinsella, N.; Osborne, S. A.; Warren, A. N.; Williams, S. C. *Bioorg. Med. Chem. Lett.* **2010**, *20*, 461.
48. Felluga, F.; Pitacco, G.; Valentin, E.; Venneri, C. D. *Tetrahedron: Asymmetry* **2008**, *19*, 945.
49. Felluga, F.; Gombac, V.; Pitacco, G.; Valentin, E. *Tetrahedron: Asymmetry* **2004**, *15*, 3323.
50. Belliotti, T. R.; Capiris, T.; Ekható, I. V.; Kinsora, J. J.; Field, M. J.; Heffner, T. G.; Meltzer, L. T.; Schwarz, J. B.; Taylor, C. P.; Thorpe, A. J.; Vartanian, M. G.; Wise, L. D.; Ti, Z.-S.; Weber, M. L.; Wustrow, D. J. *J. Med. Chem.* **2005**, *48*, 2294.
51. Beylin, V.; Boyles, D. C.; Curran, T. T.; Macikenas, D.; Parlett, R. V. I. V.; Vrieze, D. *Org. Process Res. Dev.* **2007**, *11*, 441.
52. Johnson, T. A.; Jang, D. O.; Slafer, B. W.; Curtis, M. D.; Beak, P. *J. Am. Chem. Soc.* **2002**, *124*, 11689.
53. Ji, J.; Barnes, D. M.; Zhang, J.; King, S. A.; Wittenberger, S. J.; Morton, H. E. *J. Am. Chem. Soc.* **1999**, *121*, 10215.
54. Ostroglyadov, E. S.; Vasil'eva, O. S.; Artemova, O. V.; Berestovitskaya, V. M. *Russ. J. Org. Chem.* **2007**, *43*, 1261.
55. Ooi, T.; Fujioka, S.; Maruoka, K. *J. Am. Chem. Soc.* **2004**, *126*, 11790.
56. Siddiquee, T. A.; Lukesh, J. M.; Lindeman, S.; Donaldson, W. A. *J. Org. Chem.* **2007**, *72*, 9802.
57. Mahboobi, S.; Eibler, E.; Koller, M.; Kumar, S. K.; Popp, A.; Schollmeyer, D. *J. Org. Chem.* **1999**, *64*, 4697.
58. Dong, L.; Xu, Y.-J.; Cun, L.-F.; Cui, X.; Mi, A.-Q.; Jiang, Y.-Z.; Gong, L.-Z. *Org. Lett.* **2005**, *7*, 4285.
59. Dong, L.; Xu, Y.-J.; Yuan, W.-C.; Cui, X.; Cun, L.-F.; Gong, L.-Z. *Eur. J. Org. Chem.* **2006**, 4093.
60. Gao, P.; Tong, Z.; Hu, H.; Xu, P.-F.; Liu, W.; Sun, C.; Zhai, H. *Synlett* **2009**, 2188.
61. Pachamuthu, K.; Gupta, A.; Das, J.; Schmidt, R. R.; Vankar, Y. D. *Eur. J. Org. Chem.* **2002**, 1479.
62. Hanessian, S.; Yun, H.; Hou, Y.; Tintelnot-Blomley, M. *J. Org. Chem.* **2005**, *70*, 6746.
63. Otto, A.; Abegaz, B.; Ziemer, B.; Liebscher, J. *Tetrahedron: Asymmetry* **1999**, *10*, 3381.
64. Forzato, C.; Nitti, P.; Pitacco, G.; Valentin, E.; Morganti, S.; Rizzato, E.; Spinelli, D.; Dell'Erba, C.; Petrillo, G.; Tavani, C. *Tetrahedron* **2004**, *60*, 11011.
65. Dixon, D. J.; Ley, S. V.; Rodriguez, F. *Org. Lett.* **2001**, *3*, 3753.
66. Ley, S. V.; Dixon, D. J.; Guy, R. T.; Rodriguez, F.; Sheppard, T. D. *Org. Biomol. Chem.* **2005**, *3*, 4095.
67. Dixon, D. J.; Ley, S. V.; Rodriguez, F. *Angew. Chem. Int. Ed.* **2001**, *40*, 4763.
68. Lubkoll, J.; Wennemers, H. *Angew. Chem. Int. Ed.* **2007**, *46*, 6841.
69. Mulzer, J.; Zuhse, R.; Schmiecken, R. *Angew. Chem. Int. Ed.* **1992**, *31*, 870.
70. Aslanian, R.; Lee, G.; Iyer, R. V.; Shih, N. Y.; Piwinski, J. J.; Draper, R. W.; McPhail, A. T. *Tetrahedron: Asymmetry* **2000**, *11*, 3867.
71. Wu, B.; Kuhen, K.; Ngoc Nguyen, T.; Ellis, D.; Anaclerio, B.; He, X.; Yang, K.; Karanewsky, D.; Yin, H.; Wolff, K.; Bieza, K.; Caldwell, J.; He, Y. *Bioorg. Med. Chem. Lett.* **2006**, *16*, 3430.
72. Brenner, M.; Seebach, D. *Helv. Chim. Acta* **1999**, *82*, 2365.
73. Seebach, D.; Brenner, M.; Rueping, M.; Schweizer, B.; Jaun, B. *Chem. Commun.* **2001**, 207.
74. Seebach, D.; Brenner, M.; Rueping, M.; Jaun, B. *Chem. Eur. J.* **2002**, *8*, 573.
75. Halland, N.; Hazell, R. G.; Jorgensen, K. A. *J. Org. Chem.* **2002**, *67*, 8331.
76. Liu, C.; Lu, Y. *Org. Lett.* **2010**, *12*, 2278.
77. Nakamura, A.; Lectard, S.; Hashizume, D.; Hamashima, Y.; Sodeoka, M. *J. Am. Chem. Soc.* **2010**, *132*, 4036.
78. Xu, Y.; Matsunaga, S.; Shibasaki, M. *Org. Lett.* **2010**, *12*, 3246.
79. Barnes, D. M.; Ji, J.; Fickes, M. G.; Fitzgerald, M. A.; King, S. A.; Morton, H. E.; Plagge, F. A.; Preskill, M.; Wagaw, S. H.; Wittenberger, S. J.; Zhang, J. *J. Am. Chem. Soc.* **2002**, *124*, 13097.
80. Gao, S.; Tu, Y. Q.; Song, Z.; Wang, A.; Fan, X.; Jiang, Y. *J. Org. Chem.* **2005**, *70*, 6523.
81. Xu, R.; Dvoskin, L. P.; Grinevich, V.; Sumithran, S. P.; Crooks, P. A. *Drug Dev. Res.* **2002**, *55*, 173.
82. Dickerson, T. J.; Lovell, T.; Meijler, M. M.; Noodleman, L.; Janda, K. D. *J. Org. Chem.* **2004**, *69*, 6603.

83. Glassco, W.; Suchocki, J.; George, C.; Martin, B. R.; May, E. L. *J. Med. Chem.* **1993**, *36*, 3381.
84. Chavdarian, C. G.; Seeman, J. I.; Wooten, J. B. *J. Org. Chem.* **1983**, *48*, 492.
85. Tang, M.; Fan, C.-A.; Zhang, F.-M.; Tu, Y.-Q. *Tetrahedron* **2009**, *65*, 5716.
86. Kenda, B. M.; Matagne, A. C.; Talaga, P. E.; Pasau, P. M.; Differding, E.; Lallemand, B. I.; Frycia, A. M.; Moureau, F. G.; Klitgaard, H. V.; Gillard, M. R.; Fuks, B.; Michel, P. *J. Med. Chem.* **2004**, *47*, 530.
87. Hanessian, S.; Seid, M.; Nilsson, I. *Tetrahedron Lett.* **2002**, *43*, 1991.
88. Aszodi, J.; Rowlands, D. A.; Mauvais, P.; Collette, P.; Bonnefoy, A.; Lampilas, M. *Bioorg. Med. Chem. Lett.* **2004**, *14*, 2489.
89. Blay, G.; Hernandez-Olmos, V.; Pedro, J. R. *Org. Lett.* **2010**, *12*, 3058.
90. Palomo, C.; Landa, A.; Mielgo, A.; Oiarbide, M.; Puente, A.; Vera, S. *Angew. Chem. Int. Ed.* **2007**, *46*, 8431.
91. Vakulya, B.; Varga, S.; Soos, T. *J. Org. Chem.* **2008**, *73*, 3475.
92. Filichev, V. V.; Brandt, M.; Pedersen, E. B. *Carbohydr. Res.* **2001**, *333*, 115.
93. Wuitschik, G.; Rogers-Evans, M.; Buckl, A.; Bernasconi, M.; Marki, M.; Godel, T.; Fischer, H.; Wagner, B.; Parrilla, I.; Schuler, F.; Schneider, J.; Alker, A.; Schweizer, W. B.; Muller, K.; Carreira, E. M. *Angew. Chem. Int. Ed.* **2008**, *47*, 4512.
94. Trost, B. M.; Hisaindee, S. *Org. Lett.* **2006**, *8*, 6003.
95. García-García, P.; Ladépêche, A.; Halder, R.; List, B. *Angew. Chem. Int. Ed.* **2008**, *47*, 4719.
96. Betancort, J. M.; Sakthivel, K.; Thayumanavan, R.; Tanaka, F.; Barbas, C. F., III *Synthesis* **2004**, 1509.
97. Zhu, S.; Yu, S.; Ma, D. *Angew. Chem. Int. Ed.* **2008**, *47*, 545.
98. Wang, J.; Li, H.; Lou, B.; Zu, L.; Guo, H.; Wang, W. *Chem. Eur. J.* **2006**, *12*, 4321.
99. Micheletti, G.; Pollicino, S.; Ricci, A.; Berionni, G.; Cahiez, G. *Synlett* **2007**, 2829.
100. Belot, S.; Sulzer-Mosse, S.; Kehrl, S.; Alexakis, A. *Chem. Commun.* **2008**, 4694.
101. Ibrahim, I.; Zou, W.; Xu, Y.; Cordova, A. *Adv. Synth. Catal.* **2006**, *348*, 211.
102. Karthikeyan, T.; Sankararaman, S. *Tetrahedron: Asymmetry* **2008**, *19*, 2741.
103. Cao, C.-L.; Ye, M.-C.; Sun, X.-L.; Tang, Y. *Org. Lett.* **2006**, *8*, 2901.
104. Keller, E.; Feringa, B. L. *Synlett* **1997**, 842.
105. Duvall, J. R.; Wu, F.; Snider, B. B. *J. Org. Chem.* **2006**, *71*, 8579.
106. Moglioni, A. G.; Brousse, B. N.; Alvarez-Larena, A.; Moltrasio, G. Y.; Ortuno, R. M. *Tetrahedron: Asymmetry* **2002**, *13*, 451.
107. Izquierdo, S.; Aguilera, J.; Buschmann, H. H.; Garcia, M.; Torrens, A.; Ortuno, R. M. *Tetrahedron: Asymmetry* **2008**, *19*, 651.
108. Aguilera, J.; Gutierrez-Abad, R.; Mor, A.; Moglioni, A. G.; Moltrasio, G. Y.; Ortuno, R. M. *Tetrahedron: Asymmetry* **2008**, *19*, 2864.
109. Domingos, J. L. O.; Lima, E. C.; Dias, A. G.; Costa, P. R. R. *Tetrahedron: Asymmetry* **2004**, *15*, 2313.
110. Seitzberg, J. G.; Knapp, A. E.; Lund, B. W.; Mandrup Bertozzi, S.; Currier, E. A.; Ma, J.-N.; Sherbukhin, V.; Burstein, E. S.; Olsson, R. *J. Med. Chem.* **2008**, *51*, 5490.
111. Blaszczyk, E.; Krawczyk, H.; Janecki, T. *Synlett* **2004**, 2685.
112. Janecki, T.; Blaszczyk, E.; Studzian, K.; Janecka, A.; Krajewska, U.; Rozalski, M. *J. Med. Chem.* **2005**, *48*, 3516.
113. Maeda, H.; Selvakumar, N.; Kraus, G. A. *Tetrahedron* **1999**, *55*, 943.
114. Rahaim, R. J., Jr.; Maleczka, R. E., Jr. *Org. Lett.* **2005**, *7*, 5087.
115. Rahaim, R. J., Jr.; Maleczka, R. E., Jr. *Synthesis* **2006**, 3316.
116. Corey, E. J.; Zhang, F.-Y. *Org. Lett.* **2000**, *2*, 4257.
117. Camps, P.; Munoz-Torrero, D.; Sanchez, L. *Tetrahedron: Asymmetry* **2004**, *15*, 2039.
118. Okino, T.; Hoashi, Y.; Furukawa, T.; Xu, X.; Takemoto, Y. *J. Am. Chem. Soc.* **2005**, *127*, 119.
119. Oliveira, A. R. M.; Villar, J. A. F. P.; Simonelli, F.; Gariani, R. A.; Wosch, C. L.; Zarbin, P. H. G. *Tetrahedron Lett.* **2007**, *48*, 1507.
120. Hynes, P. S.; Stupple, P. A.; Dixon, D. J. *Org. Lett.* **2008**, *10*, 1389.
121. Zeng, W.; Miao, W.; Kabalka, G.; Le Puil, M.; Biggerstaff, J.; Townsend, D. *Tetrahedron Lett.* **2008**, *49*, 6429.

122. Zeng, W.; Miao, W.; Le Puil, M.; Shi, G.; Biggerstaff, J.; Kabalka, G. W.; Townsend, D. *Biochem. Biophys. Res. Commun.* **2010**, *398*, 571.
123. Evans, D. A.; Mito, S.; Seidel, D. *J. Am. Chem. Soc.* **2007**, *129*, 11583.
124. Krawczyk, H.; Albrecht, L.; Wojciechowski, J.; Wolf, W. M.; Krajewska, U.; Rozalski, M. *Tetrahedron* **2008**, *64*, 6307.
125. Albrecht, A.; Albrecht, L.; Rozalski, M.; Krajewska, U.; Janecka, A.; Studzian, K.; Janecki, T. *New J. Chem.* **2010**, *34*, 750.
126. Huang, Y.; Li, Q.; Liu, T.-L.; Xu, P.-F. *J. Org. Chem.* **2009**, *74*, 1252.
127. Yasuhara, T.; Nishimura, K.; Yamashita, M.; Fukuyama, N.; Yamada, K.; Muraoka, O.; Tomioka, K. *Org. Lett.* **2003**, *5*, 1123.
128. Yasuhara, T.; Osafune, E.; Nishimura, K.; Yamashita, M.; Yamada, K.-I.; Muraoka, O.; Tomioka, K. *Tetrahedron Lett.* **2004**, *45*, 3043.
129. Photiadou, A. D.; Stathakis, C. I.; Gallos, J. K. *J. Heterocycl. Chem.* **2008**, *45*, 1251.
130. Chen, Y.; Zhong, C.; Sun, X.; Akhmedov, N. G.; Petersen, J. L.; Shi, X. *Chem. Commun.* **2009**, 5150.
131. Roller, S.; Siegers, C.; Haag, R. *Tetrahedron* **2004**, *60*, 8711.
132. Crosignani, S.; Page, P.; Missotten, M.; Colovray, V.; Cleva, C.; Arrighi, J.-F.; Atherall, J.; Macritchie, J.; Martin, T.; Humbert, Y.; Gaudet, M.; Pupowicz, D.; Maio, M.; Pittet, P.-A.; Golzio, L.; Giachetti, C.; Rocha, C.; Bernardinelli, G.; Filinchuk, Y.; Scheer, A.; Schwarz, M. K.; Chollet, A. *J. Med. Chem.* **2008**, *51*, 2227.
133. Ruiz, N.; Reyes, E.; Vicario, J. L.; Badia, D.; Carrillo, L.; Uria, U. *Chem. Eur. J.* **2008**, *14*, 9357.
134. Zou, W.; Wu, A.-T.; Bhasin, M.; Sandbhor, M.; Wu, S.-H. *J. Org. Chem.* **2007**, *72*, 2686.
135. Jiang, X.; Zhang, Y.; Chan, A. S. C.; Wang, R. *Org. Lett.* **2009**, *11*, 153.
136. Ma, H.; Liu, K.; Zhang, F.-G.; Zhu, C.-L.; Nie, J.; Ma, J.-A. *J. Org. Chem.* **2010**, *75*, 1402.
137. Han, B.; Xiao, Y.-C.; He, Z.-Q.; Chen, Y.-C. *Org. Lett.* **2009**, *11*, 4660.
138. Zhong, C.; Chen, Y.; Petersen, L.; Akhmedov, N. G.; Shi, X. *Angew. Chem. Int. Ed.* **2009**, *48*, 1279.
139. Kim, H.-J.; Dogutan, D. K.; Ptaszek, M.; Lindsey, J. S. *Tetrahedron* **2007**, *63*, 37.
140. Ningsanont, N.; Black, D. S. C.; Chanphen, R.; Thebtaranonth, Y. *J. Med. Chem.* **2003**, *46*, 2397.
141. Black, D. S. C.; Craig, D. C.; Edwards, G. L.; Laaman, S. M. *Tetrahedron Lett.* **1998**, *39*, 5849.
142. Laha, J. K.; Muthiah, C.; Taniguchi, M.; McDowell, B. E.; Ptaszek, M.; Lindsey, J. S. *J. Org. Chem.* **2006**, *71*, 4092.
143. Nieves-Bernier, E. J.; Diers, J. R.; Taniguchi, M.; Holten, D.; Bocian, D. F.; Lindsey, J. S. *J. Org. Chem.* **2010**, *75*, 3193.
144. Ptaszek, M.; Bhaumik, J.; Kim, H.-J.; Taniguchi, M.; Lindsey, J. S. *Org. Process Res. Dev.* **2005**, *9*, 651.
145. Taniguchi, M.; Ra, D.; Mo, G.; Balasubramanian, T.; Lindsey, J. S. *J. Org. Chem.* **2001**, *66*, 7342.
146. Taniguchi, M.; Kim, H.-J.; Ra, D.; Schwartz, J. K.; Kirmaier, C.; Hindin, E.; Diers, J. R.; Prathapan, S.; Bocian, D. F.; Holten, D.; Lindsey, J. S. *J. Org. Chem.* **2002**, *67*, 7329.
147. Uchida, Y.; Matsuoka, N.; Takahashi, H.; Shimono, S.; Ikuma, N.; Tamura, R. *Heterocycles* **2007**, *74*, 607.
148. Hirayama, T.; Taki, M.; Nakamura, M.; Arata, T.; Yamamoto, Y. *Chem. Lett.* **2006**, *35*, 834.
149. Ma, L.-J.; Li, X.-X.; Kusuyama, T.; El-Sayed, I. E.-T.; Inokuchi, T. *J. Org. Chem.* **2009**, *74*, 9218.
150. Pansare, S. V.; Lingampally, R.; Kirby, R. L. *Org. Lett.* **2010**, *12*, 556.
151. García Mancheño, O.; Tangen, P.; Rohlmann, R.; Frohlich, R.; Aleman, J. *Chem. Eur. J.* **2011**, *17*, 984.
152. Stolze, K.; Udilova, N.; Rosenau, T.; Hofinger, A.; Nohl, H. *Biol. Chem.* **2003**, *384*, 493.
153. Stolze, K.; Udilova, N.; Rosenau, T.; Hofinger, A.; Nohl, H. *Biochem. Pharmacol.* **2005**, *69*, 297.
154. Karoui, H.; Clement, J.-L.; Rockenbauer, A.; Siri, D.; Tordo, P. *Tetrahedron Lett.* **2004**, *45*, 149.
155. Bardelang, D.; Rockenbauer, A.; Karoui, H.; Finet, J.-P.; Biskupska, I.; Banaszak, K.; Tordo, P. *Org. Biomol. Chem.* **2006**, *4*, 2874.
156. Stolze, K.; Rohr-Udilova, N.; Hofinger, A.; Rosenau, T. *Bioorg. Med. Chem.* **2008**, *16*, 8082.
157. Stolze, K.; Rohr-Udilova, N.; Hofinger, A.; Rosenau, T. *Bioorg. Med. Chem.* **2009**, *17*, 7572.
158. Stolze, K.; Rohr-Udilova, N.; Rosenau, T.; Hofinger, A.; Kolarich, D.; Nohl, H. *Bioorg. Med. Chem.* **2006**, *14*, 3368.

159. Clement, J.-L.; Finet, J.-P.; Frejaville, C.; Tordo, P. *Org. Biomol. Chem.* **2003**, *1*, 1591.
160. Basavaiah, D.; Rao, J. S. *Tetrahedron Lett.* **2004**, *45*, 1621.
161. Lee, M. J.; Lee, K. Y.; Park, D. Y.; Kim, J. N. *Bull. Korean Chem. Soc.* **2005**, *26*, 1281.
162. Lee, H. S.; Kim, S. J.; Kim, J. N. *Bull. Korean Chem. Soc.* **2006**, *27*, 1063.
163. Knobloch, K.; Koch, J.; Keller, M.; Eberbach, W. *Eur. J. Org. Chem.* **2005**, 2715.
164. Strachan, J.-P.; O'Shea, D. F.; Balasubramanian, T.; Lindsey, J. S. *J. Org. Chem.* **2000**, *65*, 3160.
165. Balasubramanian, T.; Strachan, J.-P.; Boyle, P. D.; Lindsey, J. S. *J. Org. Chem.* **2000**, *65*, 7919.
166. Kim, H.-J.; Lindsey, J. S. *J. Org. Chem.* **2005**, *70*, 5475.
167. Taniguchi, M.; Cramer, D. L.; Bhise, A. D.; Kee, H. L.; Bocian, D. F.; Holten, D.; Lindsey, J. S. *New J. Chem.* **2008**, *32*, 947.
168. Borbas, K. E.; Ruzie, C.; Lindsey, J. S. *Org. Lett.* **2008**, *10*, 1931.
169. Krayner, M.; Ptaszek, M.; Kim, H.-J.; Meneely, K. R.; Fan, D.; Secor, K.; Lindsey, J. S. *J. Org. Chem.* **2010**, *75*, 1016.
170. Roberts, L. R.; Fish, P. V.; Ian Storer, R.; Whitlock, G. A. *Bioorg. Med. Chem. Lett.* **2009**, *19*, 3113.
171. Sammis, G. M.; Jacobsen, E. N. *J. Am. Chem. Soc.* **2003**, *125*, 4442.
172. Mita, T.; Sasaki, K.; Kanai, M.; Shibasaki, M. *J. Am. Chem. Soc.* **2005**, *127*, 514.
173. Fujimori, I.; Mita, T.; Maki, K.; Shiro, M.; Sato, A.; Furusho, S.; Kanaia, M.; Shibasaki, M. *Tetrahedron* **2007**, *63*, 5820.
174. Bernardi, L.; Fini, F.; Fochi, M.; Ricci, A. *Synlett* **2008**, 1857.
175. Madhavan, N.; Weck, M. *Adv. Synth. Catal.* **2008**, *350*, 419.
176. Mazet, C.; Jacobsen, E. N. *Angew. Chem. Int. Ed.* **2008**, *47*, 1762.
177. Tanaka, Y.; Kanai, M.; Shibasaki, M. *J. Am. Chem. Soc.* **2008**, *130*, 6072.
178. Laronze, M.; Boisbrun, M.; Leonce, S.; Pfeiffer, B.; Renard, P.; Lozach, O.; Meijer, L.; Lansiaux, A.; Bailly, C.; Sapi, J.; Laronze, J. Y. *Bioorg. Med. Chem.* **2005**, *13*, 2263.
179. Tao, M.; Park, C. H.; Bihovsky, R.; Wells, G. J.; Husten, J.; Ator, M. A.; Hudkins, R. L. *Bioorg. Med. Chem. Lett.* **2006**, *16*, 938.
180. Wells, G. J.; Bihovsky, R.; Hudkins, R. L.; Ator, M. A.; Husten, J. *Bioorg. Med. Chem. Lett.* **2006**, *16*, 1151.
181. Hudkins, R. L.; Johnson, N. W.; Angeles, T. S.; Gessner, G. W.; Mallamo, J. P. *J. Med. Chem.* **2007**, *50*, 433.
182. Conchon, E.; Anizon, F.; Aboab, B.; Golsteyn, R. M.; Leonce, S.; Pfeiffer, B.; Prudhomme, M. *Bioorg. Med. Chem.* **2008**, *16*, 4419.
183. Hudkins, R. L.; Diebold, J. L.; Tao, M.; Josef, K. A.; Park, C. H.; Angeles, T. S.; Aimone, L. D.; Husten, J.; Ator, M. A.; Meyer, S. L.; Holskin, B. P.; Durkin, J. T.; Fedorov, A. A.; Fedorov, E. V.; Almo, S. C.; Mathiasen, J. R.; Bozyczko-Coyne, D.; Saporito, M. S.; Scott, R. W.; Mallamo, J. P. *J. Med. Chem.* **2008**, *51*, 5680.
184. Tao, M.; Park, C. H.; Josef, K.; Hudkins, R. L. *J. Heterocycl. Chem.* **2009**, *46*, 1185.
185. Kazmierski, W. M.; Aquino, C.; Chauder, B. A.; Deanda, F.; Ferris, R.; Jones-Hertzog, D. K.; Kenakin, T.; Koble, C. S.; Watson, C.; Wheelan, P.; Yang, H.; Youngman, M. *J. Med. Chem.* **2008**, *51*, 6538.
186. Lemoine, R. C.; Petersen, A. C.; Setti, L.; Wanner, J.; Jekle, A.; Heilek, G.; deRosier, A.; Ji, C.; Berry, P.; Rotstein, D. *Bioorg. Med. Chem. Lett.* **2010**, *20*, 704.
187. Wang, J.; Li, W.; Liu, Y.; Chu, Y.; Lin, L.; Liu, X.; Feng, X. *Org. Lett.* **2010**, *12*, 1280.
188. Aguirre, D.; Cativiela, C.; Diaz-de-Villegas, M. D.; Galvez, J. A. *Tetrahedron* **2006**, *62*, 8142.
189. Martinez, C. A.; Hu, S.; Dumond, Y.; Tao, J.; Kelleher, P.; Tully, L. *Org. Process Res. Dev.* **2008**, *12*, 392.
190. Bolognesi, M. L.; Bartolini, M.; Cavalli, A.; Andrisano, V.; Rosini, M.; Minarini, A.; Melchiorre, C. *J. Med. Chem.* **2004**, *47*, 5945.
191. Hara, O.; Sugimoto, K.; Makino, K.; Hamada, Y. *Synlett* **2004**, 1625.
192. Hara, O.; Sugimoto, K.; Hamada, Y. *Tetrahedron* **2004**, *60*, 9381.
193. Yoshitomi, Y.; Arai, H.; Makino, K.; Hamada, Y. *Tetrahedron* **2008**, *64*, 11568.
194. Armstrong, A.; Convine, N. J.; Popkin, M. E. *Synlett* **2006**, 1589.

195. Tian, Q.; Nayyar, N. K.; Babu, S.; Chen, L.; Tao, J.; Lee, S.; Tibbetts, A.; Moran, T.; Liou, J.; Guo, M.; Kennedy, T. P. *Tetrahedron Lett.* **2001**, *42*, 6807.
196. Ghosh, A. K.; Xi, K.; Ratia, K.; Santarsiero, B. D.; Fu, W.; Harcourt, B. H.; Rota, P. A.; Baker, S. C.; Johnson, M. E.; Mesecar, A. D. *J. Med. Chem.* **2005**, *48*, 6767.
197. Jain, R. P.; Vederas, J. C. *Bioorg. Med. Chem. Lett.* **2004**, *14*, 3655.
198. Yang, S.; Chen, S.-J.; Hsu, M.-F.; Wu, J.-D.; Tseng, C.-T. K.; Liu, Y.-F.; Chen, H.-C.; Kuo, C.-W.; Wu, C.-S.; Chang, L.-W.; Chen, W.-C.; Liao, S.-Y.; Chang, T.-Y.; Hung, H.-H.; Shr, H.-L.; Liu, C.-Y.; Huang, Y.-A.; Chang, L.-Y.; Hsu, J.-C.; Peters, C. J.; Wang, A. H. J.; Hsu, M.-C. *J. Med. Chem.* **2006**, *49*, 4971.
199. Peddi, S.; Roth, B. L.; Glennon, R. A.; Westkaemper, R. B. *Bioorg. Med. Chem. Lett.* **2004**, *14*, 2279.
200. Macdonald, S. J. F.; Clarke, G. D. E.; Dowle, M. D.; Harrison, L. A.; Hodgson, S. T.; Inglis, G. G. A.; Johnson, M. R.; Shah, P.; Upton, R. J.; Walls, S. B. *J. Org. Chem.* **1999**, *64*, 5166.
201. Thakur, V. V.; Nikalje, M. D.; Sudalai, A. *Tetrahedron: Asymmetry* **2003**, *14*, 581.
202. Burton, A. J.; Wadsworth, A. H. *J. Labelled Compd. Radiopharm.* **2007**, *50*, 273.
203. Hirata, Y.; Yada, A.; Morita, E.; Nakao, Y.; Hiyama, T.; Ohashi, M.; Ogoshi, S. *J. Am. Chem. Soc.* **2010**, *132*, 10070.
204. Giardina, A.; Marcantoni, E.; Mecozzi, T.; Petrini, M. *Eur. J. Org. Chem.* **2001**, 713.
205. Nakao, Y.; Hirata, Y.; Hiyama, T. *J. Am. Chem. Soc.* **2006**, *128*, 7420.
206. Hirata, Y.; Inui, T.; Nakao, Y.; Hiyama, T. *J. Am. Chem. Soc.* **2009**, *131*, 6624.
207. Gemma, S.; Campiani, G.; Butini, S.; Morelli, E.; Minetti, P.; Tinti, O.; Nacci, V. *Tetrahedron* **2002**, *58*, 3689.
208. Mou, K.; Xu, B.; Ma, C.; Yang, X.; Zou, X.; Yang, L.; Xu, P. *Bioorg. Med. Chem. Lett.* **2008**, *18*, 2198.
209. Suarez-Castillo, O. R.; Sanchez-Zavala, M.; Melendez-Rodriguez, M.; Castelan-Duarte, L. E.; Morales-Rios, M. S.; Joseph-Nathan, P. *Tetrahedron* **2006**, *62*, 3040.
210. Rivera-Becerril, E.; Joseph-Nathan, P.; Perez-Alvarez, V. M.; Morales-Rios, M. S. *J. Med. Chem.* **2008**, *51*, 5271.
211. Muratake, H.; Natsume, M.; Nakai, H. *Tetrahedron* **2006**, *62*, 7093.

PALLADIUM-CATALYZED AMINATION REACTION IN THE SYNTHESIS OF NITROGEN- AND OXYGEN-CONTAINING MACROCYCLES AND MACROPOLYCYCLES

Alexei D. Averin,^a Sergei M. Kobelev,^a Maksim V. Anokhin,^a Alla G. Bessmertnykh Lemeune,^b Roger Guillard^b and Irina P. Beletskaya*^a

^aLomonosov Moscow State University, Department of Chemistry, Leninskie Gory, Moscow, Ru-119991, Russia (e-mail: beletska@org.chem.msu.ru)

^bInstitut de Chimie Moléculaire de l'Université de Bourgogne (ICMUB) UMR CNRS 5260, 9 av. Alain Savary, F-21078 Dijon, France (e-mail: rguillard@u-bourgogne.fr)

Abstract. Palladium-catalyzed amination of aromatic dihalides with linear polyamines and polyoxadiazines was thoroughly investigated and proved to be a versatile and efficient synthetic approach to nitrogen- and oxygen-containing macrocycles comprising aryl moieties. The following aryl halides were examined: 1,2- and 1,3-dibromobenzenes, 1,3-dichloro-2-bromobenzene, 2,6- and 3,5-dibromopyridines, 3,3'- and 4,4'-dibromobiphenyls, 2,7-dibromonaphthalene, 6,6'-dibromo-2,2'-bipyridine, 1,8- and 1,5-dichloroanthracenes, 1,8- and 1,5-dichloroanthraquinones. More sophisticated compounds bearing haloaryl moieties such as bis(halobenzyl) derivatives of cholandediol, cyclen, cyclam, aza- and diazacrown ethers can be also employed for the synthesis of macrobicyclic and macropolycyclic compounds. The regularities of the macrocyclization reactions, formation of by-products and the dependence of the reaction results on the nature of starting compounds were investigated.

Contents

1. Introduction
2. Macrocycles comprising aryl moieties
 - 2.1. Macrocycles based on 1,2- and 1,3-disubstituted benzenes
 - 2.2. Macrocycles with biphenyl units
 - 2.3. Naphthalene-based macrocycles
 - 2.4. Macrocycles comprising anthracene and anthraquinone fragments
3. Macrocycles containing heteroaryl moieties
 - 3.1. Pyridine-based macrocycles
 - 3.2. 2,2'-Bipyridine-containing macrocycles
 - 3.3. Macrocycles with pyrimidine units
4. Macrocycles incorporating adamantane fragment
5. Macrocyclic derivatives of cholandediol
6. Macropolycyclic compounds
 - 6.1. Macrobi- and macrotricycles derived from substituted cyclen and cyclam
 - 6.2. Macropolycyclic derivatives of azacrown ethers
 - 6.3. Macrobicycles based on disubstituted biphenyl and naphthalene
7. Applications of the macrocycles for metal ions detection
8. Conclusions

Acknowledgments

References

1. Introduction

At present time, there is a great need for a rational design of ligands aimed to selective complexation of metal ions, anions and polar organic molecules. Currently these compounds are of substantial interest for an impressive range of useful applications including the development of metal ion sequestration agents in detergents, selective metal extractants in hydrometallurgy and nuclear industry, *in vivo* imaging agents, pharmaceuticals, cation transport systems, pollution sensors. During last decades hundreds of such ligands were synthesized, which contain nitrogen, oxygen, sulfur, phosphorous donor atoms.¹⁻⁴ Both the nature of donor atoms and the ligand architecture influence the complexing properties of such molecules. Macrocyclic chelators are of special interest due to a high stability of corresponding metal complexes in the case when the size of the cation matches the size of the macrocycle. These particular ligands are widely used nowadays; however, their synthesis is complicated and quite often laborious multistep routes result in rather low yields of the target products.⁵⁻¹⁹ Sophisticated technological demands explain a constant interest paid to new synthetic approaches to these sophisticated molecules. The amination of aryl halides developed by Buchwald and Hartwig in 1990s is a powerful method for aromatic amines synthesis. The currently accepted mechanism of this reaction is presented on Figure 1,²⁰⁻²² and includes the following steps: (a) formation of the active catalytic species, (b) oxidative addition of the aryl halide, (c) coordination of the amine, (d) deprotonation of the coordinated amine group, and (e) reductive elimination of the product. In spite of the fact that detailed mechanistic studies were undertaken,²³⁻³¹ a lot of experimental data are yet not entirely clear showing that the reaction is more complex than this general mechanistic scheme depicts.

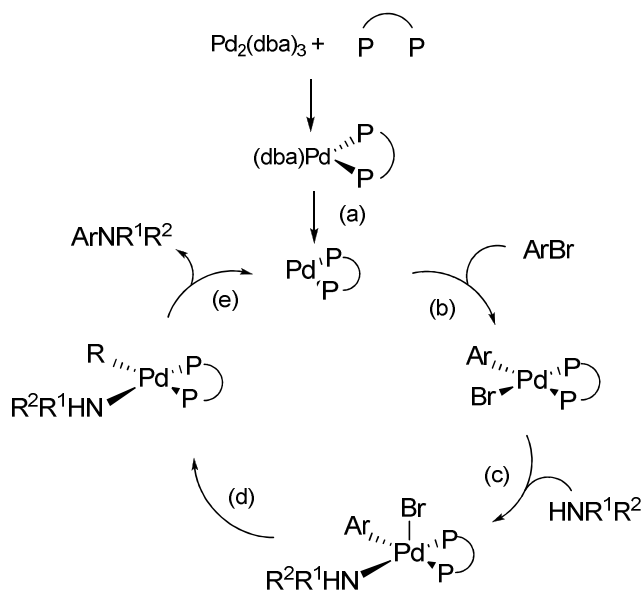
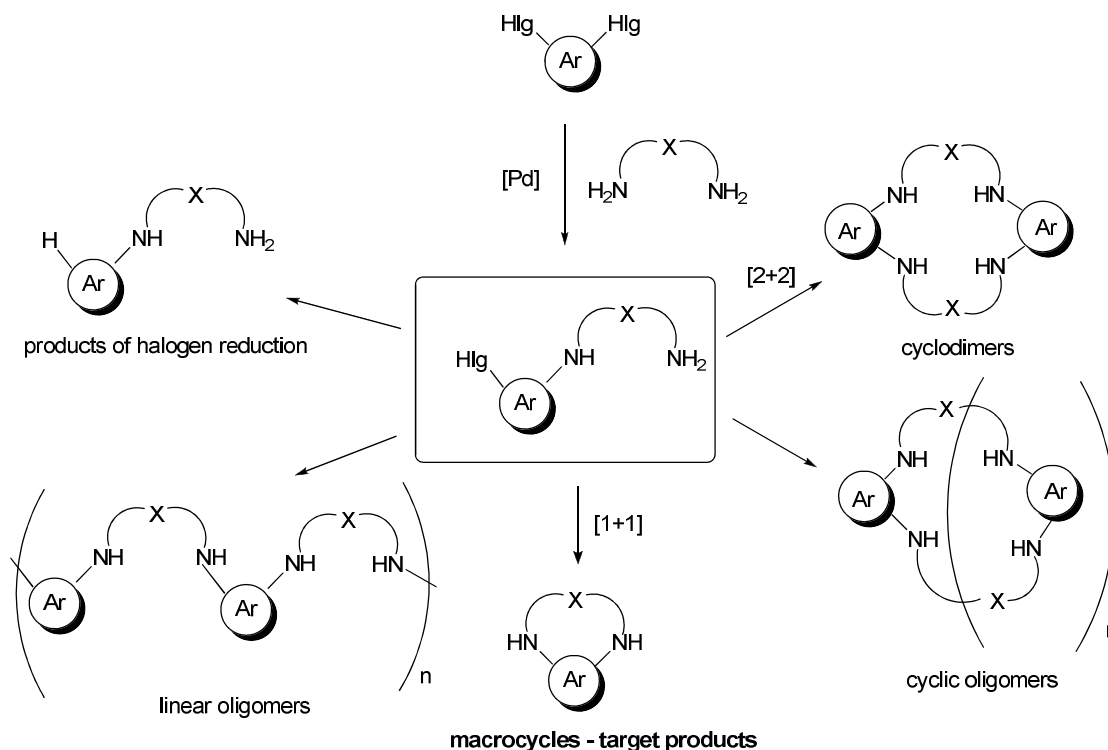

Figure 1

The Buchwald-Hartwig amination reaction is a very promising method to introduce an aromatic moiety within the macrocyclic ligand. Aromatic fragments are known to change rigidity and solubility of organic molecules. Moreover, aromatic moieties are often used as signaling subunits in chemosensors.³²⁻⁴³

In the majority of cases aromatic groups in such molecules are separated from the donor atoms at least by one methylene or methine group.^{44–51} Indeed, the introduction of C(sp²)-heteroatom bond in the macrocyclic ring is difficult by common synthetic approaches, therefore we supposed that Pd-catalyzed methodology could be useful in the synthesis of original macrocyclic molecules. Previously we have demonstrated the utility of the Pd-catalyzed amination of aryl halides in the synthesis of *N*-aryl substituted polyamines.^{52–54}

Catalytic systems were adjusted and optimized for selective mono-, di- and polyarylation of polyamines. The most important result of these investigations was the demonstration of the possibility to carry out selective arylation of primary amino groups in the presence of secondary amino groups. This feature is useful in the synthesis of polyazamacrocycles as it will be shown throughout this review.



To synthesize a macrocycle containing an aromatic group in the cycle, two successive aminations of aromatic aryl dihalide with a linear polyamine should be carried out (Scheme 1). The second step of this process is intramolecular and at first glance it seems to be easily realized. In reality, the cyclization reaction competes with the formation of cyclic and linear oligomers formation and reduction of the resting halogen atom (hydrodebromination reaction). By changing the nature of starting compounds, catalytic system and reaction conditions, we have shown how to manage this process and achieve good yields of the desired macrocycles.

Moreover, cyclic dimers forming by the reaction of two molecules of aryl dihalide and two amine molecules (cyclodimers) are interesting macrocyclic chelators. Two alternative synthetic approaches were studied to optimize their synthesis (Scheme 2). The first method (A) includes the formation of intermediate *N,N'*-bis(bromoaryl) substituted polyamine which is used either *in situ* or after purification by column chromatography. The second one (B) employs bis(polyamine) substituted arenes which are always used *in situ*.

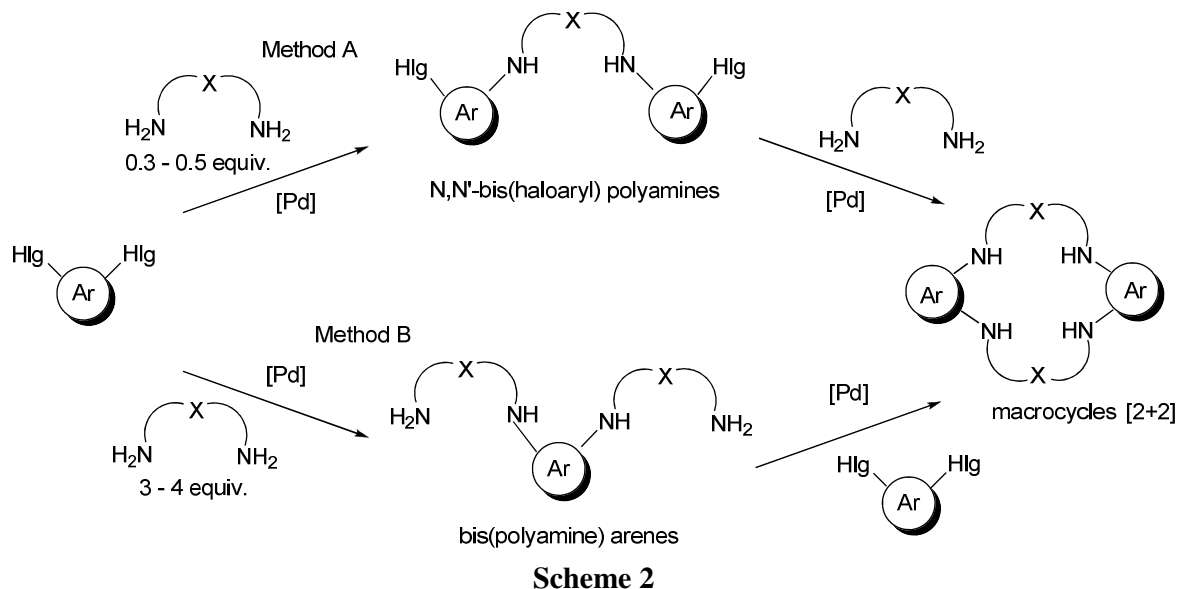

The aim of this review is to give an overview of the synthesis of macrocycles by the Pd-catalyzed amination reaction and to compare the reactivity of different aromatic dihalides and di- and polyamines.

2. Macrocycles comprising aryl moieties

2.1. Macrocycles based on 1,2- and 1,3-disubstituted benzenes

First we studied the simplest dihaloarene – 1,2-dibromobenzene (**1**) in the reactions with tetraamine **2a** and trioxadamine **2b**, in order to obtain macrocycles containing *ortho*-disubstituted benzene in the macrocyclic ring.^{55,56} We used equimolar amounts of starting compounds, the standard catalytic system Pd(dba)₂/BINAP (8/9 mol%) (dba=dibenzylideneacetone, BINAP=2,2'-bis(diphenylphosphino)-1,1'-binaphthalene) and sodium *tert*-butoxide as a base. The reactions were run in dilute (c=0.02 M) dioxane solutions to suppress the formation of linear oligomers. However, *ortho*-dibromobenzene turned to be enough reluctant in the diamination process as the reaction with tetraamine **2a** provided only 12% yield of the desired macrocycle **3a** (Scheme 3) after refluxing for 70 hours. The reaction with trioxadamine **2b** was even more difficult. Pd(dba)₂/BINAP system was inefficient and target macrocycle **3b** was synthesized in 14%* yield only when employing donor phosphine ligand 2-dimethylamino-2'-dicyclohexylphosphino-1,1'-biphenyl (DavePHOS).

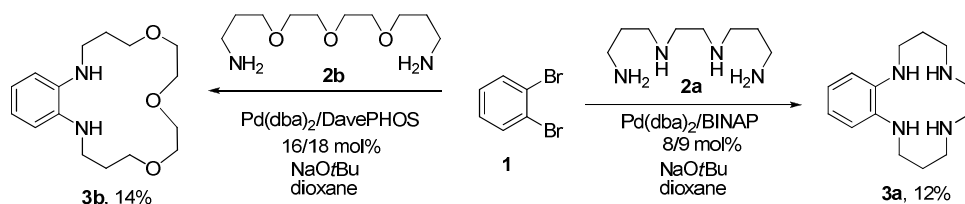

Scheme 3

Thus, the substitution of the bromine in the monoaminated intermediate is severely hindered by the amino group in *ortho*-position. To increase the reactivity of aryl halide, we used a compound bearing an

* Here and throughout the text, the yields of macrocycles after their isolation by column chromatography on silica gel are given.

additional halogen atom, namely 2,6-dichlorobromobenzene (**4**), which was reacted with a variety of di- and polyamines **2a–k** (Fig. 2).

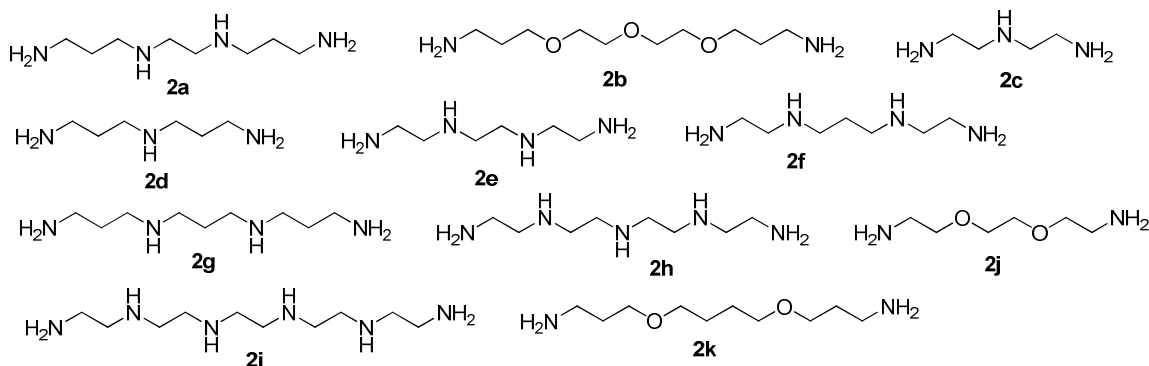
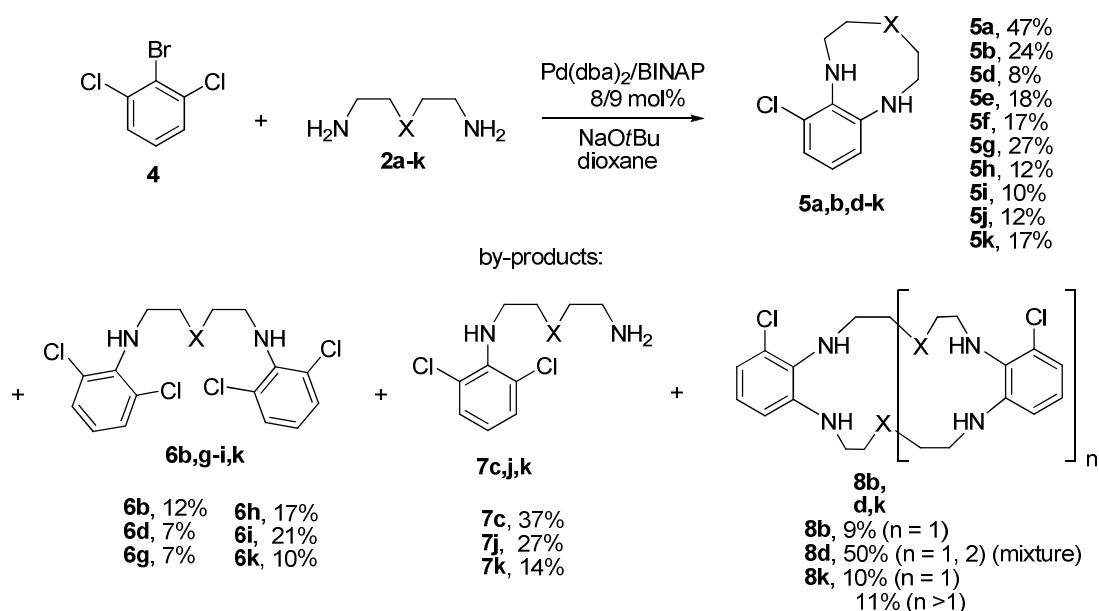

Figure 2

Target macrocycles **5a,b,d–k**[†] were obtained in 8–47% yields after refluxing for 24–30 h (Scheme 4). Open-chain and cyclic compounds **6–8** were observed as by-products in all studied reactions. As expected, the best results were achieved with long-chain di- and polyamines **2a,b,g**. However, we did not observe any dependence of the number of nitrogen atoms on the yields of polyazamacrocycles **5**.



Scheme 4

To synthesize the cyclic dimers **8** which are of interest due to a larger cavity size, we elaborated their synthesis *via* *N,N'*-di(dichlorophenyl)polyamines **6** obtained from 2.2 equiv. of dichlorobromobenzene **4** and 1 equiv. of corresponding polyamine **2** (Schemes 2 and 5). As the compounds **6** were obtained in 85–90% yields, they were used *in situ* with the second molecule of polyamine **2** catalyzed with 16 mol% catalyst. Cyclodimers **8** were isolated in quite reasonable yields of 20–30%.

[†] Here and throughout the text, letters in the product names correspond to the letters in the names of the linear polyamine **2** participating in the reactions (Figure 2).

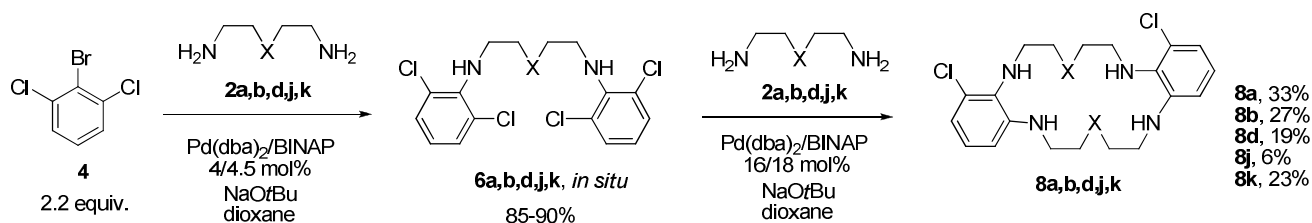

Scheme 5

1,3-Dibromobenzene (**9**) was thought to be more suitable for the macrocycle synthesis due to the fact that the substitution of the first bromine atom for amino group would not significantly affect the substitution of the second bromine atom. The reactions with polyamines **2a–h,j,k** were run in the presence of Pd(dba)₂/BINAP catalytic system (Scheme 6)⁵⁷ and the yields of target macrocycles **10** were found to be strongly dependent on the length of the starting polyamines. For example, triamine **2c** (7 atoms in the chain) did not provide the corresponding cycle, triamine **2d** with 9 atoms in the chain afforded target compound **10d** in a low yield (15%) and longer tetraamines **2a,e–g**, pentaamine **2h** and oxadiazines **2a,j,k** gave the target macrocycles in moderate to good yields. Here again cyclodimers **11** were formed as by-products but they could not be isolated in pure state.

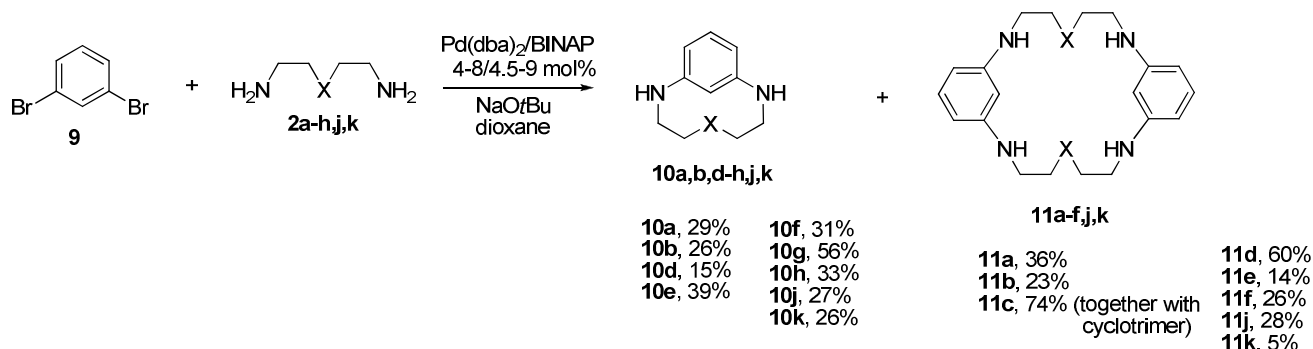

Scheme 6

The synthesis of cyclodimers **11** was more efficient using method A *via* diarylated compounds **12** (Scheme 7). These compounds were obtained in 70–80% yields in the reaction mixtures and isolated by column chromatography in 29–64% yields.

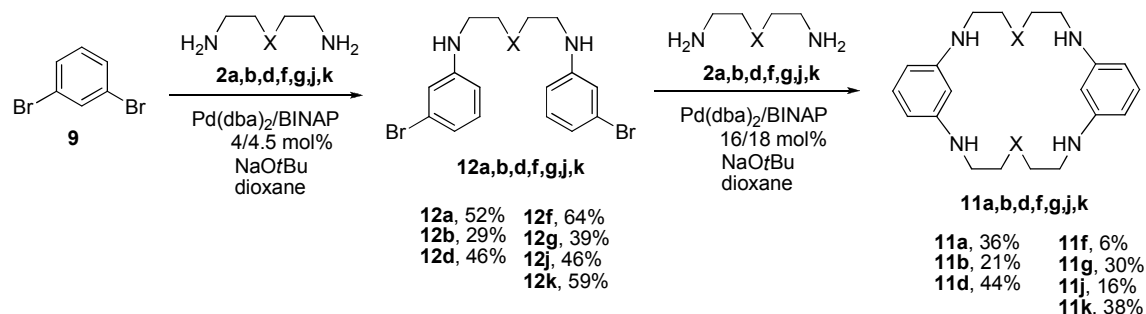

Scheme 7

In all cases, linear oligomeric products, which were formed due to an easy diamination of 1,3-dibromobenzene, were isolated in notable yields. To synthesize macrocycles, the reactions of bis(3-bromo-

benzene) polyamines **12** with corresponding polyamines **2** were run in the presence of increased amount of catalyst (16 mol%) and in dilute dioxane solutions. Under these conditions, cyclodimers **12** were prepared in quite good yields (up to 44%) (Scheme 7).

2.2. Macrocycles with biphenyl units

Macrocycles containing biphenyl unit attract a constant interest of researchers due to their original structure which combines a flexible polyoxa- or polyazaalkyl chain with a rigid non-planar aryl moiety. The majority of reported macrocycles were synthesized by non-catalytic reactions. Cyclic polyethers were prepared from 2,2'-dihydroxybiphenyl,^{58–60} and used for selective complexation of *tert*-butylammonium cation.⁵⁹ Macrocycles of similar structure, in which one or two polyoxaethylene chains are attached to one biphenyl unit, were studied in the transport of Li⁺, Na⁺, K⁺ cations^{61,62} and of Hg(CF₃)₂^{63,64} through a liquid membrane. Polyoxadiaminomacrocycles were also synthesized from 2,2'-disubstituted biphenyl and their complexation of primary alkylammonium cations, including chiral ones, was studied.⁶⁵ Polyazamacrocycles with 3, 4 and 8 nitrogen atoms were investigated for Cu²⁺, Zn²⁺ and [PdCl₄]²⁻ complexation.⁶⁶ Cyclic triamides⁶⁷ as well as cyclic Schiff bases (trianglimines)^{68,69} comprising three 3,3'- or 4,4'-disubstituted biphenyl moieties were prepared and briefly investigated.

To prepare new macrocycles of this family, the reactions of isomeric dibromobiphenyls with polyamines in the presence of Pd catalyst were studied.^{70,71} When the reactions of 4,4'-dibromobiphenyl (**13**) were run with equimolar amounts of oxadiazines **2b,j,k**, the yields of the macrocycles **14** comprising one biphenyl and one oxadiazine units were low (0–10%). Cyclooligomers **15b,j,k** were isolated in better yields, showing steric demand of 4,4'-dibromobiphenyl moiety for the long-chain polyamines.

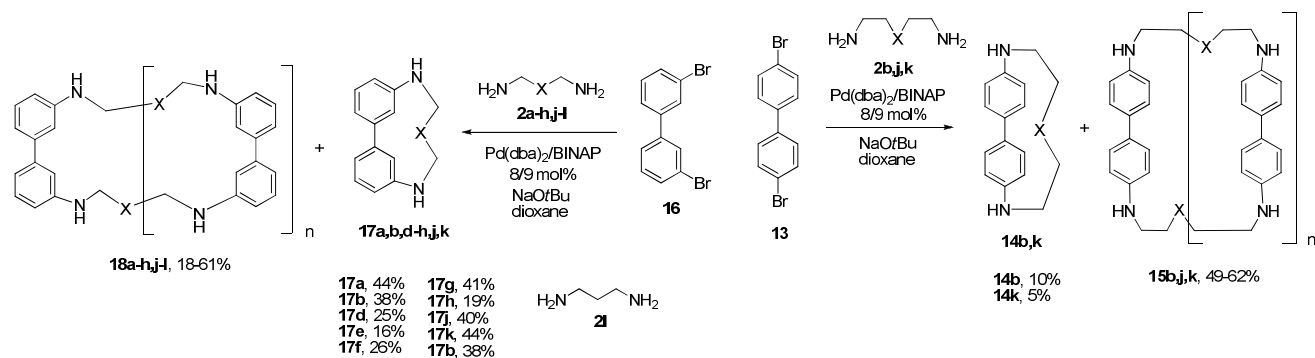

Scheme 8

Much better results were obtained in the reaction of 3,3'-dibromobiphenyl (**16**) with dioxadiazines **2b,j,k**, propane-1,3-diamine **2l**, tri-, tetra- and pentaamines **2c–h** under the same conditions (Scheme 8). As expected, propane-1,3-diamine (**2l**) was too short to give a desired macrocycle as was also diethylenetriamine (**2c**) (7 atoms in the chain). Only cyclooligomers of higher masses were obtained in these reactions. Polyamines which were longer than triamine **2c** (9 and more atoms) successfully afforded target macrocycles **17** in the yields from moderate to good. The best yields (44%) were obtained using dioxadiazine **2k** and tetraamine **2a**.

Two synthetic approaches to cyclic dimers **15** and **18**, *i.e.* routes A and B (Scheme 2), were compared.⁷² Route A, *via* intermediate *N,N'*-bis(bromobiphenyl) substituted polyamines **19** and **20**, gave moderate yields of target compounds due to the side formation of linear oligomers (Scheme 9).

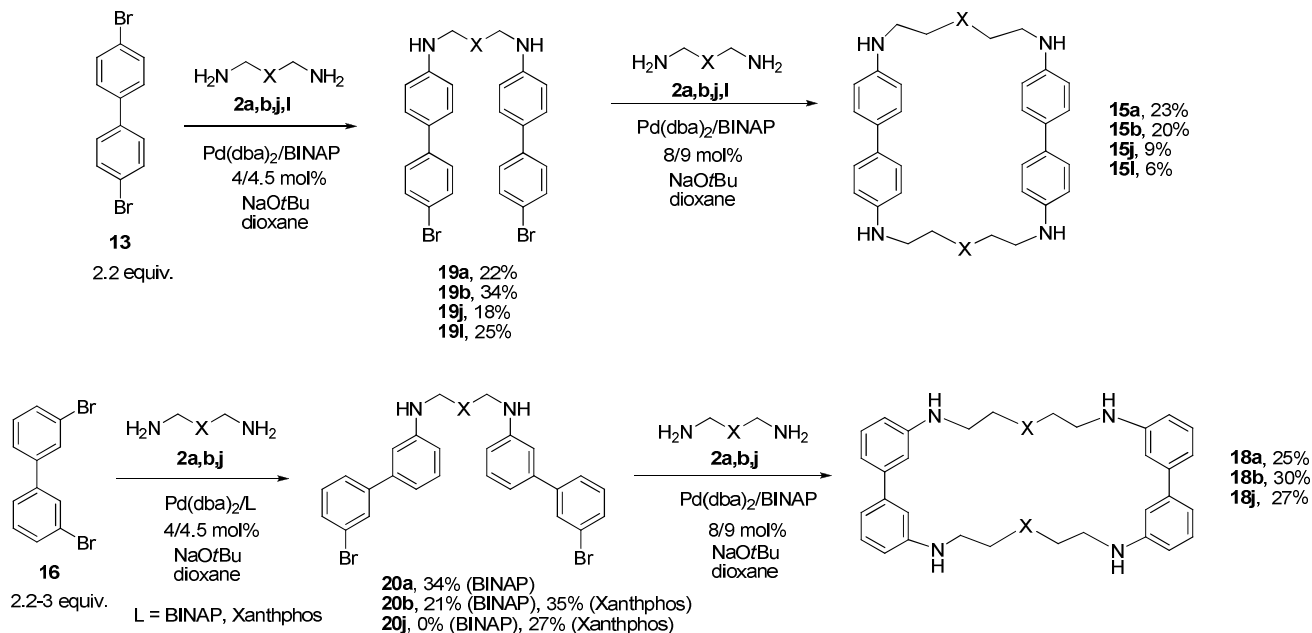

Scheme 9

9,9-Dimethyl-4,5-bis(diphenylphosphino)xanthene (Xanthphos) ligand proved to be more efficient than BINAP in the synthesis of intermediate compounds **20** since *N,N*-diarylation of primary amino groups does not proceed under these conditions. The yields of target cyclodimers **15** and **18** were shown to be strongly dependent on the nature of polyamine. The attempts to carry out one-pot reaction (*in situ* use of intermediate linear derivatives **19** and **20**) were unsuccessful. One-pot synthesis of cyclodimers **15** and **18** *via* bis(polyamine) substituted biphenyls **21** and **22** was more efficient. For example, cyclodimer **18j** was prepared in 44% yield (Scheme 10).

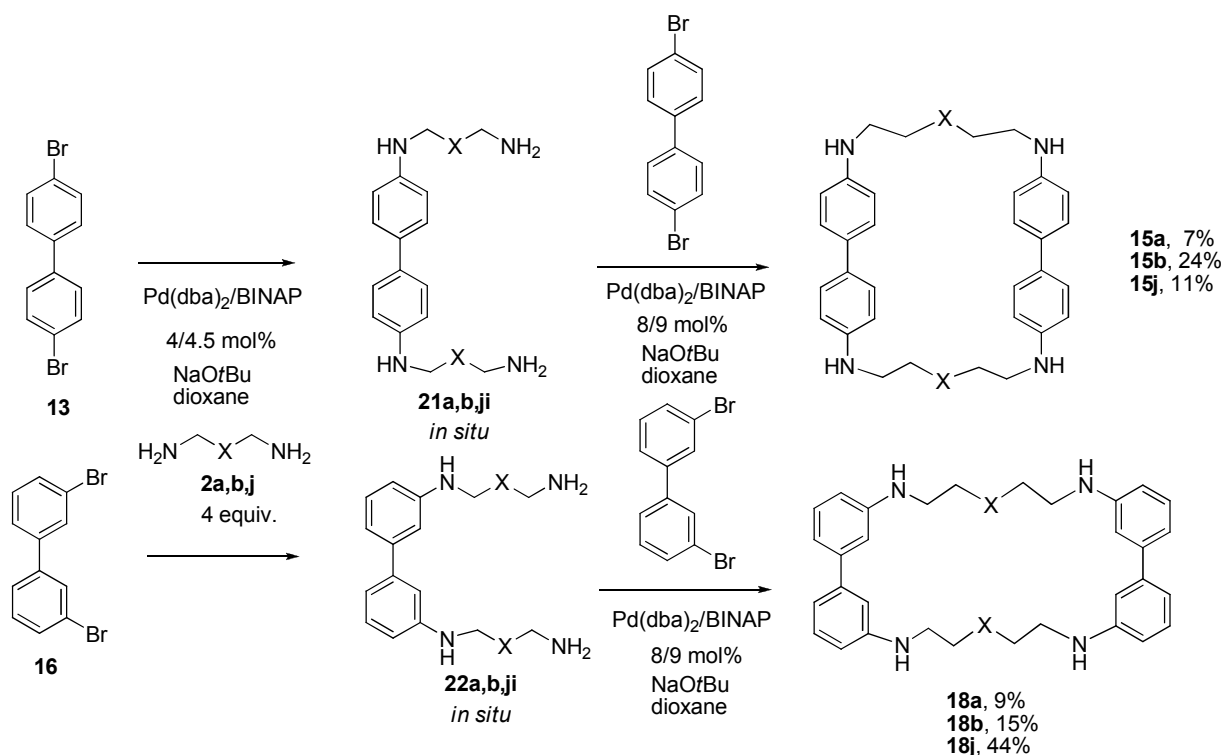

Scheme 10

2.3. Naphthalene-based macrocycles

During last decades, a large number of macrocycles bearing naphthalene unit in the macrocycle or in pendant arms were reported. These macrocycles comprise different functionalities such as Schiff bases,⁷³ diamide,⁷⁴ diimide,⁷⁵ or lactam⁷⁶ groups. Naphthalene fragment can be attached to tetraazamacrocycles,⁷⁷ the molecules may contain phosphorus atoms⁷⁸ or have only carbon atoms in the macrocycle.⁷⁹ Naphthalene moieties were also incorporated in more sophisticated structures like calixarenes,⁸⁰ catenanes,⁸¹ porphyrins.⁸² These molecules were used as molecular receptors, particularly of organic anions,⁸³ or as molecular rotors.⁸⁴

In our previous investigations, we demonstrated that 1-bromonaphthalene was among the most reactive aryl halides in Pd-catalyzed amination reaction.⁴² Thus we tried 1,8-dibromonaphthalene in the macrocycle synthesis, but it did not react at all even after a long reflux. Probably the second bromine substituent in *peri*-position totally hindered the oxidative addition of 1,8-dibromonaphthalene to Pd(0). Then we ran the reactions of 2,7-dibromonaphthalene (**23**) with polyamines **2a,b,d-k** (Scheme 11).⁸⁵ Desired macrocycles **24** were obtained in all studied reactions except for the shortest triamine **2d**. Amines **2f,j** also provided macrocycles **24f,j** in low yields due to insufficiently long chains.

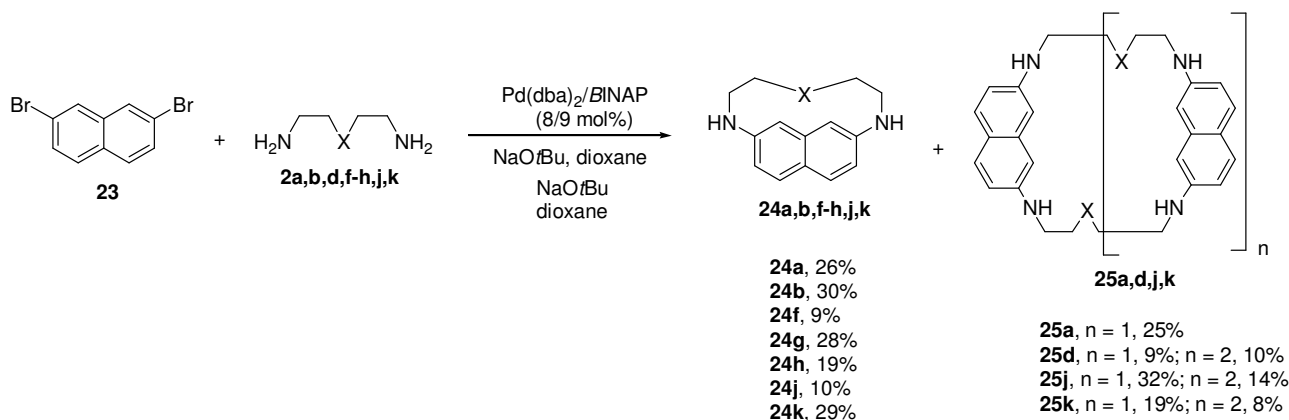

Scheme 11

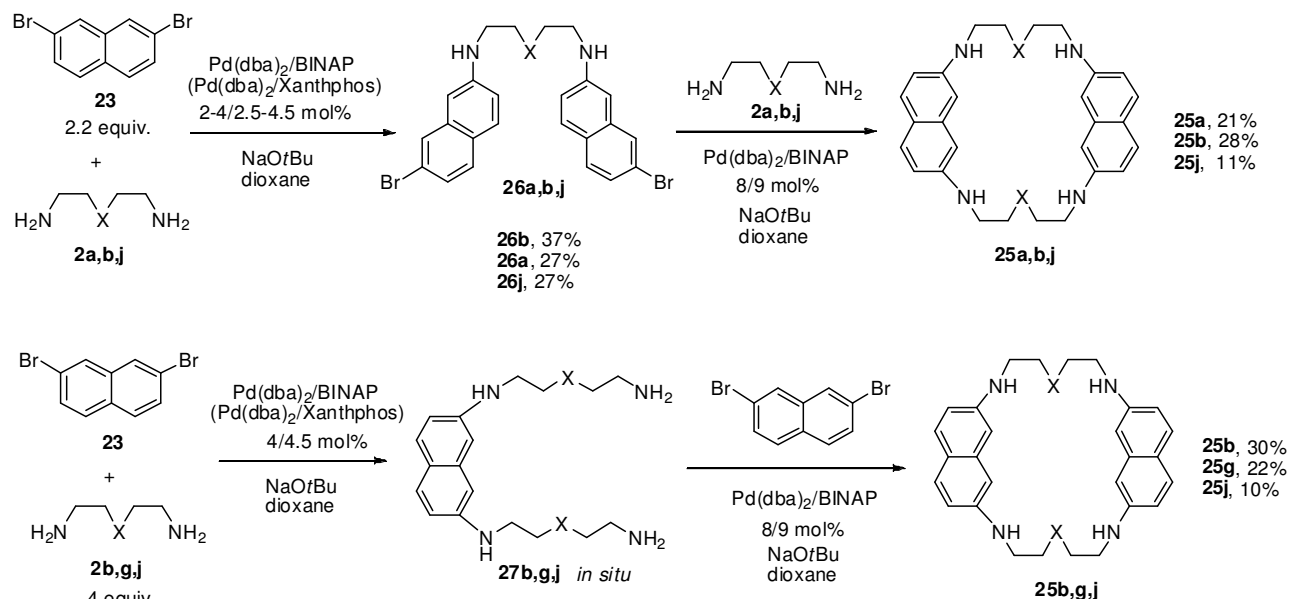

Scheme 12

The synthesis of cyclic dimers **25** was carried out using both methods A and B: *via* diarylated derivatives **26** and *via* bis(polyamine)substituted naphthalenes **27** which were used *in situ* (Scheme 12). The second route was more convenient and afforded better yields of cyclodimers **25**.

2.4. Macrocycles comprising anthracene and anthraquinone fragments

Aminosubstituted anthracenes and anthraquinones are of special interest due to their optical properties. Macrocycles comprising anthracene and anthraquinone moieties are known to be efficient colorimetric and fluorescent sensors for ions and polar molecules. 9,10-Disubstituted anthracene^{86–90} and 1,8-disubstituted anthraquinone derivatives are widely used to synthesize macrocyclic compounds which contain these units as a part of the cycle.^{91–94} Different linear fragments (oxadiazine⁸⁶ or polyoxyethylene chains,^{87,95} chains bearing acetylene fragments^{89,90}) are used to design the anthracene-based macrocycles. Polyoxyethylene fragments are also frequent in anthraquinone-based macrocycles,^{91,92} cryptands,^{93,94} and catenanes.⁸⁷ These macrocycles were used as probes for metal cations like Li⁺, Na⁺, Pb²⁺^{91,93,94} and their complexation with DNA has been recently studied.^{86,96}

We developed an easy one-pot catalytic procedure for the synthesis of polyaza- and diazapolyoxamacrocycles by the diamination of 1,8-dichloroanthracene (**28**) and 1,8-dichloroanthraquinone (**31**).^{97–99} These reactions were catalyzed by Pd(dba)₂/BINAP (8–16/9–18 mol%) system. Sodium *tert*-butoxide was applied as a base in the reactions of 1,8-dichloroanthracene (**28**) and cesium carbonate was used in the case of 1,8-dichloroanthraquinone (**31**). This protocol afforded target macrocycles **29** and **32** in the yields up to 43% (Scheme 13). It was found that the nature of dihaloarene and polyamine affected the yield, however, no strict regularities were observed. Cyclodimers **30** and **33** were also isolated in pure state.

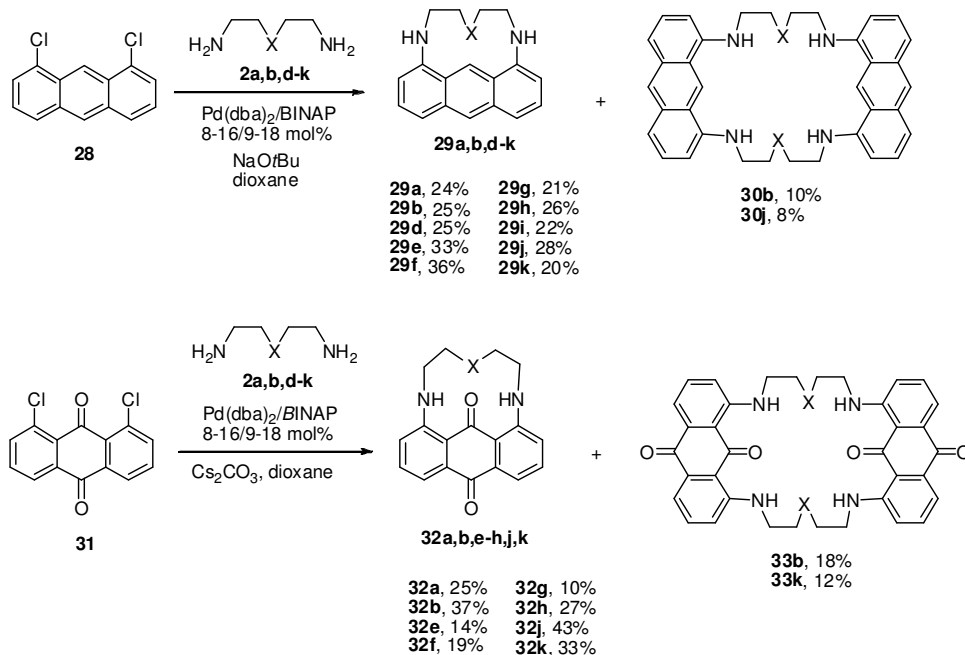

Scheme 13

The reactions of isomeric 1,5-dichloroanthracene and 1,5-dichloroanthraquinone **34** and **37** were found to be more difficult because of steric demands for ring closure (Scheme 14). 1,5-Dichloroanthracene (**34**) gave macrocycles **35** with tetraamines **2a,f,g** and oxadiazines **2b,k** which possess 11–15 atoms in chain,

while the reaction with a shorter tetraamine **2e** and dioxadiazine **2j** (10 atoms) produced only cyclic and linear oligomers.

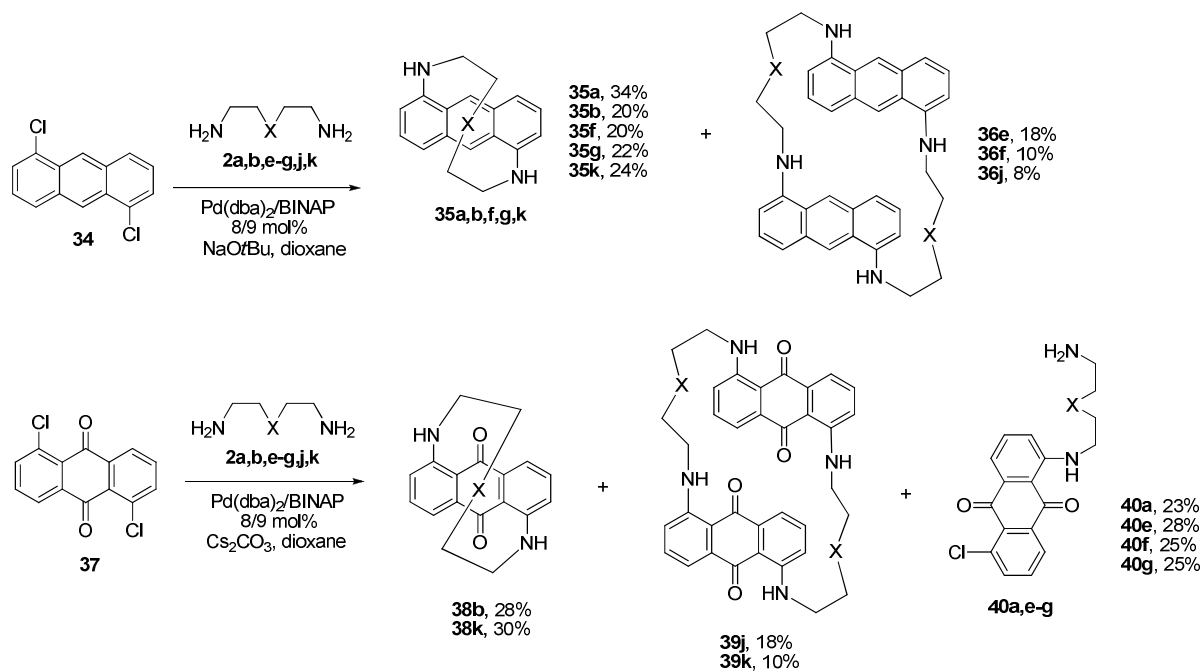

Scheme 14

1,5-Dichloroanthraquinone (**37**) gave desired products **38b,k** only with enough long oxadiazines **2b,k**. For other polyamines **2a,e-g**, non-cyclic compounds **40a,e-g** were the only products isolated in these reactions. Macrocycles **35b,k** and **38b,k** possess planar chirality and we optimized the conditions for their enantioselective synthesis.¹⁰⁰ Nine chiral phosphane ligands (Fig. 3) were studied and Josiphos SL-J002-1 was found to be the most efficient in the reactions of 1,5-dichloroanthraquinone **37** with di- and trioxadiazines **2b,k**. It provided the products with 58–60% *ee* and after crystallization from acetone or CH₂Cl₂-hexanes pure major enantiomers of macrocycles **38b,k** were obtained as monocrystals and studied by X-ray analysis.

In the reaction of 1,5-dichloroanthracene (**34**) with polyamines **2b,k** the same ligand afforded *ee* of chiral macrocycles **35b,k** up to 45%.

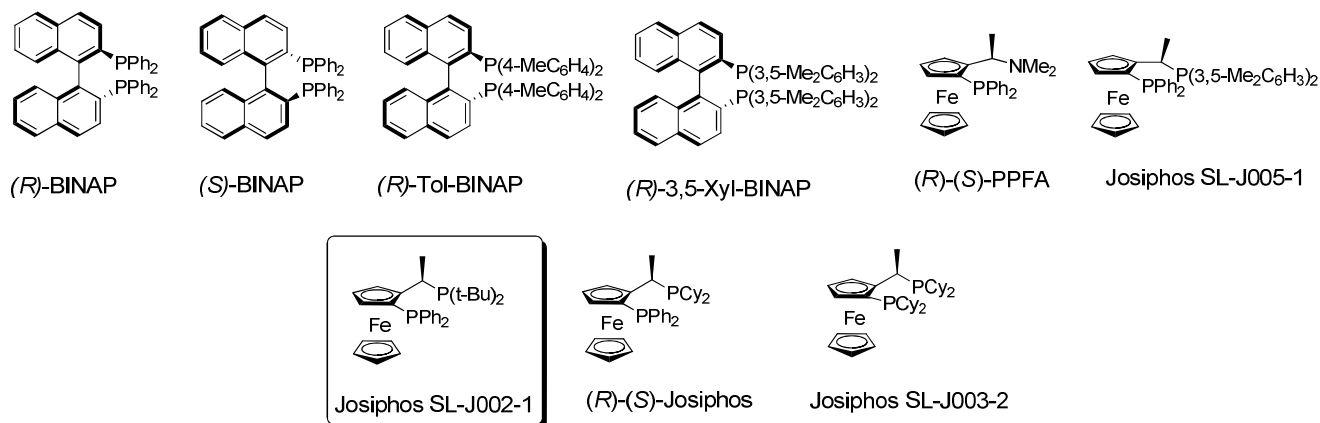
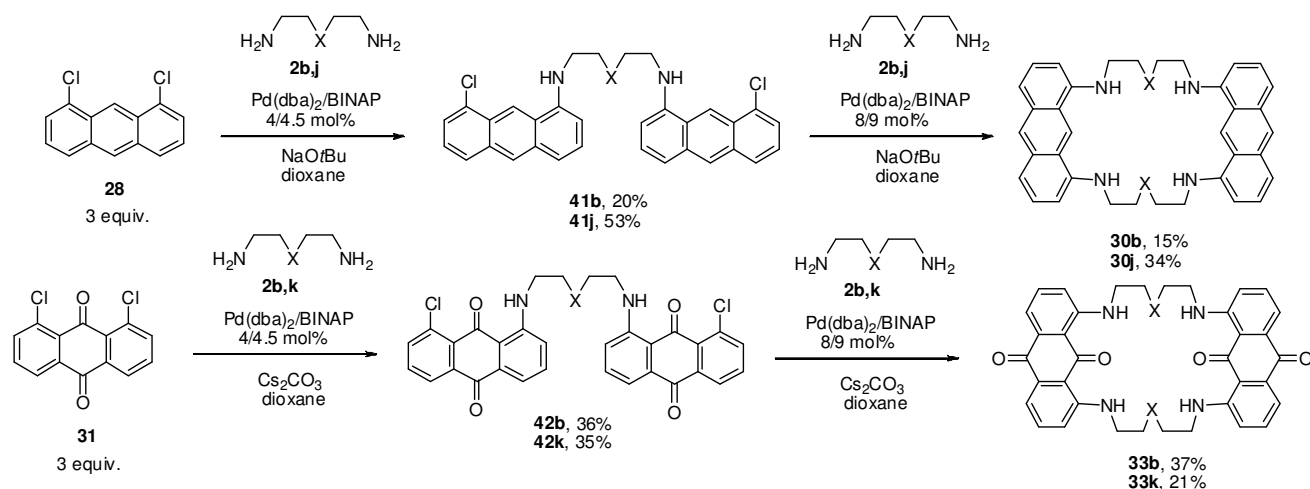
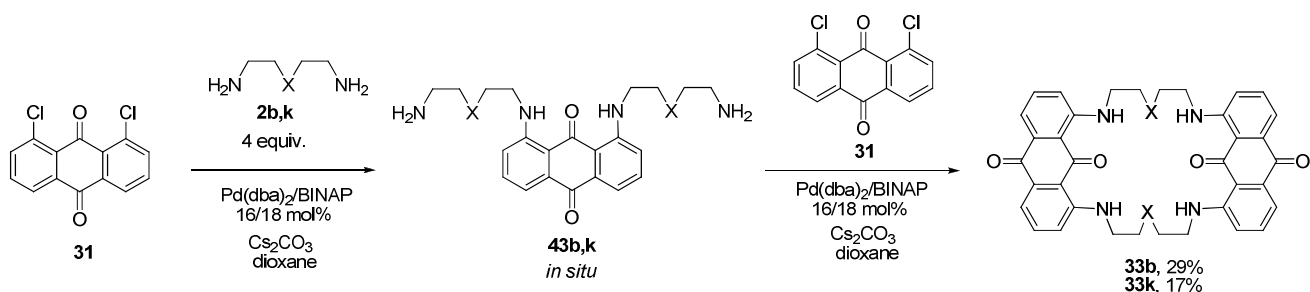

Figure 3

Then the synthetic approaches to cyclic dimers **30** and **33** were studied in details.^{101,102} The synthesis of both types of cyclodimers was successful *via* *N,N'*-di(chloroaryl)substituted oxadiazines **41** and **42** (method A, Scheme 2 and Scheme 15). However, a one-pot method B *via* bis(polyamine) derivatives **43** was efficient only for the reaction of 1,8-dichloroanthraquinone with oxadiazines **2b,k** (Scheme 16).



Scheme 15



Scheme 16

3. Macrocycles containing hetaryl moieties

3.1. Pyridine-based macrocycles

Substantial interest was evoked by the synthesis and coordination properties of different polyazamacrocycles which possess pyridine moiety in the macrocyclic ring.^{103–115} The pyridine fragment strongly influences the thermodynamic properties and the complexation kinetics by increasing the conformational rigidity of the ligand and by changing its basicity. Of great importance are also polyazamacrocycles with terpyridine units due to their conformational rigidity.¹¹⁶ In almost all known macrocycles of such type, nitrogen atoms of the polyamine chain and pyridine ring are separated by methylene, methyne or carbonyl groups. For example, the synthesis of a number of pyridine-containing macrocycles by the reaction of dimethyl pyridine-2,6-dicarboxylates has been recently reported.¹¹⁷ A single compound with C(sp²)-N bond was obtained by reduction of the corresponding diamide formed from 2,6-diaminopyridine and bis(acylchloride).¹¹⁸ We decided to apply Pd-catalyzed amination reaction to the synthesis of these macrocycles.

2,6-Dibromopyridine **44** was reacted with polyamines **2a–j** taken in equimolar amounts in order to obtain macrocycles **45**.¹¹⁹ The reactions were run using Pd(dba)₂/BINAP catalytic system (4–8/6–12 mol%) in dilute dioxane solutions (0.01–0.02 M) for 5–15 h (Scheme 17).

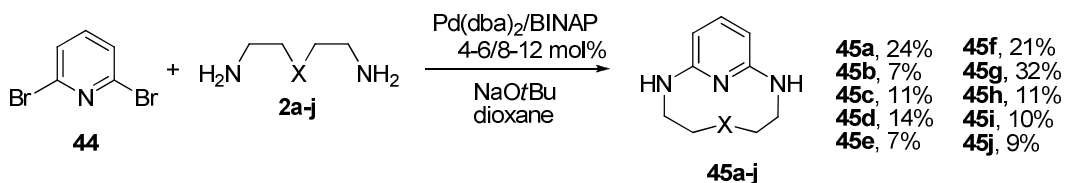

Scheme 17

The yields of target macrocycles **45** were strongly dependent on the nature of polyamines **2a–j**. While the reactions of tetraamines **2a,f,g** afforded 21–32% yields of macrocycles **45a,f,g**, short triamines **2c,d**, polyamines with repeating ethylenediamine unit **2e,h,i** and oxadiazines **2b,j** provided low yields of corresponding macrocycles. Attempts to employ donor phosphine ligands like DavePHOS, 2-(dicyclohexylphosphino)biphenyl and 2-(di(*tert*-butyl)phosphino)biphenyl were totally unsuccessful.

To synthesize macrocycles containing two pyridine and two polyamine fragments (*i.e.* cyclodimers), two alternative methods A and B were used (Schemes 2 and 18).^{120,121} According to the method A, polyamines were first heteroarylated with 3 equiv. of 2,6-dibromo- or 2,6-dichloropyridines. The reaction of tetraamine **2a** with 3 equiv. of 2,6-dibromopyridine (**44**) provided the target bis(bromopyridyl) substituted tetraamine **46a** in 28% yield, while the use of 3 equiv. of 2,6-dichloropyridine (**47**) in this reaction led to a higher yield (43%) of the desired products **48a**. Moreover, dibromo derivative **46a** provided the cyclodimer **50a** in a poorer yield (16%) than dichloro derivative **48a** (38%), due to excessive formation of linear oligomers. Thus 2,6-dichloropyridine was used as starting compound to synthesize other symmetrical cyclodimers **50f,j**. The same procedure was applied for the synthesis of macrocycles **50l,m** containing two different polyamine chains (Scheme 18).

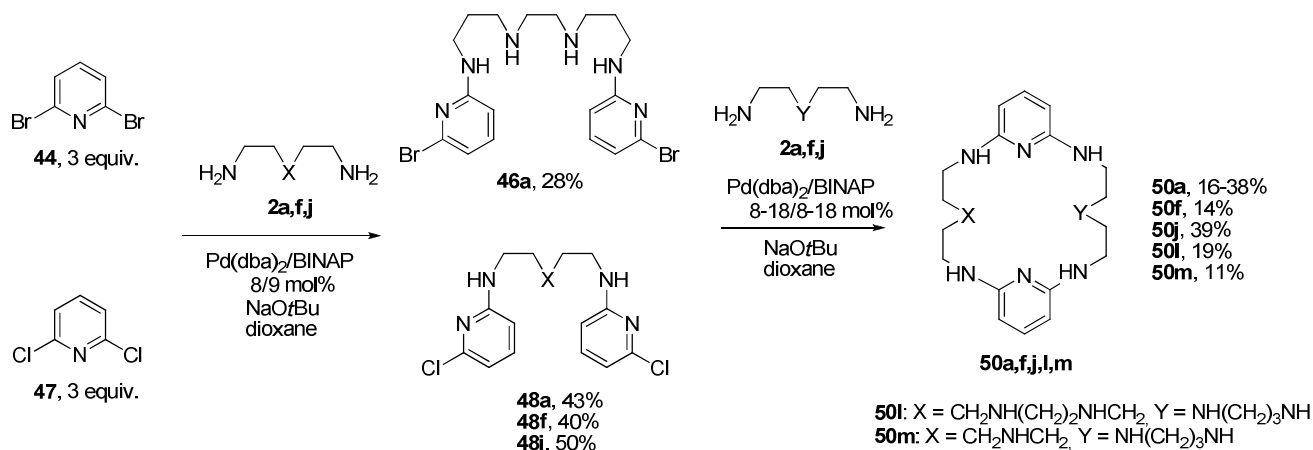

Scheme 18

According to the method B (Scheme 19), the intermediate 2,6-bis(polyamine)pyridines **49** were formed by the reaction of 2,6-dibromopyridine (**44**) with 4 equiv. of polyamines **2** and were used further *in situ*. Cyclodimer **50a** was isolated in 49% yield, while cyclodimer **50j** was observed in the reaction mixture in trace amounts.

Polyazamacrocycles containing 3,5-disubstituted pyridine moiety were yet unknown. These macrocycles could be ditopic ligands if *exo*-orientation of pyridine nitrogen atom is provided by steric demand of the macrocycle (*i.e.* macrocycle is not very large). 3,5-Dibromopyridine (**51**) was reacted with equimolar amounts of polyamines **2a–j** (Scheme 20) affording target macrocycle **51a–j**.^{122,123}

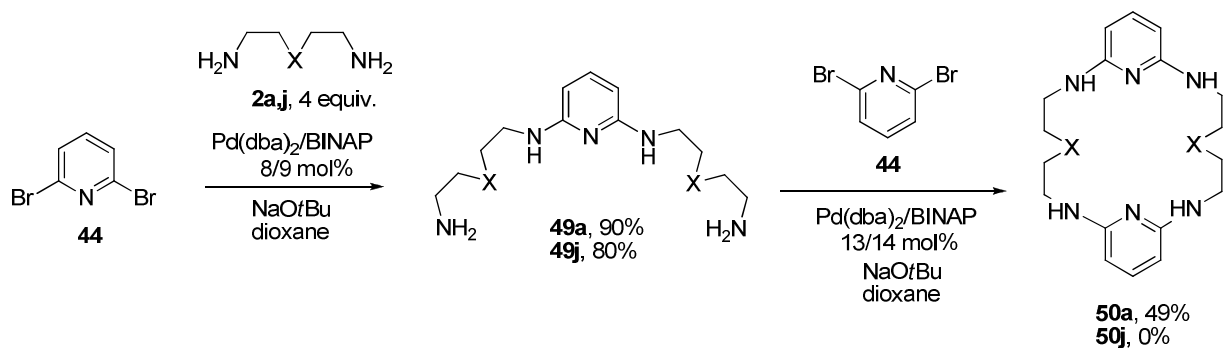

Scheme 19

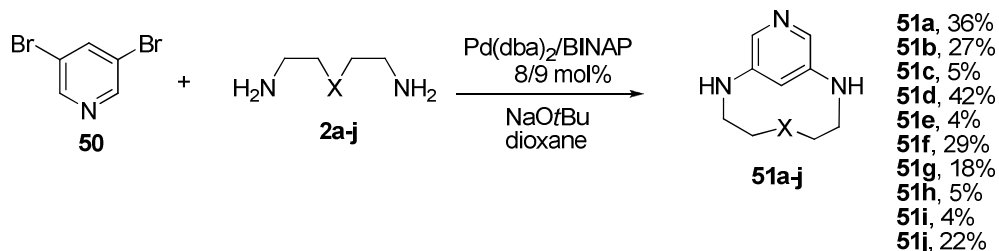

Scheme 20

Polyamines **2a,b,d,f,g,j** gave the macrocycles **51** in the yields from 18 to 42%, whereas in the case of polyamines **2c,e,h,i**, the yields did not exceed 5–6%. The latter polyamines comprise only ethylenediamine fragments while first set of polyamines either do not have such fragments at all, or contain both ethylenediamine and triethylenediamine moieties. Ethylenediamine is known to be efficient chelating ligand, thus polyamines **2c,e,h,i** could coordinate Pd(0) forming complexes inert in catalysis.

As diamination of 3,5-dibromopyridine (**50**) is difficult, selective synthesis of di(halopyridyl)-substituted polyamines **52** is possible under appropriate reaction conditions (Scheme 21). *N,N'*-Diarylation of polyamines **2a,b,d,j** using 2.2 equiv. of dibromopyridine afforded compounds **52a,b,d,j** in 48–90% yields. Interestingly, the reaction of dibromopyridine with an excess of polyamines **2a,d** (4 equiv.) proceeded smoothly giving 3,5-bis(polyamino)-substituted pyridines **53a,d** in excellent yields.

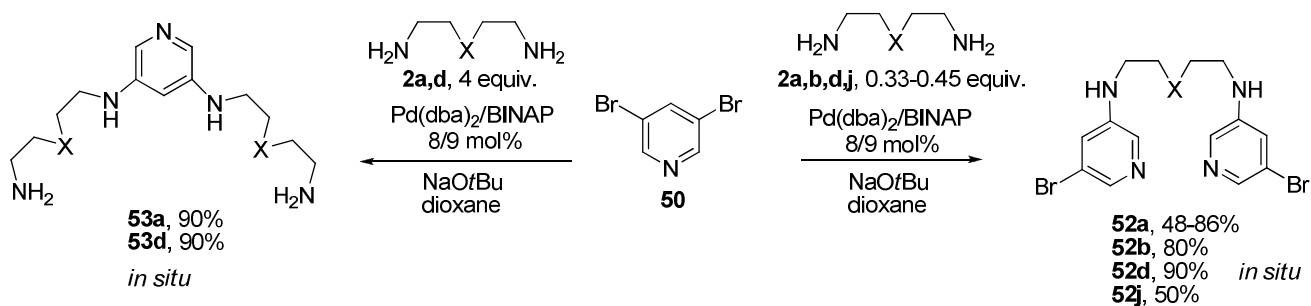

Scheme 21

Compounds **52** and **53** were used *in situ* in the synthesis of cyclic dimers **54**. The reactions of **52a,b,d** according to method A provided cyclodimer **54a,b,d** in 12–15% yields (Scheme 22). Longer heating and the increase in the catalyst loading did not ameliorate the yield of the target molecules. Compound **52j** did not react with **2j** under these conditions. According to method B, cyclodimer **54a** was obtained in 12% yield.

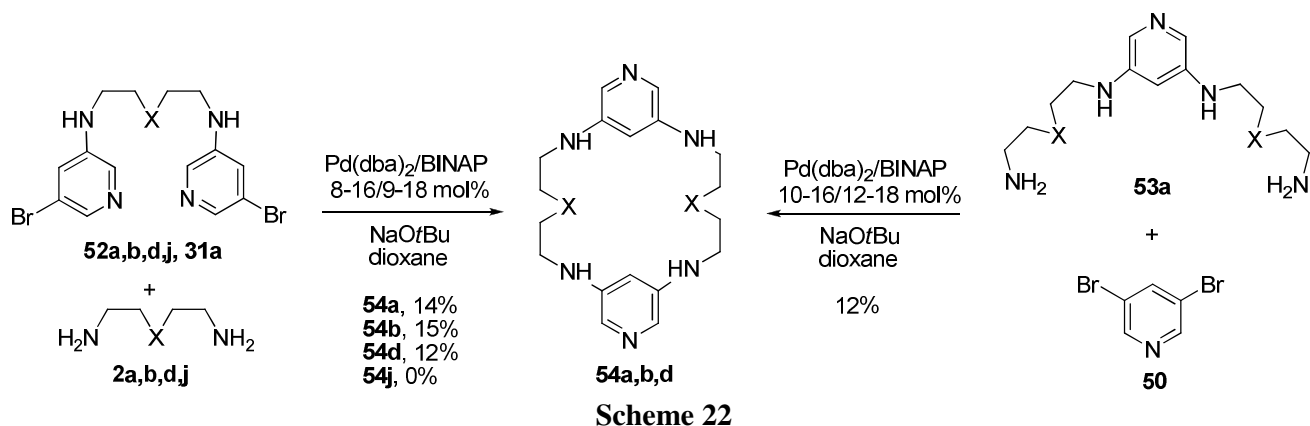

3.2. 2,2'-Bipyridine-containing macrocycles

2,2'-Bipyridine and its derivatives are widely used as chelating ligands. Among these compounds, macrocycles comprising bipyridine moiety as a part of the macrocycle are of great interest. The majority of macrocycles of this type contain 6,6'-disubstituted 2,2'-bipyridine units. They may be linked to polyoxyethylene¹²⁴ or polythiaethylene¹²⁵ chains, tetraamines,¹²⁶ polyazacryptands,¹²⁷ acetylene-containing chains.¹²⁸⁻¹³⁰ 6,6'-Disubstituted 2,2'-bipyridine moieties are present in rotaxanes¹³¹ and catenanes.¹³² Moreover, this fragment is a convenient spacer for attaching two macrocycles. Both azacrown ethers and tetraazamacrocycles were linked by this spacer using Pd-catalyzed amination reactions.^{133,134}

We studied the Pd-catalyzed amination reaction of 6,6'-dibromo-2,2'-bipyridine **56** with linear polyamines **2a,b,d,f,g,j-m** (Scheme 23) trying to synthesize macrocycles bearing 6,6'-disubstituted 2,2'-bipyridine unit in the cycle.¹³⁵ Short diamines **2a,l** provided only cyclic dimers and cyclooligomers **58**, tri- and tetraamines which possess 9 and 11 atoms in the chain afforded macrocycles **57d,f** in low yields, while tetraamines **2a,g** (12–13 atoms) provided 20–29% yield of **57a,g**. The best yields up to 48% were obtained with the longest oxadiazines **2b,k**.

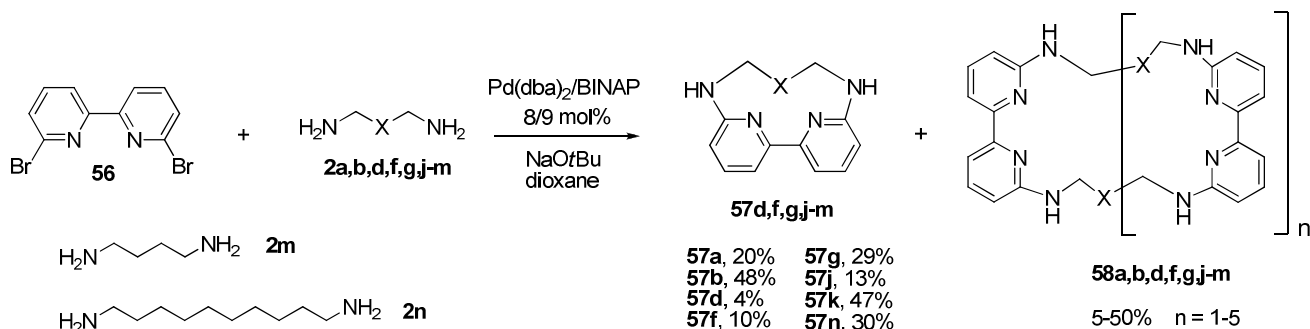

Our attempts to synthesize cyclodimers **58** (n=1) in reasonable yields according to both methods A and B (Scheme 2) failed.

3.3. Macrocycles with pyrimidine units

Aminopyrimidines are versatile biologically active compounds. Macrocycles comprising 4,6-diaminopyrimidine^{136,137} and 2,4-diaminopyrimidine¹³⁸⁻¹⁴⁰ moieties were synthesized by non-catalytic methods. Recently, we have investigated the amination of 2-chloropyrimidine and 2,4-dichloropyrimidine using

diamines.¹⁴¹ 2,4-Dichloropyrimidine (**59**) was found to react with primary and secondary amines taken in excess under non-catalytic conditions providing 2,4-bis(diamine) derivatives.

To prepare the pyridine-based macrocycles, the reactions of dichloropyrimidines with equimolar amounts of diamines in enough diluted solution should be carried out. 2,4-Dichloropyrimidine (**59**) cannot be diaminated under these conditions without catalyst and Pd catalysis is needed to achieve the second intramolecular amination. We abstained from the use of tri- and tetraamines because chloropyrimidines react with secondary amines, thus primary and secondary amino group of polyamines can competitively react with 2,4-dichloropyrimidine. The reactions of equimolar amounts of 2,4-dichloropyrimidine (**59**) and oxadiazines **2b,j,k** in 0.05 M dioxane solutions were catalyzed by Pd(dba)₂/BINAP (4–8/16 mol%). Macrocycles **60b,j,k** were prepared in 6–11% yields (Scheme 24).¹⁴²

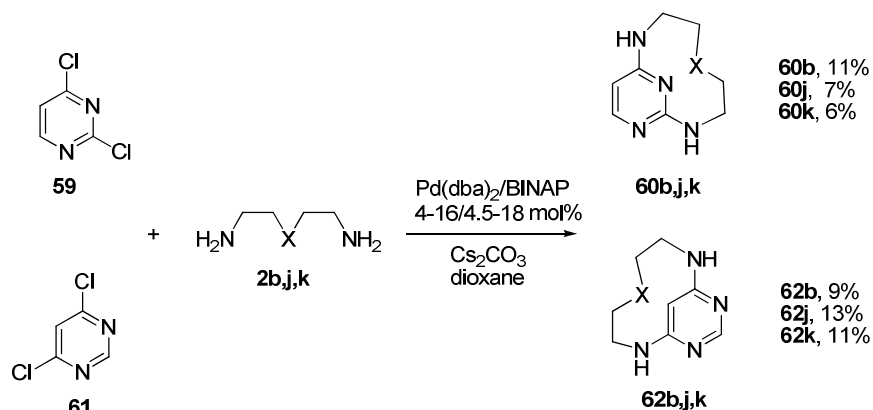

Scheme 24

The reaction of the isomeric 4,6-dichloropyrimidine **61** with the same diamines gave similar results (Scheme 24). The yields of macrocycles **62b,j,k** ranged from 9 to 13%. We tried to optimize the product yields varying the catalytic system. However, Xanthphos and DavePHOS provided only acyclic monoamination products and *N,N*-dimethyl-1-[2-(diphenylphosphino)ferrocenyl]ethylamine was as efficient as BINAP.

Thus higher reactivity of hetaryl halides in nucleophilic substitution reactions as compared to aryl halides did not lead to higher yields of the target macrocycles and cyclodimers. Indeed, the cyclization reaction competes with numerous side reactions presented on Scheme 1 and more reactive substrates give less selective transformations.

4. Macrocycles incorporating adamantane fragment

Encouraged by a success in the synthesis of macrocycles using the Pd-catalyzed amination of aryl and heteroaryl halides by linear polyamines, we studied the amination of aryl halides by adamantane-containing diamine **63** in order to introduce 1,3-disubstituted adamantane moiety in the macrocycle. Diamine **63** was reacted with 1,3-dibromobenzene, 2,6-dibromopyridine, 2,7-dibromonaphthalene, 3,3'-dibromobiphenyl, 1,8- and 1,5-dichloroanthracenes and 1,8- and 1,5-dichloroanthraquinones in the presence of Pd catalyst (Scheme 25).^{143,144} As expected, the reactions of sterically demanding 1,3-dibromobenzene and 2,6-dibromopyridine gave only cyclodimers and cyclooligomers **64** and **65**. 2,7-Dibromonaphthalene gave cyclodimer **68** which was isolated from the mixture of cyclooligomers. Macrocycles **66** and **69** were obtained in the reactions of diamine **63** with 3,3'-dibromobiphenyl (17%) and 1,8-dichloroanthracene (8%). However,

1,5-dichloroanthracene, 1,8- and 1,5-dichloroanthraquinone provided only inseparable mixtures of cyclic and linear oligomers. Thus, 1,3-bis(2-aminoethyl)adamantane **63** which is more rigid than linear diamines gave macrocycles in lower yields.

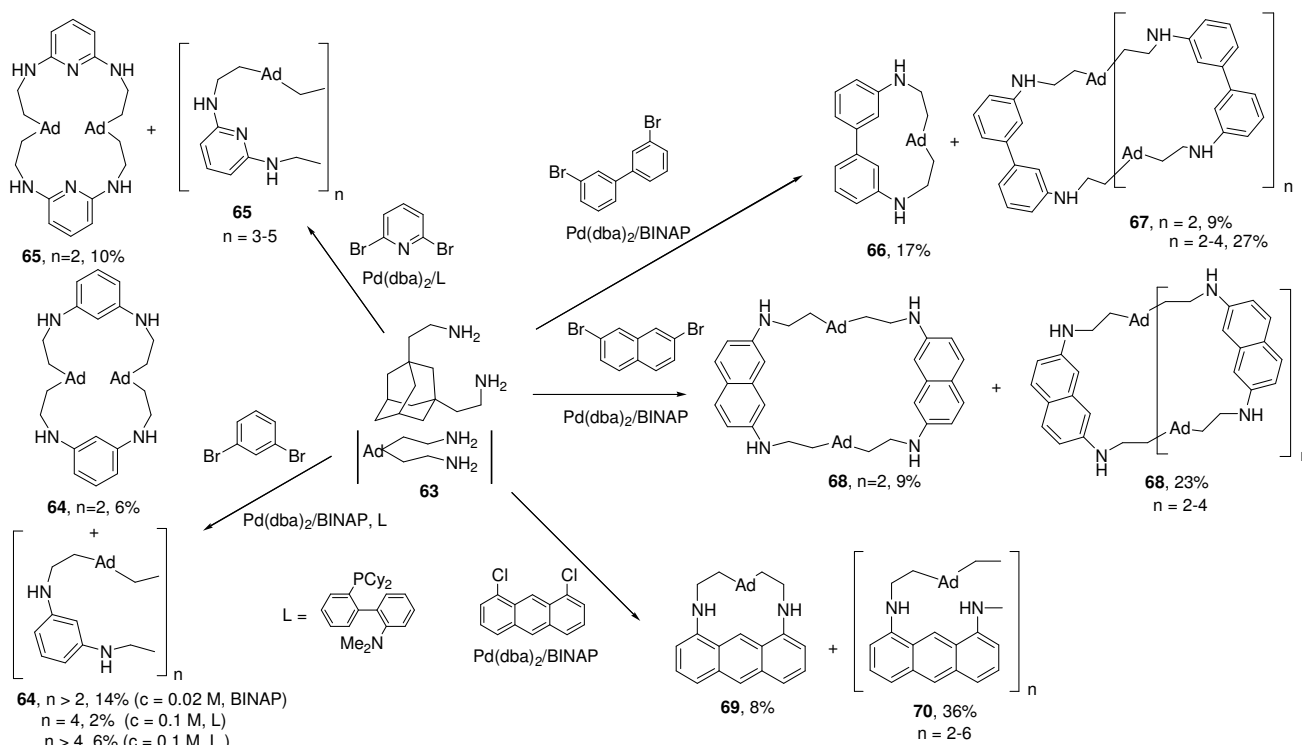

Scheme 25

5. Macrocyclic derivatives of cholanediol

Macrocycles comprising steroidal fragments can be divided into three main groups: cyclocholeates, cholaphanes and other macrocyclic molecules containing steroidal moiety (or moieties) and linkers. Cyclocholeates are macrocyclic lactones obtained by the cyclization of 2–6 molecules of cholic acids in a head-to-tail manner. These macrocycles were obtained using 2,6-dichlorobenzoyl chloride or dicyclohexyl carbodiimide and DMAP *via* Yamaguchi macrolactonization of cholic acids monomers or dimers.^{145–152} Cyclocholeates are macrocyclic molecules with adjustable cavity size for trapping polar organic molecules. Cholaphanes contain 2–4 cholic acids fragments arranged in a head-to-head or head-to-tail manner linked *via* various functional groups.¹⁵³ Cyclodimers are conformationally rigid. Some of them exhibit an extraordinary ability for stereoselective binding of carbohydrates derivatives in organic solvents,^{154,155} and the introduction of an appropriate signaling unit makes them ideal compounds for molecular recognition.¹⁵⁴ Crown ether-like macrocycles containing one steroidal backbone and polyoxaalkyl chain are also known.^{156–159} The size of the cycle and its geometry can be finely tuned by changing the positions of the steroidal moiety for the attachment of polyoxaalkyl chain. However, the syntheses of these macrocycles are multistep and laborious and the product yields are often humble. We applied the Pd-catalyzed amination in the synthesis of new steroidal macrocycles.

First, haloaryl and haloheteroaryl steroid derivatives were obtained by the Mitsunobu reaction of 3,24-cholanediol **71** with 3-bromophenol **72**, 2-chloro-6-hydroxypyridine **73** and 8-chloro-2-hydroxyquinoline **74** (Scheme 26).

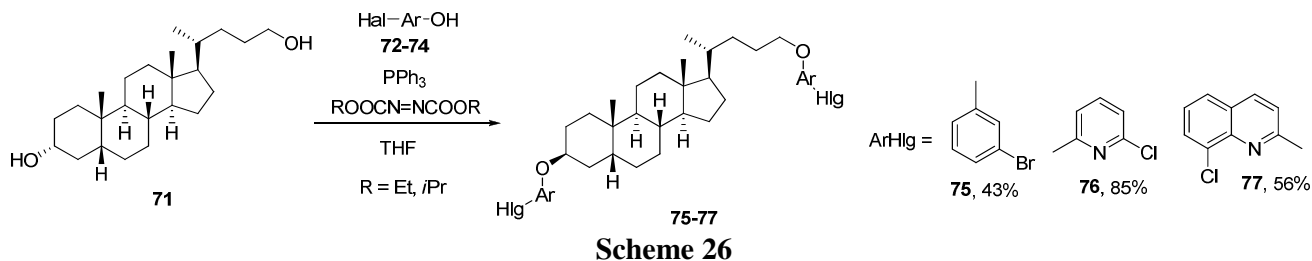

Then 3,24-bis(haloaryloxy)cholanes **75–77** were reacted with polyamines **2**. The reaction path was strongly dependent on the nature of the aryl substituent in the starting steroids. The reaction of 3,24-bis(3-bromophenoxy)cholane (**75**) afforded cyclic dimers **78** with all studied polyamines and oxadiazines in high yields (Scheme 27).^{160,161} The compounds were obtained as the inseparable mixtures of head-to-head and head-to-tail regioisomers.

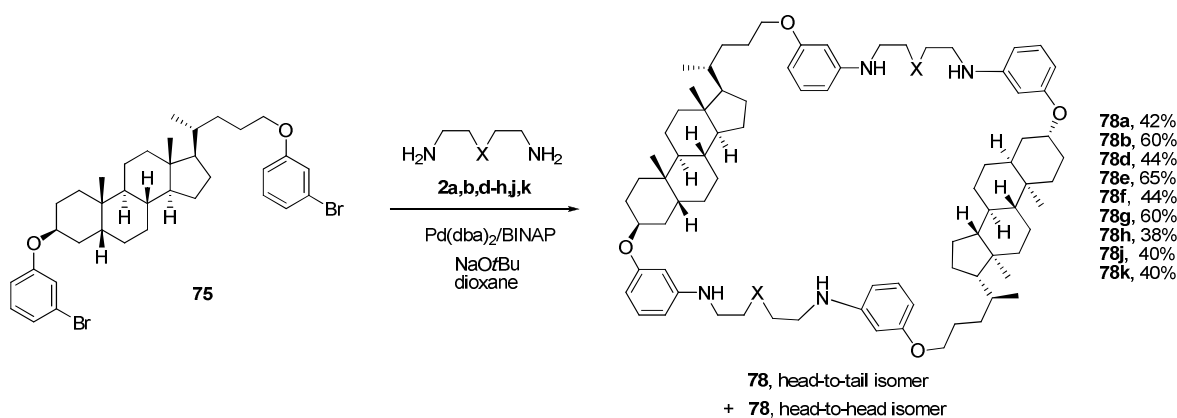

On the contrary, the reactions of 3,24-bis(6-chloropyridin-2-yloxy)cholane (**76**) with long polyamines and oxadiazines **2a, b, d, g, j, k** afforded the mixtures of macrocycles **79** with cyclodimers **80** (Scheme 28).^{162,163} The maximum yields of both monomer and dimer were obtained for tetraamine **2g** (29% and 66%, respectively). Macrocycles **79** were prepared in good yields with dioxadiazine **2k** and trioxadiazine **2b** (22% and 21%, respectively). As expected, the reaction of cholane **76** with short amines **2c, e, i** gave only cyclodimers **80**.

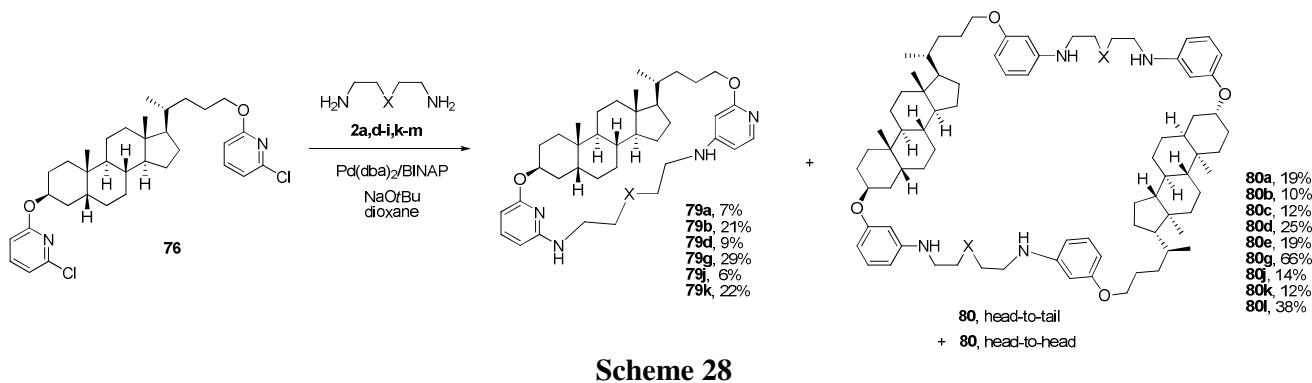

Similar results were obtained in the reactions of 3,24-bis(8-chloroquinolin-2-yloxy)cholane (**77**) with polyamines in the presence Pd(dba)₂/DavePHOS because BINAP was inefficient in these transformations.

The highest yields of macrocycles **81** were obtained with diamines **2b,k** (24% and 22%, respectively)¹⁶⁴ and cyclodimers **82** were separated in all studied reactions (Scheme 29). NMR spectra of macrocycles **81** notably differ from that of cyclooligomers, what helps in a rapid and reliable identification of these compounds.

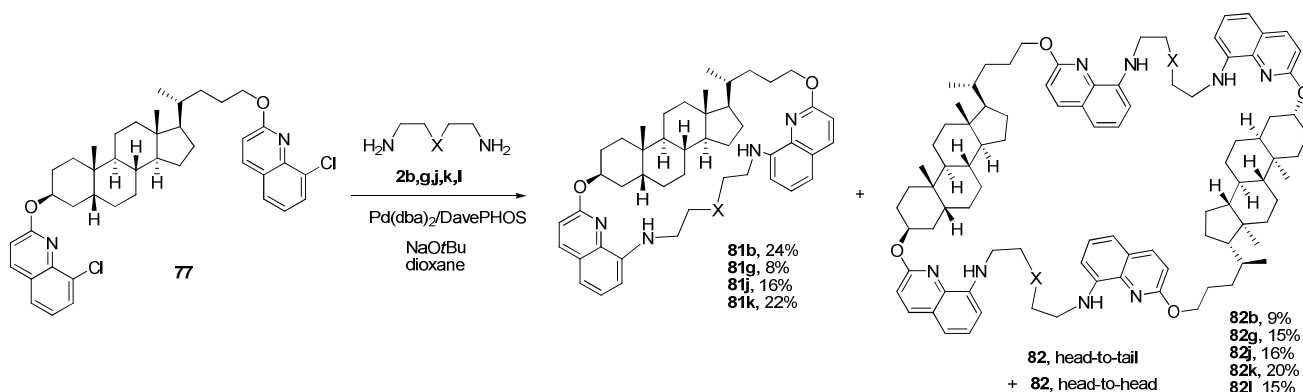

Scheme 29

6. Macropolycyclic compounds

6.1. Macrobi- and macrotricycles derived from substituted cyclen and cyclam

Tetraazamacrocycles, particularly cyclam and cyclen derivatives, are of major importance due to their unique properties for selective binding of metal ions.¹⁶⁵ They are known as highly efficient sequestering agents,¹⁶⁶ sensors,¹⁶⁷ catalysts¹⁶⁸ and they are used in biochemistry¹⁶⁹ or medicine.¹⁷⁰ Moreover, bis(polyazamacrocycles) are interesting ligands giving binuclear complexes and biologically active compounds.¹⁷¹ More sophisticated polyazamacrobicycles of cryptand structure containing cyclen are investigated as ditopic ligands for binding cations and anions.^{172,173} Direct arylation of tetraazamacrocycles was found by us earlier to be quite difficult.¹⁷⁴ It was thought helpful to prepare new macrobicyclic compounds by *N*-alkylation of cyclen and cyclam by halobenzyl halides followed by the Pd-catalyzed amination of the aromatic fragment.

First, novel *trans*-di(halobenzyl)substituted cyclen and cyclam **85–92** were prepared from protected tetraazamacrocycles **83** and **84** (Scheme 30).¹⁷⁵

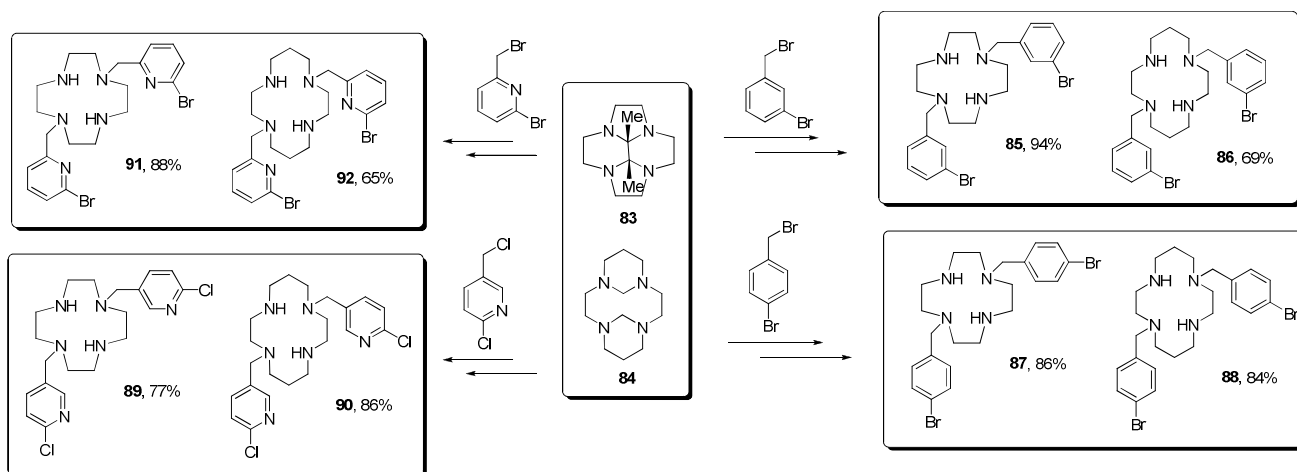

Scheme 30

These compounds were reacted with polyamines and oxadiazines in the presence of Pd catalyst to form macrobicyclic structures (Scheme 31).¹⁷⁶ The reactions of bromo-substituted tetraazamacrocyclic

derivatives **85–88**, **91** and **92** were carried out in the presence of BINAP as a ligand while those of chloro-substituted compounds **89** and **90** gave better yields of the products in the presence of donor ligand DavePHOS. We noted a substantial dependence of the nature of starting cyclen and cyclam derivatives on the yields of the target products.

The best product yields (up to 47%) were obtained in the reactions of *trans*-di(3-bromobenzyl)cyclen **85** and *trans*-di(4-bromobenzyl)cyclen **87**. We did not observe any pronounced influence of the nature of polyamines on the yields of target compounds **93** and **95**, except for the reactions of compound **85** with the shortest propane-1,3-diamine **2i** and compound **87** with tetraamine **2g**. It should be noted that cyclodimers **101** and **103** (up to 32%), which are of great interest as macrotricyclic structures, were also isolated from the reaction mixtures.

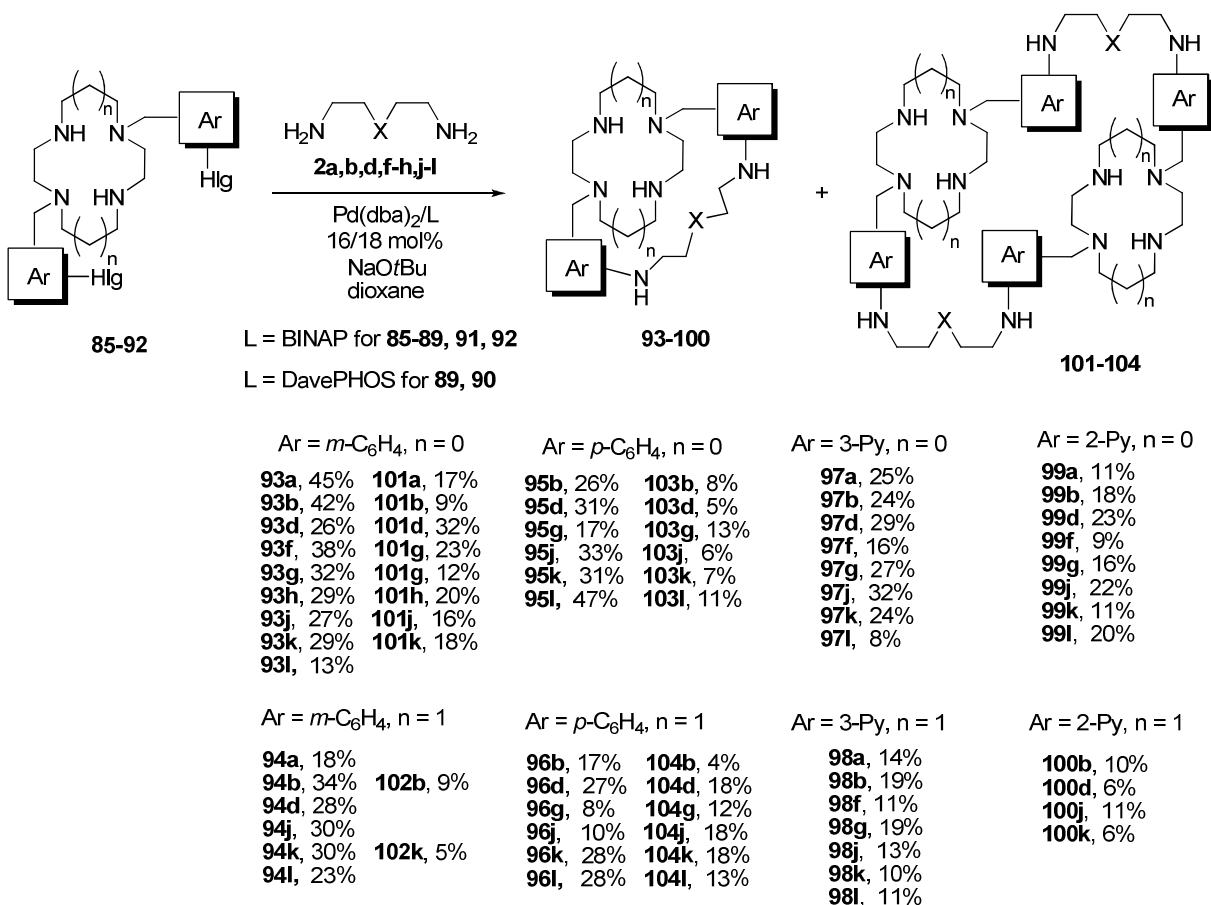

Scheme 31

Cyclam derivatives **86** and **88** also reacted smoothly, but the yields of macrobicyclic compounds **94** and **96** were lower than in the reaction of analogous cyclens **85** and **87**. Cyclodimers **102** were not generally formed in the reactions of *trans*-bis(3-bromobenzyl)cyclam (**86**) except for amines **2b,k**. However, *trans*-bis(4-bromobenzyl)cyclam (**88**) always afforded macrotricyclic dimers **104** and sometimes their yields were higher than those of corresponding macrobicycles **96**.

Pyridine-substituted cyclens and cyclams **89–92** turned to be more difficult substrates in macrocycles formation (Scheme 31). Cyclen derivatives **89** and **91** provided better product yields than analogous cyclam derivatives **90** and **92**. 4-Chloropyrid-3-yl derivatives **89** and **90** reacted better than 6-bromopyrid-2-yl

derivatives **91** and **92** though the latter possess more reactive bromine substituent. Cyclodimers were not isolated from the reaction mixtures, but hydrodehalogenation reactions were observed to a large extent decreasing the yields of desirable products.

Next, we optimized the synthetic procedures for tricyclic cyclodimers **101** and **102** using two alternative approaches A and B described above (Scheme 2). Route A was efficient only if bis(cyclen) derivatives of polyamines **105** were used without isolation from reaction mixtures (Scheme 32). Indeed, the yields of these compounds were low (4–37%) due to competing formation of tris(cyclen) oligomers **106** (11–54%). Moreover, the Pd-catalyzed amination of bis(cyclen)s **105** was efficient in a restricted number of cases. Surprisingly, *in situ* formed intermediates **105** gave good yields (up to 32%) of desired cyclodimers **101**. Under these conditions, cyclic dimers **102** were obtained *via* bis(cyclam) derivatives **107** formed *in situ*. Novel cyclam-containing cyclic dimers **102d,j** were also prepared. These compounds were not observed as by-products in the synthesis of macrocycles **94** (Scheme 31).

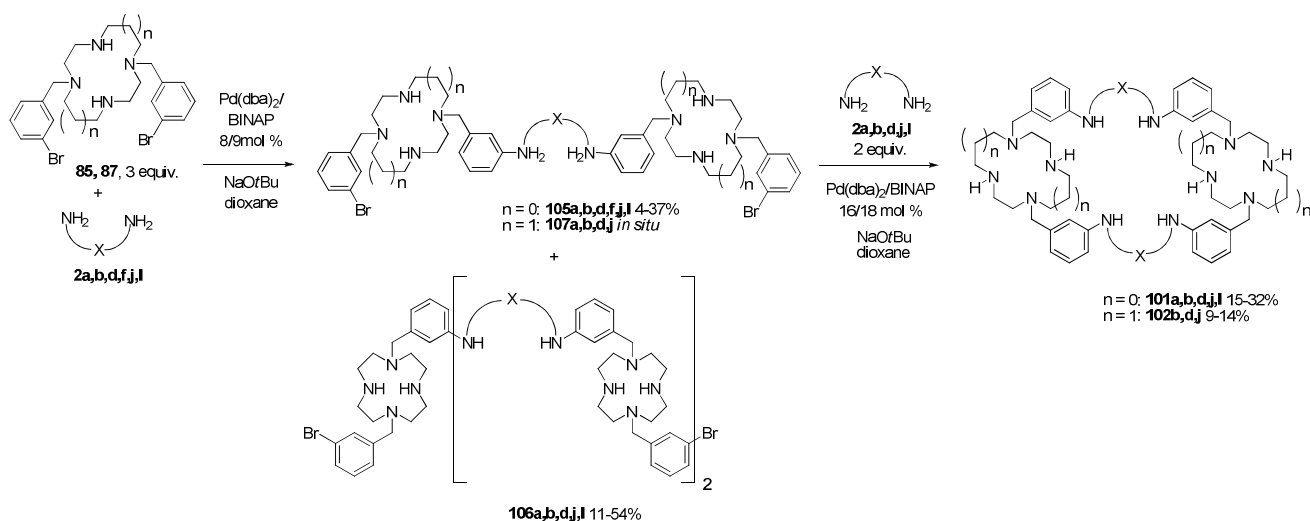

Scheme 32

Route B which employed *in situ* formed bis(polyamine) derivatives **108** and **109** was more general and sometimes provided higher yields of the cyclodimers **93** and **94** (Scheme 33). Under these conditions, we synthesized several novel cyclam-containing cyclodimers **102** which were not observed as by-products in the synthesis of corresponding macrobicycles **94** (Scheme 31). Our attempts to prepare cyclodimers comprising pyridine units using both methods A and B were unsuccessful. The target compounds were detected in the reaction mixtures by NMR and mass spectroscopy but their isolation was impossible.

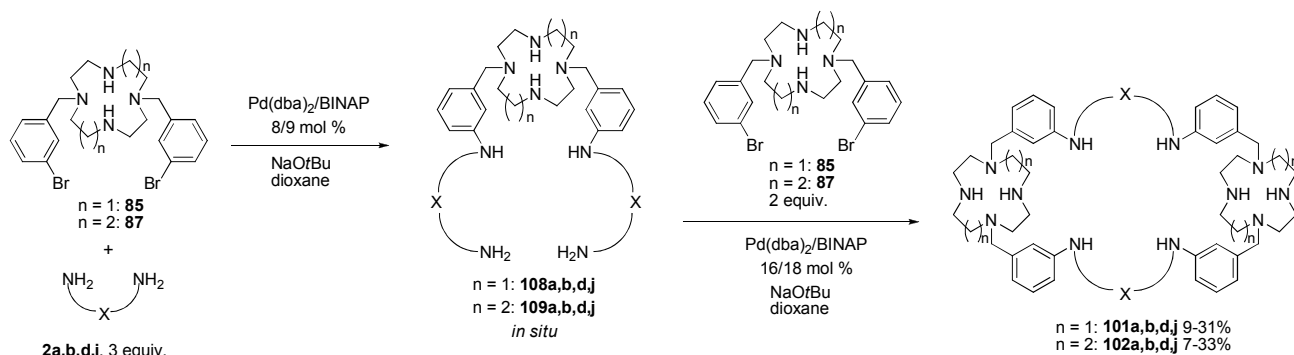

Scheme 33

6.2. Macropolycycles comprising azacrown ethers cavities

Macrobicyclic compounds containing two azacrown moieties are known for about 20 years. Nucleophilic substitution reactions is a key step in general approaches to bicyclic cryptands and more sophisticated polycyclic supercryptands and macropolycycles with isolated cycles were developed by Izatt *et al*^{177, 178} and Krakowiak¹⁷⁹. Many useful ligands contain two symmetrically arranged azacrown moieties attached to different spacers, such as aromatic compound,^{180,181} metallocenes,¹⁸² porphyrin¹⁸³ or simple functionalized alkane.¹⁸⁴ Two identical azacrown ether moieties are often present in the reported polycyclic molecules. Azacrown ethers can be attached to calixarenes as substituents¹⁸⁵ or form calixcrowns.^{186–188} The interest to bis(azacrown) ethers origins from their original coordination properties which were used in different technological applications. For example, they were tested as photosensors for K⁺, Cs⁺, Ag⁺, Ba²⁺ ions.^{187–189}

In our method, the synthesis of bis(azacrown) compounds started from the reaction of 1-aza-15-crown-5 **110** or 1-aza-18-crown-6 **111** with 1 equiv. of 3,5-dibromobenzyl bromide in boiling acetonitrile in the presence of K₂CO₃ as a base. Under these conditions, *N*-(3,5-dibromobenzyl) derivatives **112** and **113** were obtained in 95% and 90% yields (Scheme 34).

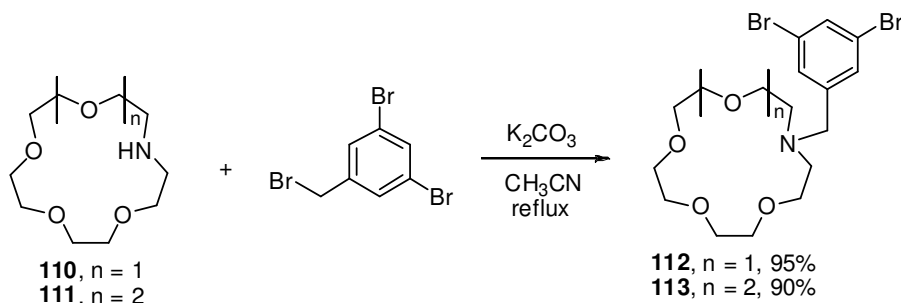

Scheme 34

These compounds reacted with equimolar amounts of di- and polyamines in the presence of Pd catalyst leading to macrobicyclic compounds **114** and **115** in yields up to 56% (Scheme 35).^{190,191}

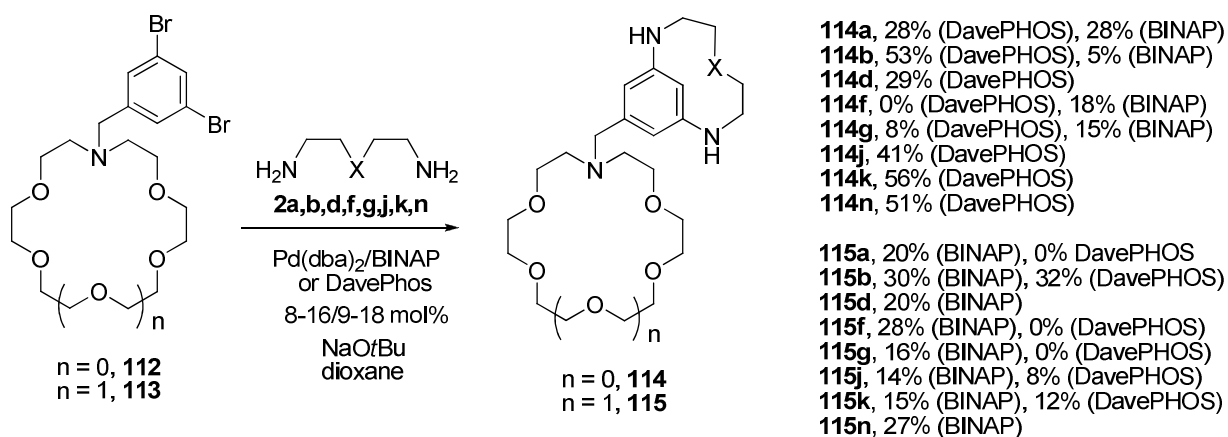

Scheme 35

The product yield was noted to be dependent on the nature of polyamines and on the size of the parent azacrown ether. The best yields were obtained in the reactions of 1-aza-15-crown-5 derivative **112** with diamines. Next, we optimized the product yields using different ligands. For the reactions of compound **112**

with diamines, Pd(dba)₂/DavePHOS system was preferable, whereas BINAP was found to be efficient with polyamines as well as in the amination of 1-aza-18-crown-6 derivative **113** with all di- and polyamines.

Cryptands **122** were prepared by analogous way. 1,7-Diaza-4,10,13-trioxacyclopentadecane (**116**) and 1,10-diaza-4,7,13,16-tetraoxacyclooctadecane (**117**) reacted with 3- and 4-bromobenzyl bromides to form bis(bromobenzyl) derivatives **118–121** in practically quantitative yields (Scheme 36).

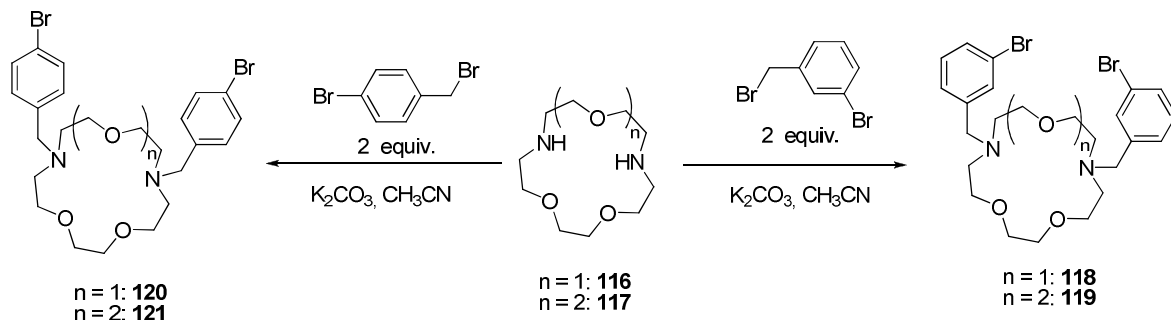

Scheme 36

The compound **118** reacted with di- and polyamines **2a,b,d,f,g,j,k–n** giving macrobicycles **122** and macrotricycles **123** in good yields. Target cryptands **122** were obtained in yields up to 38% (Scheme 37).

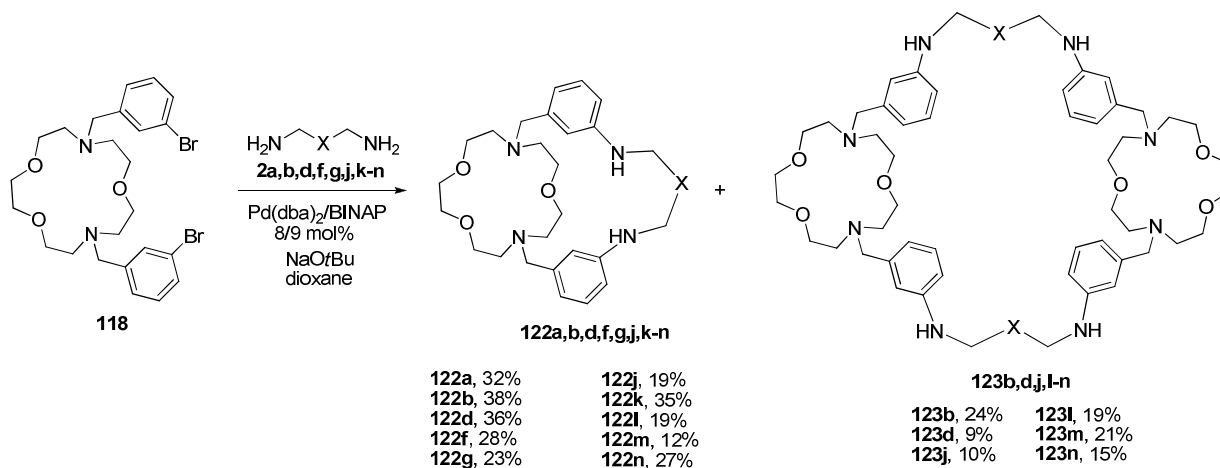

Scheme 37

To our surprise, Pd-catalyzed amination of bis(4-bromobenzyl) derivative **120** with polyamines (Scheme 38) proceeded in the presence of higher catalyst loading (16 mol%) and led to lower yields of macrobicycles **124** and macrotricyclic cyclodimers **125**. The products yields depended on the chain length of the diamine used and on the nature of the phosphine ligand. The best yield of target macrobicyclic **124** (18%) was obtained in the reaction with dioxadiazine **2j**.

Much better yields of target cryptands were obtained in the reactions of bis(bromobenzyl) derivatives **119** and **121** which contained a larger macrocycle (Scheme 39). The product yield was 35% in the reaction of 3-bromobenzyl derivative **119** with trioxadiazine **2b**, and with dioxadiazine **2j** it reached even 57%, the best one in the reactions described in this review. 4-Bromobenzyl derivative **121** gave the corresponding compounds in 36% and 27% yields.

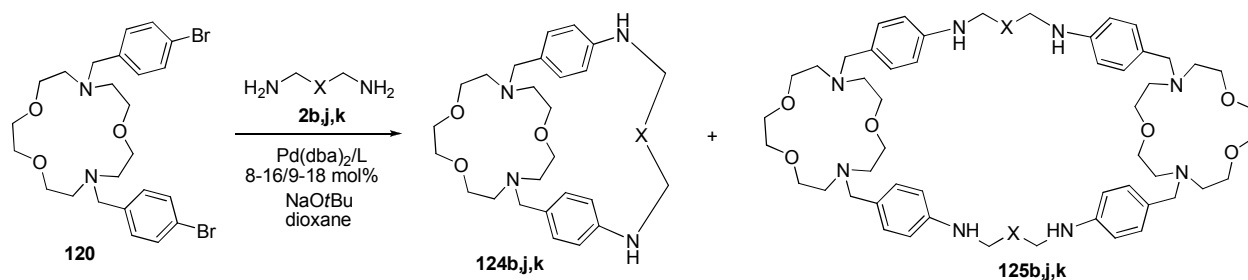

	124	125
b : Pd(dba) ₂ /BINAP 8/9 mol%:	5%;	10%
b : Pd(dba) ₂ /DavePHOS 8/9 mol%:	4%;	10%
b : Pd(dba) ₂ /BINAP 16/18 mol%:	10%;	19%
j : Pd(dba) ₂ /BINAP 16/18 mol%:	18%;	31%
k : Pd(dba) ₂ /BINAP 16/18 mol%:	10%;	10%

Scheme 38

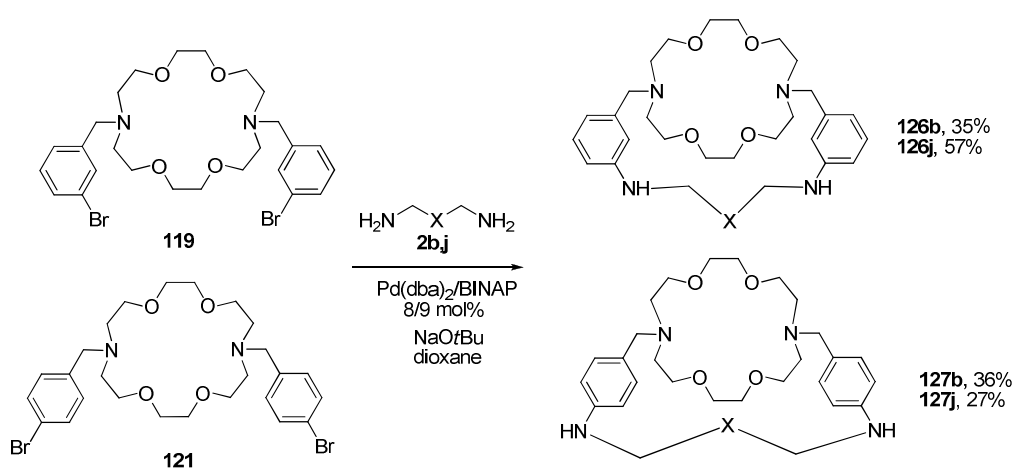

Scheme 39

6.3. Macrocycles based on disubstituted biphenyl and naphthalene

We decided to synthesize the molecules with several haloaryl substituents on the basis of polyamines and polyazamacrocycles in view of the following catalytic amination of such compounds which would lead to macropolycyclic derivatives. The first approach was the exhaustive tetraarylation of linear diamines **2b,j,k-n** with 6–8 equiv. of 2,7-dibromonaphthalene, 4,4'- and 3,3'-dibromobiphenyl (Scheme 40).

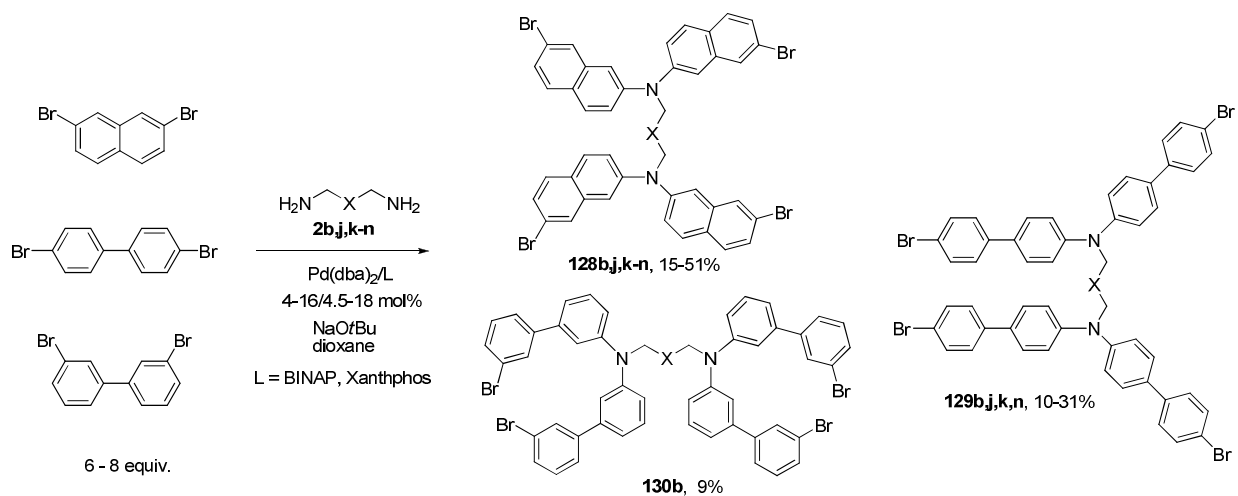

Scheme 40

BINAP was used as ligand in the reactions with dibromobiphenyls whereas Xanthphos was employed with dibromonaphthalene. The best yields of the tetrakis(bromoaryl)diamines were obtained with 2,7-dibromonaphthalene (up to 51% for **128**), 4,4'-dibromobiphenyl provided more modest results (up to 31% for **129**), while 3,3'-dibromobiphenyl was much less active and gave 9% yield of **130b**. Moreover, longer diamines were more reactive in the tetraarylation reaction than the shortest **2l,m**.

Compounds **128** and **129** were reacted with 2 equiv. of diamines **2b,j,k**, in the presence of Pd catalyst. The reactions of **128** were catalyzed by Pd(0)/DavePHOS, whereas Pd(0)/BINAP catalytic system was used in the reactions of **129**. Two regioisomers of macrobicycles **131** were obtained in the studied reactions of tetranaphthyl derivatives **128** with yields up to 17% (Scheme 41).

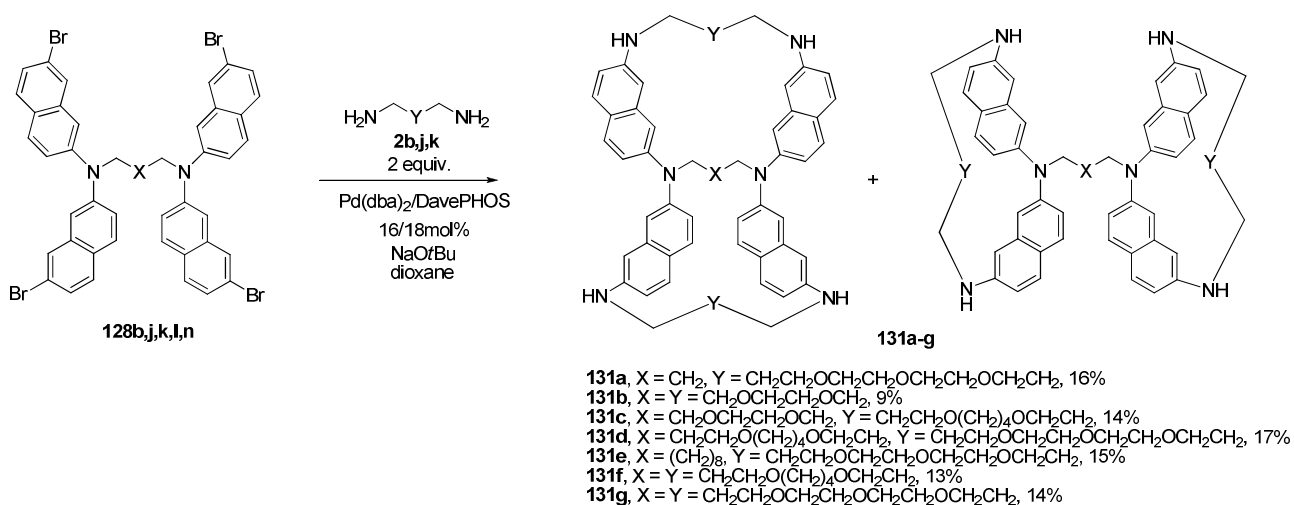

Scheme 41

The reactions of tetrabiphenyl derivatives **129** provided only one isomer of macrobicycles **132** because of significant difference in the distances between adjacent bromine atoms in this compound (Scheme 42). However, macrobicycles **132** were isolated only in 6–7% yields.

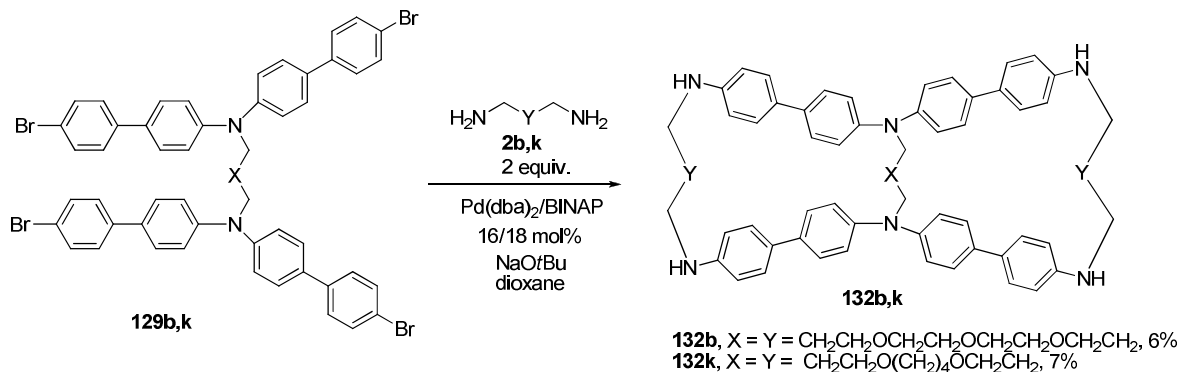

Scheme 42

Aromatic amines incorporated into macrocyclic rings can be also alkylated with 3-bromobenzyl bromide. Thus macrocycles **17** and **24** gave bromobenzyl derivatives **133** and **134** in yields near to quantitative (Scheme 43).

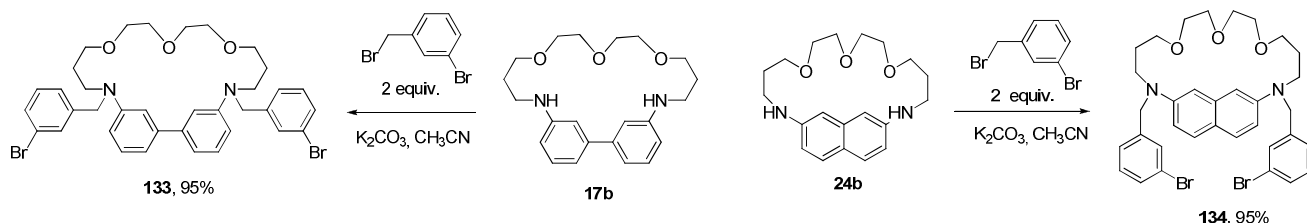

Scheme 43

Macrocycles **133** and **134** were reacted with linear di- and polyamines **2** to produce target macrobicycles **135** and **136**. Here again a pronounced dependence of the yields of these products on the chain length of polyamines and on the structure of parent macrocycles was observed (Scheme 44). The best product yield was obtained in the reaction of the compound **133** with triamine **2d** (30%). Compound **134** gave also high yields of macrobicycles in the reaction with tri- and dioxadiazines **2b,j** (35, 33%). In general, the reactions of the naphthalene-based dibromide **134** gave better results than the biphenyl-based compound **133**.

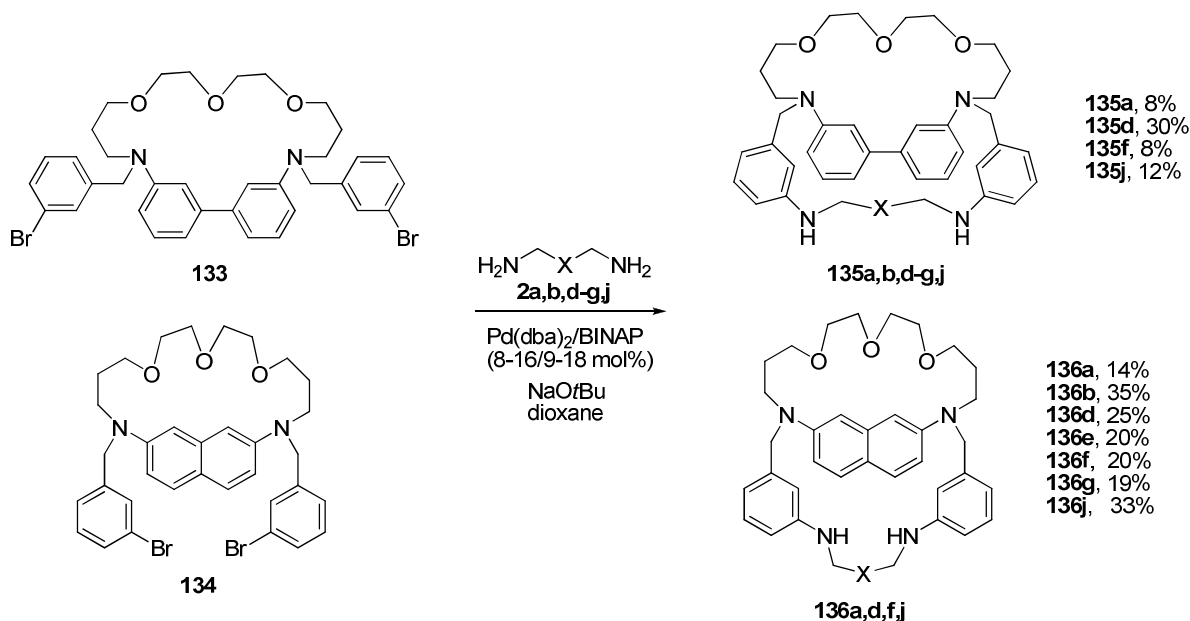

Scheme 44

7. Applications of macrocycles for metal ions detection

Reported macrocycles are of potential interest as extracting reagents for toxic and radioactive metal ions and can be employed for elaboration of new sorbents. Moreover, Pd-catalyzed amination is promising synthetic approach to design novel chemosensors. Indeed, photoactive chemosensors often contain an aromatic moiety as a signaling subunit. Polyamines or oxadiazines are known to be efficient receptor moieties for cations or anions. Pd-catalyzed C(sp²)-N bond formation reaction is a convenient synthetic method to link directly receptor and signaling subunits. The presence of the signaling subunit in a close proximity to the analyte binding moiety could induce the efficient signaling response on the analyte binding. In order to illustrate this approach, we developed efficient colorimetric sensors bearing anthraquinone signaling unit. Colorimetric sensors are of special interest for express methods of analysis since they allow a so-called “naked-eye” detection and may be used as dip-stick sensors.

Pd-catalyzed amination reaction is a very efficient method for the synthesis of polyamines containing 1,5- and 1,8-diaminoanthraquinone moieties.⁹⁹ This reaction can also be used for the synthesis of macrocyclic derivatives comprising anthraquinone moiety into the macrocyclic ring, as it was shown above. We have assumed that these polyazamacrocyclic compounds would be a good universal backbone for the development of selective sensors for target analytes. In such compounds, the structural change of receptor subunit is simple and can be done by modification of the polyaza chain or by the attachment of additional coordination groups to nitrogen atoms of the macrocycle.

Initially, the parent compound **32h** was prepared according to the Buchwald-Hartwig reaction (Scheme 45) and chromoionophore **32h** showed a good selectivity for Cu(II) and Al(III) ions in H₂O-MeOH media (Fig. 4).

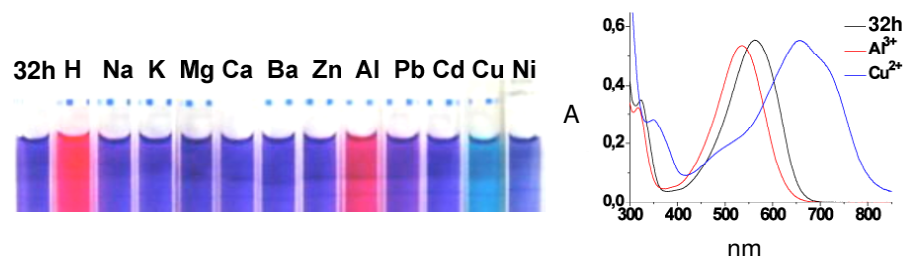
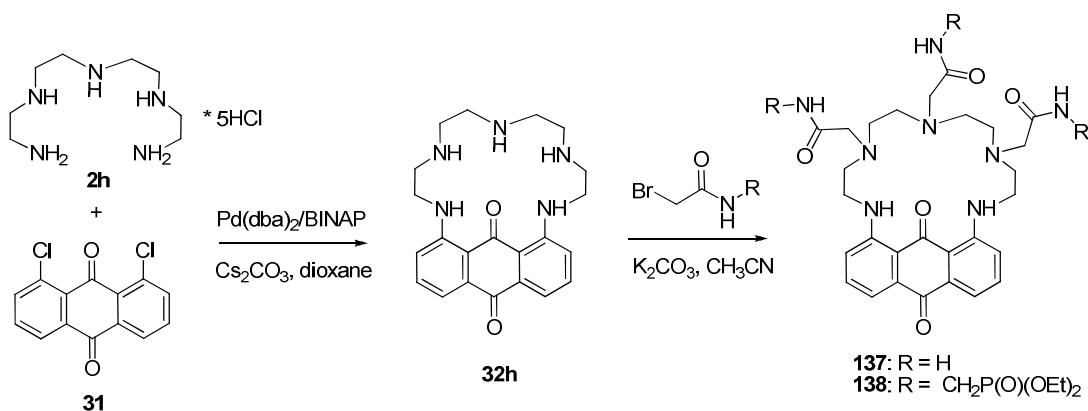

Figure 4

To improve the affinity of the macrocyclic ligand to heavy metals, a simple structural modification of macrocycle **32h** was done by the introduction of pendant arms possessing additional metal binding sites. Triamide derivative **137** was synthesized by the reaction of the parent macrocycle **32h** with bromoacetamide (Scheme 45). Low solubility of the tri-amide **137** in water and in the most of protic solvents (MeOH, EtOH) limited the applications of this compound. However, the colour changes induced by metal analytes in DMSO/H₂O solution (1:1) were sufficient for Cu(II) and Pb(II) ions detection (Figure 5).

Another sensor **138** which is efficient in water was obtained by the introduction of three diethoxyphosphoryl groups (Scheme 45).¹⁹²



Scheme 45

High stability of the corresponding lead complex allows to observe notable color change after the addition of only 1 equiv. of the metal salt (Figure 6). The naked-eye detection limit of Pb(II) in solution is as low as 2–3 ppm (10–15 μM). Using a conventional spectrometer, the detection limit is decreased to 21 ppb

(0.1 μM). This low detection limit is due to both a high stability of Pb(II) complex and a high value of the molar absorption coefficient ($\epsilon=4.9 \times 10^3 \text{ Lmol}^{-1}\text{cm}^{-1}$) at 571 nm. Chemoselectivity in the analyte detection of this compound is enough high, and only Ni(II) and Cd(II) ions in 100-fold excess hinder the detection of Pb(II) ions.

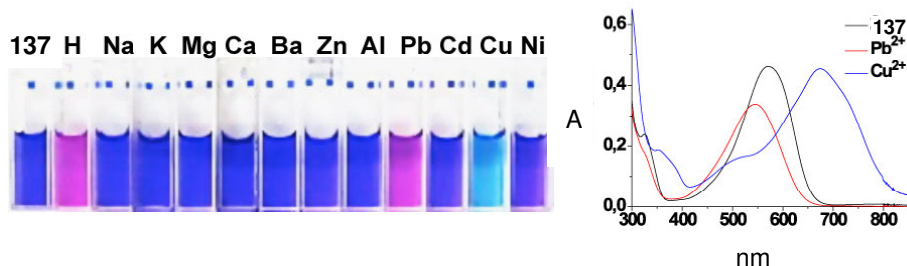

Figure 5

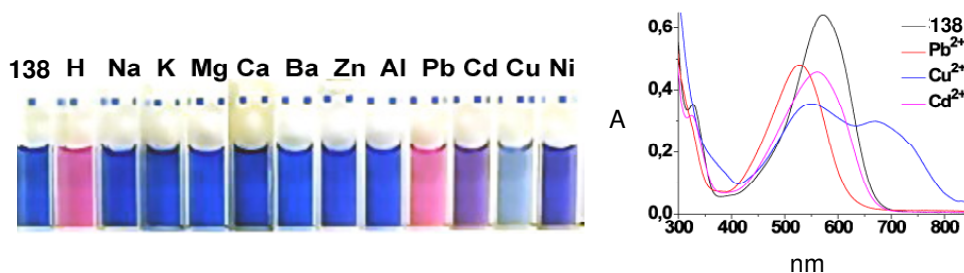

Figure 6

8. Conclusions

The results overviewed in this chapter underline the importance of the Pd-catalyzed amination reaction in the synthesis of novel nitrogen- and oxygen-containing macrocycles comprising aromatic moieties. Indeed, this reaction allows to introduce C(sp²)-N bond into macrocyclic molecules. The scope of the reaction is obviously large what makes a variety of macrocycles, available through this method, almost inexhaustive. Varying the starting aromatic dihalides as well as di- and polyamines, we developed conditions for the synthesis of macrocycles, cyclic dimers, macropolycyclic compounds and cryptands. The dependence of the macrocyclization reaction on the nature of starting dihaloarenes and polyamines is quite pronounced and limitations of the proposed method are demonstrated.

Acknowledgments

This work was supported by RFBR grants 09-03-00735, 08-03-00628, by the Russian Academy of Sciences program P-8 "Development of the methods for the synthesis of new chemicals and creation of new materials", CNRS (LIA LAMREM) and by the ARCUS program "Bourgogne-Russie".

References

1. Bradshaw, J. S.; Krakowiak, K. E.; Izatt, R. M. *Aza-Crown Macrocycles*; Wiley: New York, 1993.
2. Parker, D. *Macrocyclic Synthesis*; Oxford University Press, 1996.

3. Higson, S.; Davis, F. *Macrocycles: Construction, Chemistry and Nanotechnology Applications*; Wiley: Weinheim, 2011.
4. *Macrocyclic Chemistry: Current Trends and Future Perspectives*; Gloe, K., Ed.; Springer: Dordrecht, 2005.
5. Burguette, M. I.; Escuder, B.; Garcia-Espana, E.; Luis, S. V.; Miravet, J. F. *Tetrahedron* **2002**, *58*, 2839.
6. Militopoulou, M.; Tsiakopoulos, N.; Chochos, C.; Magoulas, G. *Tetrahedron Lett.* **2002**, *43*, 2593.
7. Favre-Reguillon, A.; Segat-Dioury, F.; Nait-Bouda, L.; Cosma, C.; Siaugue, J.-M.; Foos, J.; Guy, A. *Synlett* **2000**, 868.
8. Ray, J. K.; Haldar, M. K.; Gupta, S.; Kar, G. K. *Tetrahedron* **2000**, *56*, 909.
9. *Modern Supramolecular Chemistry: Strategies for Macrocyclic Synthesis*; Diderich, F.; Stang, P.; Tykwinski, R. R., Eds.; Wiley: Weinheim, 2008.
10. Kulikov, O. V.; Pavlovsky, V. I.; Andronati, S. A. *Chem. Heterocycl. Compd.* **2005**, *41*, 1447.
11. Van de Weghe, P.; Eustache, J. *Curr. Top. Med. Chem.* **2005**, *5*, 1495.
12. Chaudhary, A.; Singh, R. V. *Rev. Inorg. Chem.* **2008**, *28*, 35.
13. Chartres, J. D.; Davies, M. S.; Lindoy, L. F.; Meehan, G. V.; Wei, G. *Inorg. Chem. Commun.* **2006**, *9*, 751.
14. Elwahy, A. H. M.; Abbas, A. A. *J. Heterocycl. Chem.* **2008**, *45*, 1.
15. Alp, H.; Gök, H. Z.; Kantekin, H.; Ocak, Ü. *J. Hazardous Materials* **2008**, *159*, 519.
16. Galaup, C.; Couchet, J.-M.; Bedel, S.; Tisnès, P.; Picard, C. *J. Org. Chem.* **2005**, *70*, 2274.
17. Ibrahim, Y. A. *J. Mol. Cat. A: Chemical* **2006**, *254*, 43.
18. Oueslati, I. *Tetrahedron* **2007**, *63*, 10840.
19. Sibert, J. W.; Hundt, G. R.; Sargent, A. L.; Lynch, V. *Tetrahedron* **2005**, *61*, 12350.
20. Yang, B. H.; Buchwald, S. L. *J. Organomet. Chem.* **1999**, *576*, 125.
21. Hartwig, J. F. *Angew. Chem. Int. Ed.* **1998**, *37*, 2046.
22. Wolfe, J. P.; Buchwald, S. L. *J. Org. Chem.* **2000**, *65*, 1144.
23. Hartwig, J. F. *Synlett* **1997**, 329.
24. Hartwig, J. F.; Paul, F. *J. Am. Chem. Soc.* **1995**, *117*, 5373.
25. Louie, J.; Paul, F.; Hartwig, J. F. *Organometallics* **1996**, *15*, 2794.
26. Hartwig, J. F.; Richards, S.; Baranano, D.; Paul, F. *J. Am. Chem. Soc.* **1996**, *118*, 3626.
27. Widenhoefer, R. A.; Buchwald, S. L. *Organometallics* **1996**, *15*, 2755.
28. Driver, M. S.; Hartwig, J. F. *J. Am. Chem. Soc.* **1997**, *119*, 8232.
29. Wolfe, J. P.; Wagaw, S.; Marcoux, J.-F.; Buchwald, S. L. *Acc. Chem. Res.* **1998**, *31*, 805.
30. Zhong, H. A.; Widenhoefer, R. A. *Inorg. Chem.* **1997**, *36*, 2610.
31. Widenhoefer, R. A.; Buchwald, S. L. *Organometallics* **1996**, *15*, 3534.
32. de Silva, A. P.; Gunaratne, H. Q. N.; Gunnlaugsson, T.; Huxley, A. J. M.; McCoy, C. P.; Rademacher, J. T.; Rice, T. E. *Chem. Rev.* **1997**, *97*, 1515.
33. Callan, J. F.; de Silva, A. P.; Magri, D. C. *Tetrahedron* **2005**, *61*, 8551.
34. Rurack, K.; Resch-Genger, U. *Chem. Soc. Rev.* **2002**, *31*, 116.
35. Cosnarda, F.; Wintgens, V. *Tetrahedron Lett.* **1998**, *39*, 2751.
36. de Silva, A. P.; Gunaratne, H. Q. N.; Gunnlaugsson, T.; Nieuwenhuizen, M. *Chem. Commun.* **1996**, 1967.
37. He, H.; Mortellaro, M. A.; Leiner, M. J. P.; Fraatz, R. J.; Tusa, J. K. *J. Am. Chem. Soc.* **2003**, *125*, 1468.
38. Fery-Forgues, S.; Le Bris, M.-T.; Guette, J.-P.; Valeu, B. *J. Phys. Chem.* **1988**, *98*, 6233.
39. Rurack, K.; Danel, A.; Rotkiewicz, K.; Grabka, D.; Spieles, M.; Rettig, W. *Org. Lett.* **2002**, 4647.
40. Witulski, B.; Weber, M.; Bergstrasser, U.; Desvergne, J.-P.; Bassani, D. M.; Bouas-Laurent, H. *Org. Lett.* **2001**, *3*, 1467.
41. Gouloumis, A.; Lawson, R. G.; Vasquez, P.; Echegoyen, L.; Torres, T. *Tetrahedron* **2002**, *58*, 961.
42. Gunnlaugsson, T.; Nieuwenhuizen, M.; Richard, M.; Thoss, V. *J. Chem. Soc., Perkin Trans. 2* **2002**, *2*, 141.
43. Ambrosi, G.; Formica, M.; Fusi, V.; Giorgi, L.; Macedi, E.; Micheloni, M.; Paoli, P.; Pontellini, R.; Rossi, P. *Inorg. Chem.* **2010**, *49*, 9940.

44. De Wall, S. L.; Meadows, E. S.; Barbour, L. J.; Gokel, G. W. *J. Chem. Soc., Chem. Commun.* **1999**, 1553.
45. Meadows, E. S.; De Wall, S. L.; Barbour, L. J.; Gokel, G. W. *J. Chem. Soc., Chem. Commun.* **1999**, 1555.
46. Kubo, K.; Yamamoto, E.; Sakurai, T. *Heterocycles* **1998**, *48*, 2133.
47. Koulov, A. V.; Mahoney, J. M.; Smith, B. D. *Org. Biomol. Chem.* **2003**, *1*, 1467.
48. Vetrichelvan, M.; Lai, Y.-H.; Mok, K. F. *Dalton Trans.* **2003**, 295.
49. Borisova, N. E.; Reshetova, M. D.; Ustynyuk, Yu. A. *Chem. Rev.* **2007**, *107*, 46.
50. Ambrosi, G.; Formica, M.; Fusi, V.; Giorgi, L.; Guerri, A.; Micheloni, M.; Paoli, P.; Pontellini, R.; Rossi, P. *Inorg. Chem.* **2007**, *46*, 4737.
51. Ambrosi, G.; Formica, M.; Fusi, V.; Giorgi, L.; Macedi, E.; Micheloni, M.; Paoli, P.; Rossi, P. *Inorg. Chem.* **2009**, *48*, 10424.
52. Guilard, R.; Bessmertnykh, A. G.; Beletskaya, I. P. *Tetrahedron Lett.* **1997**, *38*, 2287.
53. Guilard, R.; Bessmertnykh, A. G.; Beletskaya, I. P. *Synlett* **1999**, 1459.
54. Beletskaya, I. P.; Bessmertnykh, A. G.; Averin, A. D.; Denat, F.; Guilard, R. *Eur. J. Org. Chem.* **2005**, 261.
55. Beletskaya, I. P.; Averin, A. D.; Borisenko, A. A.; Denat, F.; Guilard, R. *Tetrahedron Lett.* **2003**, *44*, 1433.
56. Averin, A. D.; Shukhaev, A. V.; Buryak, A. K.; Beletskaya, I. P. *Russ. J. Org. Chem.* **2009**, *45*, 1368.
57. Averin, A. D.; Shukhaev, A. V.; Golub, S. L.; Buryak, A. K.; Beletskaya, I. P. *Synthesis* **2007**, 2995.
58. Kohama, H.; Yoshinaga, M.; Ishizu, K. *Bull. Chem. Soc. Jpn.* **1980**, *53*, 3707.
59. Reinhoudt, D. N.; de Jong, F.; van de Vondervoort, E. M. *Tetrahedron* **1981**, *37*, 1753.
60. Reinhoudt, D. N.; de Jong, F.; van de Vondervoort, E. M. *Tetrahedron* **1981**, *37*, 1985.
61. Rebek Jr, J. *Acc. Chem. Res.* **1984**, *17*, 258.
62. Rebek Jr, J.; Costello, T.; Marshall, L.; Wattlely, R.; Gadwood, R. C.; Onan, K. *J. Am. Chem. Soc.* **1985**, *107*, 7481.
63. Rebek Jr, J.; Wattlely, R. V.; Costello, T.; Gadwood, R.; Marshall, L. *J. Am. Chem. Soc.* **1980**, *102*, 7398.
64. Gaviña, F.; Luis, S. V.; Costero, A. M.; Burguete, M. I.; Rebek Jr, J. *J. Am. Chem. Soc.* **1988**, *110*, 7140.
65. Burguete, M. I.; Diaz, P.; Garcia-España, E.; Luis, S. V.; Miravet, J. F.; Querol, M.; Ramirez, J. A. *Chem. Commun.* **1999**, 649.
66. Pearson, D. P. J.; Leigh, S. J.; Sutherland, I. O. *J. Chem. Soc., Perkin Trans. 1* **1979**, 3113.
67. Choi, K.; Hamilton, A. D. *J. Am. Chem. Soc.* **2003**, *125*, 10241.
68. Kuhnert, N.; Straßnig, K.; Lopez-Periago, A. M. *Tetrahedron: Asymmetry* **2002**, *13*, 123.
69. Kuhnert, N.; Rossignolo, G. M.; Lopez-Periago, A. M. *Org. Biomol. Chem.* **2003**, *1*, 1157.
70. Averin, A. D.; Uglov, A. N.; Buryak, A. K.; Beletskaya, I. P. *Macroheterocycles* **2009**, *2*, 275.
71. Averin, A. D.; Uglov, A. N.; Buryak, A. K.; Beletskaya, I. P. *Mendeleev Commun.* **2010**, *20*, 1.
72. Uglov, A. N.; Averin, A. D.; Buryak, A. K.; Beletskaya, I. P. *Arkivoc* **2011**, *viii*, 99.
73. Gallant, A. J.; Yun, M.; Sauer, M.; Yeung, C. S.; MacLachlan, M. J. *Org. Lett.* **2005**, *7*, 4827.
74. Sharghi, H.; Zare, A. *Synthesis* **2006**, 999.
75. Khoshbin, M. S.; Ovchinnikov, M. V.; Khalid, S.; Mirkin, C. A.; Stern, C.; Zakharov, L. N.; Rheingold, A. L. *Chem. Asian J.* **2006**, *1*, 686.
76. Eshgi, H.; Mirzaei, M.; Mehdi, E.; Shahry, H. *J. Chem. Res.* **2007**, 272.
77. Patra, G. K.; Datta, D. *Ind. J. Chem. Sect. A* **2000**, *39*, 480.
78. Rasadkina, E. N.; Slitikov, P. V.; Evdokimenkova, Yu. B.; Nifant'ev, E. E. *Russ. J. Gen. Chem.* **2003**, *73*, 1208.
79. Yamato, T.; Okabe, R.; Miyamoto, S.; Miyazaki, M. *J. Chem. Res.* **2006**, 593.
80. Tran, H.-A.; Ashram, M.; Mizyed, S.; Thompson, D. W.; Georghiou, P. E. *J. Incl. Phen. Macrocyclic Chem.* **2008**, *60*, 43.
81. Lukyanenko, N. G.; Lyapunov, A. Yu.; Kirichenko, T. I.; Botoshansky, M. M.; Simonov, Yu. A.; Fonari, M. S. *Tetrahedron Lett.* **2005**, *46*, 2109.
82. Kieran, A. L.; Pascu, S. I.; Jarosson, T.; Maxwell, J.; Sanders, J. K. M. *Chem. Commun.* **2005**, 1842.

83. Qin, H.; He, Y.; Qing, G.; Hu, C.; Yang, X. *Tetrahedron: Assymetry* **2006**, *17*, 2143.
84. Alfonso, I.; Burguete, M. I.; Galindo, F.; Luis, S. V.; Vigara, L. *J. Org. Chem.* **2007**, *72*, 7947.
85. Averin, A. D.; Uglov, A. N.; Beletskaya, I. P. *Chem. Lett.* **2008**, *37*, 1074.
86. Granzhan, A.; Teulade-Fichou, M.-P. *Chem. Eur. J.* **2009**, *15*, 1314.
87. Ballardini, R.; Balzani, V.; Credi, A.; Gandolfi, M. T.; Marquis, D.; Perez-Garcia, L.; Stoddart, J. F. *Eur. J. Org. Chem.* **1998**, 81.
88. Muathen, H. A.; Aloweiny, N. A. M.; Elwahy, A. H. M. *J. Heterocycl. Chem.* **2009**, *46*, 656.
89. Miki, K.; Fujita, M.; Inoue, Y.; Senda, Y.; Kowada, T.; Ohe, K. *J. Org. Chem.* **2010**, *75*, 3537.
90. Chen, S.; Yan, Q.; Li, T.; Zhao, D. *Org. Lett.* **2010**, *12*, 4784.
91. Kadarkaraisamy, M.; Sykes, A. G. *Inorg. Chem.* **2006**, *45*, 779.
92. Kadarkaraisamy, M.; Caple, G.; Gorden, A. R.; Scurle, M. A.; Sykes, A. G. *Inorg. Chem.* **2008**, *47*, 11644.
93. Chen, Zh.; Schall, O. F.; Alcalá, M.; Li, Y.; Gokel, G. W.; Echegoyen, L. *J. Am. Chem. Soc.* **1992**, *114*, 444.
94. de Mendoza, J.; Hafez, Y.; Torres, T. *J. Org. Chem.* **1994**, *59*, 3814.
95. Su, Y.-S.; Chen, C.-F. *Org. Lett.* **2010**, *12*, 1888.
96. Granzhan, A.; Largy, E.; Saettel, N.; Teulade-Fichou, M.-P. *Chem. Eur. J.* **2010**, *16*, 878.
97. Beletskaya, I. P.; Averin, A. D.; Bessmertnykh, A. G.; Guillard, R. *Tetrahedron Lett.* **2001**, *42*, 4983.
98. Beletskaya, I. P.; Averin, A. D.; Bessmertnykh, A. G.; Guillard, R. *Tetrahedron Lett.* **2001**, *42*, 4987.
99. Beletskaya, I. P.; Bessmertnykh, A. G.; Averin, A. D.; Denat, F.; Guillard, R. *Eur. J. Org. Chem.* **2005**, 281.
100. Ranyuk, E. R.; Averin, A. D.; Beletskaya, I. P. *Adv. Synth. Catal.* **2010**, *352*, 2299.
101. Averin, A. D.; Ranyuk, E. R.; Buryak, A. K.; Beletskaya, I. P. *Chem. Lett.* **2008**, *37*, 161.
102. Averin, A. D.; Ranyuk, E. R.; Buryak, A. K.; Beletskaya, I. P. *Russ. J. Org. Chem.* **2008**, *44*, 1694.
103. Stetter, H.; Frank, W.; Mertens, R. *Tetrahedron* **1981**, *37*, 767.
104. Costa, J.; Delgado, R. *Inorg. Chem.* **1993**, *32*, 5257.
105. Delgado, R.; Quintino, S.; Teixeira, M.; Zhang, A. *J. Chem. Soc., Dalton Trans.* **1996**, 55.
106. Felix, V.; Costa, J.; Delgado, R.; Drew, M. G. B.; Duarte, M. T.; Resende, C. *J. Chem. Soc., Dalton Trans.* **2001**, 1462.
107. Kim, W. D.; Hrcir, D. C.; Kiefer, G. E.; Sherry, A. D. *Inorg. Chem.* **1995**, *34*, 222.
108. Aime, S.; Botta, M.; Crich, S.; Giovenzana, G. B.; Jommi, G.; Pagliarin, R.; Sisti, M. *Inorg. Chem.* **1997**, *36*, 2992.
109. Favre-Reguillon, A.; Segat-Dioury, F.; Nait-Bouda, L.; Cosma, C.; Siaugue, J.-M.; Foos, J.; Guy, A. *Synlett* **2000**, 868.
110. Siaugue, J.-M.; Favre-Reguillon, A.; Dioury, F.; Plancque, G.; Foos, J.; Madic, C.; Moulin, C.; Guy, A. *Eur. J. Inorg. Chem.* **2003**, 2834.
111. Herrera, A. M.; Staples, R. J.; Kryatov, S. V.; Nazarenko, A. Y.; Rybak-Akimova, E. V. *J. Chem. Soc., Dalton Trans.* **2003**, 846.
112. Herrera, A. M.; Kalayda, G. V.; Disch, J. S.; Wilkstrom, J. P.; Korendovych, I. V.; Staples, R. J.; Campana, C. F.; Nazarenko, A. Y.; Haas, T. E.; Rybak-Akimova, E. V. *J. Chem. Soc., Dalton Trans.* **2003**, 4482.
113. Pandey, G. K.; Srivastava, S.; Pandey, O. P.; Sengupta, S. K. *Indian J. Chem. Sect. A* **1998**, 447.
114. Denat, F.; Lacour, S.; Brandes, S.; Guillard, R. *Tetrahedron Lett.* **1997**, *38*, 4417.
115. Brandes, S.; Denat, F.; Lacour, S.; Rabiet, F.; Barbette, F.; Pullumbi, P.; Guillard, R. *Eur. J. Org. Chem.* **1998**, 2349.
116. Bazzicalupi, C.; Bencini, A.; Bianchi, A.; Danesi, A.; Faggi, E.; Giorgi, C.; Santarelli, S.; Valtancoli, B. *Coord. Chem. Rev.* **2008**, *252*, 1052.
117. Luening, U. *Liebigs Ann. Chem.* **1987**, 949.
118. Sessler, J. L.; Katayev, E.; Dan Pantos, G.; Scherbakov, P.; Reshetova, M. D.; Khrustalev, V. N.; Lynch, V. M.; Ustynyuk, Yu. A. *J. Am. Chem. Soc.* **2005**, *127*, 11442.
119. Beletskaya, I. P.; Averin, A. D.; Pleshkova, N. A.; Borisenko, A. A.; Serebryakova, M. V.; Denat, F.; Guillard, R. *Synlett* **2005**, 87.

120. Averin, A. D.; Ulanovskaya, O. A.; Borisenko, A. A.; Serebryakova, M. V.; Beletskaya, I. P. *Tetrahedron Lett.* **2006**, *47*, 2691.
121. Averin, A. D.; Ulanovskaya, O. A.; Pleshkova, N. A.; Borisenko, A. A.; Beletskaya, I. P. *Collect. Czech. Chem. Commun.* **2007**, *72*, 785.
122. Beletskaya, I. P.; Averin, A. D.; Ulanovskaya, O. A.; Fedotenko, I. A.; Borisenko, A. A.; Serebryakova, M. V.; Denat, F.; Guillard, R. *Chem. Lett.* **2005**, *34*, 1100.
123. Averin, A. D.; Ulanovskaya, O. A.; Fedotenko, I. A.; Borisenko, A. A.; Serebryakova, M. V.; Beletskaya, I. P. *Helv. Chim. Acta* **2005**, *88*, 1983.
124. Newkome, G. R.; Kiefer, G. E.; Kohli, D. K.; Xia, Y.-J.; Fronczek, F. R.; Baker, G. R. *J. Org. Chem.* **1989**, *54*, 5105.
125. Bazzicaluppi, C.; Bencini, A.; Biagini, S.; Bianchi, A.; Faggi, E.; Giorgi, C.; Marchetta, M.; Totti, F.; Valtancoli, B. *Chem. Eur. J.* **2009**, *15*, 8049.
126. Lawecka, J.; Karczmarzyk, Z.; Wolinska, E.; Branowska, D.; Rykowski, A. *Eur. J. Org. Chem.* **2010**, 4868.
127. Bencini, A.; Bianchi, A.; Giorgi, C.; Fusi, V.; Masotti, A.; Paoletti, P. *J. Org. Chem.* **2000**, *65*, 7686.
128. Baxter, P. N. W. *Chem. Eur. J.* **2002**, *8*, 5250.
129. Tian, L.-L.; Wang, C.; Dawn, S.; Smith, M. D.; Krause, J. A.; Shimizu, L. S. *J. Am. Chem. Soc.* **2009**, *131*, 17620.
130. Baxter, P. N. W. *J. Org. Chem.* **2001**, *66*, 4170.
131. Berna, J.; Goldup, S. M.; Lee, A.-L.; Leigh, D. A.; Symes, M. D.; Teobaldi, G.; Zerbetto, F. *Angew. Chem. Int Ed.* **2008**, *47*, 4392.
132. Li, X.-y.; Illigen, J.; Nieger, M.; Michel, S.; Schalley, C. A. *Chem. Eur. J.* **2003**, *9*, 1332.
133. Witulski, B. *Synlett* **1999**, 1223.
134. Subat, M.; Koenig, B. *Synthesis* **2001**, 1818.
135. Averin, A. D.; Uglov, A. N.; Buryak, A. K.; Bessmertnykh, A.; Guillard, R.; Beletskaya, I. P. *Heterocycles* **2010**, *80*, 957.
136. Freyne, E. J. E.; Willems, M.; Embrechts, W. C. J.; Van Emelen, K.; Van Brandt, S. F. A.; Rombouts, F. J. R. *PCT Int. Appl. WO 2006061415* **2006**, *Chem. Abstr.* **2006**, *145*, 83662.
137. Wang, L.-X.; Wang, D.-X.; Huang, Z.-T.; Wang, M.-X. *J. Org. Chem.* **2010**, *75*, 741.
138. Jhaumeer-Laulloo, S.; Witvrouw, M. *Ind. J. Chem.* **2000**, *39B*, 842.
139. Luecking, U.; Siemeister, G.; Schaefer, M.; Briem, H. *Ger. Offen. DE 10239042* **2004**, *Chem. Abstr.* **2004**, *140*, 235737.
140. Blanchard, S.; Ethirajulu, K.; Lee, C. H. A.; Nagaraj, H. K. M.; Poulsen, A.; Sun, E. T.; Tan, Y. L. E.; Teo, E. L.; William, A. D. *PCT Int. Appl. WO 2007058628* **2007**, *Chem. Abstr.* **2007**, *147*, 9958.
141. Averin, A. D.; Ulanovskaya, O. A.; Beletskaya, I. P. *Chem. Heterocycl. Compd.* **2008**, 1418.
142. Kobelev, S. M.; Averin, A. D.; Buryak, A. K.; Beletskaya, I. P. *Russ. J. Org. Chem.* **2010**, *46*, 1229.
143. Ranyuk, E. R.; Averin, A. D.; Buryak, A. K.; Savelyev, E. N.; Orlinson, B. S.; Novakov, I. A.; Beletskaya, I. P. *Mendeleev Comm.* **2009**, *19*, 136.
144. Ranyuk, E. R.; Averin, A. D.; Buryak, A. K.; Savelyev, E. N.; Orlinson, B. S.; Novakov, I. A.; Beletskaya, I. P. *Russ. J. Org. Chem.* **2009**, *45*, 1569.
145. Lappalainen, K.; Kolehmainen, E.; Šaman, D. *Spectrochim. Acta, Part A* **1995**, *51*, 1543.
146. Lappalainen, K.; Kolehmainen, E. *Liebigs Annalen* **1997**, 1965.
147. Gao, H.; Dias, J. R. *Croat. Chem. Acta* **1998**, *71*, 827.
148. Lappalainen, K.; Kolehmainen, E.; Kotoneva, J. *Magn. Res. Chem.* **1996**, *34*, 316.
149. Li, Y.; Dias, J. R. *Synthesis* **1997**, 425.
150. Bonar-Law, R. P.; Sanders, J. K. M. *Tetrahedron Lett.* **1993**, *34*, 1677.
151. Bonar-Law, R. P.; Sanders, J. K. M. *Tetrahedron Lett.* **1992**, *33*, 2071.
152. Gao, H.; Dias, J. R. *Eur. J. Org. Chem.* **1998**, 719.
153. Virtanen E.; Kolehmainen, E. *Eur. J. Org. Chem.* **2004**, 3385.
154. Bhattarai, K. M.; Bonar-Law, R. P.; Davis, A. P.; Murray, B. A. *J. Chem. Soc., Chem. Commun.* **1992**, 752.
155. Bonar-Law, R. P.; Davis, A. P. *J. Chem. Soc., Chem. Commun.* **1989**, 1050.
156. Babu, P.; Maitra, U. *Proc. Indian Acad. Sci. (Chem. Sci.)* **2003**, *115*, 607.

157. Maitra, U.; Bag, B. G. *J. Org. Chem.* **1994**, *59*, 6114.
158. Nair, V.; Prabhakaran, J. *Synth. Commun.* **1996**, *26*, 697.
159. Nair, V.; Prabhakaran, J.; Eigendorf, G. K. *Synth. Commun.* **1997**, *27*, 3095.
160. Averin, A. D.; Ranyuk, E. R.; Lukashev, N. V.; Beletskaya, I. P. *Chem. Eur. J.* **2005**, *11*, 1730.
161. Lukashev, N. V.; Averin, A. D.; Latyshev, G. V.; Donez, P. A.; Ranyuk, E. R.; Beletskaya, I. P. *Pol. J. Chem.* **2006**, *80*, 559.
162. Averin, A. D.; Ranyuk, E. R.; Lukashev, N. V.; Golub, S. L.; Buryak, A. K.; Beletskaya, I. P. *Tetrahedron Lett.* **2008**, *49*, 1188.
163. Averin, A. D.; Ranyuk, E. R.; Lukashev, N. V.; Buryak, A. K.; Beletskaya, I. P. *Russ. J. Org. Chem.* **2009**, *45*, 85.
164. Averin, A. D.; Uglov, A. N.; Ranyuk, E. R.; Lukashev, N. V.; Beletskaya, I. P. *Russ. J. Org. Chem.* **2009**, *45*, 283.
165. Meyer, M.; Dahaoui-Gindrey, V.; Lecomte, C.; Guillard, R. *Coord. Chem. Rev.* **1998**, *180*, 1313.
166. Barbette, F.; Rascalou, F.; Chollet, H.; Babouhot, J. L.; Denat, F.; Guillard, R. *Anal. Chim. Acta* **2004**, *502*, 179.
167. Gunnlaugsson, T.; Stomeo, F. *Org. Biomol. Chem.* **2007**, *5*, 1999.
168. Reichenbach-Klinke, R.; König, B. *J. Chem. Soc., Dalton Trans.* **2002**, 121.
169. Ritter, S. C.; Eiblmaier, M.; Michlova, V.; König, B. *Tetrahedron* **2005**, *61*, 5241.
170. Delgado, R.; Felix, V.; Lima, L. M. P.; Price, D. W. *Dalton Trans.* **2007**, 2734.
171. Valks, G. C.; McRobbie, G.; Lewis, E. A.; Hubin, T. J.; Hunter, T. M.; Sadler, P. J.; Pannecouque, C.; De Clercq, E.; Archibald, S. J. *J. Med. Chem.* **2006**, *49*, 6162.
172. Ambrosi, G.; Formica, M.; Fusi, V.; Giorgi, L.; Guerri, A.; Micheloni, M.; Paoli, P.; Pontellini, R.; Rossi, P. *Chem. Eur. J.* **2007**, *13*, 702.
173. Ambrosi, G.; Formica, M.; Fusi, V.; Giorgi, L.; Macedi, E.; Micheloni, M.; Paoli, P.; Pontellini, R.; Rossi, P. *Chem. Eur. J.* **2011**, *17*, 1670.
174. Beletskaya, I. P.; Averin, A. D.; Bessmertnykh, A. G.; Denat, F.; Guillard, R. *Tetrahedron Lett.* **2002**, *43*, 1193.
175. Rohovec, J.; Gyepes, R.; Cisarova, I.; Rudovsky, J.; Lukes, I. *Tetrahedron Lett.* **2000**, *41*, 1249.
176. Averin, A. D.; Shukhaev, A. V.; Buryak, A. V.; Denat, F.; Guillard, R.; Beletskaya, I. P. *Tetrahedron Lett.* **2008**, *49*, 3950.
177. Krakowiak, K. E.; Bradshaw, J. S.; Dalley, N. K.; Zhu, C.; Yi, G.; Curtis, J. C.; Li, D.; Izatt, R. M. *J. Org. Chem.* **1992**, *57*, 3166.
178. Bradshaw, J. S.; Krakowiak, K. E.; An, H.; Wang, T.; Zhu, C.; Izatt, R. M. *Tetrahedron Lett.* **1992**, *33*, 4871.
179. Krakowiak, K. E. *J. Incl. Phen. and Mol. Recogn.* **1997**, *29*, 283.
180. Costero, A. M.; Gil, S.; Sanchis, J.; Peransi, S.; Sanzam, V.; Williams, J. A. G. *Tetrahedron* **2004**, *60*, 6327.
181. Schmittel, M.; Ammon, H. *J. Chem. Soc., Chem. Commun.* **1995**, 687.
182. Beer, P. D.; Keefe, A. D.; Sikanyika, H.; Blackburn, C.; McAleer, J. F. *J. Chem. Soc., Dalton Trans.* **1990**, 3289.
183. Michaudet, L.; Richard, P.; Boitrel, B. *Tetrahedron Lett.* **2000**, *41*, 8289.
184. MacFarland, D. K.; Landis, C. R. *Organometallics* **1996**, *15*, 483.
185. Chen, H.; Kim, Y. S.; Lee, J.; Yoon, S. J.; Lim, D. S.; Choi, H.-J.; Koh, K. *Sensors* **2007**, *7*, 2263.
186. Lee, I.-H.; Jeon, Y.-M.; Gong, M.-S. *Synth. Metals* **2008**, *158*, 532.
187. Jeon, Y.-M.; Lim, T.-H.; Kim, J.-G.; Kim, J.-S.; Gong, M.-S. *Bull. Korean Chem. Soc.* **2007**, *28*, 816.
188. Ji, H. F.; Brown, G. M.; Dabestani, R. *Chem. Commun.* **1999**, 609.
189. Malval, J. P.; Leray, I.; Valeur, B. *New J. Chem.* **2005**, *29*, 1089.
190. Anokhin, M. V.; Averin, A. D.; Buryak, I. P.; Beletskaya, I. P. *Russ. Chem. Bull.* **2011**, 968-979.
191. Anokhin, M. V.; Averin, A. D.; Buryak, I. P.; Beletskaya, I. P. *Mendeleev Commun.* **2011**, *21*, 132.
192. Ranyuk, E.; Morkos-Douaihy, C.; Bessmertnykh, A.; Denat, F.; Averin, A.; Beletskaya, I.; Guillard, R. *Org. Lett.* **2009**, *11*, 987.

METAL-CATALYZED INTRAMOLECULAR HYDROAMINATIONS OF UNSATURATED AMINES WITH TERMINAL DOUBLE BOND - PART 1[#]

František Mathia, Peter Zálupský and Peter Szolcsányi*

Department of Organic Chemistry, Slovak University of Technology,
Radlinského 9, SK-812 37 Bratislava, Slovakia (e-mail: peter.szolcsanyi@stuba.sk)

Abstract. The two-part critical review deals with the metal-catalyzed intramolecular hydroaminations of alkenyl amines having terminal double bond. In this first part, the description of the hydroamination as well as the substrate activation via Thorpe-Ingold effect and/or gem-dialkyl/aryl-substitution is presented at the beginning. The main body summarizes the employment of known hydroamination catalysts based on group I and IIA metals, lanthanides and actinides in the direct preparation of saturated aza-heterocycles. The focus is given to the efficiency and stereoselectivity of aminocyclizations. The plausible mechanistic proposals are also presented and analogous ones are compared. The review covers the respective literature published until January 2009.

Contents

1. Introduction
 - 1.1. Hydroamination
 2. Overview of hydroamination catalysts
 - 2.1. Group I and IIA metals
 - 2.1.1. Synthesis of pyrrolidines
 - 2.1.2. Synthesis of piperidines
 - 2.2. Lanthanides and actinides
 - 2.2.1. Synthesis of pyrrolidines
 - 2.2.2. Synthesis of piperidines and azepanes
 3. Summary
- Acknowledgments
References

1. Introduction

1.1. Hydroamination

Amines represent arguably one of the most important classes of organic compounds. Many natural products (mainly alkaloids) and/or biologically active molecules contain an amino group. In industry, amines are used as solvents or starting materials for the bulk synthesis of various pharmaceuticals, antifoaming agents, corrosion inhibitors, detergents, colours and paints. The classical and established synthetic methods of amine preparation, either in the laboratory or on industrial scale, include aminations of alcohols or alkyl halides, reductive amination of carbonyl compounds, aminoalkylation and reduction of amides, nitriles, azides or nitro compounds.¹ One of the most elegant and chemically efficient synthetic approaches towards amines-hydroamination (Scheme 1) appeared with the advent of transition metals catalysis.²

[#] Part 2: Mathia, F.; Zálupský, P.; Szolcsányi, P. *Targets in Heterocyclic Systems* **2012**, *15*, 0000.

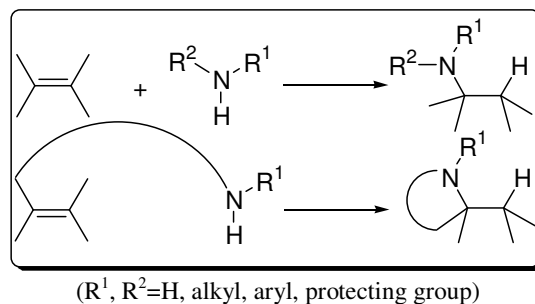

Scheme 1

A major part of the (contemporary) organometallic chemistry is primarily focused on the C–C bond formation (including C–H bond activation), while catalytic methods leading to carbon-heteroatom bond formation have been less studied. The methods for the formation of C–N bond under catalytic conditions are even rarer, thus there is a clear need for simple, yet efficient synthetic approaches leading to amines. In this context, the catalytic hydroamination of olefins and alkynes emerges as an extremely powerful methodology. Due to its obviously "atom-economical" nature, hydroamination fulfils criteria of "green chemistry"³ which is certainly not the case for metal-catalyzed aminations of organohalides⁴ (due to the unwanted salts formation). From both ecological and economical point of view, the direct addition of N–H group across the C=C bond of olefin is an ideal transformation, which delivers target amine in a single synthetic step starting from simple substrates.⁵

Until recently, the known olefin aminations often required stoichiometric amount of transition metal and truly catalytic versions of hydroaminations are still few and far between.⁴

Although the direct addition of amines to alkenes is a thermodynamically feasible process ($\Delta H^\circ \approx -52.7$ kJ·mol⁻¹ and $\Delta S^\circ \approx -127.3$ JK⁻¹·mol⁻¹ for the addition of ammonia to ethylene), hydroamination usually requires the presence of a catalyst for the following reasons:

- an electrostatic repulsion between the nitrogen lone pair of the approaching amine and the π -bond of the electron-rich olefin results in high activation barrier;
- a concerted [2+2] addition of the N–H bond to the alkene is an orbital-symmetry forbidden process and is unfavourable due to the large difference in energy between the carbon–carbon π -bond and the N–H σ -bond;
- at elevated temperatures the equilibrium is shifted towards the starting materials due to the negative reaction entropy.

For these reasons, the uncatalyzed addition of amine to the double/triple carbon-carbon bond is usually observed only in hydroaminations of activated, electron-deficient alkenes or alkynes, vinylarenes, 1,3-dienes or strained alkenes (norbornene).² On the other hand, an operationally simple and chemically efficient synthetic methodology of hydroamination of unactivated alkenes still remains one of the challenges of contemporary organometallic catalysis.⁶ Generally, the hydroamination of alkenylamines proceeds much slower and with substantial difficulties in comparison with analogous transformation of alkynylamines.⁴ Since hydroamination is a thermodynamically feasible process,² it is desirable to lower the activation barrier in order to increase the rate of cyclization of less reactive alkenylamines. One of the efficient techniques serving this purpose is the utilization of so-called Thorpe-Ingold or *gem*-dialkyl effect.⁷ In both cases, the beneficial conformational changes of the substrate are achieved by suitable substitution (with alkyl/aryl groups) of a carbon chain resulting in close spatial proximity of reacting functional groups (Scheme 2).

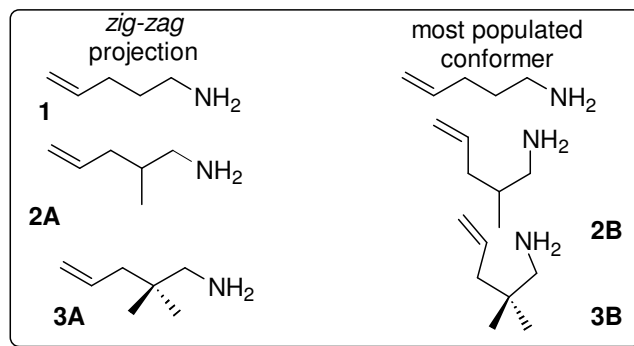

Scheme 2

The higher population of the "more reactive" conformer results in a substantial rate increase in hydroamination of activated substrate in comparison with the structurally unmodified starting compound. However, with such an activation one pays the price in terms of synthetic scope and utility. In other words, it is rather difficult to find a useful application of *gem*-disubstituted alkenylamines (however successfully hydroaminated) in the total synthesis of natural products or other structurally strictly defined targets. Moreover, the necessary initial introduction as well as the final elimination of activating *gem*-dialkyl/aryl substituent add more steps to the devised strategy. Obviously, this lengthens the synthetic route and thus partially eliminates the major synthetic advantage of cyclizative hydroamination, *i.e.* the direct preparation of saturated nitrogen heterocycles from structurally simple and easily accessible starting alkenylamines in an atom-economical fashion. Although the activating Thorpe-Ingold and/or *gem*-dialkyl effect is extremely beneficial for the hydroamination, its application must be carefully and thoroughly devised. While the utilization of such an activation strategy in the methodology development is useful and justified, one pays the price of limited scope of the reaction, *i.e.* in target-oriented syntheses.

2. Overview of hydroamination catalysts

2.1. Group I and IIA metals

2.1.1. Synthesis of pyrrolidines

Serendipity (combined with necessary academic curiosity, of course) was behind the discovery of efficient yet experimentally simple intramolecular hydroamination catalyzed by alkali metals. During the

3 Li Lithium 6.941	4 Be Beryllium 9.012182
11 Na Sodium 22.98976928	12 Mg Magnesium 24.3050
19 K Potassium 39.0983	20 Ca Calcium 40.078
37 Rb Rubidium 85.4678	38 Sr Strontium 87.62
55 Cs Caesium 132.9054519	56 Ba Barium 137.327
87 Fr Francium (223)	88 Ra Radium (226)

attempts to dehydrate the alkenylamine **3** by Na–K amalgam, Ates and Quinet⁸ noticed partial degradation of the compound. More interestingly, careful analysis of the product mixture revealed the formation of pyrrolidine **6** in 10% yield as a result of unexpected hydroamination, along with other side products resulting from isomerization of the terminal double bond. The subsequent reaction screening with sub-stoichiometric amount of *n*-BuLi in anhydrous THF yielded higher conversion of **3** and better yield of **6**. However, the undesired formation of isomerized alkene as a side product still remained (Tables 1-A and 1-B). Such a transformation was later applied to various primary and secondary alkenylamines.⁹ The optimization of hydroamination conditions eventually led to the development of useful synthetic methodology, that allowed catalytic preparation of the desired pyrrolidine **6** with high chemoselectivity. In addition, the optimized experimental procedure was subsequently applied by Markó⁵ in the racemic synthesis of natural alkaloid (±)-dihydropinidine **5** (Scheme 3).

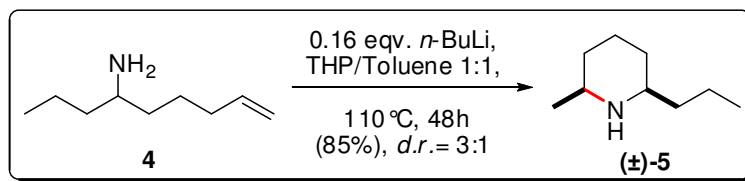

Scheme 3

Based on results in Table 1-A and Table 1-B, in the alkali metal-catalyzed intramolecular hydroamination of alkenylamines, some obvious trends could be observed:

- solvent has a strong effect on both conversion and chemoselectivity of hydroamination vs. terminal double bond isomerization (compare entries 1 vs. 3, 10 vs. 11, 12 vs. 13, 45 vs. 46 and 47 vs. 48) in a following way: solventless reactions favour the isomerized product; THF enhances the yield of hydroamination; THP/toluene mixture suppresses the undesired alkene isomerization. The latter is also the solvent of choice for domino-hydroamination reactions (entries 36 vs. 37);
- introduction of activating *gem*-dimethyl, diphenyl or cyclohexyl group raises the yield of hydroamination and also enhances the chemoselectivity of the transformation due to the suppression of alkene isomerization (entries 12, 10, 3 and 19 resp. 14–18 vs. 29–33 and 20–22, 42, 44 and 46);
- higher reaction temperature raises the yield of hydroamination and shortens the reaction time (entries 24 and 25);
- *N*-benzyl-alkenylamines provide higher yields of hydroamination than do *N*-ethylated substrates (entries 41 and 42, 43 and 44). Cyclization of the former starting compounds are also significantly faster than those of unprotected amines (entries 44 and 19, 42 and 3).

Alkali earth metals (Scheme 4) were also employed in catalytic intramolecular hydroaminations (Tables 1-A and 1-B). Hill was the first to apply the calcium complex (**A**) (Table 1-B) in the cyclizative hydroamination of activated alkenylamines substituted with *gem*-dimethyl or diphenyl groups.¹⁰ Subsequently, Roesky prepared Ca-derived¹¹ (**B** and **C**) and later also an Sr-analogue¹² (**D**), capable of delivering the desired hydroamination products under mild to acceptable reaction conditions (r.t.–110 °C, deuterobenzene) in high yields (entries 8, 20, 30 and 32). While all the catalysts **A** and **B** are very active, the enormous influence of Thorpe-Ingold effect on the reaction rate and substrate conversions is inevitable. An interesting feature is the reversal of diastereoselectivity of hydroamination by the change of metal: while calcium-based catalysts (**B** and **C**) deliver *cis*-2,5-dimethylpyrrolidine as the major product (entries 25 and 26) strontium complex **D** favours the formation of *trans*-diastereomer (entry 28).

However, in an attempted double domino-hydroamination of aminoalkadienes, Ca-catalyst was incapable of transforming the substrate to the corresponding bicyclic product.

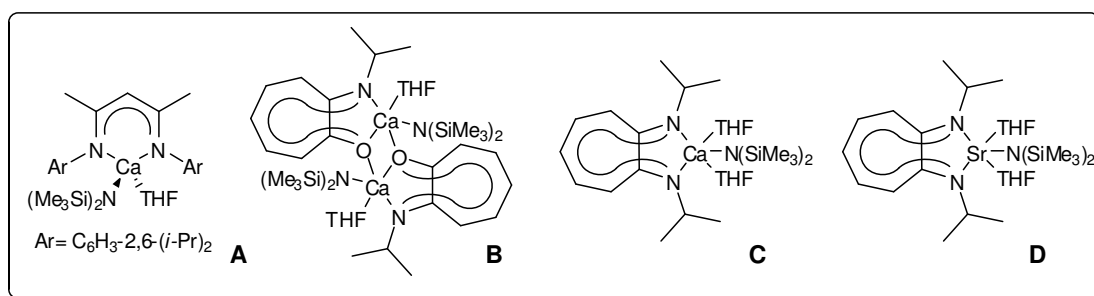

Scheme 4

Table 1-A.

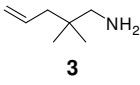
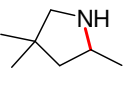
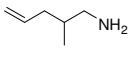
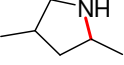
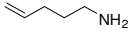
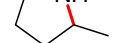
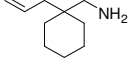
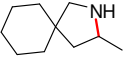
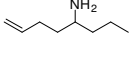
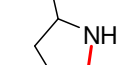
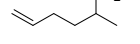
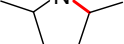
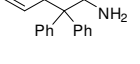
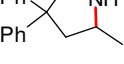
E	Catalyst/ mol %	Substrate	Product	Yield (%)	Alkene isomer ^k	Solvent	T [°C]	t [h]	Ref.			
1	Na-K			10	83%	–	r.t.	3	8			
2	<i>n</i> -BuLi/10			3	0%			19				
3	<i>n</i> -BuLi/16			95	3%			18				
4	LDA/10					85	0%	THF	–	9		
5	A/10					99 ^a			25	0.25	10	
6	B/4					80 ^a				C ₆ D ₆	r.t.	144
7	C/10					99 ^a			3			
8	C/2					95 ^a			3.5			
9	D/3					90 ^a			72			12
10	<i>n</i> -BuLi/16			60	20%	THF	50	8	8			
11				93 ^b	0%	THP/toluene	110	–	5			
12	<i>n</i> -BuLi/16			24	51%	THF	50	2	8			
13				86	0%	THP/toluene	110	–	5			
14	A/10			99	0%	C ₆ D ₆	25	21	10			
15	B/7			>80 ^a			110	10	11			
16	C/10			>90 ^a			r.t.	40				
17	C/2			>80			60	40				
18	D/10			70			r.t.	72	12			
19	<i>n</i> -BuLi/16			91	<5%	THF	r.t.	24	8			
20	B/3			99 ^a	0%	C ₆ D ₆	r.t.	8	11			
21	C/2			93 ^a				0.6				
22	D/3			90				9	12			
23	<i>n</i> -BuLi/16			73 ^c	0%	THP/toluene	110	–	5			
24	B/8			30 ^a	0%	C ₆ D ₆	r.t.	48	11			
25	B/8			>90 ^d			60	9				
26	C/8			>95 ^e			r.t.	35				
27	C/2			>90 ^e			24	12				
28	D/8			>80 ^{a,f}			28					
29	A/10			>99 ^a	0%	C ₆ D ₆	25	0.25	10			
30	B/5			99 ^a			1	11				
31	C/10			99 ^a					0.25			
32	C/2			99 ^a			1	12				
33	D/3			99 ^a			1.5					

This is probably due to unfavourable spatial repulsions in the transition state, formed by sterically demanding metal catalyst.

Table 1-B.

E	Catalyst/ mol %	Substrate	Product	Yield (%)	Alkene isomer ^k	Solvent	T [°C]	t [h]	Ref.
34	A/10			>99 ^a	0%	C ₆ D ₆	25	0.25	10
35	<i>n</i> -BuLi/16			>99 ^a	0%	dioxane	r.t.	3	9
36	<i>n</i> -BuLi/16			80	0%	THP/toluene	90	16	9
37	<i>n</i> -BuLi/16			85 ^g	0%	THP/toluene	110	–	
38	<i>n</i> -BuLi/16			84 ^g	0%	THP/toluene	110	–	
39	<i>n</i> -BuLi/16			76 ^h	0%	THP/toluene	110	–	5
40	<i>n</i> -BuLi/16			83 ^g	0%	THP/toluene	110	–	
41	<i>n</i> -BuLi/16			86	2%	THF	r.t.	5	8
42	<i>n</i> -BuLi/16			94	2%	THF	r.t.	5	
43	<i>n</i> -BuLi/16			86	2%	THF	r.t.	5	
44	<i>n</i> -BuLi/16			99	2%	THF	r.t.	5	
45	<i>n</i> -BuLi/16			79	5%	THF	r.t.	2	
46	<i>n</i> -BuLi/16			79	0%	THP/toluene	110	–	
47	<i>n</i> -BuLi/16			75 ⁱ	20%	THF	50	2	8
48	<i>n</i> -BuLi/16			79 ^j	0%	THP/toluene	110	–	5

a) Conversion determined on the basis of ¹H-NMR. b) *d.r.*=1.4:1 *cis:trans*. c) *d.r.*=2.6:1 *trans:cis*. d) *d.r.*=3:7 *cis:trans*. e) *d.r.*=1:4 *cis:trans*. f) *d.r.*=7:3 *cis:trans*. g) Single diastereomer observed. h) *d.r.*=14:1. i) *d.r.*=3.5:1 *cis:trans*. j) *d.r.*=5.7:1. k) Alkene isomerization. Yield refers to the isomerized product.

On the other hand, employment of sterically unencumbered *n*-BuLi in THP/toluene mixture (1:1) afforded the desired product after 16 hours of reflux.

The first step of the postulated mechanism⁸ of alkali metal-catalyzed hydroamination involves *N*-deprotonation of alkenylamine **A** with *n*-BuLi to form the corresponding lithium amide **B**. Subsequently,

the alkene double bond activated by coordination with Li becomes prone to the nucleophilic attack of nitrogen. Cyclization takes place forming the carbanion **C**, that is instantly hydrolyzed by the second molecule of substrate. The process releases the pyrrolidine **D** as the desired product and simultaneously (re)generates lithium amide **B**, thus closing the catalytic cycle. A concurrent side reaction, *i.e.* isomerization of terminal alkene moiety leads to the formation of undesired disubstituted C=C bond in alkenylamine **E**. Markó⁵ also postulates a slightly modified mechanism that applies to the primary alkenylamines hydroamination with stoichiometric amount of *n*-BuLi (Scheme 5).

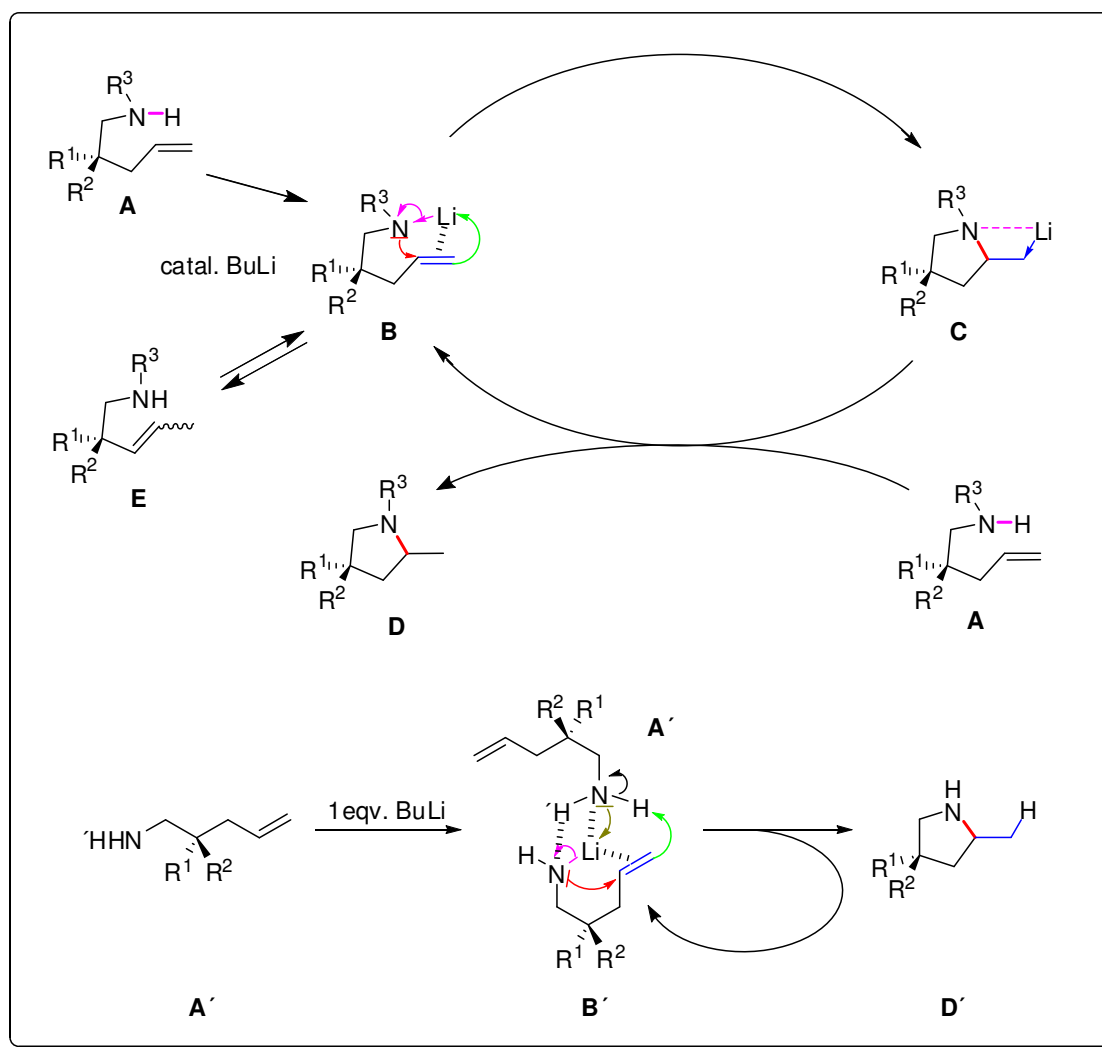

Scheme 5

Summary:

- *n*-butyllithium is simple, cheap and efficient hydroamination catalyst for the synthesis of 2-methyl-substituted pyrrolidines. It is also useful for the preparation of bicyclic compounds (starting from aminoalkadienes), as well as for hydroamination of sterically more demanding secondary alkenylamines. The only but major limitation for the employment of *n*-BuLi as hydroamination catalyst is the presence of acidic and/or electrophilic functional groups in the chain of the starting alkenylamine;
- on the other hand, catalytically active complexes of group IIA metals (Ca, Sr) are capable of tuning the diastereoselectivity of hydroamination.

2.1.2. Synthesis of piperidines

Considering the employment of group I and IIA metals in catalytic intramolecular hydroaminations, piperidines make much more scarce target molecules than pyrrolidines. Up to date, only few reported experiments deal with the preparation of saturated 6-membered azaheterocycles. Most of the published strategies make use of the Thorpe-Ingold or *gem*-dialkyl effect as the cyclization-promoting factor. However, due the relatively low number of successful precedents leading to piperidines, it is rather difficult to identify and comment on any general trend(s) regarding the hydroamination (Table 2). Nevertheless, the beneficial effect of elevated temperature on the Ca-promoted hydroamination using catalysts **A** (entries 1 vs. 2) and **C** (entries 4, 5 vs. 6) is obvious. It is also noteworthy that none of the successful hydroaminations leading to piperidines (Table 2) suffer from unwanted isomerization of terminal double bond of starting alkenylamines. On the other hand, in comparison to pyrrolidines, cyclization leading to piperidines always require higher reaction temperatures (*cf.* entry 5 in Table 1-A vs. entry 1 in Table 2, *cf.* entry 42 in Table 1-B vs. entry 10 in Table 2).

Table 2.

Entry	Catal. ^c / mol. %	Substrate	Product	Yield (%)	Solvent	T [° C]	t [h]	Ref.	
1	A/10			0	C ₆ D ₆	r.t.	24	10	
2	A/10			86 ^a		60	24		
3	B/10			>90 ^a		110	48	11	
4	C/8			>90 ^a		60	15	11	
5	C/8			70 ^a		60	6		
6	C/8			20 ^a		r.t.	47		
7	D/15					>80 ^a	60	15	12
8	<i>n</i> -BuLi/16					63 ^a	THP/toluene	110	–
9	<i>n</i> -BuLi/16			78 ^a	THP/toluene	110	–	5	
10	<i>n</i> -BuLi/16			95	THF	50	20	8	
11	<i>n</i> -BuLi/5								
12	<i>n</i> -BuLi/16								
13	<i>n</i> -BuLi/16			83	THP/toluene	110	–	5	
14	<i>n</i> -BuLi/16			85 ^b	THP/toluene	110	48	5	

a) Conversion determined on basis of ¹H-NMR. b) *d.r.*=3:1 *cis:trans*. c) Catalysts **A–D** are depicted in Scheme 4.

The reaction mechanism of Ca-catalyzed hydroamination has been postulated by Hill.¹⁰ The first step involves a transamination of catalyst **A** with substrate **B** and formation of calcium amide intermediate **C** with the concomitant release of HMDS. The next key step represents an insertion of alkene into the

calcium–nitrogen bond. The cyclized pyrrolidine **D** is subsequently hydrolyzed with the second molecule of alkenylamine **B**, furnishing the pyrrolidine **E** as the desired product and simultaneously (re)generating the catalytically active complex **C** that (re)enters the reaction cycle (Scheme 6).

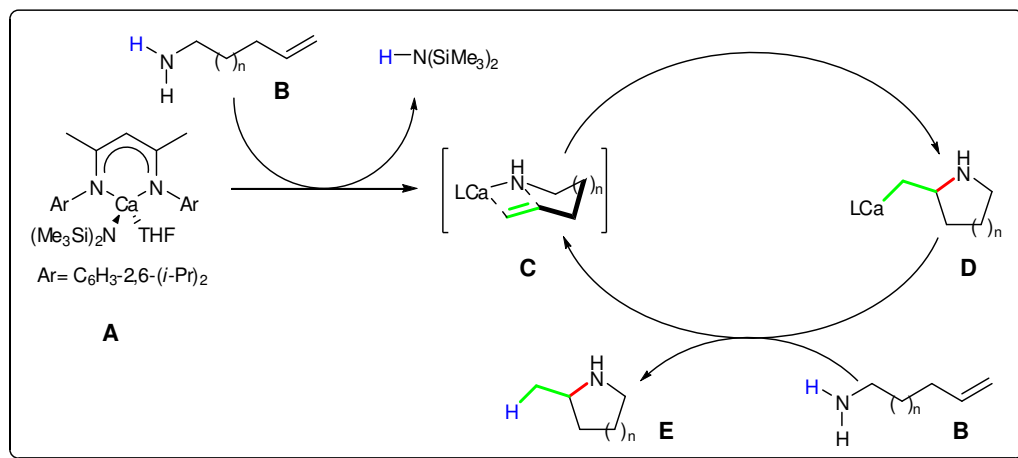

Scheme 6

2.2. Lanthanides and actinides

57 La Lanthanum 138.90547	58 Ce Cerium 140.116	59 Pr Praseodymium 140.90795	60 Nd Neodymium 144.242	61 Pm Promethium (145)	62 Sm Samarium 150.36	63 Eu Europium 151.964	64 Gd Gadolinium 157.25	65 Tb Terbium 158.92535	66 Dy Dysprosium 162.50	67 Ho Holmium 164.93032	68 Er Erbium 167.259	69 Tm Thulium 168.93421	70 Yb Ytterbium 173.054	71 Lu Lutetium 174.9668
89 Ac Actinium (227)	90 Th Thorium 232.03806	91 Pa Protactinium 231.03588	92 U Uranium 238.02891	93 Np Neptunium (237)	94 Pu Plutonium (244)	95 Am Americium (245)	96 Cm Curium (247)	97 Bk Berkelium (247)	98 Cf Californium (251)	99 Es Einsteinium (252)	100 Fm Fermium (257)	101 Md Mendelevium (258)	102 No Nobelium (259)	103 Lr Lawrencium (262)

2.2.1. Synthesis of pyrrolidines

The first intramolecular hydroamination catalyzed by rare earth metals was performed by Marks.¹³ The author presented a kinetic study of the cyclization of primary and secondary alkenylamines promoted by organolanthanide hydrides (1–5 mol. %) producing the corresponding pyrrolidines and/or piperidines (Table 3). It paved way to novel, highly effective methodology leading to saturated nitrogen heterocycles. It is more interesting that the use of Ln-type catalysts in hydroaminations was premeditated. Earlier, the bis(penta-methyl cyclopentadienyl)lanthane catalysts ($\text{Cp}'_2\text{LnH}$)₂ were used for polymerization of ethylene. Because of the ease and rate (1 atm $\text{CH}_2=\text{CH}_2$, 25 °C, $N_t \geq 1800 \text{ s}^{-1}$) with which it could insert itself into the La–X bond (X=alkyl, hydride), it was assumed that the insertion of $\text{CH}_2=\text{CH}_2$ into another metal–X bond (Eq. 1) might be not only thermodynamically feasible, but fast as well. The catalytic cycle of addition of H–X to olefin could then be completed by including into the reaction sequence a protonolysis (Eq. 2).

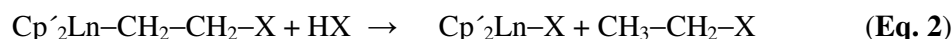
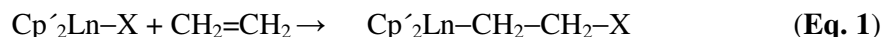

Thus, in case of Ln-amides (X=NR₂) insertion proved to be approximately thermo neutral, protonolysis was exothermic and hence potentially fast. Marks' expectations were fulfilled and allowed him to cyclize primary and secondary alkenylamines to pyrrolidines and piperidines by use of 1-5 molar per cent of catalyst in hydrocarbon solvents (Table 4). Hydroamination according to Marks is a fast reaction

($N_t=1-125 \text{ h}^{-1}/25 \text{ }^\circ\text{C}$) proceeding with high regioselectivity of addition of $-\text{NH}$ to the $\text{C}=\text{C}$ double bond ($>95\%$). These results had a strong appeal in the wider scientific community and stimulated intense research in this area. Marks made good use of his experience with lanthanide catalysis and in further work expanded its scope to derivatives of samarium and neodymium.^{14,15}

Table 3.

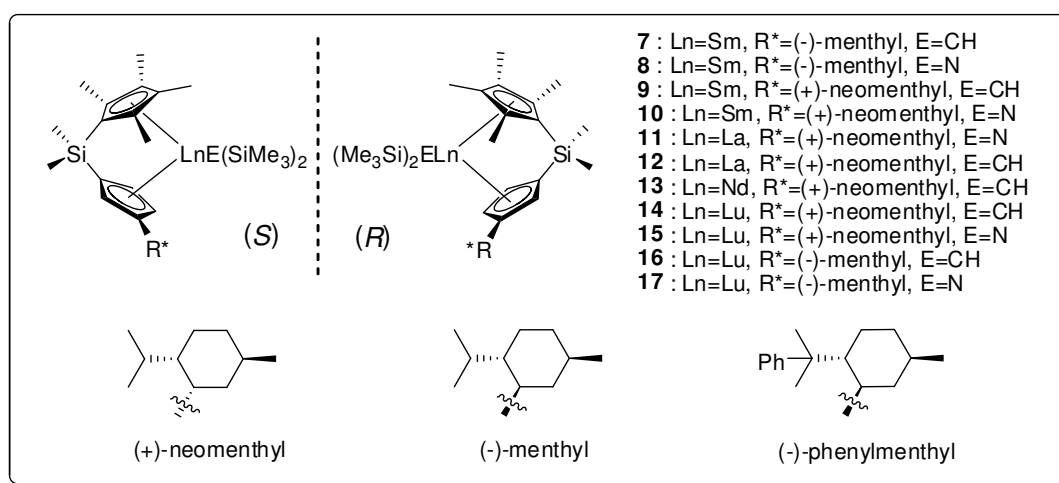

Substrate	Product	$N_t [\text{h}^{-1}]$ ($^\circ\text{C}$)	Catalyst
		13 (25) 140 (60)	$(\text{Cp}^* \text{LaH})_2$ $[\text{Me}_2\text{Si}(\text{Me}_4\text{C}_5)_2\text{LuH}]_2$
		125 (25) 75 (80) <1 (80)	$(\text{Cp}^* \text{LaH})_2$ $[\text{Me}_2\text{Si}(\text{Me}_4\text{C}_5)_2\text{LuH}]_2$ $(\text{Cp}^* \text{LuH})_2$
		84 (25)	$(\text{Cp}^* \text{LaH})_2$
		5 (60)	$(\text{Cp}^* \text{LaH})_2$
		13 (80)	$(\text{Cp}^* \text{LaH})_2$







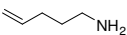



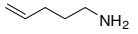

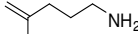

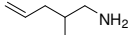
Scheme 7

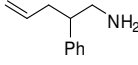
Moreover, by introducing a chiral auxiliary^{16,17} to one of the ligands, he was able to achieve relatively high enantiomeric excesses in the mixture of products of hydroamination of aminoalkenes (*ee* up to 74%). Marks used menthyl, neomenthyl and phenylmenthyl as sources of chirality (Scheme 7, Table 4).

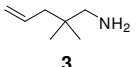
Table 4.

E	Catalyst/mol%	Substrate	Product	Y (%)	Solvent	N _t [h ⁻¹]	T [°C]	t [h]	Comment	Ref.	
1	(Cp ⁺ ₂ LaH) ₂ / _{<5}			>95 ^a	HCS	13	25			13	
2				140		60					
3	Cp ⁺ ₂ Sm(THF) ₂ / _{<5}			>95 ^a	HCS	5	60			14	
4	Cp ⁺ ₂ Sm(THF) ₂ / _{<1}			85	pentane		60	48		14	
5	Cp ⁺ ₂ LaCH(TMS) ₂ / _{2.8}			>95 ^a	toluene- <i>d</i> ₈	140	60			15	
6	Cp ⁺ ₂ LaCH(TMS) ₂ / _{0.4}			86	pentane		r.t.	24			
7	<i>(S)</i> - 7 -Sm/ <i>(S)</i> - 8 -Sm/ _{<1} ^c			100 ^d	pentane	33	25			<i>ee</i> =62 (+)	16
8							0			<i>ee</i> =72 (+)	
9	<i>(R)</i> - 9 -Sm/ <i>(R)</i> - 10 -Sm/ _{<1} ^c					62	25			<i>ee</i> =52 (-)	
10							0			<i>ee</i> =58 (-)	
11								25			
12	<i>(R,S)</i> - 12 -La/ _{<1} ^c			100 ^d	pentane		25	<12		<i>ee</i> =36 (-)	17
13	<i>(R,S)</i> - 13 -Nd/ _{<2.5} ^c					93	25			<i>ee</i> =55 (-)	
14						11	0			<i>ee</i> =64 (-)	
15	<i>(R,S)</i> - 9 -Sm/ _{<2.5} ^c					42	25			<i>ee</i> =61 (-)	
16	<i>(S)</i> - 10 -Sm/ _{<2.5}					33				<i>ee</i> =55 (-)	
17	<i>(R)</i> - 8 -Sm/ _{<1}							<12		<i>ee</i> =60 (+)	
18	<i>(R,S)</i> - 14 -Lu/ _{<1} ^c							24–72		<i>ee</i> =29 (+)	
19	(OHF)- 8 ^l -Sm/ _{<3}					100 ^a	C ₆ D ₆	2.6	25		
20				28.4	60					<i>ee</i> =37 (+)	
21					60					<i>ee</i> =16 (-)	
22	<i>(R,R)</i> - 23 -La/ ₂			>99 ^a	C ₆ D ₆	5	60	19		<i>ee</i> =2	44
23	<i>(R)</i> - 24 -La/ ₂			98 ^a		5.3	60	25		<i>ee</i> =0	

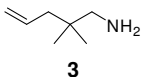



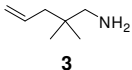
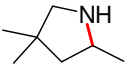

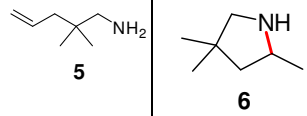

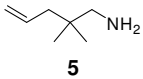
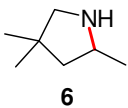
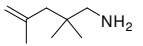
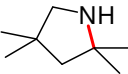
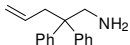
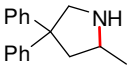
E	Catalyst/mol%	Substrate	Product	Y (%)	Solvent	N _t [h ⁻¹]	T [°C]	t [h]	Comment	Ref.	
24	(<i>R</i>)- 25 -Lu/2			96 ^a	C ₆ D ₆	18	60	4	<i>ee</i> =72	42	
25	(<i>R</i>)- 26 -Lu/5			93 ^a		1.7	22	16.5	<i>ee</i> =90 (<i>S</i>)		
26	(<i>R</i>)- 26 -Lu/4			92 ^a	toluene- <i>d</i> ₈	0.13	0	190	<i>ee</i> =92 (<i>S</i>)		
27	1.2x L9 +La[N(TMS) ₂] ₃ /5			>98 ^a	C ₆ D ₆	0.09	23		<i>ee</i> =40 (<i>R</i>)	37	
28	[(TMS-Cp) ₂ NdMe] ₂ /3.9			95	–		120	12		22	
29	Cp [∗] ₂ LaCH(TMS) ₂ /2.8			>95 ^a	toluene- <i>d</i> ₈	36	25			15	
30	Nd[N(TMS) ₂] ₃ / _{2.7}			>95 ^a	C ₆ D ₆		90	7d	<i>cis:trans</i> =1:2	28	
31	Sm[N(TMS) ₂] ₂ /10			87	THF		60	100		29	
32	Nd[N(TMS) ₂] ₃ / _{2.7}			95 ^a	C ₆ D ₆		90	1.5	<i>cis:trans</i> =1:2.2	28	
33	(Cp [∗] ₂ LaH) ₂ / ₅			>95 ^a	HCS	125	25			13	
34	[Me ₂ Si(Me ₄ C ₅) ₂ LuH] ₂ / ₅					75	80				
35	(Cp [∗] ₂ LuH) ₂ / ₅					<1	80				
36	(Cp [∗] ₂ LaH) ₂ / ₅				THF- <i>d</i> ₈	17	25				
37	Cp [∗] ₂ Sm(THF) ₂ / ₅				HCS	50	60				14
38	Cp [∗] ₂ LaCH(TMS) ₂ /2.8				95	25					15
39	Cp [∗] ₂ SmCH(TMS) ₂ / ₁₄				48	60					
40	Cp [∗] ₂ LuCH(TMS) ₂ / ₁₄				<1						
41	Me ₂ Si(Me ₄ C ₅) ₂ LuCH(TMS) ₂ / ₁₄				75	80					
42	Me ₂ Si(Me ₄ C ₅)Cp [∗] LuCH(TMS) ₂ /14				200						
43	(<i>S</i>)- 7 -Sm/(<i>S</i>)- 8 -Sm/<1 ^c			100 ^d	pentane	84	25		<i>ee</i> =53 (+)	16	
44							–30		<i>ee</i> =74 (+)		

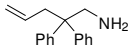

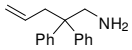

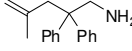
E	Catalyst/mol%	Substrate	Product	Y (%)	Solvent	N _t [h ⁻¹]	T [°C]	t [h]	Comment	Ref.
45	(R)- 9 -Sm/(R)- 10 -Sm/<1 ^c			100 ^d	pentane		25		ee=51 (-)	16
46							-30		ee=64 (-)	
47							25		ee=14 (-)	
48	(R,S)- 13 -Nd/<2.5 ^e			100 ^d	pentane		-20	<12	ee=61 (-)	17
49	(R,S)- 14 -Lu/<1 ^c						25	24-72	ee=36 (+)	
50	(R)- 15 -Lu/<1							ee=40 (+)		
51	(R)- 16 -Lu/<1								ee=29 (-)	
52	(EBI)YbN(SiMe ₃) ₂ /3			79 ^f	toluene		r.t.	70		23
53	[Me ₂ Si(C ₅ Me ₄)(<i>t</i> -BuN)]SmN(TMS) ₂ / ₂				toluene- <i>d</i> ₈		25	181		24
54	[Me ₂ Si(C ₅ Me ₄)(<i>t</i> -BuN)]NdN(TMS) ₂ / ₂							200		
55	[Me ₂ Si(C ₅ Me ₄)(<i>t</i> -BuN)]YbCH(TMS) ₂ / ₂							10		
56	[Me ₂ Si(C ₅ Me ₄)(<i>t</i> -BuN)]LuCH(TMS) ₂ / ₂							90		
57	Nd[N(TMS) ₂] ₃ / _{2.7}			>95 ^a	C ₆ D ₆		24	4		28
58	L1 +Sm[N(SiMe ₂ H) ₂] ₃ (THF) ₂ /3			>95 ^a	toluene- <i>d</i> ₈		60	7d	ee=50	32
59	L1 +La[N(SiMe ₂ H) ₂] ₃ (THF) ₂ /3								ee=33	
60	(OHF)- 8 ⁱ -Sm/<3			100 ^a	C ₆ D ₆		25		ee=32 (+)	27
61	(OHF)- 17 ⁱ -Lu/<3								ee=1.5 (+)	
62	20 -Lu/4.4		C ₆ D ₆		25			26		
63	21 -Yb/<5	0	C ₆ D ₆		120	120		38		
64	L2 +La[N(SiMe ₂ H) ₂] ₃ (THF) ₂ / ₄	>95 ^a	toluene- <i>d</i> ₈		60	5d	ee=34	33		
65	L3 +Sm[N(SiMe ₂ H) ₂] ₃ (THF) ₂ /1	100 ^a	C ₆ D ₆		70		44	ee=0	33	
66	L3 +La[N(SiMe ₂ H) ₂] ₃ (THF) ₂ /1						40	ee=0		
67	L4 +Sm[N(SiMe ₂ H) ₂] ₃ (THF) ₂ /1						30	ee=27		

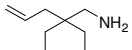
E	Catalyst/mol%	Substrate	Product	Y (%)	Solvent	N _t [h ⁻¹]	T [°C]	t [h]	Comment	Ref.				
68	L4 +La[N(SiMe ₂ H) ₂] ₃ (THF) ₂ /1			100 ^a	C ₆ D ₆		70	40	<i>ee</i> =61	33				
69	[Me ₂ Si(C ₅ Me ₄)(<i>t</i> -BuN)]Th(NR ₂) ₂ / $<7^j$			>90 ^a	C ₆ D ₆	15	25				25			
70	[Me ₂ Si(C ₅ Me ₄)(<i>t</i> -BuN)]U(NR ₂) ₂ / $<7^j$					2.5								
71	Cp' ₂ ThMe ₂ / <5					0.4								
72	(<i>R,S</i>)- 22 -La/4			82	C ₆ D ₆	4	70				43			
73	(<i>R,R</i>)- 23 -La/2			95 ^a	C ₆ D ₆	35	25	1.5		<i>ee</i> =8	44			
74	(<i>R</i>)- 24 -La/2			98 ^a		61		1	<i>ee</i> =8					
75	(<i>R</i>)- 25 -Lu/2			94 ^a	C ₆ D ₆	2.4	22	27.5		<i>ee</i> =69 (<i>S</i>)	42			
76	(<i>R</i>)- 26 -Lu/3			95 ^a		3.1		14	<i>ee</i> =68 (<i>S</i>)					
77	2.3x L9 +Sm[N(TMS) ₂] ₃ /5			>98 ^a	C ₆ D ₆		60			<i>ee</i> =60 (<i>R</i>)	37			
78	1.2x L9 +Nd[N(TMS) ₂] ₃ /5					10		23		<i>ee</i> =61 (<i>R</i>)				
79	2.3x L9 +La[N(TMS) ₂] ₃ /5					10				<i>ee</i> =63 (<i>R</i>)				
80	1.2x L5 +La[N(TMS) ₂] ₃ /5					3.2				<i>ee</i> =6 (<i>R</i>)				
81	1.2x L6 +La[N(TMS) ₂] ₃ /5					1.3				<i>ee</i> =39 (<i>R</i>)				
82	1.2x L7 +La[N(TMS) ₂] ₃ /5					7.1				<i>ee</i> =56 (<i>S</i>)				
83	1.2x L8 +La[N(TMS) ₂] ₃ /5					1.8				<i>ee</i> =25 (<i>R</i>)				
84	1.2x L9 +La[N(TMS) ₂] ₃ /5					25				<i>ee</i> =67 (<i>R</i>)				
85	1.2x L10 +La[N(TMS) ₂] ₃ /5					21				<i>ee</i> =61 (<i>S</i>)				
86	1.2x L11 +La[N(TMS) ₂] ₃ /5					17				<i>ee</i> =55 (<i>S</i>)				
87	1.2x L12 +La[N(TMS) ₂] ₃ /5					17				<i>ee</i> =59 (<i>S</i>)				
88	(R)- 33 -Yb/10	49 ^a	C ₆ D ₆						25	7d			<i>ee</i> =69	35
89		98 ^a							60	46			<i>ee</i> =42	
90		(R)- 34 -Yb/10		77 ^a		25	7d			<i>ee</i> =73				

E	Catalyst/mol%	Substrate	Product	Y (%)	Solvent	N _t [h ⁻¹]	T [°C]	t [h]	Comment	Ref.	
91	(<i>R</i>)- 35 -Lu/10			91 ^a	C ₆ D ₆		25	5d	<i>ee</i> =66	35	
92	1.1x L13 +La[N(TMS) ₂] ₃ /5						0.38	60		<i>ee</i> =26 (<i>S</i>)	41
93	1.1x L13 +Nd[N(TMS) ₂] ₃ /5					0.69			<i>ee</i> =27 (<i>S</i>)		
94	1.1x L13 +Sm[N(TMS) ₂] ₃ /5					0.26			<i>ee</i> =40 (<i>S</i>)		
95	1.1x L13 +Lu[N(TMS) ₂] ₃ /5					0.16			<i>ee</i> =61 (<i>S</i>)		
96	1.1x L14 +La[N(TMS) ₂] ₃ /5					2			<i>ee</i> =61 (<i>S</i>)		
97	1.1x L14 +Nd[N(TMS) ₂] ₃ /5					0.053	23		<i>ee</i> =65 (<i>S</i>)		
98	1.1x L14 +Sm[N(TMS) ₂] ₃ /5					0.043	23		<i>ee</i> =63 (<i>S</i>)		
99	1.1x L14 +Lu[N(TMS) ₂] ₃ /5					0.067	60		<i>ee</i> =7.5 (<i>S</i>)		
100	1.1x L15 +La[N(TMS) ₂] ₃ /5					0.31	23		<i>ee</i> =23 (<i>S</i>)		
101	1.1x L15 +Nd[N(TMS) ₂] ₃ /5					3	23		<i>ee</i> =37 (<i>S</i>)		
102	1.1x L15 +Sm[N(TMS) ₂] ₃ /5					4.2	23	<i>ee</i> =36 (<i>S</i>)			
103	1.1x L15 +Lu[N(TMS) ₂] ₃ /5					1.2	23	<i>ee</i> =37 (<i>S</i>)			
104	1.1x L16 +La[N(TMS) ₂] ₃ /5					0.96	60	<i>isomerisation</i>			
105	1.1x L16 +Nd[N(TMS) ₂] ₃ /5					3.1	60	<i>ee</i> =23 (<i>S</i>)			
106	1.1x L16 +Sm[N(TMS) ₂] ₃ /5					3.9	60	<i>ee</i> =25 (<i>S</i>)			
107	1.1x L16 +Lu[N(TMS) ₂] ₃ /5					0.49	60	<i>ee</i> =26 (<i>S</i>)			
108	1.1x L17 +La[N(TMS) ₂] ₃ /5					0.16	23	<i>ee</i> =40 (<i>S</i>)			
109	1.1x L17 +Nd[N(TMS) ₂] ₃ /5					0.23	23	<i>ee</i> =32 (<i>S</i>)			
110	1.1x L17 +Sm[N(TMS) ₂] ₃ /5					0.14	23	<i>ee</i> =13 (<i>S</i>)			
111	1.1x L17 +Lu[N(TMS) ₂] ₃ /5			0.072	60	<i>ee</i> =27 (<i>S</i>)					
112	1.1x L18 +Sm[N(TMS) ₂] ₃ /5			0.26	60	<i>ee</i> =0.8 (<i>S</i>)					
113	(<i>R</i> ¹ , <i>S</i> , <i>S</i>)- 37 -Yb/6			97 ^a	C ₆ D ₆		25	24	<i>ee</i> =32	30	

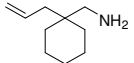
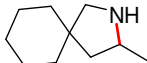
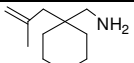
E	Catalyst/mol%	Substrate	Product	Y (%)	Solvent	N _t [h ⁻¹]	T [°C]	t [h]	Comment	Ref.
114	(R',R,R)-37-Yb/6			100 ^a	C ₆ D ₆		25	8.5	ee=17	30
115	(R',S,R)-37-Yb/6			99 ^a				27	ee=22	
116	(R)-36-Yb/6			>90 ^a				45	ee=28	
117	(R)-32-Yb/6			94 ^a				96	ee=22	
118	(R)-38-Yb/6			94 ^a	C ₆ D ₆	60	17	ee=69	36	
119	Sm[N(TMS) ₂] ₂ /10			87	THF		60	24		29
120	[(TMS-Cp) ₂ SmMe] ₂ /5.6			93	-		70	2		22
121	[(TMS-Cp) ₂ NdMe] ₂ /5.6			70	C ₆ D ₆		70	1		
122	Nd[N(TMS) ₂] ₂ /3			94 ^a	C ₆ D ₆		70	8		
123	20-Lu/4.4				C ₆ D ₆	205	25			26
124	[Me ₂ Si(C ₅ Me ₄)(<i>t</i> -BuN)]Th(NR ₂) ₂ / $<7^l$			>90 ^a	C ₆ D ₆	1460	25			25
125	[Me ₂ Si(C ₅ Me ₄)(<i>t</i> -BuN)]U(NR ₂) ₂ / $<7^l$	430								
126	(R)-25-Lu/3			96 ^a	C ₆ D ₆	>180	25	0.25	ee=93 (<i>S</i>)	41
127	(R)-26-Lu/3					>500		0.1	ee=80 (<i>S</i>)	
128	1.2xL9+La[N(TMS) ₂] ₃ /1.3			>98 ^a	C ₆ D ₆	660	23		ee=34 (<i>R</i>)	37
129	(R)-33-Yb/10			100 ^a	C ₆ D ₆		25	24	ee=50	35
130	(R)-34-Yb/3			100 ^a				21	ee=62	
131	(R)-35-Lu/2			100 ^a				21	ee=60	
132	(R',S,S)-37-Yb/6			100 ^a					1.5	
133	(R',R,R)-37-Yb/6						1.5	ee=50		
134	(R',S,R)-37-Yb/6						3	ee=58		
135	(R)-36-Yb/6						1.5	ee=52		
136	(R)-32-Yb/6						0.5	ee= -23 ^k		

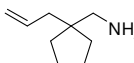
E	Catalyst/mol%	Substrate	Product	Y (%)	Solvent	N _t [h ⁻¹]	T [°C]	t [h]	Comment	Ref.		
137	(<i>R</i>)- 38 -Yb/6			100 ^a	toluene- <i>d</i> ₈		0	168	<i>ee</i> =78	36		
138	39 -Sm/2			75 ^a	C ₆ D ₆	0.19	120			39		
139	[(TMS-Cp) ₂ SmMe] ₂ /4			98	C ₆ D ₆		r.t.	1		22		
140	21 -Yb/5.1			92 ^a	C ₆ D ₆	0.19	120	96		38		
141	(<i>R</i>)- 25 -Lu/2			95 ^a	C ₆ D ₆	460	25	0.11	<i>ee</i> =83 (<i>S</i>)	42		
142	(<i>R</i>)- 26 -Lu/2			100		0.5		<i>ee</i> =78 (<i>S</i>)				
143	(<i>R</i>)- 27 -Yb/3.5			87 ^a	C ₆ D ₆		r.t.	1.5	<i>ee</i> =41	31		
144	(<i>R</i>)- 28 -Sm/5			78 ^a		2		<i>ee</i> =24				
145	(<i>R</i>)- 29 -Nd/7			84 ^a		3		<i>ee</i> =1				
146	(<i>R</i>)- 30 -Lu/17			91 ^a		3		<i>ee</i> =16				
147	(<i>R</i>)- 31 -Yb/3			98 ^a		1.5		<i>ee</i> =9				
148	(<i>R</i>)- 32 -Yb/7			100 ^a		0.5		<i>ee</i> =12				
149	(<i>R</i>)- 33 -Yb/5			67 ^a		48		<i>ee</i> =70				
150	(<i>R</i>)- 33 -Yb/5			100 ^a		C ₆ D ₆		25	6d		<i>ee</i> =66	35
151	(<i>R</i>)- 34 -Yb/10			88 ^a		C ₆ D ₆		0	4d		<i>ee</i> =76	35
152	(<i>R</i>)- 35 -Lu/10			75 ^a				0	88		<i>ee</i> =68	
153	(<i>R'</i> , <i>S</i> , <i>S</i>)- 37 -Yb/6			93 ^a	C ₆ D ₆		25	3.5	<i>ee</i> =21	30		
154	(<i>R'</i> , <i>R</i> , <i>R</i>)- 37 -Yb/6			100 ^a		4.5		<i>ee</i> =16				
155	(<i>R'</i> , <i>S</i> , <i>R</i>)- 37 -Yb/6			69 ^d		3		<i>ee</i> =28				
156	(<i>R</i>)- 36 -Yb/6			96 ^a		21		<i>ee</i> =28				
157	(<i>R</i>)- 32 -Yb/6			92 ^a		23		<i>ee</i> =38				
158	(<i>R</i>)- 38 -Yb/6	90 ^a	C ₆ D ₆	25		20		<i>ee</i> =85	36			

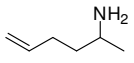
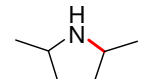
E	Catalyst / mol%	Substrate	Product	Y (%)	Solvent	N _t [h ⁻¹]	T [°C]	t [h]	Comment	Ref.
159	39-Sm/2			44 ^a	C ₆ D ₆	0.13	120			39
160	40-Er/2			56 ^a				0.20		
161	Sm[N(TMS) ₂] ₂ /10			93	THF		60	24		29
162	[(TMS-Cp) ₂ SmMe] ₂ /3.8			92	C ₆ D ₆		r.t.	1		22
163	(R)-34-Yb/10			83 ^a	C ₆ D ₆		25	4d	<i>ee</i> =69	35
164				74 ^a			0	16d	<i>ee</i> =77	
165	(R)-35-Lu/10			80 ^a			25	2d	<i>ee</i> =68	
166	(R)-38-Yb/4			100 ^a	C ₆ D ₆		60	15	<i>ee</i> =73	36
167	(Cp [*] ₂ LaH) ₂ / _{<} 5			>95 ^a	HCS	84	25			13
168	Cp [*] ₂ Sm(THF) ₂ / _{<} 5					40	60		14	
169	Cp [*] ₂ LaCH(TMS) ₂ /2.8				toluene- <i>d</i> ₈	45	25			
170	Cp [*] ₂ LaCH(TMS) ₂ / _{<} 14			>95 ^a	toluene- <i>d</i> ₈		0		<i>cis:trans</i> =1:8	15
171							50		<i>cis:trans</i> =1:1.5	
172	Cp [*] ₂ LaCH(TMS) ₂ /6			>98 ^a		25	17	<i>cis:trans</i> =1:50 ^b		
173	Cp [*] ₂ LaCH(TMS) ₂ / _{<} 14			>95 ^a	THF- <i>d</i> ₈		25		<i>cis:trans</i> =1:2	
174	Cp [*] ₂ NdCH(TMS) ₂ / _{<} 14				toluene- <i>d</i> ₈			25		<i>cis:trans</i> =1.25:1
175	Me ₂ Si(Me ₄ C ₅) ₂ NdCH(TMS) ₂ / _{<} 14								<i>cis:trans</i> =1:20	
176	Cp [*] ₂ NdCH(TMS) ₂ / _{<} 14								<i>cis:trans</i> =1:4 ^b	
177	Cp [*] ₂ SmCH(TMS) ₂ / _{<} 14								<i>cis:trans</i> =1.25:1	
178	Me ₂ Si(Me ₄ C ₅) ₂ SmCH(TMS) ₂ / _{<} 14								<i>cis:trans</i> =1:1	
179	Me ₂ Si(Me ₄ C ₅)Cp [*] LuCH(TMS) ₂ / _{<} 14								<i>cis:trans</i> =1:4	
180	(EBI)YbN(TMS) ₂ /2				86 ^l	toluene		70	48	<i>cis:trans</i> =10:1

E	Catalyst/mol%	Substrate	Product	Y (%)	Solvent	N _t [h ⁻¹]	T [°C]	t [h]	Comment	Ref.
181	[Me ₂ Si(C ₅ Me ₄)(<i>t</i> -BuN)]SmN(TMS) ₂ / <2.5				toluene- <i>d</i> ₈	24	25		<i>cis:trans</i> =1:10	24
182	[Me ₂ Si(C ₅ Me ₄)(<i>t</i> -BuN)]NdN(TMS) ₂ / <2.5			24		<i>cis:trans</i> =1:10				
183	[Me ₂ Si(C ₅ Me ₄)(<i>t</i> -BuN)]YbCH(TMS) ₂ / <2.5			34		<i>cis:trans</i> =1:21				
184	[Me ₂ Si(C ₅ Me ₄)(<i>t</i> -BuN)]LuCH(TMS) ₂ / <2.5			28		<i>cis:trans</i> =1:17				
185	Cp [*] ₂ SmN(TMS) ₂ / <2.5			9.1						
186	Cp [*] ₂ LuCH(TMS) ₂ / <2.5			0.5						
187	Nd[N(TMS) ₂] ₃ / <2.7			94 ^a	C ₆ D ₆		90	2d	<i>cis:trans</i> =1:4	28
188	18 -Nd/5			$>95^a$	C ₆ D ₆		60	0.75	<i>cis:trans</i> =1:6	40
189	19 -Dy/5			41 ^b	C ₆ D ₆			0.25	<i>cis:trans</i> =1:10	40
190	(<i>R,R</i>)- 23 -La/2			93 ^a	C ₆ D ₆	1.7	25	49	<i>cis:trans</i> =1:9	44
191	(<i>R</i>)- 24 -La/2			95 ^a		23	60	5	<i>cis:trans</i> =1:5.3	
192	39 -Sm/2			0	C ₆ D ₆		120			39
193	Sm[N(TMS) ₂] ₃ /10			95	THF		60	24	<i>cis:trans</i> =1:2.6	29
194	Sm[N(TMS) ₂] ₃ /10			73	toluene		100	24	<i>cis:trans</i> =1:3.2	
195	[(TMS-Cp) ₂ NdMe] ₂ /4.8			90	–		140	14d		22
196				80	C ₆ D ₆		120	12d		
197	[(TMS-Cp) ₂ NdMe] ₂ /5.5			85	C ₆ D ₆		120	20		22
198	[(TMS-Cp) ₂ SmMe] ₂ /6.3			77				120	48	

E	Catalyst/mol%	Substrate	Product	Y (%)	Solvent	N _t [h ⁻¹]	T [°C]	t [h]	Comment	Ref.
199	[(TMS-Cp) ₂ NdMe] ₂ /41			53	C ₆ D ₆		120	7d		22
200	[(TMS-Cp) ₂ NdMe] ₂ /5.7			99				4		
201	Cp' ₂ SmCH(TMS) ₂ /2.1			93	C ₆ D ₆	55	21		<i>cis:trans</i> =9:11	15
202	Me ₂ Si(Me ₄ C ₅) ₂ NdCH(TMS) ₂ /2.1			1		60				
203	(EBI)YbN(SiMe ₃) ₂ /2			86 ^f	toluene		r.t.	22		23
204	(<i>R,R</i>)- 23 -La/2			>99 ^a	C ₆ D ₆	>120	29	0.4		44
205	(<i>R</i>)- 24 -La/2					>330	25	0.15		
206	(<i>R</i>)- 25 -Lu/2			94 ^a	C ₆ D ₆	80	22	0.8	42	
207	(<i>R</i>)- 26 -Lu/1			95 ^a		67		1.6		
208	Sm[N(TMS) ₂] ₂ /10					93	THF		60	6
209	Cp' ₂ Sm(THF) ₂ / _{<5}			>95 ^a	HCS	0.5	60		14	
210	Me ₂ Si(Me ₄ C ₅) ₂ NdCH(TMS) ₂ /2.8			>95 ^a	toluene- <i>d</i> ₈	11	25		15	
211	(EBI)YbN(SiMe ₃) ₂ /2			0	toluene		80	96	23	
212	Cp' ₂ SmCH(TMS) ₂ /10			91 ^g	C ₆ D ₆		50		<i>d.r.</i> =25:1	45
213	Cp' ₂ SmCH(TMS) ₂ /10			84 ^g	C ₆ D ₆		r.t.		<i>d.r.</i> =1:1	45

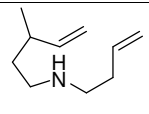
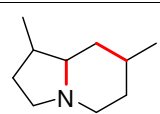
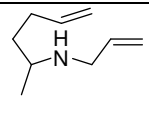
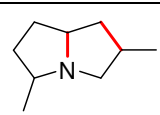
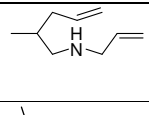
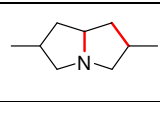
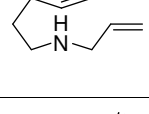
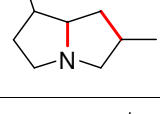
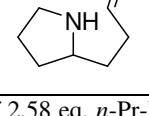
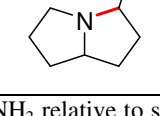
E	Catalyst/mol%	Substrate	Product	Y (%)	Solvent	N _t [h ⁻¹]	T [°C]	t [h]	Comment	Ref.
214	Cp'₂SmCH(TMS)₂/10			91 ^g	C₆D₆		r.t.		<i>d.r.</i> =6:1	45
215	Cp'₂SmCH(TMS)₂/10			83	C₆D₆		50		<i>d.r.</i> =2:1	45
216	Cp'₂SmCH(TMS)₂/10			83	C₆D₆		r.t.		<i>d.r.</i> =1.3:1	45
217	Cp'₂SmCH(TMS)₂/10			88	C₆D₆		r.t.		<i>d.r.</i> =1.5:1	45
218	Sm[N(TMS)₂]₃/10			86	THF		60	24		29
219				100 ^a	toluene		100	24		
220				6 ^a	THF		60	48		

a) Conversion determined by NMR. b) Addition of 2.58 eq. *n*-Pr-NH₂ relative to substrate. c) Ln-amide and Ln-alkyl catalysts gave "almost identical" results. d) Conversion determined by LC. e) Epimerization of catalyst under conditions of hydroamination occurred. f) Product isolated as *N*-Ac derivative. g) Product isolated as hydrochloride. h) Reaction stopped after 15 min., no further monitoring. i) Cp' residue without chiral substituent replaced by octahydrofluorenyl. j) Character of leaving amine (R=Me₂, Et₂, Me+Et) had no influence on N_t. k) Product mixture was dominated by the enantiomer opposite to the product arisen by the action of (*R*)-**36**-Yb.

High reactivity of the lanthanocene catalysts has been connected with accessibility of the metal centre of the catalysts both to amine nitrogen and to the terminal double bond.¹⁸ The requirement of free coordination space for chelating the double bond implies the use of non-coordinating solvents. Because of oxophilic character of lanthanides ethereal solvents lead to lower N_t or to complete deactivation of catalyst by the so-called lanthanide ether cleavage (Eq. 3).¹⁹

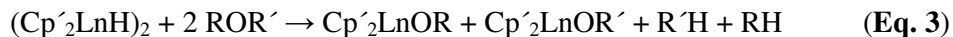

It would seem logical then to resort to catalysts with least sterically demanding ligands, thus allowing even bulky alkenes to achieve high reactivity. However, with the deployment of "lesser" cyclopentadienyl ligands side reactions occur, such as fusion of catalysts into relatively stable dimers (Eq. 4).



Compared with $[\text{Cp}_2\text{LnH}]_2$, the stability of dimers of bis(pentamethyl cyclopentadienyl) ligands $(\text{Cp}'_2\text{LnH})_2$ suffers because of larger intramolecular steric repulsions, making such catalysts more reactive towards aminoalkenes. Steric demands of such ligands on the other hand make the central metal less accessible to either amine or alkene coordination. Basically four strategies to improve accessibility have been adopted:

- Use of central metal with larger ionic radius brings ligands farther apart, thus opening up the coordination sphere. Here one should not forget the so-called "lanthanide contraction",²⁰ which lies behind the apparently illogical decrease of ionic radius with the growing atomic number (Table 5).

Table 5.

Ln	La ₅₇	Ce ₅₈	Pr ₅₉	Nd ₆₀	Pm ₆₁	Sm ₆₂	Eu ₆₃	Gd ₆₄	Tb ₆₅	Dy ₆₆	Ho ₆₇	Er ₆₈	Tm ₆₉	Yb ₇₀	Lu ₇₁
$r^{3+}[\text{m}\text{\AA}]$	1032	1010	990	983	970	958	947	938	923	912	901	890	880	868	861

The "lanthanide contraction" results from the poor shielding of the nuclear charge by $4f$ orbitals, compared with shielding efficiency of either s and p electrons.²¹ The ability of the latter to effectively shield the electric charge of protons (to some extent observed also in d -orbitals of transition metals) is the result of their closeness to the nucleus. In contrast, the less compact and more distant from the nucleus f -shell electrons "shield" the nuclear charge less effectively. In the lanthanide series starting with lanthanum up to lutetium the number of protons (as well as neutrons) in the nucleus grows, as does the positive charge, but the number of s - and p - electrons remains the same. As a result, attraction between the nucleus and electrons in f -orbitals, which are drawn closer to it, increases. However, due to their poor shielding properties, f -electrons fail to lower the effective charge on nucleus and thus shrinking the ionic radius.

- Introduction of a single sterically demanding substituent at Cp instead of five methyl groups (Cp'). For this, the most frequently used is the trimethylsilyl group. Thus a catalyst with well balanced relation of counter-acting effects of "bulky ligands" and "accessibility" is created. Whilst sufficiently bulky ligands prevent

formation of stable dimers (dimers easily decompose), increased accessibility of central metal ion favours reaction of the substrate (Scheme 8).

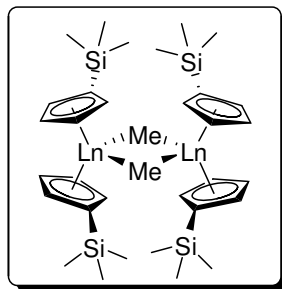

Scheme 8

- A fairly often used possibility is the use of so-called slanting, or bridged pentamethyl cyclopentadienyl ligands. The two cyclopentadienyl subunits are in most cases connected by a dimethylsilyl bridge. The bridge forces aromatic rings into a slanting position, thus opening up room for interaction of substrate with the central lanthanide metal (Scheme 9).

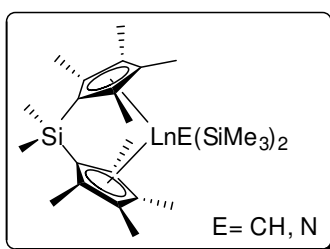

Scheme 9

- The last of the routinely used options is the use of so-called CGC (constraint geometry catalysts). In this case one of the Cp' units of catalyst has been replaced by a *tert*-butylamine residue, connected with Cp' units by a dimethylsilyl bridge (Scheme 10).

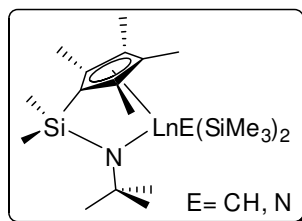

Scheme 10

Dowdy and Molander presented²² hydroamination catalyzed by lanthanide catalysts derived from Marks' complexes. The most important point here is the fact that authors cyclized even 2,2-disubstituted and hence sterically more encumbered aminoalkenes. They carried out also a double domino hydroamination and by monitoring the reaction determined its regioselectivity (Table 4, entries 199 and 200). Interestingly, a substrate without activation effects on the chain (*i.e.*, the *gem*-dimethyl or the Thorpe-Ingold effect) cyclized first at the more sterically hindered C=C bond and only then the secondary amine was added to the terminal double bond. They also managed to stop the reaction, after comparably long reaction times, in the first or in

the second stage by selection of the central metal ion (Table 4, entries 197 and 198). These reactions obey the above mentioned theory concerning improvement of central metal accessibility by changing its ionic radius. Since Sm^{3+} has smaller ionic radius than Nd^{3+} , it is more shielded by its ligands.

The 1,2-bis(indenyl)ethane catalysts,²³ developed by the Marks' group, can too be considered analogues of metallocene Cp or Cp' catalysts (Scheme 11).

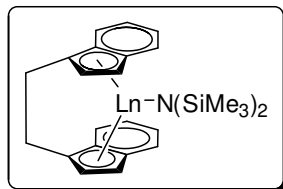

Scheme 11

In 1999, Marks repeated the scenario of his first hydroamination and the GCG catalyst (Scheme 10), found active in polymerizations of alkenes, was now applied in experiments with aminoalkenes.

In the role of the sterically less demanding and more electron-deficient ligand (compared with Cp'₂ catalysts) Marks used $[\text{Me}_2\text{Si}(\text{C}_5\text{Me}_4)(t\text{-BuN})]\text{LnE}(\text{TMS})_2$ (Ln=Nd, Sm, Yb, Lu; E=N, CH).²⁴ At 25 °C such catalysts are more active (Table 4, entries 38–42 vs. 53–56) and in hydroamination of secondary aminoalkene give on average better values of diastereoselectivity *cis*- vs. *trans*-2,5-dimethylpyrrolidine (Table 4, entries 170–172 and 174–179 vs. 181–184).

Exchanging the lanthanide central metal for an actinide metal, Marks carried out the first actinide-catalyzed intramolecular hydroamination.²⁵ Although he did get products of hydroamination, actinides failed to bring any significant advantages, as their reactions are two orders of magnitude slower than comparable lanthanide-catalyzed reactions. Catalyst **20** also may be classified among the CGC catalysts. Titanium analogue of this catalyst has been very active in co-polymerization of ethylene and 1-octene.²⁶ Authors assumed that increased electron density at the central metal ion, caused by the presence of pyrrolidine at position 3 of indenyl, can account for this finding (Scheme 12).

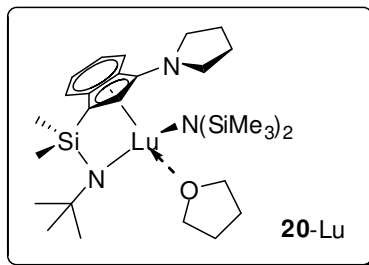

Scheme 12

By the applying the strategy of "widening the roof", Marks and co-workers prepared the last type of lanthanide catalysts.²⁷ They were going on the assumption that more asymmetry in the shielding of central metal would lessen the degree of catalyst epimerization and enhance the enantioselectivity of hydroamination catalyzed by these complexes. They thus replaced the Cp' unit of chiral catalysts (Scheme 7) by octahydrofluorenyl (Scheme 13).

The enantioselectivity of aminoalkene hydroaminations catalyzed by these reagents (up to 46% *ee*) however remained inferior to that achieved by Cp'(CpR*)LnN(TMS)₂ catalysts (up to 72% *ee*). Marks

assumed that only average enantioselectivity was the consequence of catalyst epimerization. Under the conditions of hydroamination, the initial protonolytic elimination of $\text{HN}(\text{TMS})_2$ from the substrate is followed by a conversion of precatalyst into the lanthanide-amidoalkenyl complex, the true catalyst. The reaction mixture contains a several fold excess of substrate, which can act as competing ligand; moreover the central metal ion remains coordinatively unsaturated. According to Marks, the Ln-CpR^* bond is protonated to form a lanthanide-bisamidoalkenyl complex. In this complex, rotation around Si/CpR^* bond is possible. It is this rotation, followed by elimination of one molecule of substrate acting as ligand, that leads to the formation of the other enantiomer (Scheme 14). Marks observed epimerization in lanthanocene catalysts $\text{Me}_2\text{Si}(\text{OHf})\text{CpR}^*$ and $\text{Me}_2\text{SiCp}^*\text{CpR}^*$, characterized by different reaction equilibrium constants and different (*S*)- a (*R*)-epimer ratios. The prevalence of one enantiomer of the catalyst depends on the chiral auxiliary R^* . In case $\text{R}^* = (-)$ -menthyl or $(-)$ -phenylmenthyl, there is prevalence or (*S*)-epimer, while $(+)$ -neomenthyl favours the (*R*)-epimer.

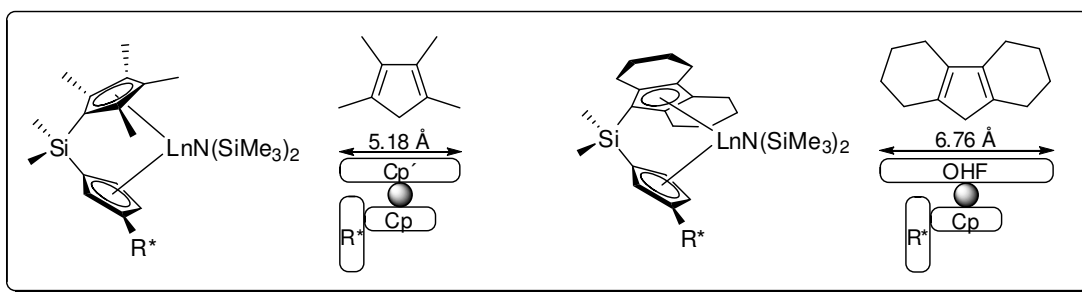

Scheme 13

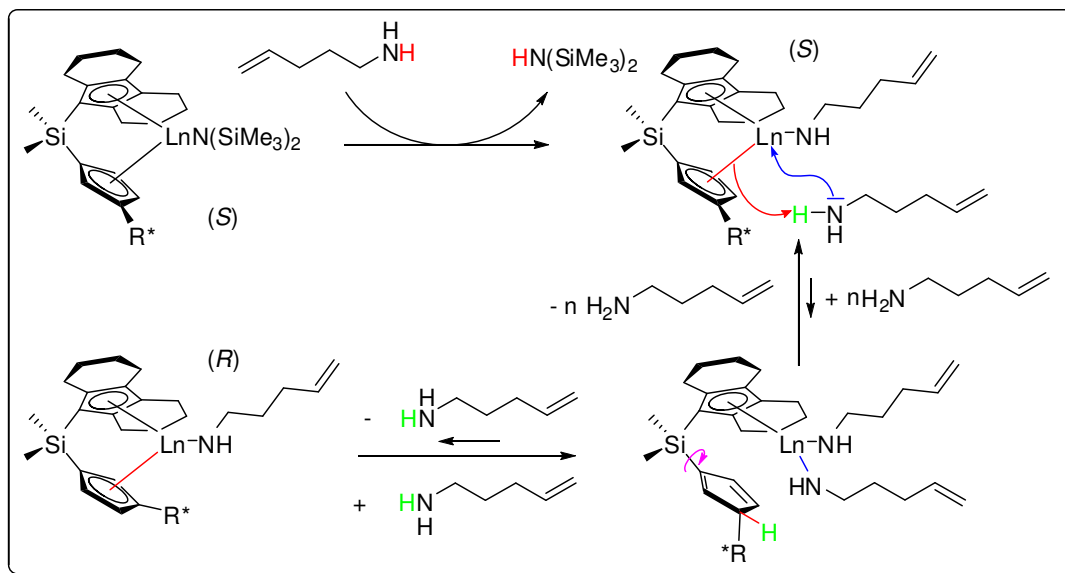

Scheme 14

The group of non-metallocene catalysts is dominated by Ln-amides, Ln-oxides and Ln-phosphides. The simplest Ln-amide catalysts are complexes of the type $\text{Ln}[\text{N}(\text{TMS})_2]_n$, wherein $\text{Ln} = \text{Nd}$ ($n=3$),²⁸ or $\text{Ln} = \text{Sm}$ ($n=2,3$).²⁹ They distinguish themselves by structural simplicity paired with catalytic efficiency. The conversion of terminal aminoalkenes with one activation substituent on the chain takes from 1.5 hours to 7 days at 90 °C (Table 4, entries 30–32, 179). Two activation substituents significantly shorten the reaction time (Thorpe-Ingold effect) even at lower temperatures (Table 4, entries 57, 119 and 161). The catalysts

Nd[N(TMS)₂]₃ allows cyclization of aminoalkene with 2,2-disubstituted C,C-unsaturated bond (Table 4, entry 208). Markó²⁹ used Sm(II)- as well as Sm(III)-catalysts (Table 4, entries 119, 161, 21–220). Although Markó in his paper assumed that the active catalytic complex had been an Sm(III)-amide, he failed to explain its formation from a Sm(II)-derivative. The single most significant contribution of the Markó's paper is the method of *in situ* generation the Sm[N(TMS)₂]_n catalyst in the reaction mixture. For this, he used the commercially available standardized SmI₂ solutions and NaN(TMS)₂ in THF, which mixes in the ratio *n* NaN(TMS)₂+SmI_n and uses as a reaction mixture to which substrate is added. This procedure greatly simplifies the manipulation with catalyst making either the Schlenk technique or the use of "dry box" redundant.

Out of the group of lanthanide-amide catalysts, the most widely used are amides substituted by *N*-aryl,^{30,31} substituted aryl,^{32,33} alkyl^{31,34–36} or cycloalkyl³⁶ (Scheme 15).

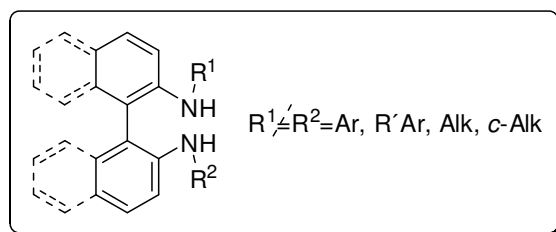

Scheme 15

Diphenylamide ligands^{32,33} (Scheme 16), tested in hydroamination of 2,2-dimethylpent-4-enylamine (**3**) showed under *par* enantioselectivities (*ee*=18–34%) and also relatively low activity. A successful reaction requires temperature of 60 °C, hydroamination nevertheless proceeds rather slowly, reaching total conversion of substrate only after 5–7 days (Table 4, entries 58, 59 and 64).

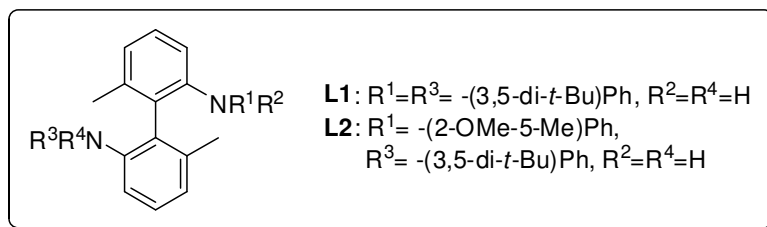

Scheme 16

Markedly higher selectivities of hydroamination are achievable with sterically more demanding binaphthylamide-lanthanide ligands^{30,31,34–36} (Scheme 17). Enantioselectivities and reaction times cover a rather broad interval of 1–85% *ee* and 0.5 hours to 16 days, respectively (Table 4).

Steric demands of the ligand (in this case depending on substituents R¹ and R²) do not constitute the most important factor enhancing the enantioselectivity of transformation. Thus sterically most encumbered ligands **36** and **37** gave but average, or even less than average enantioselectivities (Table 4, entries 113–116, 132–135, 153–156). Evidently the relative proximity of substituents at nitrogen of binaphthylamine plays a more important role. Secondary alkyls (*-i*-Pr, *-Cy*, *-c-C₅H₉*) (Table 4, entries 88–91, 118, 129–131, 137, 149–152, 158, 163–166) bring about higher enantiomeric excesses of products than do primary alkyls (*-CH₂-t-Bu*, *-CH₂-i-Pr*) (Table 4, entries 117, 136, 143–148, 157). In this group of catalytic complexes, several tendencies can be discerned. There is, on the one hand a much more marked Thorpe-Ingold effect of

the *gem*-diphenyl vs. *gem*-dimethyl group on the reaction rate (Table 4, entries 91 vs. 131). At the same time, combination of the *gem*-diphenyl group with aromatic substituents at binaphthyl nitrogen, compared with *gem*-dimethyl, brings about not only shorter reaction times, but higher enantioselectivities as well (Table 4, entries 113 vs. 132, 116 vs. 136). In compliance with the theory relating the rate of cyclization to the bond angle between activating substituents on the substrate hydroaminations in substrates carrying activating *-c-C₅H₉* substituent are accelerated over those carrying a *-Cy* substituent (Table 4, entries 164 vs. 151).

Another members of the group of nitrogen ligands, prepared *in situ*, are C₂-symmetric substituted bis-oxazolines³⁷ (Scheme 18). Depending on the substituents in positions C-4 and C-5, enantioselectivity reaches values from 6 to 67% at N_t=0.09-660h⁻¹. The most active commercially available ligand (4*R*,5*S*)-Ph₂BoxH (**L9**) showed in the cyclization of 2,2-dimethylpent-4-ene-1-amine (**3**) also the highest values of *ee* (67%) (Table 4, entries 27, 76–87, 128).

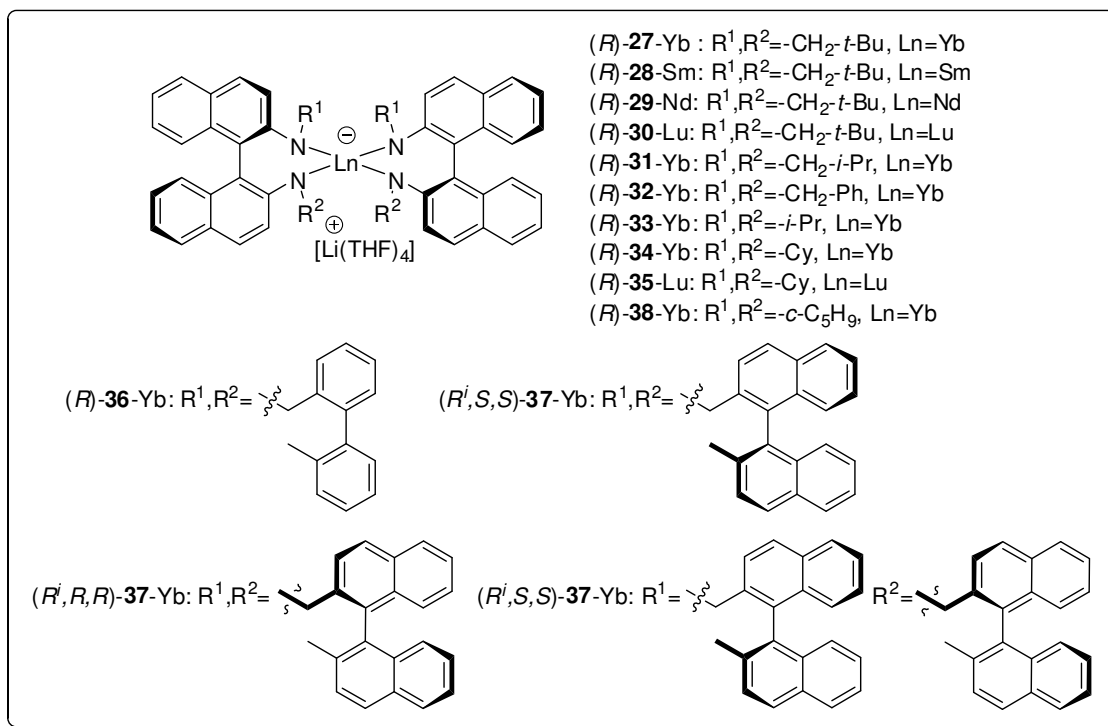

Scheme 17

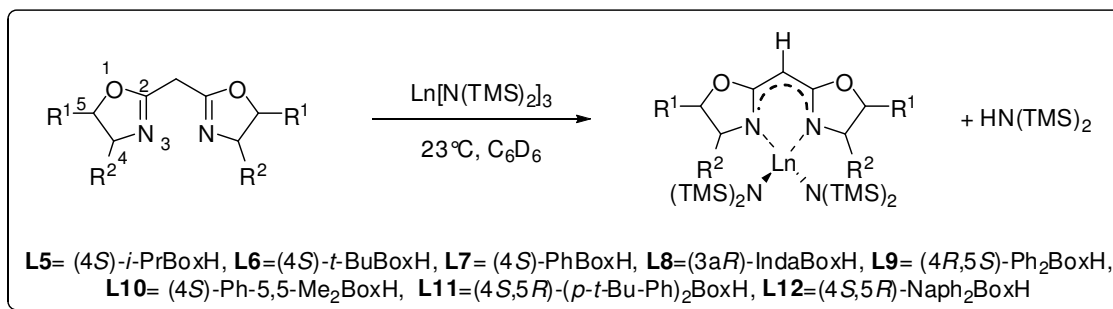

Scheme 18

Bis(phosphinimino)methanides, two-valent ligands for lanthanides,^{38,39} showed rather low activities. Low yields and low N_t values at relatively high reaction temperatures, even with the synergic Thorpe-Ingold effect, significantly diminish the synthetic attractiveness of these ligands. Their arguably single positive

feature is the possibility of one-pot preparation of catalyst from the commercially available raw materials (Scheme 19, Table 4, entries 63, 138, 140, 159, 160).

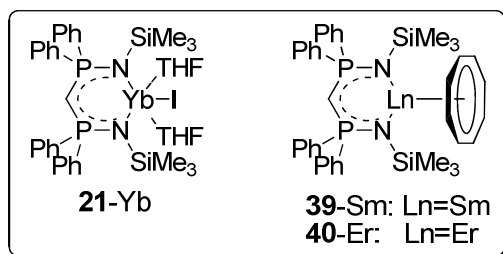

Scheme 19

Similarly, bis(thiophosphinic)amidates⁴⁰ as lanthanide ligands in hydroamination reactions require elevated reaction temperatures. Compared with the previously mentioned complexes, they are more active and at the same reaction temperature require shorter reaction times (Scheme 20).

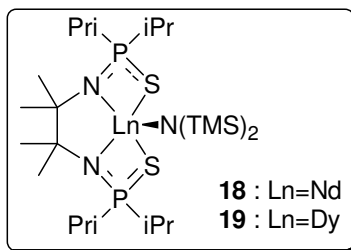

Scheme 20

The best choice so far proved to be binaphthol ligands. They are stable under the conditions of hydroamination, so that epimerization is no issue, they give good enantioselectivities and their activity is comparable to that of lanthanocene complexes. This group of phosphine oxide and phosphine sulphide derivatives⁴¹ offer fewer advantages (Scheme 21), mainly because of their lower activity and below average to good enantioselectivities (0.8–65% *ee*) (Table 4, entries 92–112).

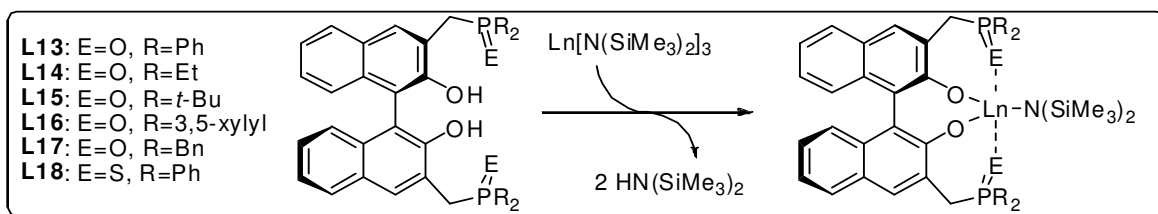

Scheme 21

Binaphthyl-Ln-phenyl complexes⁴² (Scheme 22) work better not only because of their higher activity, but also because high achieved values of enantioselectivity (Table 4, entries 24–26, 75, 76, 126, 127, 141, 142, 206, 207). By the action of the catalytic complex (*R*)-**25**-Lu on 2,2-diphenylpent-4-ene-1-amine at 25 °C, authors could quickly generate the product (*S*)-2-methyl-4,4-diphenylpyrrolidine with the so far highest *ee*=93% (Table 4, entry 126).

In spite of their high activity, bis-phenol ligands have shown extremely low enantioselectivity.^{43,44} Thus even though they can be easily synthesized, in practical application they were completely overshadowed by binaphthol ligands (Scheme 23).

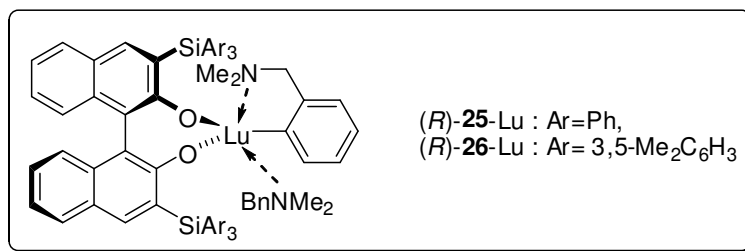

Scheme 22

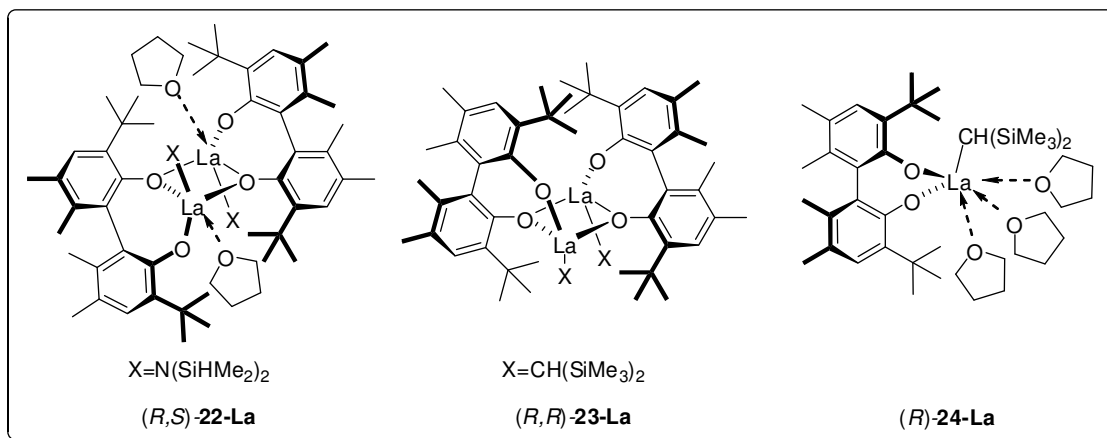

Scheme 23

Low to good enantioselectivities have been characteristic also of diphenylamines substituted by phenols (Scheme 24). At 70 °C ligands are moderately active and afford enantiomeric enrichment of about 61% *ee* (Table 4, entries 65–68).

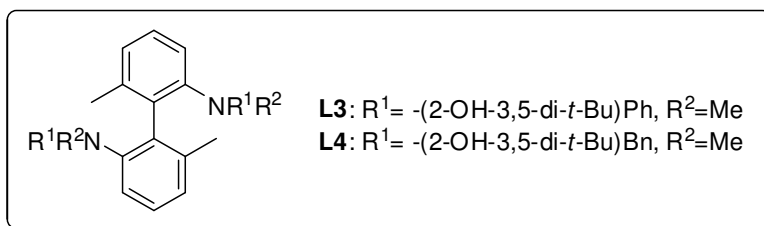

Scheme 24

2.2.2. Synthesis of piperidines and azepanes

Similarly as in alkali metal catalysis lanthanide-catalyzed hydroaminations giving rise to 6- and higher-membered heterocycles are much less common than analogous preparations of pyrrolidine rings. Because papers with this topic are few and far between there are not nearly enough empirical results to allow too many trends to be recognized from Table 6. Thus, once again the Thorpe-Ingold effect positively affects the reaction rate (Table 6, entries 2, 3 vs. 10, 11), (Table 6, entries 6 vs. 18).

At the moment, it is impossible to formulate any rules governing the substituent influence on *ee* in the final reaction mixture. Although there were several cases when their introduction increased the enantioselectivity (Table 6, entries 6 vs. 18), in others enantiomeric enrichment in the mixture of adducts decreased (Table 6, entries 3 vs. 11). The reaction could be accelerated by increasing the temperature without affecting the final *ee* (Table 6, entries 17 and 18).

Enantiomeric excess in hydroaminations could be improved by deploying more sterically encumbered ligands, albeit at the cost of lower reaction rates (Table 6, entry 2 vs. 3).

Even hydroamination of 2,2-disubstituted terminal olefin is possible, provided higher temperature and higher amount of catalyst are used to achieve acceptable reaction rates.

Cp'₂-lanthanide pre-catalysts are capable of converting bis-alkenyl substrate to a bicyclic product (Table 6, entries 40, 41), tolerating thereby a suitably protected OH group at the substrate (Table 6, entries 40, 41).⁴⁵

Interestingly, no hydroaminations of *N*-disubstituted substrates leading to *N*-protected piperidines have been published.

When a comparison is made between hydroamination leading to pyrrolidines *versus* hydroaminations leading to piperidines, the following trends can be discerned: hydroaminations leading to piperidines proceed 1-2 orders of magnitude slower than analogous hydroaminations leading to pyrrolidines (Table 4, entries 1, 2 vs. Table 6, entry 5).

So far no general rule describing the effect of chain length on *ee* could be formulated. Sometimes chain lengthening leads to lower *ee* (Table 4, entries 25, 26 vs. Table 6, entries 2, 3), sometimes to higher *ee* (Table 4, entry 153 vs. Table 6, entry 20, or Table 4, entries 60, 61 vs. Table 6, entries 17, 18).

In most cases, hydroaminations give rise to *cis*-2,6-dimethylpiperidine and *trans*-2,5-pyrrolidine.

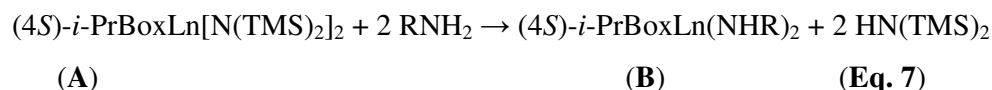
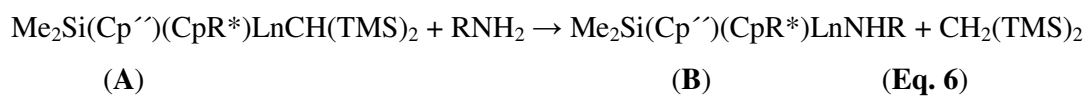
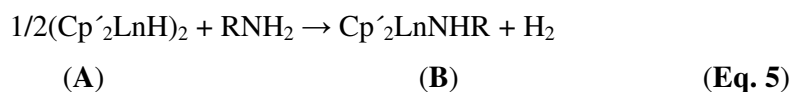

The postulated mechanism of hydroamination is as follows: in its first step hydroamination involves the reaction of lanthanide salt (**A**) with the substrate (RNH₂), giving rise to active catalytic complex (**B**) (Equations 5–7):



Next comes the rate determining step, in which olefin is inserted into the Ln-N bond, breaking the olefinic π -bond as well as the Ln-N bond and making new ones, namely C-N and Ln-C bonds. The originally acyclic molecule of substrate has been transformed into a heterocyclic one (**C**). Its organometallic bond with another molecule of substrate is lost by fast ligand exchange, followed by hydrogen transfer from nitrogen of aminoalkene to the carbon of heterocycle. As a result a cyclic product of hydroamination is formed and the catalytic complex regenerated (**B**) (Scheme 25).

The addition of amine -NH₂ group to olefin has been confirmed also by cyclization of deuterated ND₂ substrate,¹⁵ in the product of which deuterium was found at the terminal carbon of the original C=C double bond.

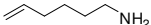
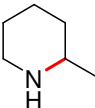
Table 6.

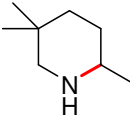
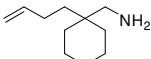
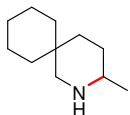
E	Catalyst/%	Substrate	Product	Y (%)	Solvent	N_t [h^{-1}]	T [$^{\circ}C$]	t [h]	Comment	Ref.
1	1.1xL15+Lu[N(TMS) ₂] ₃ /5			30 ^a	C ₆ D ₆	0.074	60		<i>ee</i> =24 (<i>S</i>)	41
2	(<i>R</i>)-25-Lu/2			95 ^a	C ₆ D ₆	4	80	14	<i>ee</i> =40 (<i>S</i>)	42
3	(<i>R</i>)-26-Lu/2			94 ^a		2.1		21	<i>ee</i> =55 (<i>S</i>)	
4	Cp*Sm(THF) ₂ / ₅			100 ^a	HCS	1	60			14
5	(Cp*LaH) ₂ / ₅			100 ^a	HCS	5	60			13
6	(OHf)-8-Sm/<3			100 ^a	C ₆ D ₆	6.6	60		<i>ee</i> =10 (+)	44
7	1.1xL13+La[N(TMS) ₂] ₃ /5			56 ^a	C ₆ D ₆	0.049	120		<i>ee</i> =1.5 (<i>S</i>)	41
8	1.1xL14+La[N(TMS) ₂] ₃ /5			98 ^a		2.3	120	<i>ee</i> =5.4 (<i>S</i>)		
9	1.1xL14+Nd[N(TMS) ₂] ₃ /5			98 ^a		0.13	60	<i>ee</i> =3.1 (<i>R</i>)		
10	(<i>R</i>)-25-Lu/2			96 ^a	C ₆ D ₆	6.4	60	7.5	<i>ee</i> =42 (<i>S</i>)	42
11	(<i>R</i>)-26-Lu/2			97 ^a		6.8		7.5	<i>ee</i> =40 (<i>S</i>)	
12	1.2XI9+La[N(TMS) ₂] ₃ /5			88	C ₆ D ₆	4	60		<i>ee</i> =56 (<i>S</i>)	37
13	Sm[N(TMS) ₂] ₂ /10			92 ^b	toluene		80	48		23
14	(<i>S</i>)-8-Sm/<2.5			100 ^a	pentane	2	25		<i>ee</i> =15 (-)	17
15	(<i>R</i>)-9-Sm/(<i>R</i>)-10-Sm/<2.5 ^c			100 ^a			25	<i>ee</i> =17 (-)		
16	(OHf)-8-Sm/<3			100 ^a	C ₆ D ₆	0.6	25		<i>ee</i> =41 (+)	27
17	(OHf)-17-Lu/<3	89.4	60			<i>ee</i> =43 (+)				
18	(OHf)-8-Sm/<3	—	60			<i>ee</i> =15 (+)				
19	(<i>R'</i> , <i>S,S</i>)-37-Yb/6			100 ^a	C ₆ D ₆		25	18	<i>ee</i> =43	30
20	(<i>R'</i> , <i>R,R</i>)-37-Yb/6			89 ^d		8.5		<i>ee</i> =38		
21	(<i>R'</i> , <i>S,R</i>)-37-Yb/6			100 ^a		27		<i>ee</i> =44		
22	(<i>R</i>)-36-Yb/6			100 ^a		45		<i>ee</i> =44		

E	Catalyst/%	Substrate	Product	Y (%)	Solvent	N _t [h ⁻¹]	T [°C]	t [h]	Comment	Ref.
24	(R)-32-Yb/6			100 ^a	C ₆ D ₆		25	130	ee=39	41
25	(R)-38-Yb/4			100 ^a	C ₆ D ₆		60	40	ee=51	36
26	(R)-27-Yb/4			100 ^a			60	16	ee=30	
27	(R)-34-Yb/6			85	C ₆ D ₆		60	66	ee=45	35
28	(R,R)-23-La/2			>96 ^a	C ₆ D ₆	3.5	80	38	cis:trans=3.7:1	44
29	(R)-24-La/2			87 ^a		3.8		42	cis:trans=4:1	
30	18-Nd/5			97	C ₆ D ₆		120	2	cis:trans=6:1	40
31	19-Dy/5			9				1	cis:trans=5:1	
32	Cp'₂NdCH(TMS)₂/6			97	C ₆ D ₆		r.t.	12	cis:trans=115:1	45
33	Cp'₂NdCH(TMS)₂/9			89	C ₆ D ₆		r.t.		cis:trans=>100:1	
34	Cp'₂NdCH(TMS)₂/6			90	C ₆ D ₆		r.t.	2	cis:trans=>100:1	
35	Sm[N(TMS)₂]₃/10			46 ^a	THF		60	24		29
36				82	THP		90	24	cis:trans=5.7:1	
37	[(Cp ^{TMS})₂NdMe]₂/10.5			94	C ₆ D ₆		120	0.083		22
38	[(Cp ^{TMS})₂NdMe]₂/8			97	C ₆ D ₆		120	48		

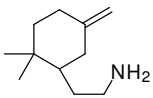
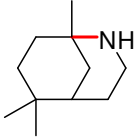
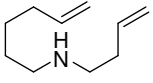
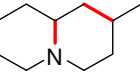
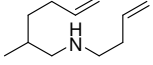
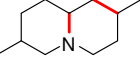
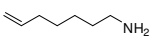
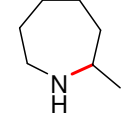
E	Catalyst/%	Substrate	Product	Y (%)	Solvent	N_t [h^{-1}]	T [$^{\circ}C$]	t [h]	Comment	Ref.
39	$[(Cp^{TMS})_2NdMe]_2/14$			91	C_6D_6		120	72		22
40	$Cp'_2SmCH(TMS)_2/9$			90	C_6D_6		50	24		45
41	$Cp'_2SmCH(TMS)_2/9$			90	C_6D_6		50	18		
42	$Me_2SiCp''_2NdCH(TMS)_2/10$			100 ^a	toluene- d_8	0.3	60			15

a) Conversion determined by NMR. b) Product isolated as *N*-Ac derivative. c) Ln-alkyl and Ln-amide catalysts showed identical results.

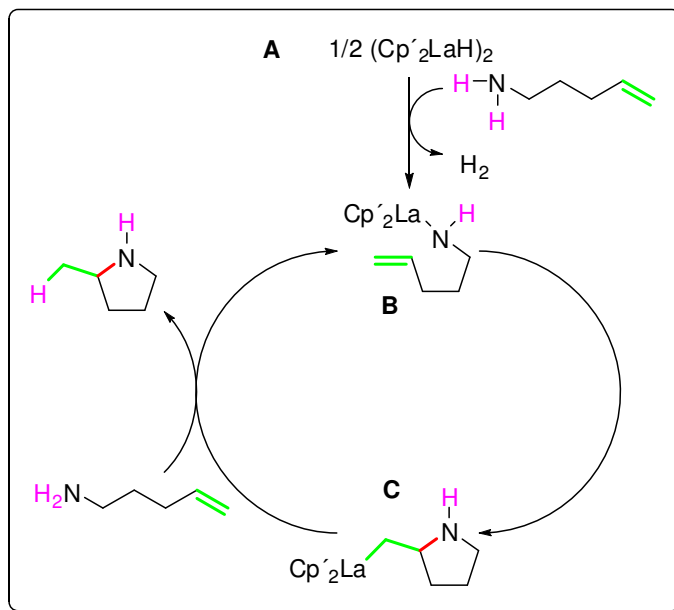

Scheme 25

Kinetic studies of hydroaminations,^{15,37} catalyzed by lanthanides have brought forth a kinetic equation (Eq. 8), common for lanthanocenes such as $\text{Cp}'_2\text{LnCH}(\text{TMS})_2$, $\text{Me}_2\text{Si}(\text{Cp}')(\text{CpR}^*)\text{LnCH}(\text{TMS})_2$, $\text{Me}_2\text{Si}(\text{Cp}')(\text{CpR}^*)\text{LnN}(\text{TMS})_2$, $\text{Me}_2\text{Si}(\text{OHf})(\text{CpR}^*)\text{LnCH}(\text{TMS})_2$, $\text{Me}_2\text{Si}(\text{OHf})(\text{CpR}^*)\text{LnN}(\text{TMS})_2$:

$$\text{Rate} = k \cdot [\text{Substrate}]^0 \cdot [\text{Catalyst}]^1 \quad (\text{Eq. 8})$$

In spite of differences in the number of molecules coordinated at the central Ln^{3+} metal and the presence of two potential catalysts $\text{BoxLn}(\text{NHR})[\text{N}(\text{TMS})_2]$ vs. $\text{BoxLn}(\text{NHR})_2$ (Scheme 26), the reaction most probably proceeds by the same mechanism, characterized by the same rate equation:

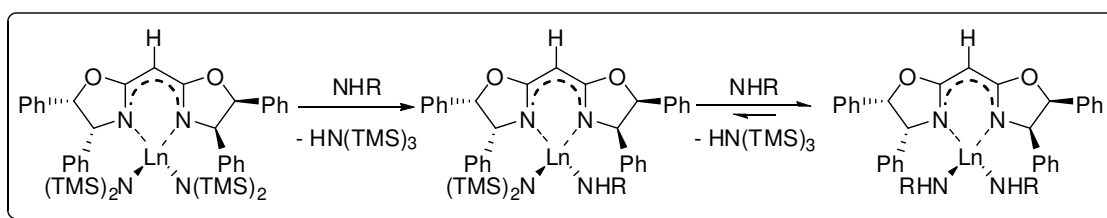

Scheme 26

An interesting feature of the cyclization of 2-aminoheptene¹⁵ is the observed progressive decrease of the *de* values of products with the time (or decreasing substrate concentration) (Scheme 27). Decreasing diastereoselectivity may be another manifestation of multiple substrate coordination at the central metal.

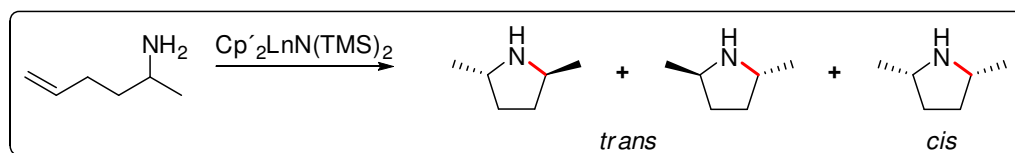

Scheme 27

At lower substrate concentrations the metal coordination number decreases too, leading to less congestion in its surroundings and consequently to lower de values. Under the reaction conditions there is no resolution, none of enantiomers of the racemic substrate is preferred.

In cyclizations catalyzed by $Cp^*_2LaCH(TMS)_2$ in THF- d_8 , reaction rates of hydroamination plummet dramatically, although not down to total inhibition. Taking into account significant differences in the respective concentrations of catalysts, substrate and THF ($[RNH_2] \approx 0.5$ M, $[Ln] \approx 0.02$ M, $[THF] \approx 12.3$ M), it is apparent that primary amines are much more strongly bound to the central metal than does THF.

Insertion of olefin in the La–N bond creates in the molecule a new stereogenic centre. The stereoselectivity of this step is usually accounted for by assuming existence of a "pseudo-chair" seven-membered (in case of piperidines eight-membered) transition state. In such a transition state the molecule of olefin approaches the central metal on a course, more or less parallel with the imaginary line connecting centres of gravity of the Cp rings (Scheme 28, **A**), or following a course perpendicular to that line (Scheme 28, **B**) (Table 4, entries 7, 8). In both cases, the energetically favourable course would be from the side opposite to the chiral auxiliary. The interaction between ligands Cp' and CpR^* respectively of pre-catalysts with S -configuration with axial hydrogens prefers in methylpyrrolidine the formation of S -enantiomer over the R -enantiomer. Similar results, albeit with lower final ee , gave these catalysts also in the preparation of piperidines (Table 6, entries 15, 16).

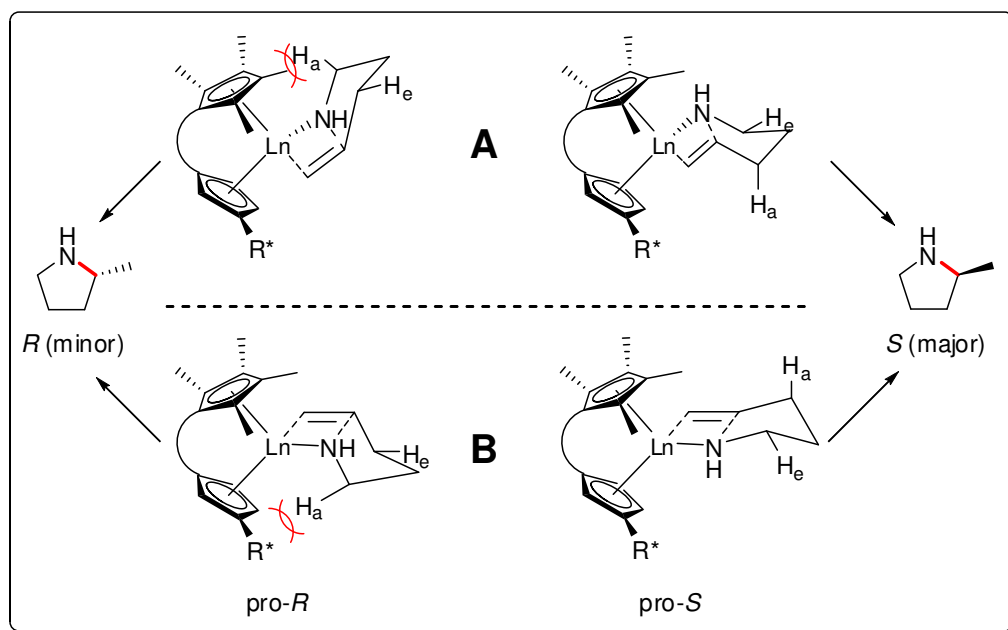

Scheme 28

3. Summary

In general, catalysts from the group of lanthanides and actinides are highly active, allowing a relatively fast transformation of aminoalkenes with non-activated terminal C=C double bond to the desired cyclic products.

To the group of successful substrates belong protected and unprotected terminal amines, secondary alkyl amines as well as cyclic amines with 2,2-disubstituted double bond. Chiral pre-catalysts give good enantioselectivities and good to excellent diastereoselectivities.

The majority of the so far published accounts have concentrated on demonstrating effectiveness of these pre-catalysts and monitoring the reaction kinetics. In the majority of these reaction the reported yields are not isolated yields, so that real data on conversion may differ significantly from the measured ones.

Pre-catalysts from this group are extraordinarily sensitive towards oxygen and moisture in system. In practical experiments this translates into lengthy and demanding purification of solvents and ligands (deoxygenation, drying) and even making the experiments in a dry-box.

Sensitivity towards oxygen drastically reduces not only the choice of solvent, but the choice of substrate as well, tolerated being only trivial, non-substituted substrates, or possibly sterically highly shielded hydroxyl groups.

Acknowledgments

This work was supported by the Science and Technology Assistance Agency under contracts No. APVV-0164-07, VMSP-P-0130-09 and the Scientific Grant Agency under contract No. VEGA 1/0340/10.

References

1. (a) Lawrence, S. A. *Amines. Synthesis, Properties and Applications*; Cambridge University Press: Cambridge, United Kingdom, 2004. (b) Nugent, T. C., Ed. *Chiral Amine Synthesis: Methods, Developments and Applications*; Wiley-VCH: Weinheim, Germany, 2010.
2. (a) Hultsch, K. C. *Org. Biomol. Chem.* **2005**, *3*, 1819. (b) Hultsch, K. C. *Adv. Synth. Catal.* **2005**, *347*, 367. (c) Müller, T. E.; Hultsch, K. C.; Yus, M.; Foubelo, F.; Tada, M. *Chem. Rev.* **2008**, *108*, 3795.
3. Aillaud, I.; Collin, J.; Hannedouche, J.; Schulz, E. *Dalton Trans.* **2007**, 5105.
4. Müller, T. E.; Beller, M. *Chem. Rev.* **1998**, *98*, 675.
5. Quinet, C.; Jourdain, P.; Hermans, C.; Ates, A.; Lucas, I.; Markó, I. E. *Tetrahedron* **2008**, *64*, 1077.
6. Widenhofer, R. A.; Han, X. *Eur. J. Org. Chem.* **2006**, 4555.
7. (a) Sammes, P. G.; Weller, D. J. *Synthesis* **1995**, 1205. (b) Jung, M. E.; Piizzi, G. *Chem. Rev.* **2005**, *105*, 1735.
8. Ates, A.; Quinet, C. *Eur. J. Org. Chem.* **2003**, 1623.
9. Quinet, C.; Ates, A.; Markó, I. E. *Tetrahedron Lett.* **2008**, *49*, 5032.
10. Crimmin, M. R.; Casely, I. J.; Hill, M. S. *J. Am. Chem. Soc.* **2005**, *127*, 2042.
11. Datta, S.; Roesky, P. W.; Blechert, S. *Organometallics* **2007**, *26*, 4392.
12. Datta, S.; Gamer, M. T.; Roesky, P. W. *Organometallics* **2008**, *27*, 1207.
13. Gagné, M. R.; Marks, T. J. *J. Am. Chem. Soc.* **1989**, *111*, 4108.
14. Gagné, M. R.; Nolan, S. P.; Marks, T. J. *Organometallics* **1990**, *9*, 1716.
15. (a) Gagné, M. R.; Stern, C. L.; Marks, T. J. *J. Am. Chem. Soc.* **1992**, *114*, 275. (b) Li, Y.; Marks, T. J. *J. Am. Chem. Soc.* **1998**, *120*, 1757.
16. Gagné, M. R.; Brard, L.; Conticello, V. P.; Giardello, M. A.; Stern, C.; Marks, T. J. *Organometallics* **1992**, *11*, 2003.
17. Giardello, M. A.; Conticello, V. P.; Brard, L.; Gagné, M. R.; Marks, T. J. *J. Am. Chem. Soc.* **1994**, *116*, 10214.
18. Molander, G. A.; Romero, J. A. C. *Chem. Rev.* **2002**, *102*, 2161.
19. Deelman, B.-J.; Booij, M.; Meetsma, A.; Teuben, J. H.; Kooijman, H.; Spek, A. L. *Organometallics* **1995**, *14*, 2306.
20. Abram, U.; Dell'Amico, D. B.; Calderazzo, F.; Della Porta, C.; Engelert, U.; Marchetti, F.; Merigo, A. *Chem. Commun.* **1999**, 2053.
21. Mikami, K.; Terada, M.; Matsuzawa, H. *Angew. Chem. Int. Ed.* **2002**, *41*, 3554.
22. Molander, G. A.; Dowdy, E. D. *J. Org. Chem.* **1998**, *63*, 8983.
23. Gilbert, A. T.; Davis, B. J.; Emge, T. J.; Broene, R. D. *Organometallics* **1999**, *18*, 2125.

24. Tian, S.; Arredondo, V. M.; Stern, C. L.; Marks, T. J. *Organometallics* **1999**, *18*, 2568.
25. Stubbert, B. D.; Stern, C. L.; Marks, T. J. *Organometallics* **2003**, *22*, 4836.
26. Seyam, A. M.; Stubbert, B. D.; Jensen, T. R.; O'Donnell III., J. J.; Stern, C. L.; Marks, T. J. *Inorg. Chim. Acta* **2004**, *357*, 4029.
27. Douglass, M. R.; Ogosawara, M.; Hong, S.; Metz, M. V.; Marks, T. J. *Organometallics* **2002**, *21*, 283.
28. Kim, Y. K.; Livinghouse, T.; Bercaw, J. E. *Tetrahedron Lett.* **2001**, *42*, 2933.
29. Quinet, C.; Ates, A.; Markó, I. E. *Tetrahedron Lett.* **2008**, *49*, 5032.
30. Aillaud, I.; Wright, K.; Collin, J.; Schultz, E.; Mazaleyrat, J.-P. *Tetrahedron: Asymmetry* **2008**, *19*, 82.
31. Collin, J.; Daran, J.-C.; Jancquet, O.; Schultz, E.; Trifonov, A. *Chem. Eur. J.* **2005**, *11*, 3455.
32. O'Shaughnessy, P. N.; Scott, P. *Tetrahedron: Asymmetry* **2003**, *14*, 1979.
33. (a) O'Shaughnessy, P. N.; Gillespie, K. M.; Knight, P. D.; Munslow, I. J.; Scott, P. *Dalton Trans.* **2004**, 2251. (b) O'Shaughnessy, P. N.; Knight, P. D.; Morton, C.; Gillespie, K. M.; Scott, P. *Chem. Commun.* **2003**, 1770.
34. Collin, J.; Daran, J.-C.; Schultz, E.; Trifonov, A. *Chem. Commun.* **2003**, 3048.
35. Riegert, D.; Collin, J.; Meddour, A.; Schultz, E.; Trifonov, A. *J. Org. Chem.* **2006**, *71*, 2514.
36. Aillaud, I.; Collin, J.; Duhayon, C.; Guillot, R.; Lyubov, D.; Schultz, E.; Trifonov, A. *Chem. Eur. J.* **2008**, *14*, 2189.
37. Hong, S.; Tian, S.; Metz, M. V.; Marks, T. J. *J. Am. Chem. Soc.* **2003**, *125*, 14768.
38. Panda, T. K.; Zulus, A.; Gamer, M. T.; Roesky, P. W. *J. Organomet. Chem.* **2005**, *690*, 5078.
39. Panda, T. K.; Zulus, A.; Gamer, M. T.; Roesky, P. W. *Organometallics* **2005**, *24*, 2197.
40. Kim, Y. K.; Livinghouse, T.; Horino, Y. *J. Am. Chem. Soc.* **2003**, *125*, 9560.
41. Yu, X.; Marks, T. J. *Organometallics* **2007**, *26*, 365.
42. Gribkov, D. V.; Hultsch, K. C.; Hampel, F. *J. Am. Chem. Soc.* **2006**, *128*, 3748.
43. Gribkov, D. V.; Hultsch, K. C.; Hampel, F. *Chem. Eur. J.* **2003**, *9*, 4796.
44. Gribkov, D. V.; Hampel, F.; Hultsch, K. C. *Eur. J. Inorg. Chem.* **2004**, 4091.
45. (a) Molander, G. A.; Pack, S. K. *J. Org. Chem.* **2003**, *68*, 9214. (b) Molander, G. A.; Dowdy, E. D.; Pack, S. K. *J. Org. Chem.* **2001**, *66*, 4344.

3,4-ETHYLENEDIOXYTHIOPHENE (EDOT), AN OUTSTANDING BUILDING BLOCK. SYNTHESIS AND FUNCTIONALIZATION

María José Mancheño, Alejandro de la Peña and José L. Segura

*Departamento de Química Orgánica I, Facultad de Ciencias Químicas, Universidad Complutense de Madrid, Avd. Complutense S/N, Madrid E-28040, Spain
(e-mail: segura@quim.ucm.es; mjmreal@quim.ucm.es)*

Abstract. *The main synthetic strategies for the synthesis of 3,4-ethylenedioxythiophene (EDOT) are reviewed together with the main functionalization reactions of EDOT described to date. The different synthetic strategies employed for the functionalization of EDOT have been divided into two main types, namely: (i) modifications in the ethylene bridge of EDOT and (ii) basic reactions in the ethylene bridge of EDOT. Therefore the main emphasis is placed upon the use of chemical synthesis for the development of EDOT derivatives and not in their properties and applications which have been already revised in different reviews and monographies which are referenced along the review.*

Contents

1. Introduction
 2. Synthesis of EDOT
 3. EDOT functionalization. New derivatives containing the EDOT unit
 - 3.1. Modifications in the ethylene bridge of EDOT
 - 3.2. Basic reactions in the thiophene moiety of EDOT
 - 3.2.1. EDOT-based oligothiényl chalcogenides
 - 3.2.2. EDOT derivatives *via* cross-coupling reactions
 - 3.2.2.1. *Via* Stille cross-coupling reaction
 - 3.2.2.2. Other cross-coupling reactions
 - 3.2.3. EDOT derivatives *via* Wittig-Horner-Emmons reactions
 4. Conclusions
- Acknowledgments
References

1. Introduction

3,4-Ethylenedioxythiophene (EDOT) has become a powerful building block for the synthesis of functional π -conjugated systems.¹ One of the major advantages of this system lies on the unique combination of strong electron-donor properties and self-structuring effects related to intramolecular non covalent interactions between oxygen and sulphur. The structure of diverse functionalized EDOT compounds has, therefore, a direct impact in the potential properties of EDOT-containing polymers as molecular functional π -conjugated systems.

In addition to its wide use for the design of functional or low-band-gap conducting polymers, EDOT has also been employed as a building block for the synthesis of a variety of molecular π -conjugated systems including fluorophores,² nonlinear optical (NLO)-phores,³ electroactive moieties⁴ and π -conjugated oligomers.⁵

The properties and applications of EDOT and PEDOT derivatives have been previously reviewed¹ and the reader is referred to these review articles to get a comprehensive overview of this field. However, to the best of our knowledge, there is no previous review on the synthetic methodologies for the synthesis of EDOT itself and its derivatives. The purpose of this account is not to duplicate those aspects previously reviewed by others¹ but to give an overview of the main synthetic strategies developed for the synthesis of EDOT itself and to revise the main functionalization reactions of EDOT described to date. Thus, we will briefly indicate the most important applications found for some of the EDOT derivatives when applicable and concentrate mainly on the synthetic aspects of the EDOT chemistry.

2. Synthesis of EDOT

The key intermediates in the most general synthetic route toward EDOT are the disodium salts of dialkyl 3,4-dihydroxy-2,5-thiophenedicarboxylates which are prepared from thiodiglycolic acid **1** (Scheme 1).^{1,6} A double Williamson etherification with this intermediates and 1,2-dichloroethylene allow to obtain EDOT as a white solid with a boiling point of 225 °C (1013 mbar) which slowly turns dark upon exposure to air and light due to partial oxidation.

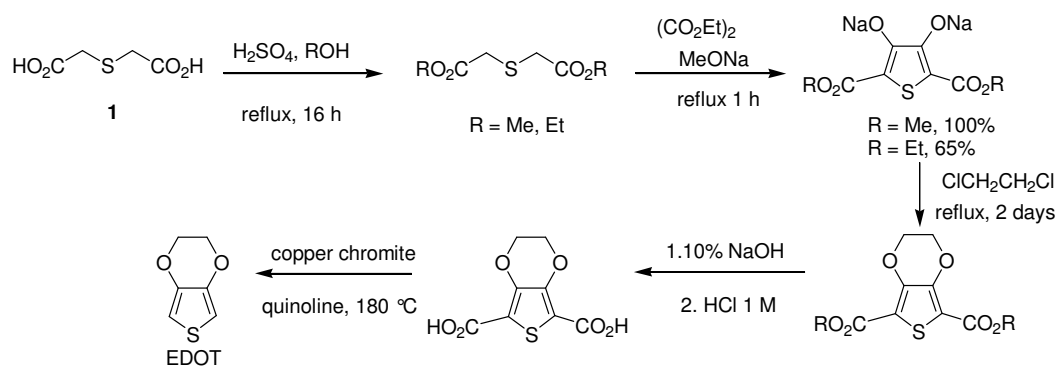

Scheme 1

Mitsunobu reactions from diethyl 3,4-dihydroxy-2,5-thiophenedicarboxylate **2** have also been used for the synthesis of EDOT and substituted EDOTs such as **3** with good yields (Scheme 2).⁷

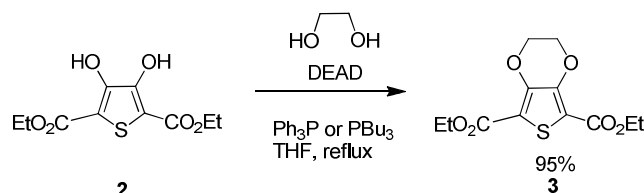

Scheme 2

Both methods use heavy metals (copper chromite or $\text{CuCO}_3/\text{Cu}(\text{OH})_2$) in the decarboxylation step and therefore the search of new environmentally friendly methods for the synthesis of EDOT is a challenge. Moreover, the purity of the EDOT is crucial for the polymerization reactions because even traces of quinoline derivatives remaining from the thermal decarboxylation will influence further polymerization steps.

An efficient synthesis of EDOT was reported by Hellberg *et al.* in 2004 based on a two-step sequence.⁸ This procedure relies on the synthesis of 3,4-dimethoxythiophene through the addition-elimination reaction

between 2,3-dimethoxy-1,3-butadiene and sulfur dichloride in hexane together with an insoluble ‘buffer’ in a 60% yield. The subsequent transesterification reaction with ethylene glycol under standard conditions (catalytic amounts of *p*-toluenesulfonic acid in refluxing toluene) afforded the corresponding EDOT in a 65% yield on a 50 mmol scale (Scheme 3).

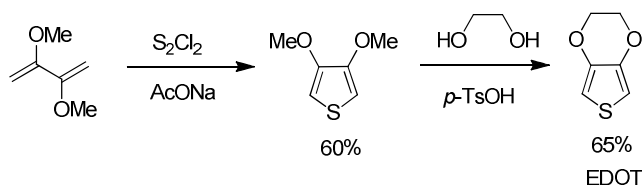

Scheme 3

Recently, a new synthesis of EDOT has been reported *via* $\text{BF}_3 \cdot \text{OEt}_2$ -catalyzed ring opening of oxiranes **4** (Scheme 4).⁹ Oxiranes **4a,b** were reacted with bromoethanol to give alcohols **5**. Subsequent intramolecular etherification of the crude alcohols **5** using KOH in EtOH gave 2,3-bis(benzyloxymethyl)-1,4-dioxanes **6a,b**. Debenzylation of **6a,b** by hydrogenation formed diols **7a,b** which were mesylated in high yield. Reaction of compounds **8a,b** with sodium sulfide nonahydrate ($\text{Na}_2\text{S} \cdot 9\text{H}_2\text{O}$) gave tetrahydrothiophenes **9**. Finally, dehydrogenation of **9a,b** with 2,3-dichloro-5,6-dicyano-1,4-benzoquinone (DDQ) gave EDOT in 21% and 40% yields, respectively.

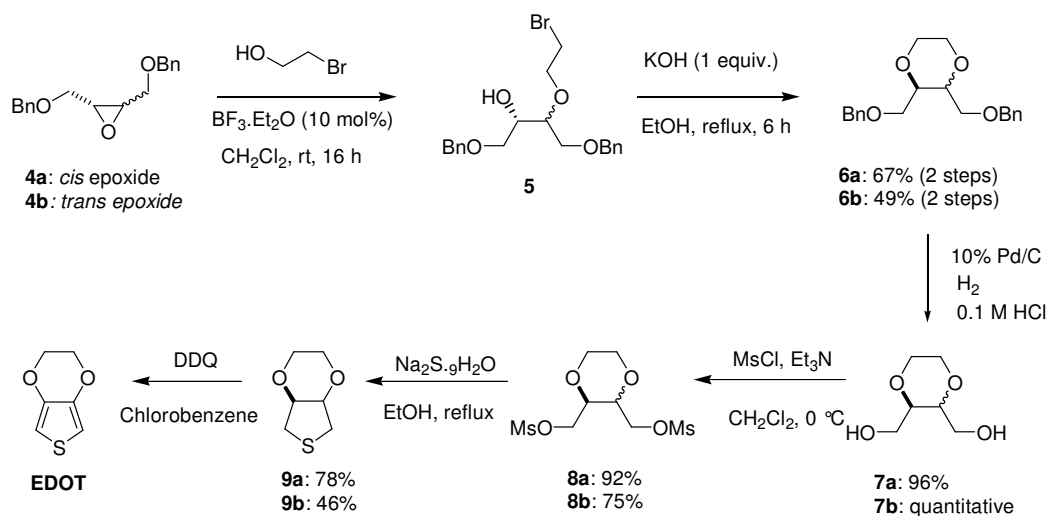

Scheme 4

Other synthetic approach, depicted in Scheme 5, has been also recently described to synthesize EDOT under mild conditions.¹⁰ Reaction of tribromoacetaldehyde and ethylene glycol, followed by treatment with PCl_5 and sodium ethoxide, yielded dialkene **10**. Reaction of compound **10** with 5 equivalents of *n*-BuLi, followed by addition of trimethylsilylchloride, gave diyne **11** in 89% yield. The subsequent synthesis of EDOT was accomplished by zirconocene dichloride-mediated cyclization reaction of the diyne **11**, followed by treatment with disulfur dichloride (S_2Cl_2) and further protodesylation with tetrabutylammonium chloride in good yield.

In conclusion, different efficient synthesis of 3,4-ethylenedioxythiophene (EDOT) have been reported. The most common and industrially applied route is still the double Williamson etherification depicted in Scheme 1. However, the major drawback of this method as well as that of the efficient Mitsunobu reaction

route (Scheme 2) is the use of heavy metals in the decarboxylation step. Therefore, new routes have been implemented in the last years as interesting alternatives for the preparation of EDOT itself, as long as for the design of new EDOT derivatives.

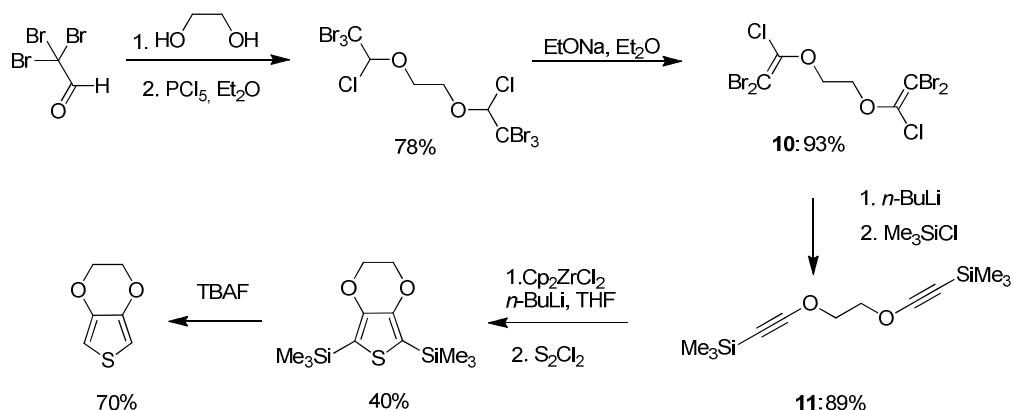

Scheme 5

3. EDOT functionalization. New derivatives containing the EDOT unit

Modification of the EDOT structure has been performed in the search of new physicochemical and electronic properties. A great variety of derivatives of this versatile building block has been synthesized and the main functionalization reactions of EDOT described to date will be revised in the following sections.

3.1. Modifications in the ethylene bridge of EDOT

It has been considered highly valuable to install a variety of substituents on the dioxane ring of EDOT in order to control the electronic or chemical properties of PEDOT but the routes towards them are pretty limited until now.

One of the simplest modifications of EDOT involves the introduction of alkyl chains in the ethylene bridge. In this sense, multiple alkyl derivatives have been introduced, some of them with the aim of synthesizing soluble conjugated polymers.¹ Many examples involve the hydroxymethyl-EDOT derivative **12** (Scheme 6)¹¹ which can be functionalized through direct esterification, Mitsunobu or by a Williamson etherification reaction.^{1,12,13}

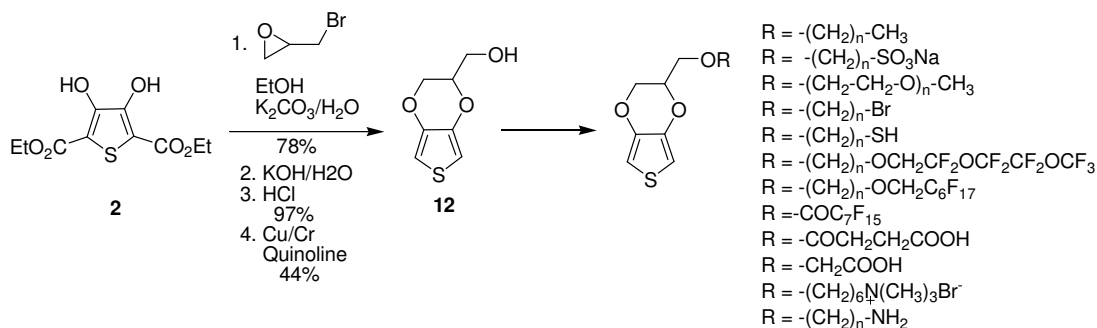

Scheme 6

By using this procedure, EDOT derivatives bearing biotin or oligonucleotides have been obtained as materials for the design of microelectrodes.¹⁴ Additionally, a titanocene dichloride complex has been also incorporated through alcohol **12**.¹⁵

The functionalized EDOT derivative **13**, depicted in Scheme 6, may also serve as precursor of new tailor-made EDOT derivatives. For instance, EDOT derivative **14** with a 1,4,8,11-tetraazacyclotetradecane (cyclam) ligand pendant to the ethylene bridge **14** as well as its complexes $[M(\mathbf{10})(\text{BF}_4)_2]$, where $M(\text{II})=\text{Cu}(\text{II})$, could be prepared by nucleophilic substitution on **13** (Scheme 7).¹⁶

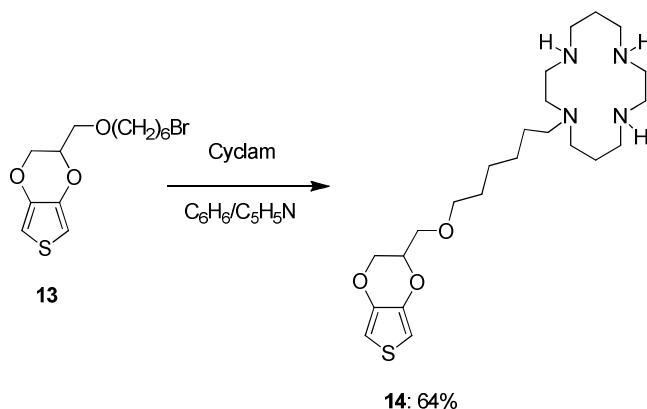

Scheme 7

Chloro and bromomethyl-EDOT derivatives **15** and **16** are another interesting building blocks toward bridged functionalized EDOTs. Their syntheses have been described by acid-catalyzed transesterification reaction of 3,4-dimethoxythiophene and the corresponding diol in refluxing toluene (Scheme 8).¹⁷

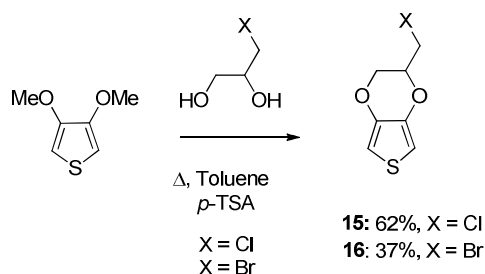

Scheme 8

Activated EDOT derivative **15** can be easily reacted with many functional groups through typical nucleophilic substitution reactions. Thus, derivative **15** has been conveniently used to prepare EDOT monomers functionalized with electron-accepting systems,^{17,18} such as perilenediimides (PTCDI) **17**, 9,10-anthraquinones (AQ) **18** or **19** and 11,11,12,12-tetracyano-9,10-anthraquinodimethane (TCAQ) **20** (Scheme 9).

The versatility of chloro and bromomethyl-EDOT **15** and **16**, respectively, as building blocks for substituted EDOTs may also be exemplified in the “click reactions” of azidomethyl-EDOT **21** (N_3 -EDOT) with different terminal alkynes **22** to obtain the corresponding 1,2,3-triazolo-substituted EDOTs **23**, via “click reaction” in 64–84% yields (Scheme 10).^{19,17c}

Electroactive systems in aqueous media based on EDOT have been prepared using also chloromethyl derivative **15** as an intermediate. EDOT derivatives covalently linked to the nucleobase uracil were obtained as a mixture of *N*-1-alkylated uracil **24** and *N,N'*-dialkylated derivative **25** in 31% and 14% yields, respectively (Scheme 11).²⁰

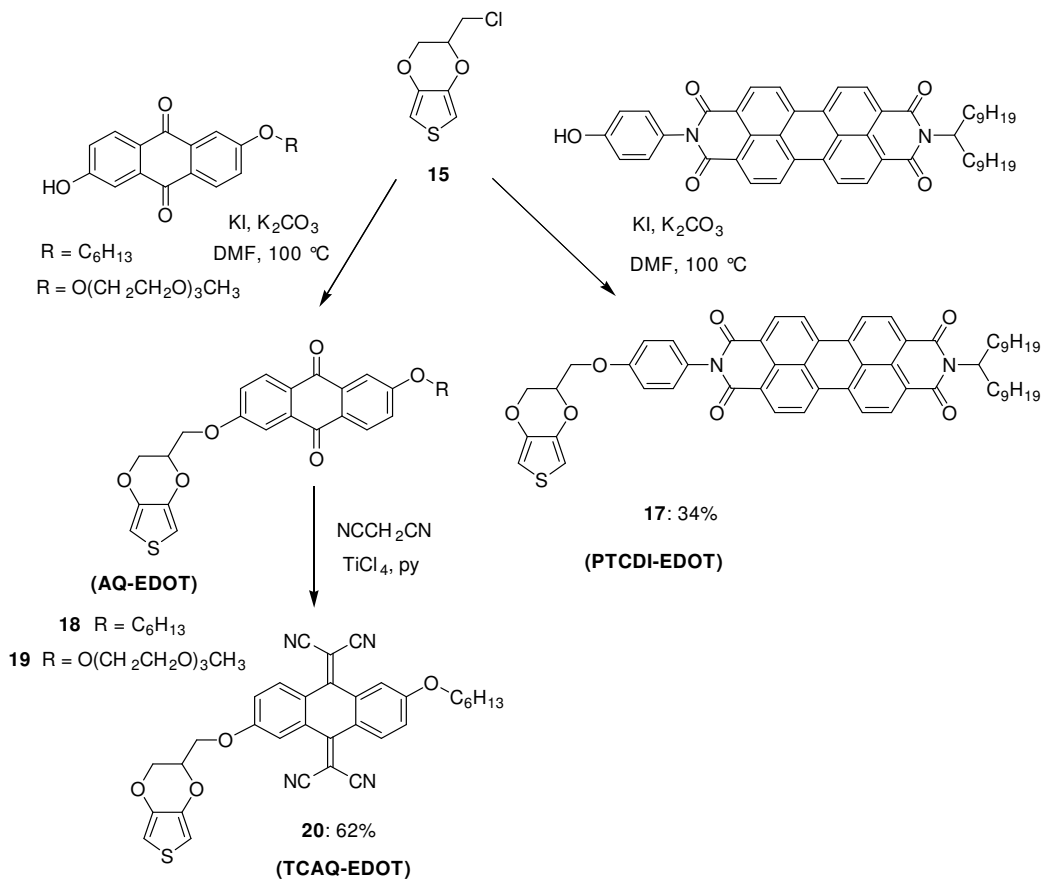

Scheme 9

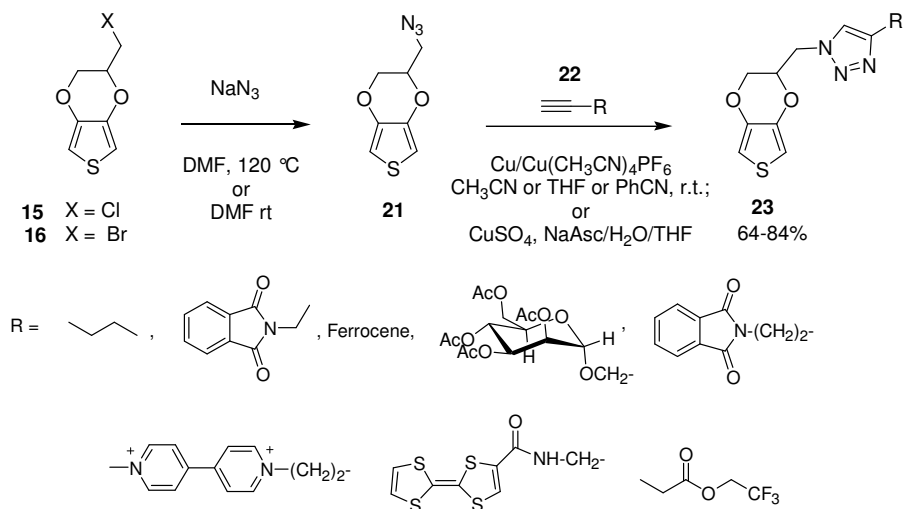

Scheme 10

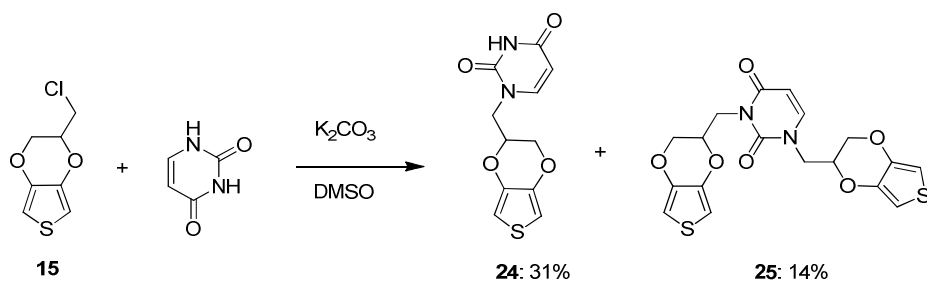

Scheme 11

New EDOT derivatives endowed with imidazolium-ionic liquid with different anions were also synthesized as functional monomers from chloromethyl derivative **15**.²¹ EDOT-ImCl **26** was obtained by reaction of compound **15** with an excess of 1-methylimidazole in 95% yield. Further exchange of the chloride anions by different anions such as tetrafluoroborate (BF₄), bis(trifluoromethane)sulfonimide [(CF₃SO₂)₂N] and hexafluorophosphate (PF₆) gave the corresponding EDOT derivatives **27** (Scheme 12).

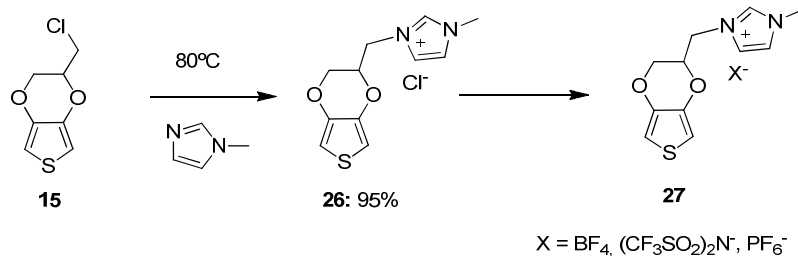

Scheme 12

By using the chloromethyl derivative **15**, phosphine ligands bearing 3,4-ethylenedioxythiophene (EDOT) groups, in which a Ph₂P group is connected to the EDOT ethylene bridge *via* a methylene (**28**) or longer ‘spacer’ (**29**), have been prepared together with their *cis*-[MCl₂(L)₂] (M=Pd and Pt) complexes (Scheme 13).²²

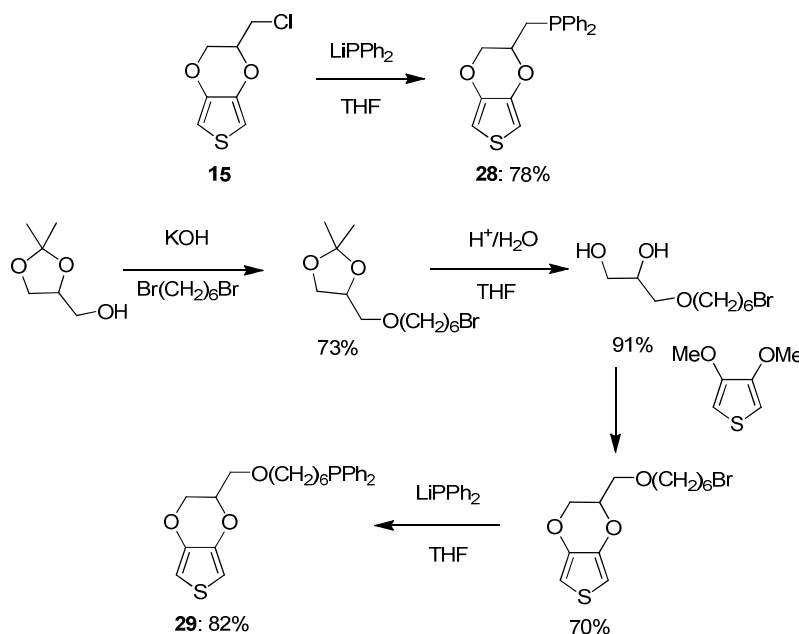

Scheme 13

The functionalized ethylenedioxythiophene (EDOT) derivative **30** bearing a highly nucleophilic thiolate group constitutes another interesting derivative to provide new functionalized EDOTs,²³ as demonstrated in tetrathiafulvalene chemistry,²⁴ or with the thiophene unit itself.²⁵ The key point of this strategy lies on an efficient protection of the thiolate anion with a cyanoethyl group, which then can be very easily cleaved by treatment under mild basic conditions. The efficiency of this new building block as a precursor of a wide range of EDOT-based monomers is demonstrated by its reaction with a variety of electrophilic species or by its oxidation to a disulfide dimer **31** (Scheme 14).

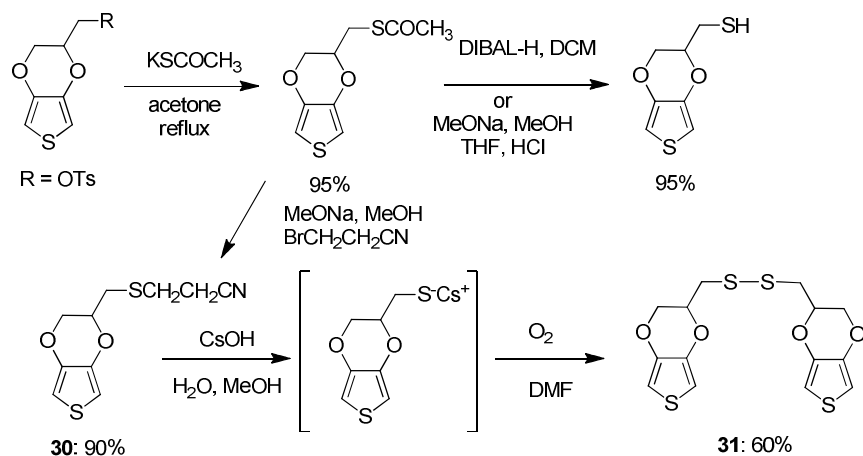

Scheme 14

One of the most useful methods to obtain EDOT derivatives disubstituted in the ethylenedioxy bridge, is the use of transesterification reactions between 3,4-dialkoxythiophenes and 1,2-diols. In this way, enantiomerically pure and chiral derivatives can be prepared in good yields (Scheme 15).²⁶

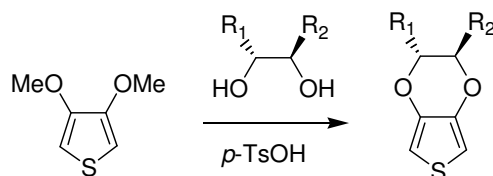

Scheme 15

Mitsunobu reactions have also been used for the synthesis of mono and disubstituted EDOTs from diethyl 3,4-dihydroxy-2,5-thiophenedicarboxylate **2** with good yields (Scheme 16).³ The use of chiral diols afforded chiral EDOT derivatives in high enantiomeric excess. Saponification and further decarboxylation under typical conditions rendered the polymerizable EDOT monomers.

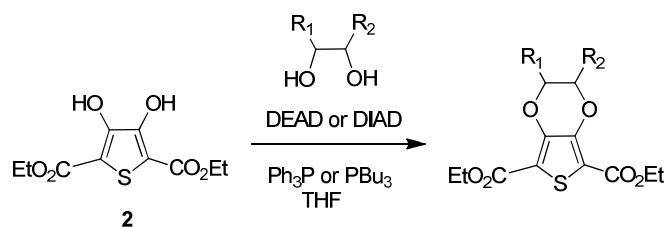

Scheme 16

Palladium-catalyzed cyclization with propargylic carbonates can be an alternative to the synthesis of 3,4-alkylenedioxythiophene (ADOT) derivatives.²⁷ Thus, diol **32** smoothly reacted with propargylic carbonate **33** in the presence of a palladium catalyst to give the cyclized product **34** in 92% yield. Finally, hydrogenation of **34**, in the presence of palladium catalyst, gave *cis*-**35** and *trans*-**35** in 4:1 ratio in quantitative yield (Scheme 17).

The modification of the EDOT structure in which the ethylene bridge is replaced by a 1,2-phenylene moiety rendered the derivative called PheDOT.²⁸ PheDOT and analogous derivatives can be easily obtained in one step by a transesterification reaction between 3,4-dimethoxythiophene and the appropriate catechol, in the presence of a catalytic amount of *p*-toluenesulfonic acid in refluxing toluene. PheDOT is difficult to

electropolymerize; however, in spite of this drawback, it remains an attractive building block for the design and synthesis of soluble π -conjugated systems combining the donor and self structuring properties inherent in the EDOT unit, with possible compact π stacking in the solid state. A PheDOT dimer and a trimer have been synthesized in order to evaluate the potentialities of PheDOT in the design of functional π -conjugated systems (Figure 1).²⁹

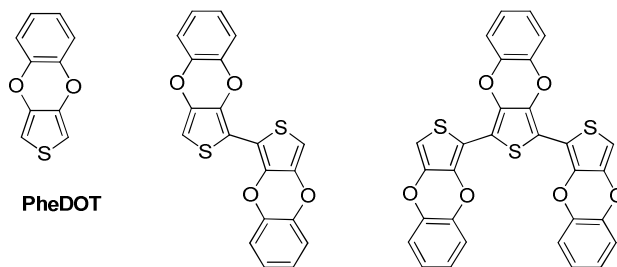
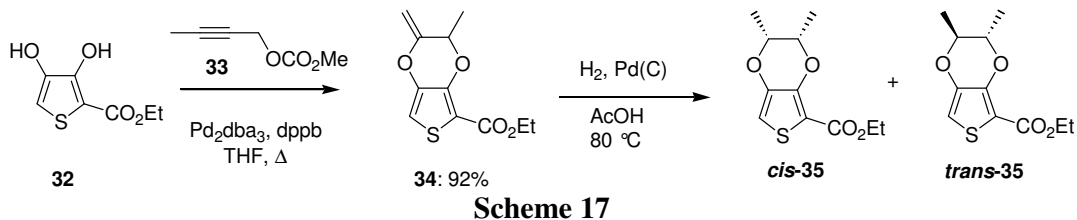

3.2. Basic reactions in the thiophene moiety of EDOT

Basically, the chemistry of EDOT can be referred to thiophene chemistry. Thus, the main transformations in the EDOT structure are based on similar classical reactions known for the thiophene ring. Aldehyde **36**, brominated derivatives **37** and **38** together with stannyl compounds **39** and **40** constitute the basic synthons employed to obtain more sophisticated structures (Figure 2).

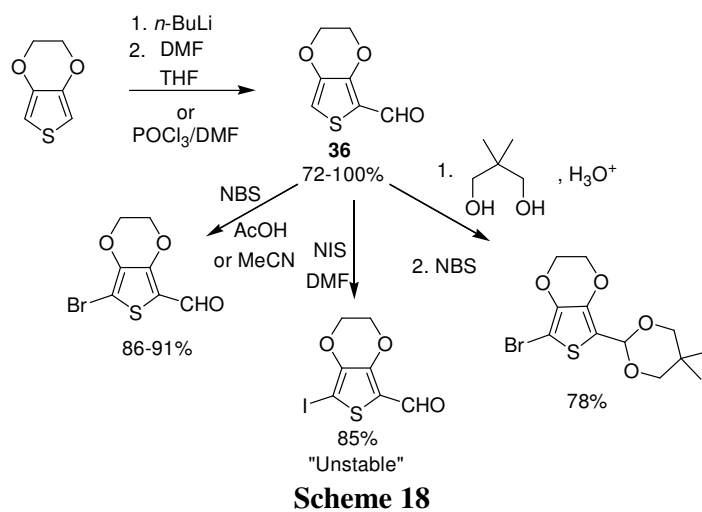
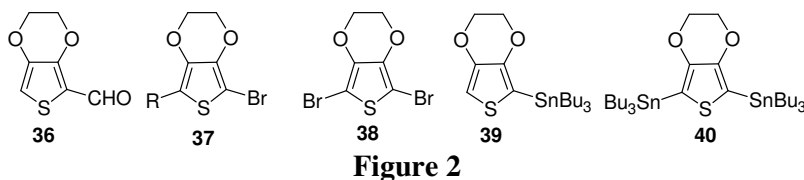

Aldehyde **36** can be obtained in high yield by different approaches: by reaction with *n*-BuLi and DMF at low temperature³⁰ or by Vilsmeier-Haack reaction with POCl₃ and DMF.³¹ Carbaldehyde **36** can be protected with 2,2-dimethyl-propane-1,3-diol in 78% yield and further brominated with NBS in acetonitrile at low temperature to allow additional transformations.³² Iodination and bromination of the deprotected aldehyde have also been reported by the use of NIS³³ and NBS,³⁴ respectively (Scheme 18).

3,4-Ethylenedioxythiophene-2-carbaldehyde **36** is an important synthon for further transformations of the EDOT structure. Main transformations include Wittig-Horner-Emmons (see Section 3.2.2.), Knoevenagel³⁵ or condensation reactions (Scheme 19).³⁶

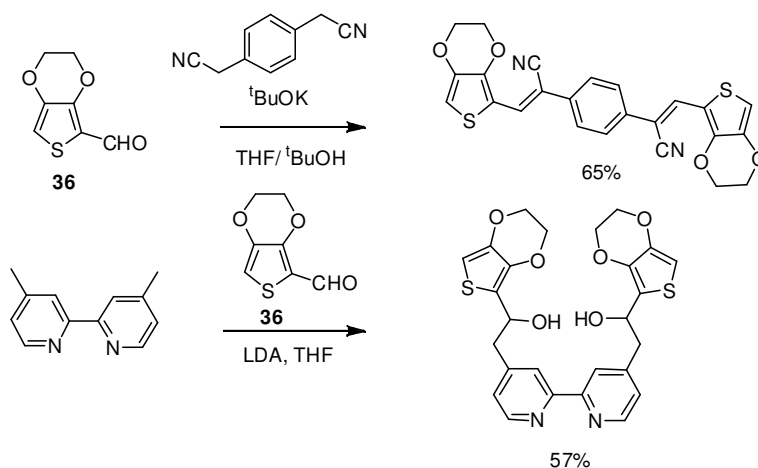

Scheme 19

This type of reactions allows to obtain a variety of simple derivatives and offers an alternative way of designing new materials based on the EDOT moiety. Thus, EDOT-hydrazone prepared from compound **36** have been employed to obtain hole transporting glass-forming organic materials for electrographic photoreceptors.³¹ EDOT-containing azomethine³⁷ is easily prepared as active material with tuneable colours from 2,5-dicarbaldehyde-3,4-ethylenedioxythiophene.³⁸ Fluorescent poly(oxadiazole)s have been obtained from 3,4-ethylenedioxythiophene-2,5-dicarboxylic acid chloride *via* the hydrazide route.³⁹

2,5-Diisocyanato-3,4-ethylenedioxythiophene can be synthesized from diester **3** *via* the hydrazide route (Scheme 20). The azide derivative **41** was used for the *in situ* generation of diisocyanate **42** by heating in dry NMP under an argon atmosphere. In this way, thermoplastic polyureas based on 3,4-ethylenedioxythiophene (EDOT) with flexible aliphatic spacers were synthesized.⁴⁰

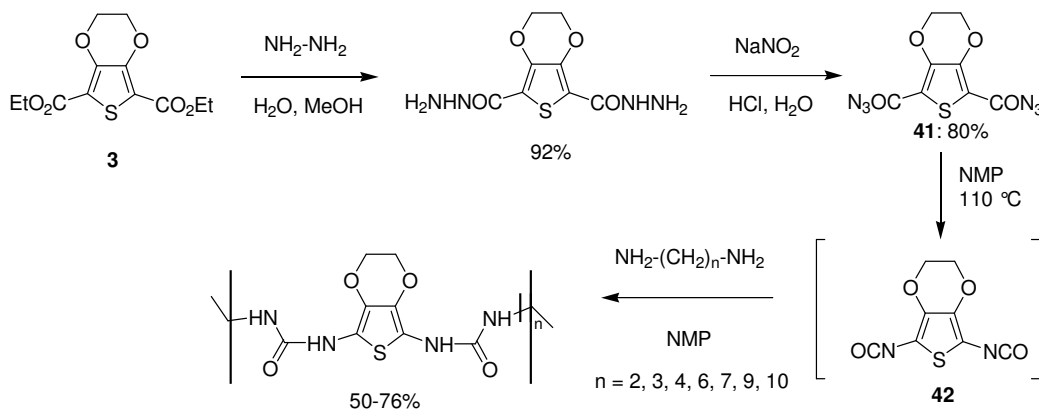

Scheme 20

Different bis-hydrazone, amides and thioamides derived from 3,4-ethylenedioxythiophene have been synthesized as potential anticonvulsants.⁴¹

Bromination of EDOT to get compounds **37** or **38** (Figure 2) is performed preferentially with NBS in CHCl_3 or acetic acid/ CHCl_3 or THF,⁴² although some modifications have also been used.⁴³

2,5-Diiodo-3,4-ethylenedioxythiophene has been synthesized by iodation of the 2,5-dilithium EDOT derivative or by treatment with mercuric acetate/acetic acid followed by iodine addition.⁴² However, better yield (81%) is obtained in the deprotonative dicadmation using CdCl_2 -TMEDA and LiTMP in THF at room temperature followed by the addition of iodine.⁴⁴

Friedel-Craft reactions, followed by a reduction step, allowed the incorporation of alkyl chains.⁴⁵ Other approach for the alkylation of the thiophene moiety involves the reaction of the EDOT lithium derivative with the corresponding haloalkane (Scheme 21).⁴⁶

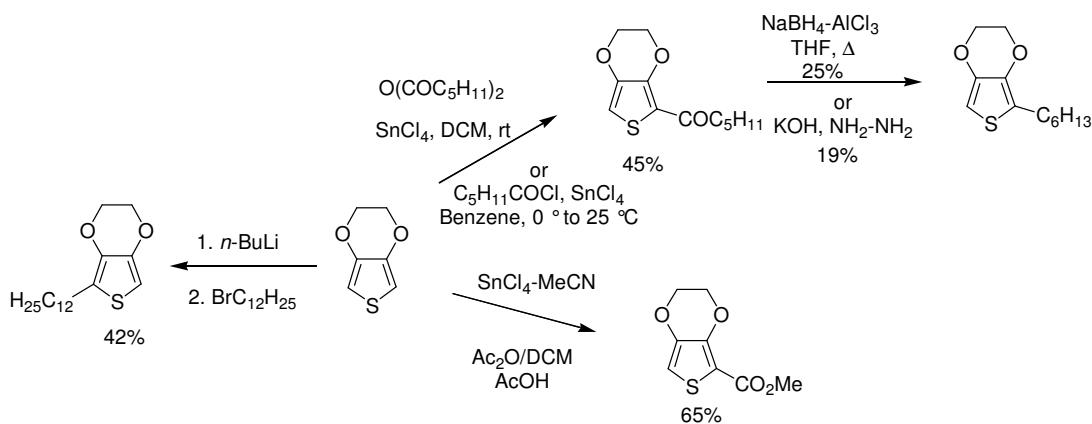

Scheme 21

An example of the utility of the Friedel-Craft reaction as an easy way for the functionalization of EDOT involves the assembly of squaraine **43** to the activated EDOT derivative **44** by treatment with AlCl_3 .⁴⁷

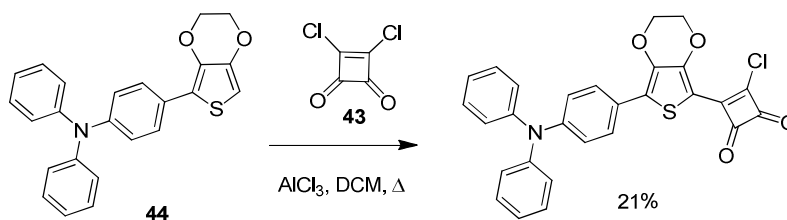

Scheme 22

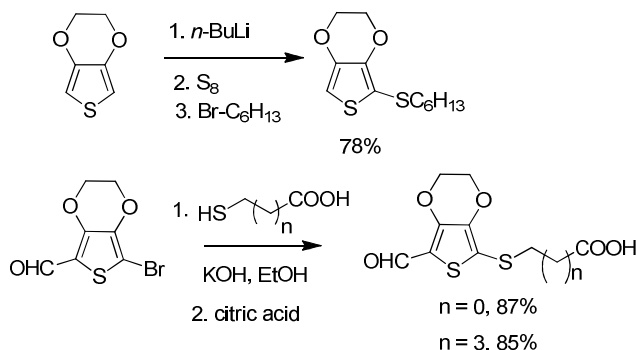

Scheme 23

Sulfanyl chains can be also incorporated *via* the lithium derivative of EDOT by reaction with sulfur powder and the corresponding haloderivative.⁴⁸ Alkyl thioethers can be also attached by means of nucleophilic substitution reactions (Scheme 23).^{33c}

The reaction of lithiated EDOT intermediates with appropriate chlorophosphines provides $\text{Ph}_2\text{P}(\text{EDOT})$, $\text{PhP}(\text{EDOT})_2$ and $\text{P}(\text{EDOT})_3$ which may be used as ligands for coordination chemistry.^{22,49} In addition, 2,5-bis(diphenylphosphino)-3,4-ethylenedioxythiophene ($\text{Ph}_2\text{P-EDOT-PPh}_2$) can be prepared by reaction of chlorodiphenylphosphine with doubly lithiated EDOT. Palladium, platinum and molybdenum complexes were also prepared by reactions of these phosphines with suitable organometallic reagents (Figure 3).

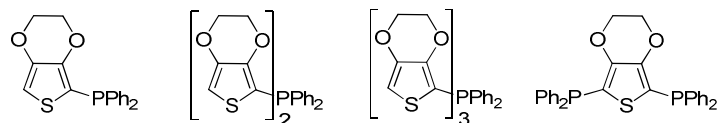
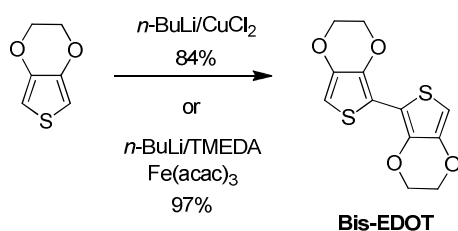

Figure 3

Bis-EDOT can be obtained by oxidative coupling of the lithiated derivative of EDOT in the presence of CuCl_2 ^{25a} (Scheme 24). Alternative methods for the synthesis of Bis-EDOT include the use of TMEDA and $\text{Fe}(\text{acac})_3$ ^{25b} or FeCl_3 with further treatment with hydrazine.⁵⁰



Scheme 24

3.2.1. EDOT-based oligothieryl chalcogenides

Sulfur bridged EDOT oligomers (Figure 4) have been synthesized following two pathways in good yields (57–77%).⁵¹ The first approach involves carbon-sulfur bond formation by treatment of a suitable thienylthiol with a thienyl bromide under basic conditions in the presence of a copper(I) salt.⁵² The second one involves reaction of two equivalents of a Grignard or analogous lithiated thiophene species with bis-(phenylsulfonyl) sulfide (PhSO_2)₂S.⁵³

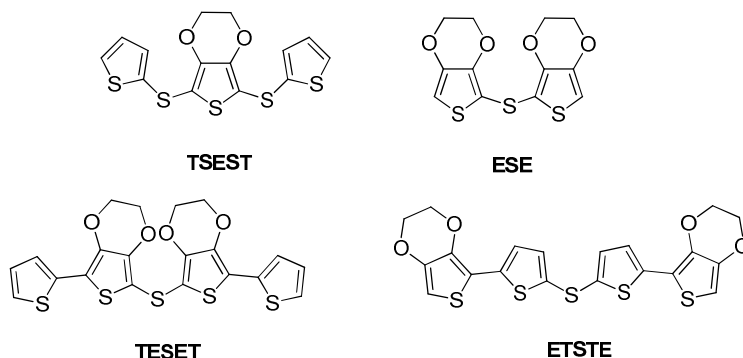
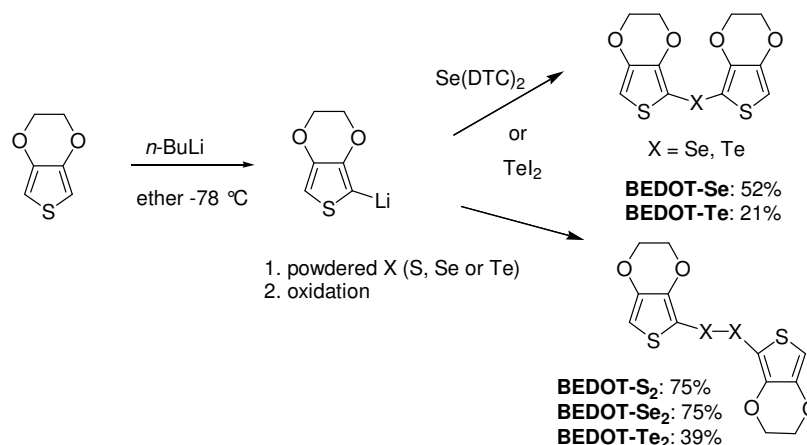

Figure 4

Other oligomers based on 3,4-ethylenedioxythiophene (EDOT) together with mono- and di-chalcogenides in the main chain have been obtained by treatment of EDOT with *n*-butyllithium followed by reaction with Se(DTC)₂ or TeI₂ or finely powdered sulfur, selenium or tellurium, respectively (Scheme 25).⁵⁴



Scheme 25

3.2.2. EDOT derivatives *via* cross-coupling reactions

3.2.2.1. *Via* Stille cross-coupling reaction

Modification of the EDOT structure in positions 2 and 5 is mainly performed by palladium cross-coupling reactions of EDOT stannyl derivatives. EDOT is usually transformed into the corresponding mono- and distannyl derivatives **39** or **40** and subsequently reacted with diverse haloderivatives. This methodology allows to obtain a great variety of structures containing the EDOT moiety.

Thus, a variety of aromatic systems have been coupled to the EDOT unit.⁵⁵ Functionalized anthracene (DTAT),⁵⁶ unsymmetrical dimers containing 3,4-ethylenedisulfanylthiophene (EDST) unit⁵⁷ or pyridyl substituted EDOTs are some examples of compounds conveniently prepared by Stille coupling (Scheme 26).^{58,59} By using this synthetic strategy, EDOT units have been covalently linked to 1,3,5-triarylbenzene as well as to diarylethenes endowed with donor-acceptor groups, in which 3,4-ethylenedioxythiophene was directly connected to BTF (1,2-bis(2-methyl-1-benzo[*b*]thiophen-3-yl)perfluorocyclopentene) to extend π -electron delocalization.⁶⁰

Similarly, pyridine and terpyridine have been coupled with EDOT, using an active, selective and convenient catalytic system, consisting of [Pd(acac)₂] and triphenyl phosphite.⁶¹ Many other nitrogenated heterocycle units have also been linked to EDOT including 1,3,4-thiadiazole,⁶² bithiazole,⁶³ benzothiazole,⁶⁴ benzodithiadiazole,⁶⁵ benzimidazole,⁶⁶ carbazole or indolocarbazolo derivatives.⁶⁷

By using the Stille cross-coupling reaction, EDOT has been incorporated as donor side group in multiple tri-block systems including quinoxalines,^{45a,68} pyridopyrazine,⁶⁹ benzotriazole,⁷⁰ benzo-selenadiazole,⁷¹ thieno[3,2-*b*]thiophene,⁷² 3,4-dialkoxythiophene (ADOT),⁷³ carbazole⁷⁴ or fluorene derivatives.⁷⁵ A novel redox driven chemiluminescent material based on a terthienyl system, namely 5,7-diethylenedioxythiophen-2-yl-2,3-dihydro-thieno[3,4-*d*]-pyridazine-1,4-dione has been designed.⁷⁶ A pyridazine core has been also connected to two EDOT units to create a donor-acceptor-donor type liquid crystal.⁴⁶ EDOT-naphtalene bisimides have been prepared in order to get novel low bandgap conjugated polymers.⁷⁷ Annulated thiopin systems incorporating also side EDOT moieties, which undergo bent-to-planar transformation, driven by aromatization under electrochemical control have been synthesized too.⁷⁸

The EDOT moiety has also been linked to a great variety of triarylamine derivatives for the design of efficient dye-sensitized solar cells.⁷⁹ With the same purpose, EDOT is included in the structure of different ligands of ruthenium complexes, mainly joined pyridines or bis(pyrazoylyl)pyridine derivatives.⁸⁰

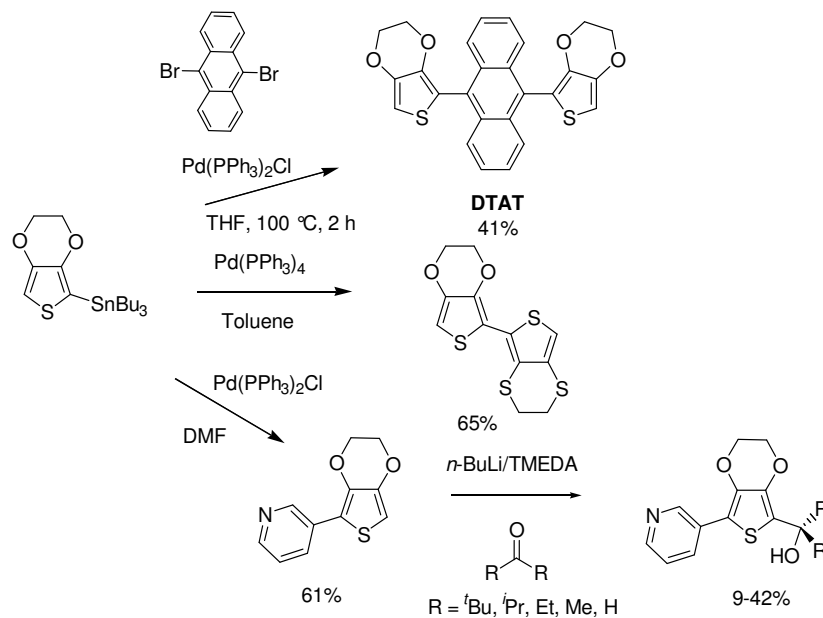

Scheme 26

Different sensors have been obtained incorporating the EDOT unit also by Stille coupling. Some representative examples involve an ambipolar low band gap material based on BODIPY and EDOT,⁸¹ the synthesis of several benzothiadiazoles and dipyrrolyl quinoxalines with extended conjugated chromophores and fluorophores as anion sensors,⁸² bis(pyrazoylyl)pyridine ligands exhibiting efficient lanthanide sensitization⁸³ or the preparation of conjugated polymer sensors of amines built on π -extended boraxilane cages.⁸⁴

Aromatic diamidines with antitumor activity have been connected by 3,4-ethylenedioxythiophene (EDOT).⁸⁵ EDOT has been linked, *via* Stille coupling, to a lot of different thiophene derivatives in the search of new oligomers and polymers with interesting properties.⁸⁶ In this sense, two bithienyl structures, combining EDOT and 3-cyano-4-methoxythiophene building block, have been synthesized, showing that the relative position of the donor acceptor substituents exerts a determining influence on the electronic properties of the bithienyl system and on its aptitude for polymerization.⁸⁷

Another interesting building block for further modification of EDOT by nucleophilic substitution reactions is the bithienyl system **45** which combines an EDOT moiety with a thiophene unit bearing an alkanenitrile chain and which is obtained by Stille coupling. As a representative example **45** has been used for the synthesis of thiol **46** (Scheme 26) which was designed with the aim to associate the ability to form chemisorbed monolayers on gold with the low oxidation potential and high reactivity brought by the EDOT moiety.⁸⁸ Deprotection of the thiolate group of substrate **45**⁸⁹ by cesium hydroxide and subsequent reaction with 1,10-dibromodecane in DMF gave the bromoderivative **47** in 85% yield. Treatment of **47** with potassium thioacetate in refluxing THF led to the formation of thioester **48** in 87% yield. Finally, reduction of **48** with diisobutylaluminum hydride (DIBAL-H) in anhydrous CH_2Cl_2 , followed by addition of hydrochloric acid, led to the target compound **46** in 86% yield.

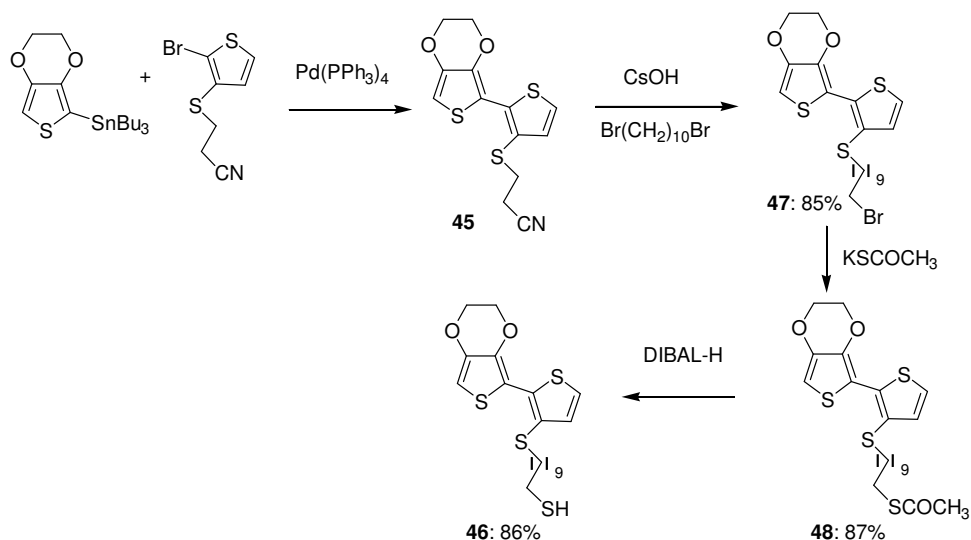

Scheme 27

Bithiophene **45** has revealed as a useful building block and has been used as precursor of a variety of systems consisting of two 3,4-ethylenedioxythiophene containing bithiophenes linked together by octyl, linear polyether and polythioether chains, attached at their internal β -position *via* a sulphide linkage (Figure 5).⁹⁰

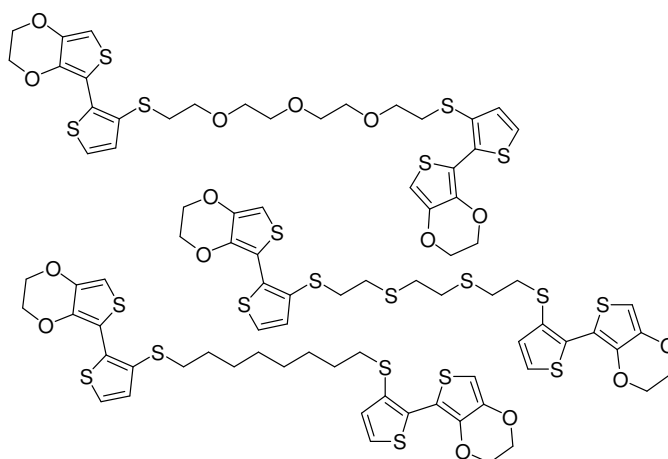
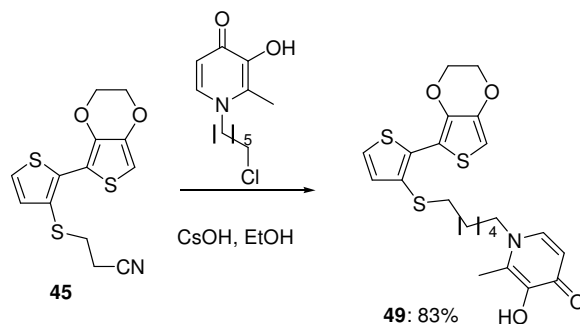

Figure 5

Using a similar strategy, a siderophore-like chelator **49** containing an EDOT unit has been designed (Scheme 28).⁹¹



Scheme 28

The synthesis of trimer **50**, precursor of macrocyclic systems **51**, **52** and **53**, derived from crown-annulated terthiophene, was also carried out by a double Stille coupling reaction between bis(tributylstannyl)-derivative **40** and 2-bromo-3-(2-cyanoethylsulfanyl)thiophene **54**. Further reaction of **50** with the corresponding halogenated compounds afforded the macrocycles **51–53** (Scheme 29).⁹²

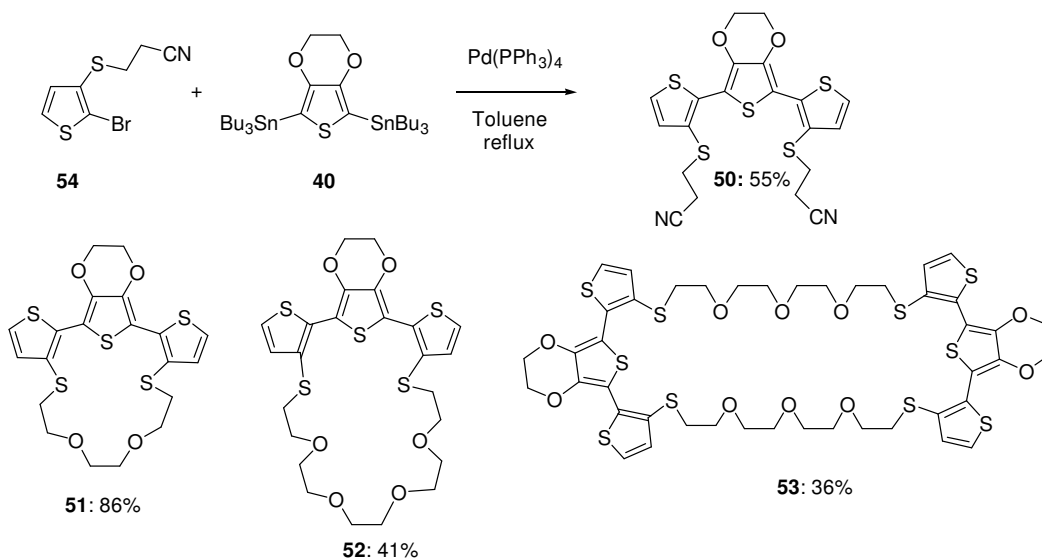

A conjugated oligothiophene **55** functionalized with a Photodynamic azobenzene has been obtained by coupling the stannylated bis-EDOT unit **56** with the bromothiophene derivative **54** (Scheme 30).^{25b} Thus, bis(tributylstannyl) derivative **56** was subjected to a double Stille coupling reaction with 2-bromo-3-(2-cyanoethylsulfanyl)thiophene **54** by using Pd(PPh₃)₄ as the catalyst to give quaterthiophene **57** with two protected thiolate groups in 46% yield. Finally, the target compound **55** was prepared in a one-pot reaction that involves deprotection of the thiolate groups by cesium hydroxide and ring closure by reaction with bis-*p*-bromomethylazobenzene under high dilution conditions.⁹³

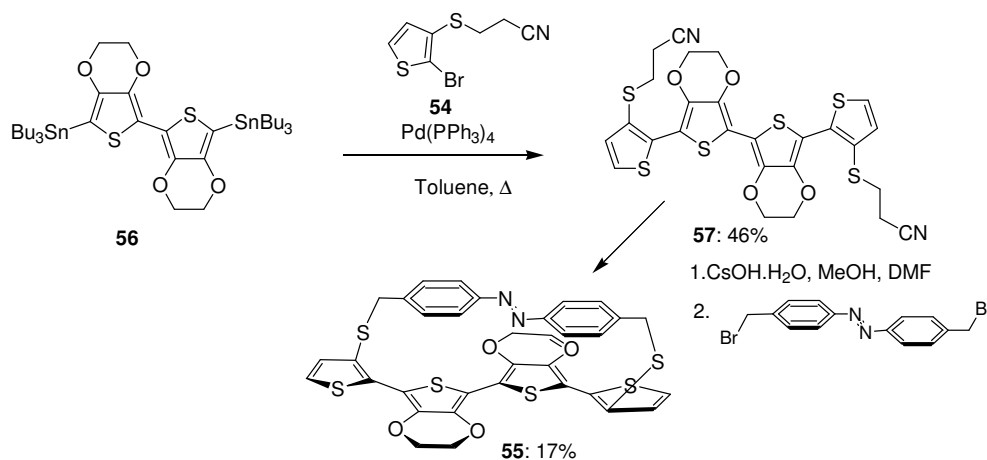

Stille coupling is the key step to construct many other oligothiophene conjugated systems. A plethora of this kind of systems has been described to date, based in the reactions of mono and bisstannyl derivatives of EDOT (Scheme 31).⁹⁴

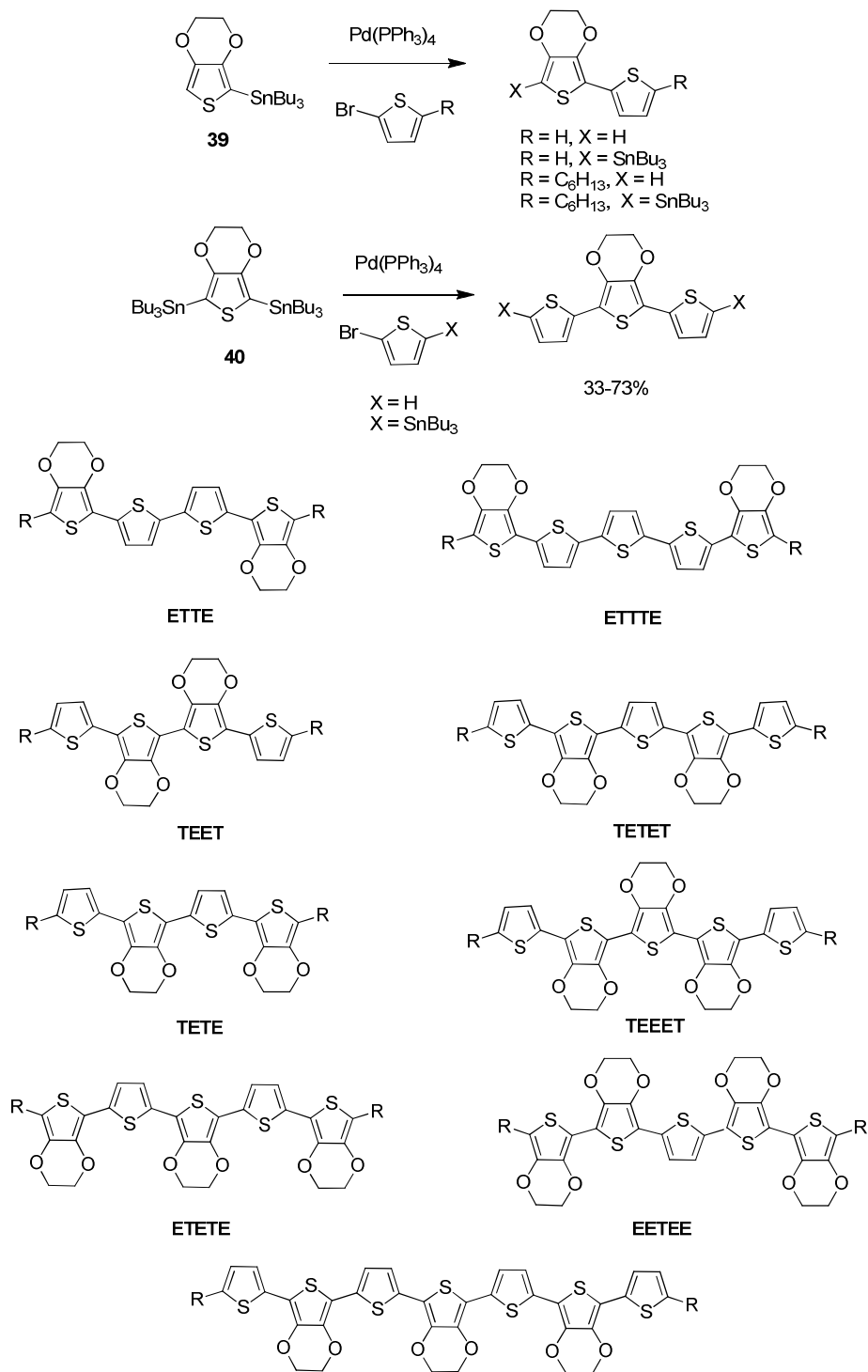

TETETET
Scheme 31

Using this same strategy hybrid π -conjugated oligomers combining EDOT and thiophene-S,S-dioxide units have been obtained providing a nice example of the importance of molecular engineering for band gap tuning in π -conjugated oligomers (Scheme 32).⁹⁵

Rigid oligomers based on the combination of the 3,6-dimethoxythieno[3,2-b]thiophene and 3,4-ethylenedioxythiophene (EDOT) moieties have been also prepared.⁴⁸ The use of the intrinsically rigid thienothiophene units in addition to the characteristic S–O intramolecular interactions in EDOT-based

materials leads to planar conformations of the conjugated chains. While the radical cations of oligomers end capped with *n*-hexyl chains show a tendency to the dimerization, those substituted by *n*-hexylsulfanyl chains present a high stability (Figure 6).

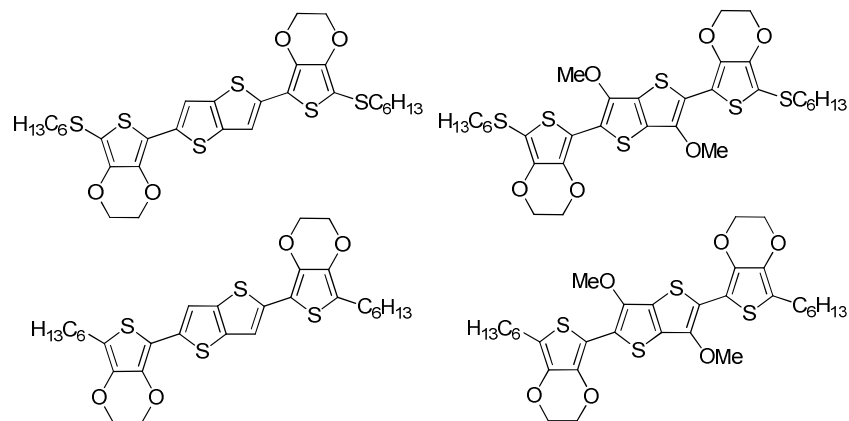
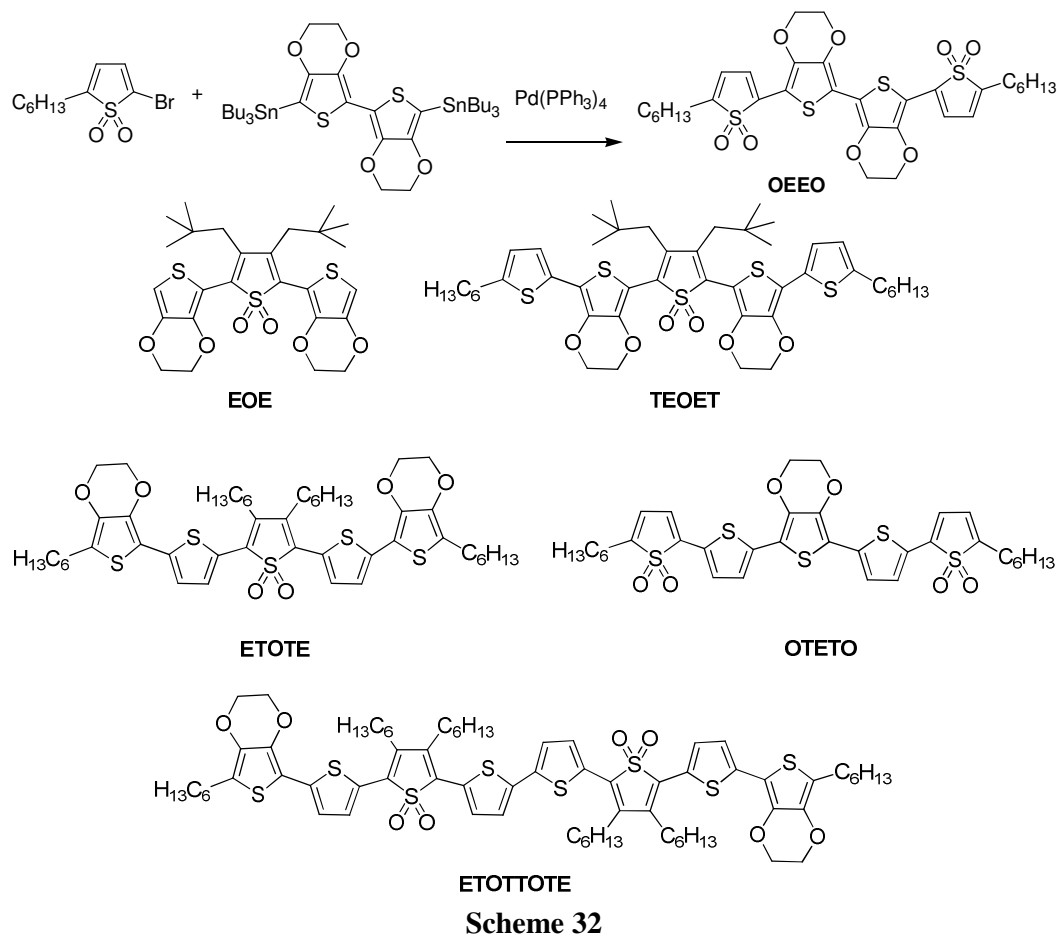

Figure 6

Likewise, hexadecyl functionalized bithiophene and thieno[3,2-b]thiophene systems end-capped with EDOT and EDTT units have been prepared.⁹⁶

Diverse star shaped systems in which the EDOT moiety is present have been designed based in triazine-thiophene conjugated systems⁹⁷ or thiophene oligomers⁹⁸ and donor-acceptor [4]-dendralenes have been prepared as well.⁹⁹

3D-conjugated architectures consisting of short oligothiophene chains, including EDOT units, attached to a connecting node formed by a sterically twisted bithienyl system, have been synthesized by a combination of bromination and organometallic couplings.¹⁰⁰ Other 3D-conjugated systems, based either on oligothiophenes and EDOTs as end-groups or on oligothiophenes incorporating the EDOT moiety and phosphorus nodes, have also been described.¹⁰¹

Some macromolecular interlocked compounds, as rotaxanes, in which the EDOT moiety is conveniently introduced in the precursor compounds by Stille coupling, have also been described in the last years.¹⁰²

Finally, silica nanoparticles have been doped with oligothiophene fluorophores including bis-EDOT blocks by Stille reaction for facile tuning from blue to white emission.¹⁰³

3.2.2.2. Other cross-coupling reactions

An exception to the usual Stille coupling methodology for the synthesis of oligomers containing the EDOT unit is the efficient stepwise route towards elongated EDOT-pyridine alternating oligomers (Scheme 33).^{104a} Deprotonation of EDOT in position 2 using 1/3 equivalent of lithium tributylmagnesate (Bu_3MgLi) in THF at room temperature followed by subsequent cross-coupling of the lithium tri(aryl)magnesate intermediate with 2-bromopyridine afforded the D-A dimeric species **58** in 87% yield, using a combination of PdCl_2 and 1,10-bis(diphenylphosphino)-ferrocene (dppf) ligand (3 mol% each) as the catalyst. Repeating the same procedure starting from heterodimer **58** readily afforded heterotrimer **59** in 73% yield. On the other hand, EDOT was converted to the heterotrimer **61**, by using the modified Negishi cross-coupling protocol, from the corresponding thienylzinc chloride. The thienylzinc chloride derivatized EDOT was obtained from EDOT by deprotonation with butyllithium at 0 °C followed by transmetalation with ZnCl_2 -TMEDA. Subsequent reaction with 2,6-dichloropyridine, catalytic amounts of PdCl_2 and dppf in refluxing THF afforded the monohalogenated derivative **60**, which was isolated in 75% yield. The key building block **60** was then used as the starting material for the synthesis of heterotrimer **61** (73% overall yield).

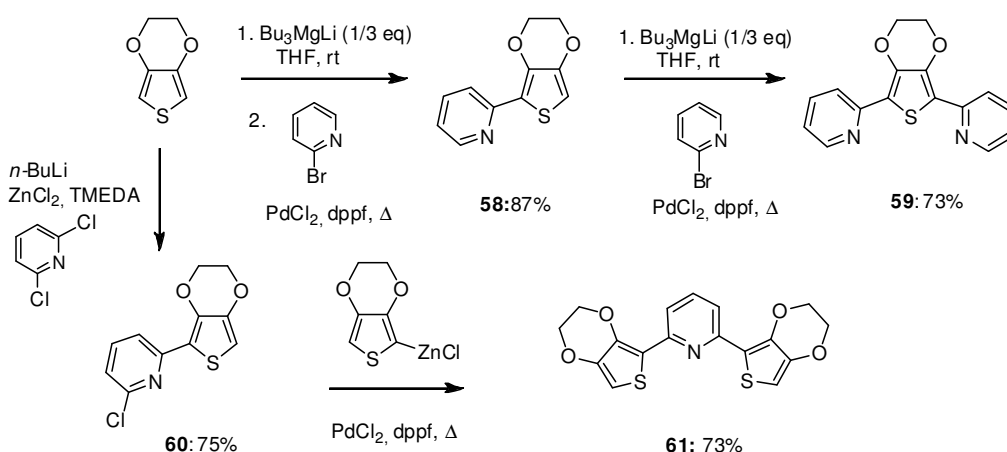

Scheme 33

This strategy can be extended to the preparation of elongated EDOT-pyridine alternating oligomers. This kind of donor-acceptor oligomers has been widely used as building blocks for the synthesis of conjugated copolymers as low band gap organic semiconductor materials.¹⁰⁵ 3,4-Ethylenedioxythiophene has been chosen as the effective donor unit due to its strong electron-donating effects and small steric

interaction between repeating units in polymers.¹⁰⁶ Thus, many electron-acceptor units have been polymerized with EDOT to form low bandgap copolymers¹⁰⁷ which are considered good candidates for polymer solar cell applications.¹⁰⁸

Novel structures based on a series of large, rigid, new, well-defined compounds with three chromophores (truxene moieties at the core, conjugated oligothiophenes including the EDOT moiety as the branch bridges, and [60]pyrrolidinofullerenes in the periphery) have been also synthesized by Negishi reaction.^{104b}

A new class of highly acid-labile backbone amide linkers (BAL handles) based on EDOT, which were termed T-BAL, has been prepared by Negishi cross-coupling reaction from iodo derivative **62** or *via* the already mentioned thioether linkage (Scheme 34).^{33c}

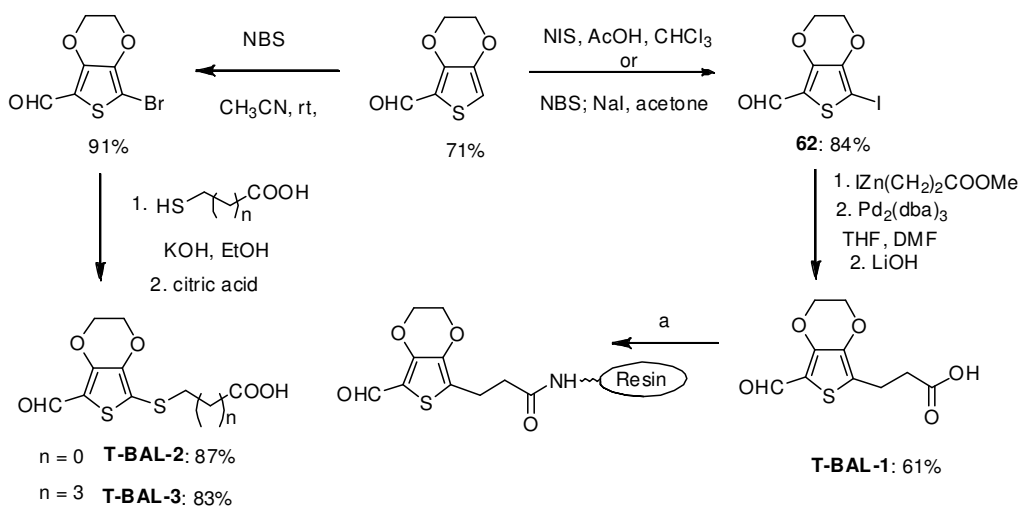

a: HBTU, HOBt, DIPEA, alanine-derivatized polystyrene resin, rt, 2 h, then capping with Ac₂O

Scheme 34

Although it has been used in less extent that Stille coupling, functionalization of position 2 of the thiophene ring in EDOT can also be effective by Suzuki coupling reaction, using EDOT-boronic esters such as **63**, as the coupling agent.¹⁰⁹ As an example, *p*-EDOT-styrene (EDsty) **64** has been prepared from dioxaboronic ester **63**, obtained by treatment of EDOT with *n*-BuLi and further reaction with 2-isopropoxy-4,4,5,5-tetramethyl-1,3,2-dioxaborolane (Scheme 35).

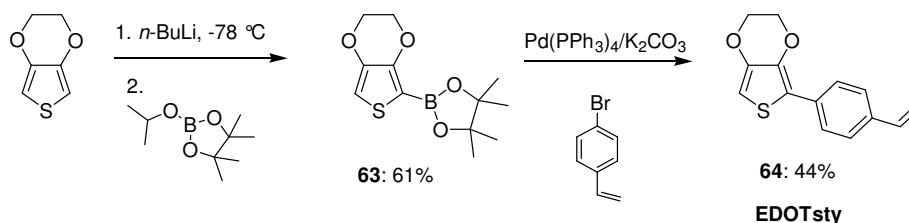

Scheme 35

In addition, Suzuki cross-coupling reactions have been done using bromo- or iodo-EDOT derivatives as the coupling partners with different boronic or substituted boronic acids with good yields and selectivity. Thus, by this strategy phenyl-EDOT derivatives have been prepared as super acid labile carboxylic acid protecting groups for peptide synthesis.^{33b} Similarly, the 5-(4-hydroxyphenyl)-3,4-ethylenedioxythienyl

alcohol (THAL, Thiophene Acid Labile) has been described as a new linker for the solid-phase synthesis of peptide carboxylic acids (Figure 7).^{33a} Other examples can be found in the synthesis of efficient dye-sensitized solar cells using triphenylamines (TPA) linked to 3,4-ethylenedioxythiophene.¹¹⁰ Examples of double Suzuki coupling with 2,5-dibromoethylenedioxythiophene **38** (Figure 2) can be found in the design of oligothiophenes linked to melamine-barbituric acid system as motifs for hydrogen bonding.¹¹¹

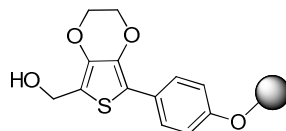
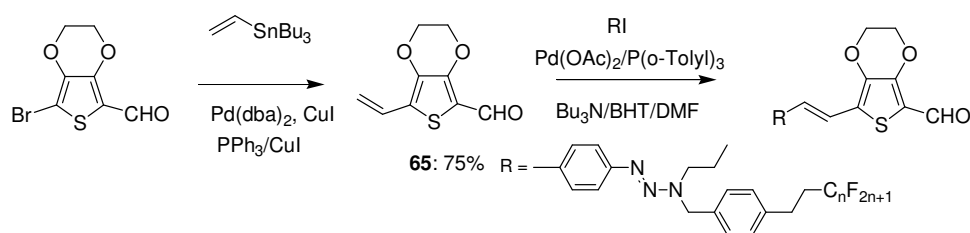

Figure 7

Heck reaction has been applied for the synthesis of diazonium-functionalized oligo(phenylene vinylene)s *via* the vinyl derivative **65**, obtained previously by Stille reaction (Scheme 36).³⁴



Scheme 36

Alternatively, the direct regioselective C–H arylation of 3,4-ethylenedioxythiophene (EDOT) can be performed successfully under ‘Heck-type’ experimental conditions yielding mono or bis-aryl derivatives in moderate yield. This novel synthetic methodology has been used to prepare in a more simple way a series of oligothiophenes interesting as organic electronic materials (Scheme 37).¹¹²

Sonogashira cross-coupling reaction have been utilized in the synthesis of diverse systems incorporating alkyne moieties attached to the EDOT unit. Thus, tetrathiafulvalene has been successfully joined to an EDOT moiety using Sonogashira coupling as key step, thus allowing the use of π -extended tetrathiafulvalene derivatives in dye-sensitized solar cells.¹¹³

Platinum(II) polyynes (Pt₂BTD-EDOT) **66** functionalized with 3,4-ethylenedioxythiophene-benzothiadiazole hybrid spacers are another class of compounds obtained by Sonogashira reaction in the presence of platinum complex **67** (Scheme 38).¹¹⁴

Similarly, other platinum acetylide oligomers have been prepared including EDOT and diphenylamino-2,7-fluorenylene units.¹¹⁵

Recently, a direct alkynylation of thiophenes, including EDOT, has been described by cooperative activation with TIPS-EBX (1-[(triisopropylsilyl)ethynyl]-1,2-benziodoxol-3(1*H*)-one), gold and Brønsted acids.¹¹⁶

Metal free cross-coupling reactions to obtain aromatic functionalized EDOT derivatives can be performed using PhI(OH)OTs in fluoroalcohol media in the presence of TMSBr under mild conditions.¹¹⁷

Finally, decarboxylative cross-coupling *via* palladium catalyst has allowed to incorporate EDOT in a 3,4-proylenedioxy pyrrole based conjugated oligomers with moderate yields.¹¹⁸

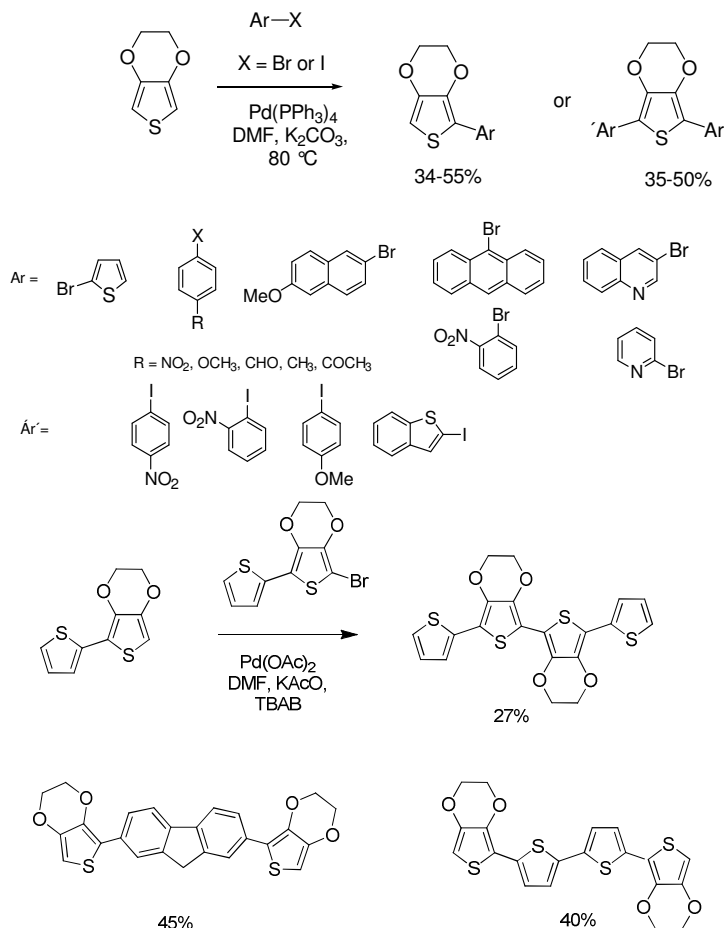

Scheme 37

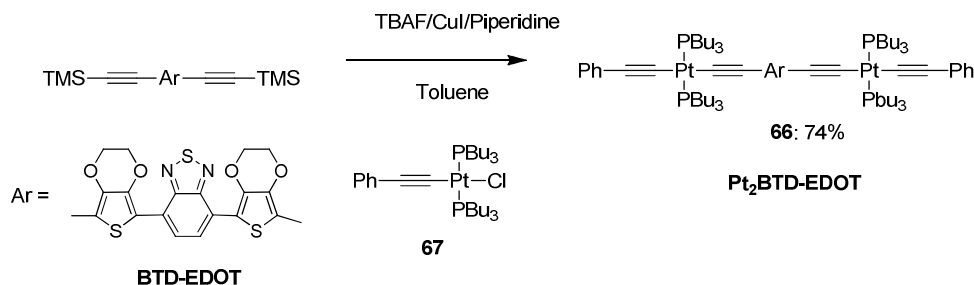

Scheme 38

3.2.2. EDOT derivatives *via* Wittig-Horner-Emmons reactions

The use of Wittig-Horner reactions provides a straightforward procedure toward functionalized EDOTs. Cava and co-workers described the synthesis of a triphenylphosphonium salt bearing the EDOT moiety,¹¹⁹ but the Wittig reactions involving the corresponding ylide led to very low yields of the expected olefins (less than 5%). Roncali *et al.*³⁸ developed the synthesis of EDOT derivatives **68** and **69** containing methylphosphonate groups which gave more reacting phosphonate anions (Scheme 39). Compounds **68** and **69** were obtained in 56 and 31% yields, respectively, in a one-step reaction from EDOT or *n*-hexyl-EDOT by successive addition of *n*-BuLi, CuI and diethyl-iodomethylphosphonate. The formation of the intermediate 2-thienyl copper reactants decreases the basic character of the organometallic compound thus favouring the nucleophilic substitution with the iodinated phosphonate by avoiding the acid-base reaction. Twofold Wittig-Horner olefination between phosphonates **68** and **69** and diverse diformyl derivatives in the

presence of *t*-BuOK at room temperature gave a series of thienylenevinylene based oligomers in 50–65% yields.

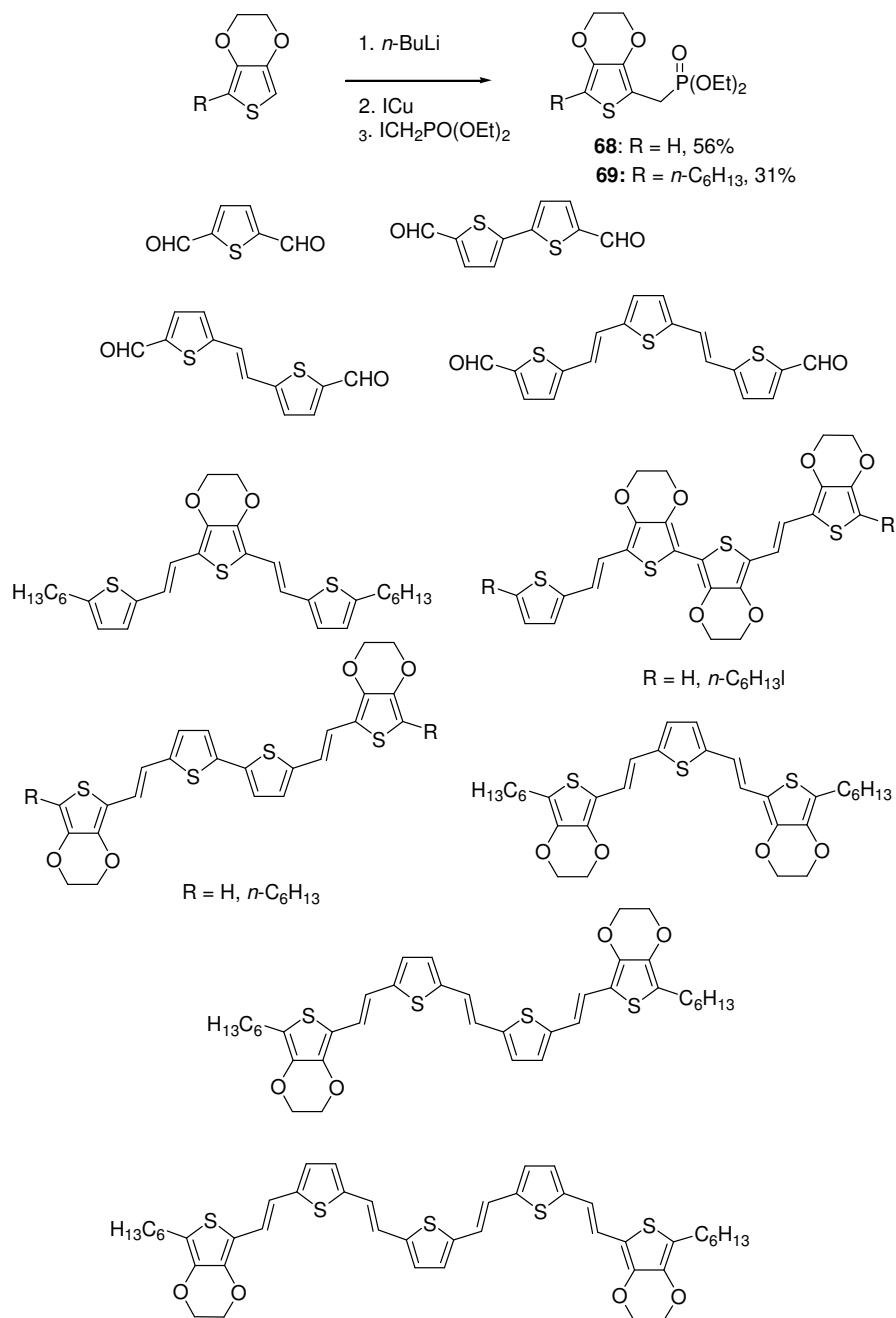

Scheme 39

More recently phosphonate-functionalized EDOT **68** has been obtained from alcohol **70** by Lewis acid-mediated Michaelis-Arbuzov reaction at room temperature (Scheme 40).¹²⁰

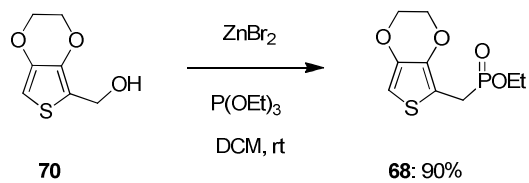

Scheme 40

Bis-phosphonate **71** based on the bis-EDOT moiety has also been obtained by following the synthetic procedure depicted in Scheme 41. Mannich reaction between bis-EDOT and dimethyliminium cation **72** yielded the bis-amino derivative **73** which, after treatment with a slight excess of methyl iodide, led to compound **74** in a 64% overall yield. Finally, reaction of diethyl phosphate with the diammonium salt **74** gave bis-phosphonate **71**.³⁸

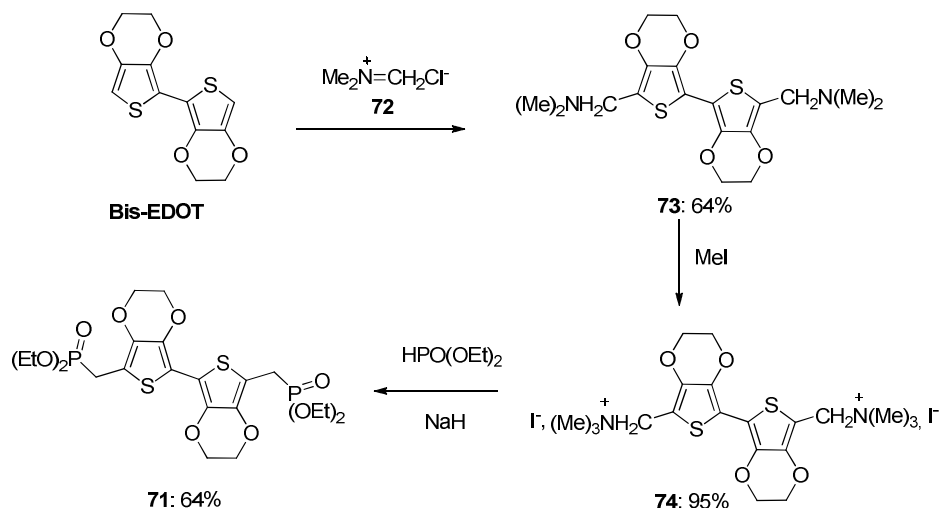

Wittig-Horner reactions are also the key step for the synthesis of donor-(π -spacer)-acceptor dyes, designed for dye-sensitized solar cells (DSSCs) (Scheme 42).¹¹⁷ These dyes possess the same donor (triarylamine) and acceptor/anchoring groups (2-cyanoacrylic acid), but different π -spacers consisting of a combination of thiophene and/or 3,4-ethylenedioxythiophene (EDOT) units. Synthetic routes to this type of organic dyes are illustrated in Scheme 42.

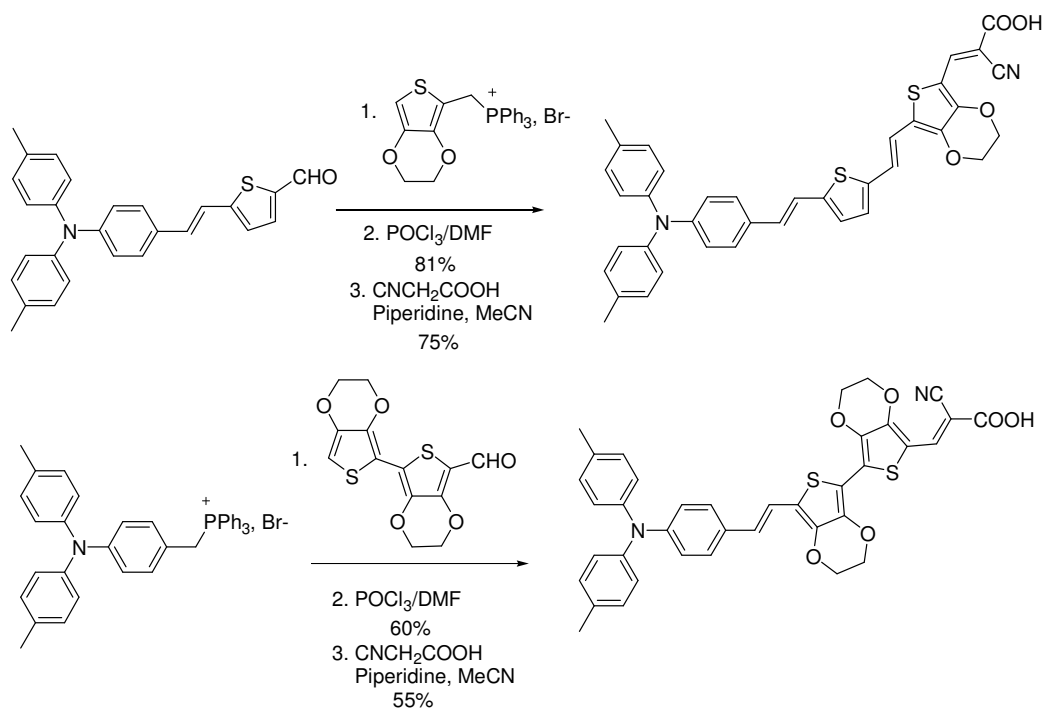

Thus, the target dyes were yielded by Knoevenagel reaction of the corresponding aldehydes, obtained by Vilsmeier-Haack reaction, with cyanoacetic acid in refluxing acetonitrile in the presence of piperidine.

EDOT derivatives **75** were prepared as monomers for the synthesis of pyridine-EDOT heteroarylene-vinylene donor-acceptor copolymers by means of electropolymerization or Yamamoto reaction.¹²² The synthesis of these derivatives was done through a one-pot double Horner-Emmons condensation of tetraethyl bis(methanephosphonate)pyridines **76** with two equivalents of 3,4-ethylenedioxythiophene-2-carbaldehyde **36** using potassium *tert*-butoxide as the base (Scheme 43).

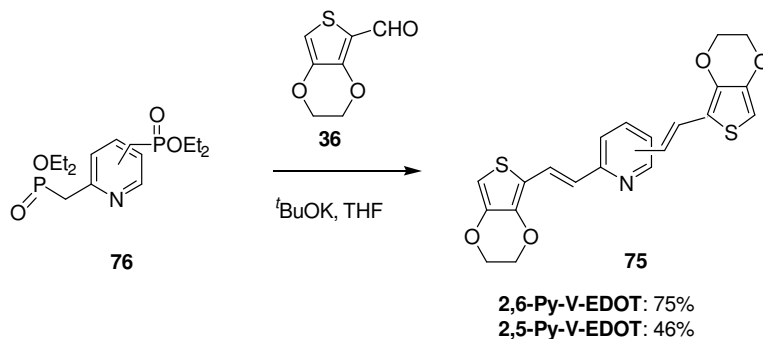

Scheme 43

A similar strategy has been used in the synthesis of a metal-free organic dye consisting of a phenothiazine donor, a 3,4-ethylenedioxythiophene bridge and a cyanoacrylate acceptor.¹²³

4. Conclusions

In spite of the several review articles devoted to the outstanding properties and applications of poly(3,4-ethylenedioxythiophene) (PEDOT),¹ until now there was a lack of a comprehensive review on the synthetic methodologies for the preparation of EDOT and its derivatives. The aim of the present review has been to summarize the main synthetic procedures for obtaining EDOT itself and to illustrate the fact that functionalized EDOTs are efficient intermediates for the preparation of compounds with interest in a variety of different fields ranging from dye sensitized solar cells,^{79,80,110,113,121} sensors,^{81–84} antitumor activity,⁸⁵ siderophore like chelators⁹¹ or low band gap materials for organic photovoltaics.^{77,107}

Acknowledgments

The authors would like to thank to MICINN (CTQ2010-14982), Comunidad Autónoma de Madrid (S2009/MAT-1467) and the UCM-BSCH joint project (GR35/10-A-910759) for financial support. A. de la Peña acknowledges the Universidad Complutense for a predoctoral grant.

References

- Groenendaal, L.; Jonas, F.; Freitag, D.; Pielartzick, H.; Reynolds, J. R. *Adv. Mater.* **2000**, *12*, 481.
 - Groenendaal, L.; Zotti, G.; Aubert, P. H.; Waybright, S. M.; Reynolds, J. R. *Adv. Mater.* **2003**, *15*, 855.
 - Roncali, J.; Blanchard, P.; Frère, P. *J. Mater. Chem.* **2005**, *15*, 1589.
 - Kirchmeyer, S.; Reuter, K. *J. Mater. Chem.* **2005**, *15*, 2077.
 - Handbook of Conducting Polymers, 3rd Ed.*; Skotheim, T. A.; Reynolds, J. R., Eds.; Taylor and Francis: Boca Raton, FL; 2007, Vols. 10 and 13.
- Raimundo, J. M.; Blanchard, P.; Brisset, H.; Akoudad, S.; Roncali, J. *Chem. Commun.* **2000**, 939.
- Raimundo, J. M.; Blanchard, P.; Frère, P.; Mercier, N.; Ledoux Rak, I.; Hierle, R.; Roncali, J. *Tetrahedron Lett.* **2001**, *42*, 1507.
 - Raimundo, J. M.; Blanchard, P.; Gallego Planas, N.; Mercier, N.; Ledoux Rak, I.; Hierle, R. *J. Org. Chem.* **2002**, *67*, 205.

4. (a) Akoudad, S.; Frère, P.; Mercier, N.; Roncali, J. *J. Org. Chem.* **1999**, *64*, 4267. (b) Leriche, P.; Turbiez, M.; Monroche, V.; Frère, P.; Blanchard, P.; Skabara, P. J.; Roncali, J. *Tetrahedron Lett.* **2003**, *44*, 649.
5. (a) Mohanakrishnan, A. K.; Hucke, A.; Lyon, M. A.; Lakshmikantham, M. V.; Cava, M. P. *Tetrahedron* **1999**, *55*, 11745. (b) Turbiez, M.; Frère, P.; Blanchard, P.; Roncali, J. *Tetrahedron Lett.* **2000**, *41*, 5521. (c) Hicks, R. G.; Nodwell, M. B. *J. Am. Chem. Soc.* **2000**, *122*, 6746. (d) Apperloo, J. J.; Groenendaal, L.; Verheyen, H.; Jayakannan, M.; Janssen, R. A. J.; Dkhissi, A.; Beljonne, D.; Lazzaroni, R.; Bredas, J. L. *Chem. Eur. J.* **2002**, *8*, 2384. (e) Turbiez, M.; Frère, P.; Roncali, J. *J. Org. Chem.* **2003**, *68*, 5357.
6. Pei, Q.; Zuccarello, G.; Ahlskog, M.; Inganäs, O. *Polymer* **1994**, *35*, 1347.
7. (a) Zong, K.; Madrigal, L.; Groenendaal, L. B.; Reynolds, J. R. *Chem. Commun.* **2002**, 2498. (b) Caras-Quintero, D.; Bäuerle, P. *Chem. Commun.* **2002**, 2690. (c) Spencer, H. J.; Skabara, P. J.; Giles, M.; McCulloch, I.; Coles, S. J.; Hursthouse, M. B. *J. Mater. Chem.* **2005**, *15*, 4783.
8. Von Kieseritzky, F.; Allared, F.; Dahlstedt, E.; Helberg, J. *Tetrahedron Lett.* **2004**, *45*, 6049.
9. Hachiya, I.; Matsumoto, T.; Inagaki, T.; Takahashi, A.; Shimizu, M. *Heterocycles* **2010**, *82*, 449.
10. Das, S.; Dutta, P. K.; Panda, S.; Zade, S. S. *J. Org. Chem.* **2010**, *75*, 4868.
11. (a) Lima, A.; Schottland, P.; Sadki, S.; Chevrot, C. *Synth. Met.* **1998**, *93*, 33. (b) Akoudad S.; Roncali J. *Electrochem. Commun.* **2000**, *2*, 72. (c) Kim, J. K.; Park, J. H.; Lee, S-H.; Lee, Y. *Sol. Energy Mat. Sol. Cells* **2009**, *93*, 1398. (d) Hsiao, A.-E.; Tuan, C.-S.; Lu, L.-H.; Liao, W.-S.; Teng, W.-J. *Synth. Met.* **2010**, *160*, 2319.
12. (a) Schwendeman, I.; Gaupp, C. L.; Hancock, J. M.; Groenendaal, L. B.; Reynolds, J. R. *Adv. Funct. Mater.* **2003**, *13*, 541. (b) Brisset, H.; Navarro, A. E.; Moustrou, C.; Perepichka, I. F.; Roncali, J. *Electrochem. Commun.* **2004**, *6*, 249.
13. (a) Besbes, M.; Trippe, G.; Levillain, E.; Mazari, M.; Le Derf, F.; Perepichka, I.; Dourdour, A.; Gorgues, A.; Sallé, M.; Roncali, J. *Adv. Mater.* **2001**, *13*, 1249. (b) Trippe, G.; Le Derf, F.; Lyskawa, J.; Mazari, M.; Roncali, J.; Gorgues, A.; Levillain, E.; Sallé, M. *Chem. Eur. J.* **2004**, *10*, 6497. (c) Cutler, C.; Bouguettaya, M.; Kang, T.-S.; Reynolds, J. R. *Macromolecules* **2005**, *38*, 3068. (d) Moskwa, T.; Domagala, W.; Czardybon, A.; Pilawa, B.; Lapkowski, M. *Synth. Met.* **2005**, *152*, 189. (e) Navarro, A.-E.; Fages, F.; Moustrou, C.; Brisset, H.; Spinelli, N.; Chaix, C.; Mandrand, B. *Tetrahedron* **2005**, *61*, 3497. (f) Benedetto, A.; Balog, M.; Rayah, H.; Le derf, F.; Viel, P.; Palacin, S.; Sallé, M. *Electrochim. Acta* **2008**, *53*, 3779. (g) Su, W.; Nguyen, H. T.; Cho, M.; Son, Y.; Lee, Y. *Synth. Met.* **2010**, *160*, 2471. (h) Ali, E. M.; Kantchev, E. A. B.; Yu, H.; Ying, J. Y. *Macromolecules* **2007**, *40*, 6025. (i) Tang, H.; Chen, L.; Xing, C.; Guo, Y.-G.; Wang, S. *Macromol. Rapid. Commun.* **2010**, *31*, 1892. (j) Tansil, N. C.; Assen, E.; Gaoa, Z.; Yu, H.-H. *Chem. Commun.* **2011**, *47*, 1533.
14. (a) For Biotin functionalized EDOT, see: Mouffouk, F.; Higgins, S. J. *Electrochem. Commun.* **2006**, *8*, 15. (b) For oliogonucleotide functionalized EDOT, see: Moffouk, F.; Higgins, S. J. *Electrochem. Commun.* **2006**, *8*, 317, and reference 13e.
15. Skompska, M.; Vorotyntsev, M. A.; Refczynska, M.; Goux, J.; Leniewska, E.; Boni, G.; Moise, C. *Electrochim. Acta* **2006**, *51*, 2108.
16. Velauthamurthy, K.; Higgins, S. J.; Gamini Rajapakse, R. M.; Bandara, H. M. N.; Shimomura, M. *Electrochim. Acta* **2010**, *56*, 326.
17. (a) Segura, J. L.; Gómez, R.; Blanco, R.; Reinold, E.; Bäuerle, P. *Chem. Mater.* **2006**, *18*, 2834. (b) Segura, J. L.; Gómez, R.; Reinold, E.; Bäuerle, P. *Org. Lett.* **2005**, *7*, 2345. (c) Daugaard, A. E.; Hvilsted, S.; Hansen, T. S.; Larsen, N. B. *Macromolecules* **2008**, *41*, 4321.
18. Arias-Pardilla, J.; Otero, T. F.; Blanco, R.; Segura, J. L. *Electrochim. Acta* **2010**, *55*, 1535.
19. (a) Bu, H. B.; Götz, G.; Reinold, E.; Vogt, A.; Schmid, S.; Blanco, R.; Segura, J. L.; Bäuerle, P. *Chem. Commun.* **2008**, 1320. (b) Bu, H.-B.; Götz, G.; Reinold, E.; Vogt, A.; Schmid, S.; Segura, J. L.; Blanco, R.; Gómez, R.; Bäuerle, P. *Tetrahedron* **2011**, *67*, 1114. (c) Bu, H.-B.; Götz, G.; Reinold, E.; Vogt, A.; Azumi, R.; Segura, J.L.; Bäuerle, P. *Chem. Commun.* **2012**, *48*, 2677.
20. Blanco Bazaco, R.; Gómez, R.; Seoane, C.; Bäuerle, P.; Segura, J. L. *Tetrahedron Lett.* **2009**, *50*, 4154.
21. Döbbelin, M.; Pozo-Gonzalo, C.; Marcilla, R.; Blanco, R.; Segura, J. L.; Pomposo, J. A.; Mercerreyes, D. *J. Polym. Sci., Part A* **2009**, *47*, 3010.

22. Velauthamurthy, K.; Higgins, S. J.; Gamini Rajapakse, R. M.; Bacsá, J.; van Zalinge, H.; Nicholá, R. J.; Haiss, W. *J. Mater. Chem.* **2009**, *19*, 1850.
23. Balog, M.; Rayah, H.; Le Derf, F.; Salle, M. *New J. Chem.* **2008**, *32*, 1183.
24. (a) Svenstrup, N.; Rasmussen, K. M.; Hansen, T. K.; Becher, J. *Synthesis* **1994**, 809. (b) Nielsen, M. B.; Lomholt, C.; Becher, J. *Chem. Soc. Rev.* **2000**, *29*, 153.
25. (a) Blanchard, P.; Jousselme, B.; Frère, P.; Roncali, J. *J. Org. Chem.* **2002**, *67*, 3961. (b) Jousselme, B.; Blanchard, P.; Allain, M.; Levillain, E.; Dias, M.; Roncali, J. *J. Phys. Chem. A* **2006**, *110*, 3488.
26. Caras-Quintero, D.; Bäüerle, P. *Chem. Commun.* **2004**, 926.
27. Zong, K. *Bull. Korean Chem. Soc.* **2009**, *30*, 1207.
28. Roquet, S.; Leriche, P.; Perepichka, I. F.; Jousselme, B.; Frère, P.; Roncali, J. *J. Mater. Chem.* **2004**, *14*, 1396.
29. Perepichka, I. F.; Roquet, S.; Leriche, P.; Raimundo, J.-M.; Frère, P.; Roncali, J. *Chem. Eur. J.* **2006**, *12*, 2960.
30. Selected examples can be found in: (a) Isidro-Llobet, A.; Just-Baringo, X.; Álvarez, M.; Albericio, F. *Biopolymers* **2008**, *90*, 444. (b) Mumtaz, M.; de Cuendías, A.; Putaux, J.-L.; Cloutet, E.; Cramail, H. *Macromol. Rapid. Commun.* **2006**, *27*, 1446.
31. A selected example can be found in: Lygaitis, R.; Grazulevicius, J. V.; Tran Van, F.; Chevrot, C.; Jankauskas, V.; Jankunaite, D. *J. Photochem. Photobiol. A-Chem.* **2006**, *181*, 67.
32. Firstenberg, M.; Shivananda, K. N.; Cohen, I.; Solomeshch, O.; Medvedev, V.; Tessler, N.; Eichen, Y. *Adv. Funct. Mater.* **2011**, *21*, 634.
33. (a) Isidro-Llobet, A.; Boas, U.; Jensen, K. J.; Álvarez, M.; Albericio, F. *J. Org. Chem.* **2008**, *73*, 7342. (b) Isidro-Llobet, A.; Álvarez, M.; Albericio, F. *Tetrahedron Lett.* **2008**, *49*, 3304. (c) Jessing, M.; Brandt, M.; Jensen, K. J.; Christensen, J. B.; Boas, U. *J. Org. Chem.* **2006**, *71*, 6734.
34. Jian, H.; Tour, J. M. *J. Org. Chem.* **2005**, *70*, 3396.
35. Thompson, B. C.; Kim, Y.-G.; McCarley, T. D.; Reynolds, J. R. *J. Am. Chem. Soc.* **2006**, *128*, 12714.
36. (a) Abbotto, A.; Bellotto, L.; De Angelis, F.; Manfredi, N.; Marinzi, C. *Eur. J. Org. Chem.* **2008**, 5047. (b) Abbotto, A.; Barolo, C.; Bellotto, L.; De Angelis, F.; Grätzel, M.; Manfredi, N.; Marinzi, C.; Fantacci, S.; Yumd, J.-H.; Nazeeruddin, M. K. *Chem. Commun.* **2008**, 5318. (c) Abbotto, A.; Sauvage, F.; Barolo, C.; De Angelis, F.; Fantacci, S.; Graetzel, M.; Manfredi, N.; Marinzi, C.; Nazeeruddin, M. K. *Dalton Trans.* **2011**, *40*, 234.
37. Bolduc, A.; Dufresne, S.; Skene, W. G. *J. Mat. Chem.* **2010**, *20*, 4820.
38. Turbiez, M.; Frère, P.; Roncali, J. *Tetrahedron* **2005**, *61*, 3045.
39. Udayakumar, D.; Vasudeva Adhikari, A. *Opt. Mater.* **2007**, *29*, 1710.
40. Ojha, U. P.; Ramesh, C.; Kumar, A. *J. Polym. Sci., Part A* **2005**, *43*, 5823.
41. (a) Kulandasamy, R.; Adhikari, A. V.; Stables, J. P. *Eur. J. Med. Chem.* **2009**, *44*, 4376. (b) Kulandasamy, R.; Adhikari, A. V.; Stables, J. P. *Bull. Korean Chem. Soc.* **2010**, *31*, 3318.
42. Meng, H.; Perepichka, D. F.; Bendikov, M.; Wudl, F.; Pan, G. Z.; Yu, W. J.; Dong, W. J.; Brown, S. J. *Am. Chem. Soc.* **2003**, *125*, 15151.
43. Gao, D.; Kohler, B.; Scherf, U. *J. Phys. Chem. B.* **2006**, *110*, 24346.
44. L'Helgoual'Ch, J. M.; Bentabed-Ababsa, G.; Chevallier, F.; Yonehara, M.; Uchiyama, M.; Derdourb, A.; Mongin, F. *Chem. Commun.* **2008**, 5375.
45. (a) Casado, J.; Ponce Ortíz, R.; Ruíz Delgado, M. C.; Hernández, V.; López Navarrete, J. T.; Raimundo, J.-M.; Blanchard, P.; Allain, M.; Roncali, J. *J. Phys. Chem. B* **2005**, *109*, 16616, and references therein. (b) Shklyaeva, E. V.; Bushueva, A. Y.; Romanova, V. A.; Abashev, G. G. *Russ. J. Org. Chem.* **2010**, *46*, 938.
46. Park, Y. S.; Kim, D.; Lee, H.; Moon, B. *Org. Lett.* **2006**, *8*, 4699, and references therein.
47. Li, J.-Y.; Chen, C.-Y.; Lee, C.-P.; Chen, S.-C.; Lin, T.-H.; Tsai, H.-H.; Ho, K.-C.; Wu, C.-G. *Org. Lett.* **2010**, *12*, 5454.
48. Turbiez, M.; Hergué, N.; Leriche, P.; Frère, P. *Tetrahedron Lett.* **2009**, *50*, 7148.
49. Chahma, M.; Myles, D. J. T.; Hicks, R. G. *Can. J. Chem.* **2005**, *83*, 150.
50. Nielsen, C. B.; Angerhofer, A.; Abboud, K. A.; Reynolds, J. R. *J. Am. Chem. Soc.* **2008**, *130*, 9734.
51. Chahma, M.; Myles, D. J. T.; Hicks, R. G. *Chem. Mater.* **2005**, *17*, 2672.
52. Nakayama, J.; Katano, N.; Shimura, Y.; Sugihara, Y.; Ishii, A. *J. Org. Chem.* **1996**, *61*, 7608.

53. (a) Chahma, M.; Hicks, R. G.; Myles, D. J. T. *Macromolecules* **2004**, *37*, 2010. (b) Myles, D. J. T.; Chahma, M.; Hicks, R. *Can. J. Chem.* **2008**, *86*, 982.
54. Mishra, S. P.; Krishnamoorthy, K.; Sahoo, R.; Kumar, A. *J. Mater. Chem.* **2006**, *16*, 3297.
55. Some selected examples can be found: (a) Ko, H. C.; Kim, S. K.; Lee, H.; Moon, B. *Adv. Funct. Mater.* **2005**, *15*, 905. (b) Blouin, N.; Leclerc, M.; Vercelli, B.; Zecchin, S.; Zotti, G. *Macromol. Chem. Phys.* **2006**, *207*, 175. (c) De Cuendías, A.; Urien, M.; Lecommandoux, S.; Wantz, G.; Cloutet, E.; Cramail, H. *Org. Electron.* **2006**, *7*, 576. (d) Idzik, K.; Beckert, R.; Golba, S.; Ledwon, P.; Lapkowski, M. *Tetrahedron Lett.* **2010**, *51*, 2396.
56. Yildirim, A.; Tarkuc, S.; Ak, M.; Toppare, L. *Electrochim. Acta* **2008**, *53*, 4875.
57. Turbiez, M.; Frère, P.; Allain, M.; Gallego-Planas, N.; Roncali, J. *Macromolecules* **2005**, *38*, 6806.
58. Lomas, J. S.; Cordier, C.; Adenier, A.; Maurel, F.; Vaissermann, J. *J. Phys. Org. Chem.* **2007**, *20*, 410.
59. Krompieca, M.; Krompieca, S.; Ignasiaka, H.; Lapkowski, M.; Kus, P.; Stanek, L.; Penczeka, R.; Lis, S.; Staninski, K.; Sajewicza, M.; Gebarowshad, K. *Synth. Met.* **2008**, *158*, 831.
60. (a) Idzik, K. R.; Ledwon, P.; Beckerta, R.; Golbac, S.; Frydele, J.; Lapkowskic, M. *Electrochim. Acta* **2010**, *55*, 7419. (b) Kim, E.; Kim, M.; Kim, K. *Tetrahedron* **2006**, *62*, 6814. (c) Kim, E.; Kim, M.; Kim, K. *Bull. Korean Chem. Soc.* **2008**, *29*, 827.
61. Krompiex, S.; Krompiex, M.; Ignasiak, H.; Lapkowski, M.; Baj, S.; Grabarczyk, D. *Catal. Commun.* **2007**, *8*, 1457.
62. Pang, H.; Skabara, P. J.; Crouch, D. J.; Duffy, W.; Heeney, M.; McCulloch, I.; Coles, S. J.; Horton, P. N.; Hursthouse, M. B. *Macromolecules* **2007**, *40*, 6585.
63. Cebeci, F. C.; Sezer, E.; Sezai Sarac, A. *Electrochim. Acta* **2007**, *52*, 2158.
64. Pina, J.; Seixas de Melo, S.; Burrows, H. D.; Batista, R. M.; Costa, S. P. G.; Raposo, M. M. *J. Phys. Chem. A* **2007**, *111*, 8574.
65. Li, J.-C.; Lee, H.-Y.; Lee, S.-H.; Zong, K.; Jin, S.-H.; Lee, Y.-S. *Synth. Met.* **2009**, *159*, 201.
66. Akpınar, H.; Balan, A.; Baran, D.; Köse Ünver, E.; Toppare, L. *Polymer* **2010**, *51*, 6123.
67. Lévesque, I.; Bertrand, P.-O.; Blouin, N.; Leclerc, M.; Zecchin, S.; Zotti, G.; Ratcliffe, C. I.; Klug, D. D.; Gao, X. *Chem. Mater.* **2007**, *19*, 2128.
68. (a) Durmus, A.; Gunbas, G. E.; Toppare, L. *Chem. Mater.* **2007**, *19*, 6247. (b) Algia, F.; Cihaner, A. *Org. Electron.* **2009**, *10*, 704. (c) Tarkuc, S.; Arslan Udumb, Y.; Toppare, L. *Polymer* **2009**, *50*, 3458. (d) Ozdemir, S.; Balan, A.; Baran, D.; Dogan, O.; Toppare, L. *J. Electroanal. Chem.* **2010**, *648*, 184. (e) Pamuka, M.; Tirkes, S.; Cihaner, A.; Algi, F. *Polymer* **2010**, *51*, 62. (f) Köse Ünver, E.; Tarkuc, S.; Arslan Udum, Y.; Tanyeli, C.; Toppare, L. *J. Polym. Sci., Part A* **2010**, *48*, 1714. (g) Tarkuc, S.; Arslan, Y.; Toppare, L. *J. Electroanal. Chem.* **2010**, *643*, 89. (h) Tarkuc, S.; Kose Ünver, E.; Arslan Udumb, Y.; Toppare, L. *Eur. Polym. J.* **2010**, *46*, 2199. (i) Matsidik, R.; Mamtimin, X.; Mi, H. Y.; Nurulla, I. *J. Appl. Polym. Sci.* **2010**, *118*, 74.
69. Nikolou, M.; Dyer, A. L.; Steckler, T. T.; Donoghue, E. P.; Wu, Z.; Heston, N. C.; Rinzler, A. G.; Tanner, D. B.; Reynolds, J. R. *Chem. Mat.* **2009**, *21*, 5539.
70. (a) Balan, A.; Gunbas, G.; Durmus, A.; Toppare, L. *Chem. Mater.* **2008**, *20*, 7510. (b) Yigitsoya, B.; Abdul Karim, S. M.; Balana, A.; Barana, D.; Toppare, L. *Synth. Met.* **2010**, *160*, 2534.
71. Içli, M.; Pamuk, M.; Algi, F.; Önal, A. M.; Cihaner, A. *Chem. Mater.* **2010**, *22*, 4034.
72. Lee, J. Y.; Heo, S. H.; Choi, H.; Kwon, Y. J.; Hawa, J. R.; Moon, D. K. *Sol. Energ. Mat. Sol. Cells* **2009**, *93*, 1932.
73. Nantalaksakul, A.; Krishnamoorthy, K.; Thayumanavan, S. *Macromolecules* **2010**, *43*, 37.
74. (a) Cabaj, J.; Idzik, K.; Soloducho, J.; Chyla, A. *Tetrahedron* **2006**, *62*, 758. (b) Kawabata, K.; Goto, H. *Synth. Met.* **2010**, *160*, 2290.
75. (a) Bezgin, B.; Onal, A. M. *Electrochim. Acta* **2010**, *55*, 779. (b) De Cuendías, A.; Ibarboure, E.; Lecommandoux, S.; Cloutet, E.; Cramail, H. *J. Polym. Sci., Part A* **2008**, 4602.
76. Atilgan, N.; Algi, F.; Önal, M.; Cihaner, A. *Tetrahedron* **2009**, *65*, 5776.
77. (a) Wei, Y.; Zhang, Q.; Jiang, Y.; Yu, J. *Macromol. Chem. Phys.* **2009**, *210*, 769. (b) Kondratenko, M.; Moiseev, A. G.; Perepichka, D. F. *J. Mater. Chem.* **2011**, *21*, 1470.
78. Song, C.; Swager, T. M. *J. Org. Chem.* **2010**, *75*, 999.
79. Some examples can be found in: (a) Cravino, A.; Roquet, S.; Aléveque, O.; Leriche, P.; Frère, P.; Roncali, J. *Chem. Mater.* **2006**, *18*, 2584. (b) Chen, C.-H.; Hsu, Y.-C.; Chou, H.-H.; Justin Thomas, K.

- R.; Lian, J. T.; Hsu, C.-P. *Chem. Eur. J.* **2010**, *16*, 3184. (c) Zeng, W.; Cao, Y.; Bai, Y.; Wang, Y.; Shi, Y.; Zhang, M.; Wang, F.; Pan, C.; Wang, P. *Chem. Mater.* **2010**, *22*, 1915. (d) Paek, S.; Choi, H.; Choi, H.; Lee, C.-W.; Kang, M.-S.; Song, K.; Nazeeruddin, M. K.; Ko, J. *J. Phys. Chem. C* **2010**, *114*, 14646. (e) Chen, L.; Zhang, B.; Cheng, Y.; Xie, Z.; Wang, L.; Jing, X.; Wang, F. *Adv. Funct. Mater.* **2010**, *20*, 3143. (f) Liang, M.; Lu, M.; Wang, Q.-L.; Chen, W.-Y.; Han, H.-Y.; Sun, A.; Xue, S. *J. Power Sources* **2011**, *196*, 1657.
80. (a) Shi, D.; Pootrakulchote, N.; Li, R.; Guo, J.; Wang, Y.; Zakeeruddin, S. M.; Grätzel, M.; Wang, P. *J. Phys. Chem. C* **2008**, *112*, 17046. (b) Yu, Q.; Liu, S.; Zhang, M.; Cai, N.; Wang, Y.; Wang, P. *J. Phys. Chem. C* **2009**, *113*, 14559. (c) Chen, C.-Y.; Pootrakulchote, N.; Wu, S.-J.; Wang, M.; Li, J.-Y.; Tsai, J.-H.; Wu, C.-G.; Zakeeruddin, S. M.; Grätzel, M. *J. Phys. Chem. C* **2009**, *113*, 20752. (d) Zhu, X. J.; Holliday, B. *Macromol. Rapid. Commun.* **2010**, *31*, 904.
 81. Algi, F.; Cihaner, A. *Org. Electron.* **2009**, *10*, 453.
 82. (a) Aldakov, D.; Palacios, M. A.; Anzenbacher, P., Jr. *Chem. Mater.* **2005**, *17*, 5238. (b) Chahma, M.; Gilroy, J. B.; Hicks, R. G. *J. Mater. Chem.* **2007**, *17*, 4768. (c) Chen, B.-S.; Chen, D.-Y.; Chen, C.-L.; Hsu, C.-W.; Hsu, H.-C.; Wu, K.-L.; Liu, S.-H.; Chou, P.-T.; Chi, Y. *J. Mater. Chem.* **2011**, *21*, 1937. (d) Lu, M.; Liang, M.; Han, H.-Y.; Sun, Z.; Xue, S. *J. Phys. Chem. C* **2011**, *115*, 274.
 83. Stanley, J. M.; Zhu, X.; Yang, X.; Holliday, B. J. *Inorg. Chem.* **2010**, *49*, 2035.
 84. Liu, W.; Pink, M.; Lee, D. *J. Am. Chem. Soc.* **2009**, *131*, 8703.
 85. Stolić, I.; Misković, K.; Piantanida, I.; Loncar, M. B.; Glavas-Obrovac, L.; Bajić, M. *Eur. J. Med. Chem.* **2011**, *46*, 743.
 86. Selected example: Byrne, P. D.; Lee, D.; Müller, P.; Swager, T. M. *Synth. Met.* **2006**, *156*, 784.
 87. Hergué, N.; Mallet, C.; Frère, P.; Allain, M.; Roncali, J. *Macromolecules* **2009**, *42*, 5593.
 88. Oçafrain, M.; Tran, T. K.; Blanchard, P.; Lenfant, S.; Godey, S.; Vuillaume, D.; Roncali, J. *Adv. Funct. Mater.* **2008**, *18*, 2163.
 89. Joussetme, B.; Blanchard, P.; Levillain, E.; de Bettignies, R.; Roncali, J. *Macromolecules* **2003**, *36*, 3020.
 90. Moggia, F.; Brisset, H.; Fages, F.; Blanchard, P.; Roncali, J. *Electrochem. Comm.* **2006**, *8*, 533.
 91. Moggia, F.; Fages, F.; Brisset, H.; Chaix, C.; Mandrand, B.; Levillain, E.; Roncali, J. *J. Electroanal. Chem.* **2009**, *626*, 42.
 92. Demeter, D.; Blanchard, P.; Allain, M.; Grosu, I.; Roncali, J. *J. Org. Chem.* **2007**, *72*, 5285.
 93. (a) Joussetme, B.; Blanchard, P.; Gallego-Planas, N.; Delaunay, J.; Allain, M.; Richomme, P.; Levillain, E.; Roncali, J. *J. Am. Chem. Soc.* **2003**, *125*, 1363. (b) Joussetme, B.; Blanchard, P.; Gallego-Planas, N.; Delaunay, J.; Allain, M.; Richomme, P.; Levillain, E.; Roncali, J. *J. Am. Chem. Soc.* **2003**, *125*, 2888. (c) Joussetme, B.; Blanchard, P.; Gallego-Planas, N.; Levillain, E.; Delaunay, J.; Allain, M.; Richomme, P.; Roncali, J. *Chem. Eur. J.* **2003**, *9*, 5297.
 94. Selected examples can be found in: (a) Turbiez, M.; Frère, P.; Allain, M.; Videtot, C.; Ackermann, J.; Roncali, J. *Chem. Eur. J.* **2005**, *11*, 3742. (b) Clot, O.; Selmarten, D.; McNevin, M. J. *J. Mater. Chem.* **2005**, *15*, 4934.
 95. Melucci, M.; Frère, P.; Allain, M.; Levillain, E.; Barbarella, G.; Roncali, J. *Tetrahedron* **2007**, *63*, 9774.
 96. McEntee, G. J.; Skabara, P. J.; Vilela, F.; Tierney, S.; Samuel, D. W. I.; Gambino, S.; Coles, S. J.; Hurthouse, M. B.; Harrington, R. W.; Clegg, W. *Chem. Mater.* **2010**, *22*, 3000.
 97. (a) Leriche, P.; Piron, F.; Ripaud, E.; Frère, P.; Allain, M.; Roncali, J. *Tetrahedron Lett.* **2009**, *50*, 5673. (b) Rapta, P.; Idzik, K. R.; Lukes, V.; Beckert, R.; Dunsch, L. *Electrochem. Commun.* **2010**, *12*, 513. (c) Idzik, K. R.; Rapta, P.; Cywinski, P. J.; Beckert, R.; Dunsch, L. *Electrochim. Acta* **2010**, *55*, 4858.
 98. Taerum, T.; Lukyanova, O.; Wylie, R. G.; Perepichka, D. F. *Org. Lett.* **2009**, *11*, 3230.
 99. Kanibolotsky, A. L.; Forgie, J. C.; McEntee, G. J.; Talpur, M. A. A.; Skabara, P. J.; Westgate, T. D. J.; McDowall, J. J. W.; Auinger, M.; Coles, S. J. *Chem. Eur. J.* **2009**, *15*, 11581.
 100. Karpe, S.; Cravino, A.; Frère, P.; Allain, M.; Mabon, G.; Roncali, J. *Adv. Funct. Mater.* **2007**, *17*, 1163.

101. (a) Piron, F.; Leriche, P.; Grosb, I.; Roncali, J. *J. Mater. Chem.* **2010**, *20*, 10260. (b) Leriche, P.; Aillerie, D.; Roquet, S.; Allain, M.; Cravino, A.; Frère, P.; Roncali, J. *Org. Biomol. Chem.* **2008**, *6*, 3202.
102. (a) Ikeda, T.; Higuchi, M.; Kurth, D. G. *J. Am. Chem. Soc.* **2009**, *131*, 9158. (b) Kwan, P. H.; Swager, T. M. *J. Am. Chem. Soc.* **2005**, *127*, 5902.
103. Melucci, M.; Zambianchi, M.; Barbarella, G.; Manet, I.; Montalti, M.; Bonacchi, S.; Rampazzo, E.; Rambaldi, D. C.; Zattonide, A.; Reschiglian, P. *J. Mater. Chem.* **2010**, *20*, 9903.
104. (a) Chevallier, F.; Charlot, M.; Katan, C.; Mongin, F.; Blanchard-Desce, M. *Chem. Commun.* **2009**, 692. (b) Wang, J.-L.; Duan, X.-F.; Jiang, B.; Gan, L.-B.; Pei, J.; He, C.; Li, Y.-F. *J. Org. Chem.* **2006**, *71*, 4400.
105. (a) Steckler, T. T.; Abboud, K. A.; Craps, M.; Rinzler A. G.; Reynolds, J. R. *Chem. Commun.*, **2007**, 46, 4904. (b) Huo, L. J.; Zhou, Y.; Li, Y. F. *Macromol. Rapid Commun.* **2008**, *29*, 1444. (c) Guo, X. G.; Kim, F. S.; Jenekhe, S. A.; Watson, M. D. *J. Am. Chem. Soc.* **2009**, *131*, 7206. (d) Peet, J.; Senatore, M. L.; Heeger, A. L.; Bazan, G. C. *Adv. Mater.* **2009**, *21*, 1521.
106. (a) Beaujuge, P. M.; Ellinger, S.; Reynolds, J. R. *Nat. Mater.* **2008**, *7*, 796. (b) Meng, H.; Tucker, D.; Chaffins, S.; Chen, Y.; Helgeson, R.; Dunn, B. *Adv. Mater.* **2003**, *15*, 146. (c) Bokria, J. G.; Kummar, A.; Seshadri, V.; Tran, A.; Sotzing, G. A. *Adv. Mater.* **2008**, *20*, 1175. (d) Thompson, B. C.; Kim, Y.G.; Reynolds, J. R. *Macromolecules* **2005**, *38*, 5359.
107. (a) Beaujuge, P. M.; Ellinger, S.; Reynolds, J. R. *Adv. Mater.* **2008**, *20*, 2772. (b) Berlin, A.; Zotti, G.; Zecchin, S.; Schiavon, G.; Vercelli, B.; Zanelli, A. *Chem. Mater.* **2004**, *16*, 3667. (c) Sonmez, G.; Meng, H.; Wudl, F. *Chem. Mater.* **2003**, *15*, 4923. (d) Colladet, K.; Fourier, S.; Cleij, T. J.; Lutsen, L.; Gelan, J.; Vanderzande, D. *Macromolecules* **2007**, *40*, 65. (e) Lee, J. Y.; Heo, S. W.; Choi, H.; Kwon, Y. J.; Haw, J. R.; Moon, D. K. *Sol. Energ. Mater. Sol. Cell* **2009**, *93*, 1932.
108. (a) Wang, X.; Perzon, E.; Oswald, F.; Langa, F.; Admassie, S.; Andersson, M. R. *Adv. Funct. Mater.* **2005**, *15*, 1665. (b) Wienk, M. M.; Turbiez, M. R.; Struijk, M. P.; Fonrodona, M.; Janssen, R. A. J. *Appl. Phys. Lett.* **2006**, *511*, 576. (c) Boudreault, P.-L.T.; Najari, A.; Leclerc, M. *Chem. Mater.* **2011**, *23*, 456.
109. (a) Bolognesi, A.; DiGianvincenzo, P.; Giovanella, U.; Mendichi, R.; Giacometti Schieronni, A. *Eur. Polymer. J.* **2008**, *44*, 793. (b) Choi, H.; Lee, J. K.; Song, K. H.; Song, K.; Kang, S. O.; Ko, J. *Tetrahedron* **2007**, *63*, 1553. (c) Zulauf, A.; Mellah, M.; Guillot, R.; Schulz, E. *Eur. J. Org. Chem.* **2008**, 2118.
110. Liu, W.-H.; Wu, I.-C.; Lai, C.-H.; Lai, C.-H.; Chou, P.-T.; Li, Y.-T.; Chen, C.-L.; Hsu, Y.-Y.; Chi, Y. *Chem. Commun.* **2008**, 5152.
111. Huang, C.-H.; McClenaghan, N. D.; Kuhn, A.; Hofstraat, J. W.; Bassani, D. M. *Org. Lett.* **2005**, *7*, 3409.
112. (a) Borghese, A.; Geldhof, G.; Antoine, L. *Tetrahedron Lett.* **2006**, *47*, 9249. (b) Amaladass, P.; Arul Clement, J.; Mohanakrishnan, A. K. *Tetrahedron* **2007**, *63*, 10363. (c) Mohanakrishnan, A. K.; Amaladass, P.; Arul Clement, J. *Tetrahedron Lett.* **2007**, *48*, 539.
113. Wenger, S.; Bouit, P.-A.; Chen, Q.; Teuscher, J.; Censo, D. D.; Humphry-Baker, R.; Moser, J.-E.; Delgado, J. L.; Martín, N.; Zakeeruddin, S. M.; Grätzel, M. *J. Am. Chem. Soc.* **2010**, *132*, 5164.
114. (a) Wong, W.-Y.; Wang, X.; Zhang, H.-L.; Cheung, K.-Y.; Fung, M.-K.; Djuricic, A. B.; Chan, W.-K. *J. Organomet. Chem.* **2008**, *693*, 3603. (b) Mei, J.; Ogawa, K.; Kim, Y.-G.; Heston, N. C.; Arenas, D. J.; Nasrollahi, Z.; McCarley, T. D.; Tanner, D. B.; Reynolds, J. R.; Schanze, K. S. *Appl. Mater. Interfaces* **2009**, *1*, 150.
115. Kim, K.-Y.; Shelton, A. H.; Drobizhev, M.; Makarov, N.; Rebane, A.; Schanze, K. S. *J. Phys. Chem. A.* **2010**, *114*, 7003.
116. Brand, J. P.; Waser, J. *Angew. Chem. Int. Ed.* **2010**, *49*, 7304.
117. Kita, Y.; Morimoto, K.; Ito, M.; Ogawa, C.; Goto, A.; Dohi, T. *J. Am. Chem. Soc.* **2009**, *131*, 1668.
118. Arroyave, F. A.; Reynolds, J. R. *Org. Lett.* **2010**, *12*, 1328.
119. Mohanakrishnan, A. K.; Hucke, A.; Lyon, M. A.; Lakshmikantham, M. V.; Cava, M. P. *Tetrahedron* **1999**, *55*, 11745.
120. Rajeshwaran, G. G.; Nandakumar, M.; Sureshbabu, R.; Mohanakrishnan, A. K. *Org. Lett.* **2011**, *13*, 1270.

121. (a) Li, G.; Jiang, K.; Bao, P.; Li, Y.; Lia, S.; Yang, L. *New J. Chem.* **2009**, *33*, 868. (b) Jiang, K.-J.; Manseki, K.; Yu, Y.-H.; Masaki, N.; Xia, J.-B.; Yang, L.-M.; Song, Y.-l.; Yanagida, S. *New J. Chem.* **2009**, *33*, 1973.
122. Abbotto, A.; Herrera Calderón, H.; Dangate, M. S.; De Angelis, F.; Manfredi, N.; Mari, C. M.; Marinzi, C.; Mosconi, E.; Muccini, M.; Ruffo, R.; Seri, M. *Macromolecules* **2010**, *43*, 9698.
123. Tsao, M.-H.; Wu, T.-Y.; Wang, H.-P.; Sun, I.-W.; Su, S.-G.; Lin, Y.-C.; Chang, C.-W. *Mater. Lett.* **2010**, *65*, 583.

RECENT APPLICATION OF ISATINS IN SYNTHESIS OF FUNCTIONALIZED SPIROCYCLIC OXINDOLES

Fliur Macaev,^a Athina Geronikaki^b and Natalia Sucman^a

^a*Institute of Chemistry of the Academy of Sciences of Moldova, Academy str. 3, MD-2028, Chisinau, Moldova (e-mail: flmacaev@cc.acad.md)*

^b*Aristotelian University of Thessaloniki, Thessaloniki Gr-54124, Greece (e-mail: geronik@pharm.auth.gr)*

Abstract. *Recent advances in the entry to diversely functionalized spirocyclic oxindoles from isatins are surveyed.*

Contents

1. Introduction
 2. Structure and occurrence
 3. Three-membered spirooxindoles
 - 3.1. Cycloaddition
 - 3.1.1. Catalysts free
 - 3.1.2. Metal catalysis
 - 3.1.3. Organocatalysis
 - 3.1.4. Ylide approach
 - 3.2. Ring closing
 4. Four-membered spirooxindoles
 5. Five-membered spirooxindoles
 - 5.1. Cycloaddition
 - 5.1.1. Dipolar additions
 - 5.1.2. Metal catalysis
 - 5.1.3. Organocatalysis
 - 5.1.4. Catalysts free
 6. Six-membered spirooxindoles
 - 6.1. Cycloaddition
 - 6.1.1. Lewis base or acid catalysts
 - 6.1.2. Organocatalysis
 - 6.2. Ring closing
 7. Seven-membered spirooxindoles
 8. Biological activity of discussed spirocyclic oxindoles
 9. Conclusions
- Acknowledgments
- References

1. Introduction

The continuing stream of publications about functionalized spirocyclic oxindoles during the last two decades has prompted us to update our previous review.¹ Isatines adducts occur as intermediates in synthesis

of heterocycles of wide application. The general philosophy and format of this review are similar to the former one, but it will be focused more on the type of construction of spirocyclic system from isatines. The sections in chapters are divided taking into account the size of the ring. Subdivisions are including the type of reactions: cycloaddition or ring closing, metal catalysis or organocatalysis as well as catalysts free approach. It is worth noting that we have not provided an exhaustive treatment of all possible heterocyclic spiro-oxindole ring systems according to the size of the ring at the 3-position of the oxindole core, due to the existence of excellent reviews.^{2–18}

2. Structure and occurrence

The name spirocyclic oxindole corresponds to heterocyclic compounds with the structure **2** depicted in Figure 1. This name is derived from oxindole **1**, which was first synthesized by K. Baeyer *via* reduction of isatin **3**.¹⁹ This structure **3** was found to be present in natural products. Some important and well known natural spirocyclic oxindoles **4–10** are shown in Figure 1.

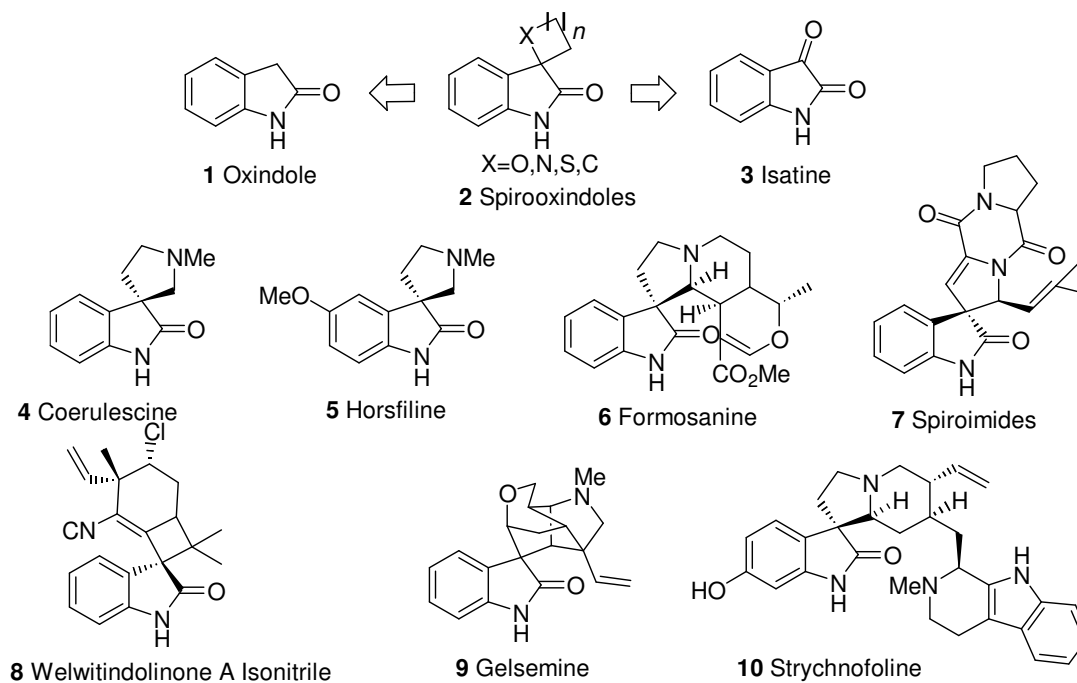

Figure 1

Nowadays many natural spirooxindoles are known and several of these have useful biological activities. They have been isolated from numerous species of many plant families.^{1,6,7,10,15,16,18,20–23} However, the natural occurrence of spirooxindoles is not limited to plants. They have also been found in microorganisms.^{24,25}

In the present review, we discuss or focus our interest on different strategies for the synthesis of three-, four-, five- and six-membered cycles having a spiro connection to the 3-position of the oxindole core. Based on the biological importance of chirality, pharmaceutical and agrochemical industries invest heavily into development of asymmetric approaches. However, in this review no sub-division between racemic and enantiopure spirocyclic oxindoles will be made because it has been done shortly.^{3–5,7,11,17,18} In view of the therapeutic potential of spiro-cyclic oxindoles, some miscellaneous biological activities are described in the final section.

3. Three-membered spirooxindoles

The construction of cyclopropane ring systems is of great interest for organic chemists due to its existence as a basic unit in a number of natural products.^{8,26} Furthermore, cyclopropane ring systems are versatile building blocks in complex molecular construction. In view of their importance as synthons, numerous synthetic methods have been reported.^{8,27–29}

3.1. Cycloaddition

3.1.1. Catalysts free

One of the methods for the synthesis of three-membered spirooxindoles is cycloaddition reaction which was used for the synthesis of olefins **12a** and **12b** in a standard way from isatin **11** and Wittig reagent. Cycloaddition of CH_2N_2 to a mixture of **12a,b** afforded diastereoisomeric spiranes **13a,b**. Several analogs **14a–e** with substitutions at C^5 position of the oxindole system were also prepared starting from bromide **13b** (Scheme 1). On the other hand, olefin **12b** can be converted into the bulky cyclopropanes **15a–e**. For this reason *E*- and *Z*-isomers **12a** and **12b** should be separated before following interactions with Wittig reagents.

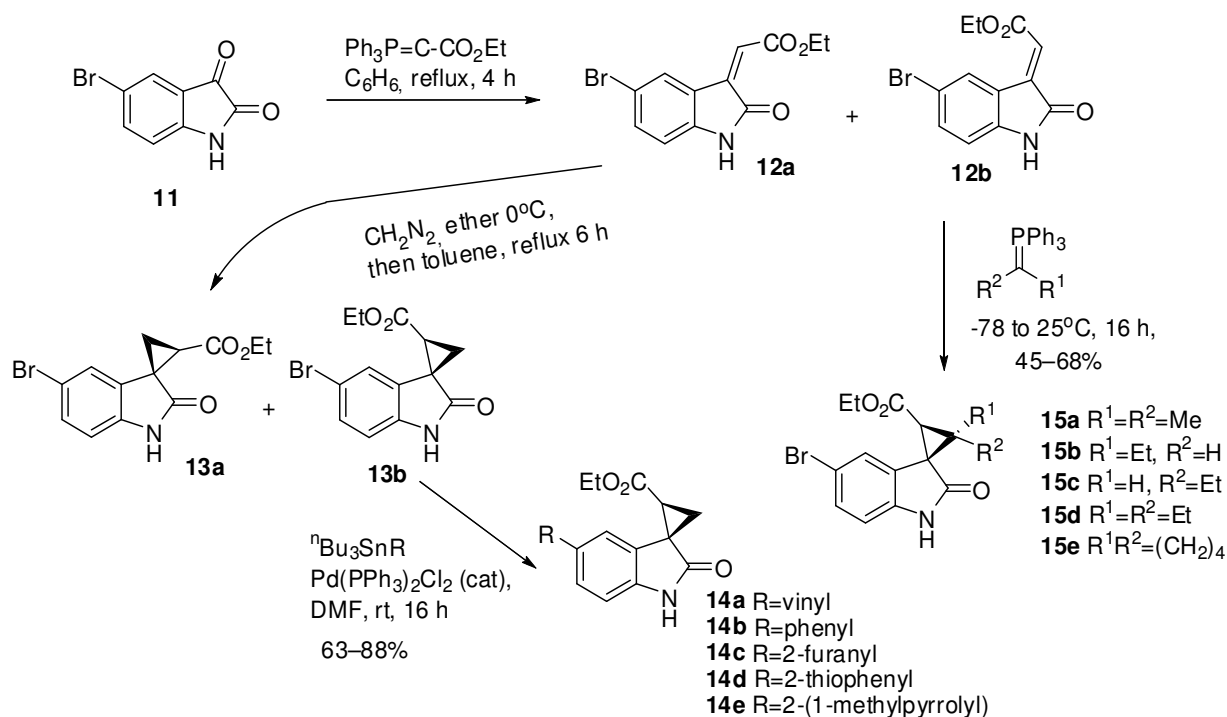

Scheme 1

Preliminary results showed that some of the spirooxindoles thus synthesized (**15a**, **13b**) display good anti-HIV activity. Taking into account that synthesized compounds exhibited extremely high clearance, low exposure and low oral bioavailability, the authors undertook bioisosteric substitution of the ester moiety.³⁰

Reaction of isatin **16** with various aryl or heteroaryl aldehydes furnished the corresponding olefins **17b**. Wittig reaction of isatin **16** afforded the corresponding olefin **17a** in excellent yield. Further olefins **17a,b** reacted with diazomethane or 2-diazopropane to give various analogs **19–21**. Additionally, nitrile **18** reacted with N_3SnMe_3 to afford tetrazole **21a** in excellent yield. Methylation of **21a** using diazomethane led to compounds **21b,c** in ratio 2:1 (Scheme 2).

Some of these analogs exhibited potent inhibitory activities against both wild-type virus and a number of drug-resistant mutant viruses. In addition, oxindole **20f** also showed promising pharmacokinetic properties.

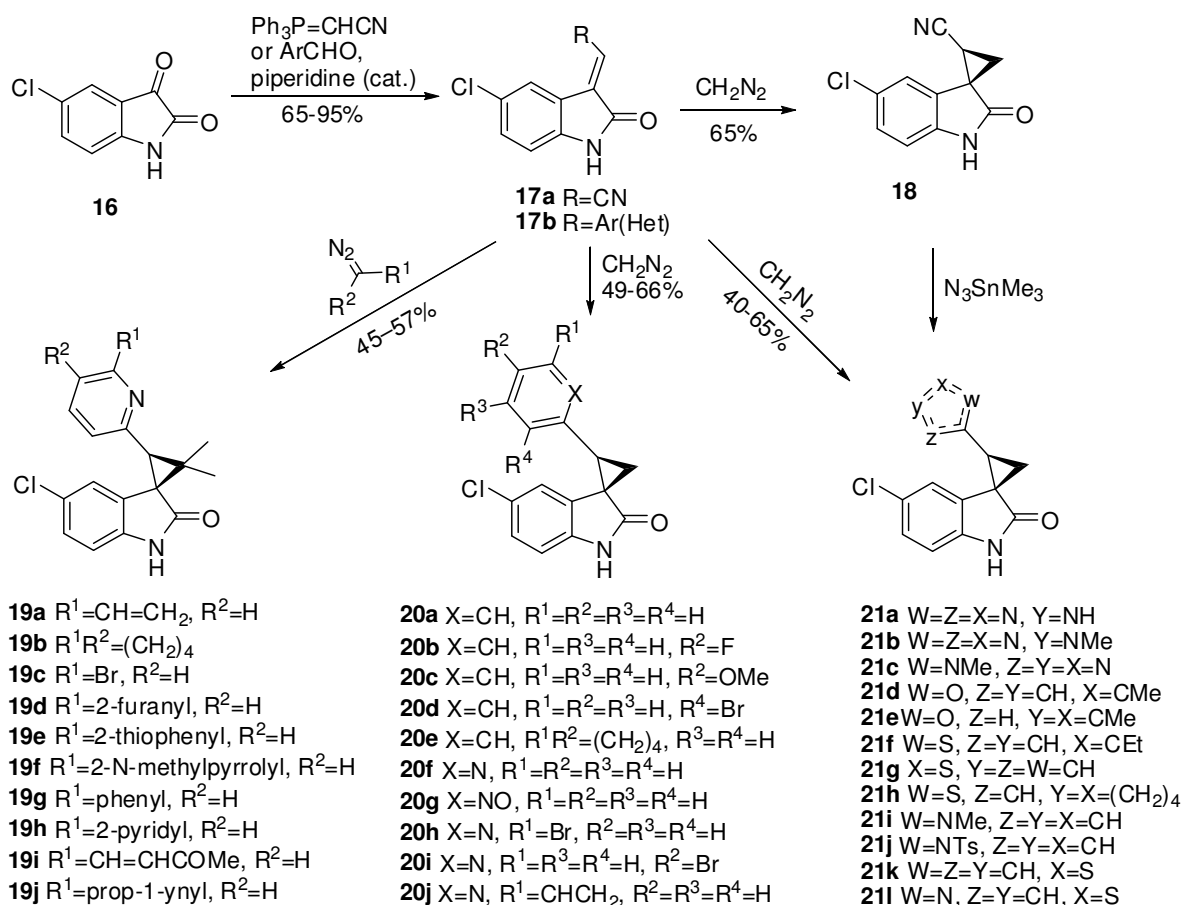

Scheme 2

3.1.2. Metal catalysis

In order to prepare HIV non-nucleoside reverse transcriptase inhibitors, other groups synthesized spirooxindoles **25a–i**, **26a–h**, **24a–f** via metal-catalyzed cycloaddition of diazoisatines **23** to different olefins (Scheme 3).^{31–33}

So, spirooxindoles **24a–f** were synthesized via rhodium(II) acetate-catalyzed approach, using olefins with inactive double bond,³¹ as well as spirooxindoles **25a–i**, **26a–h** from olefins with activated double bond^{32,33} (Scheme 3).

Trans-isomers **25a–i** were formed as the major products together with a small amount of *cis*-compounds **26a–h** and alkenes **27**.³² The protocol for the preparation of major *cis*-cyclopropane **26i** from diazolactam **23** (R¹=H) and methyl acrylate-catalyzed by Pd(OAc)₂ was reported.³⁴

It is worth noting that the oxindole derivatives featuring spiro-cyclopropanes **25k–o** and **26k–o** and **26** became a focus of our attention due to their promising activity as HIV-1 integrase inhibitors.³⁵

Catalyzed reaction of diazoamides **31a–d** with cyclic olefins or heteroaromatic systems furnished a variety of spiro-cyclopropanooxindoles **28a**, **30c**, **32a–d**, **33a–d** in a diastereoselective manner (Scheme 4).³⁶

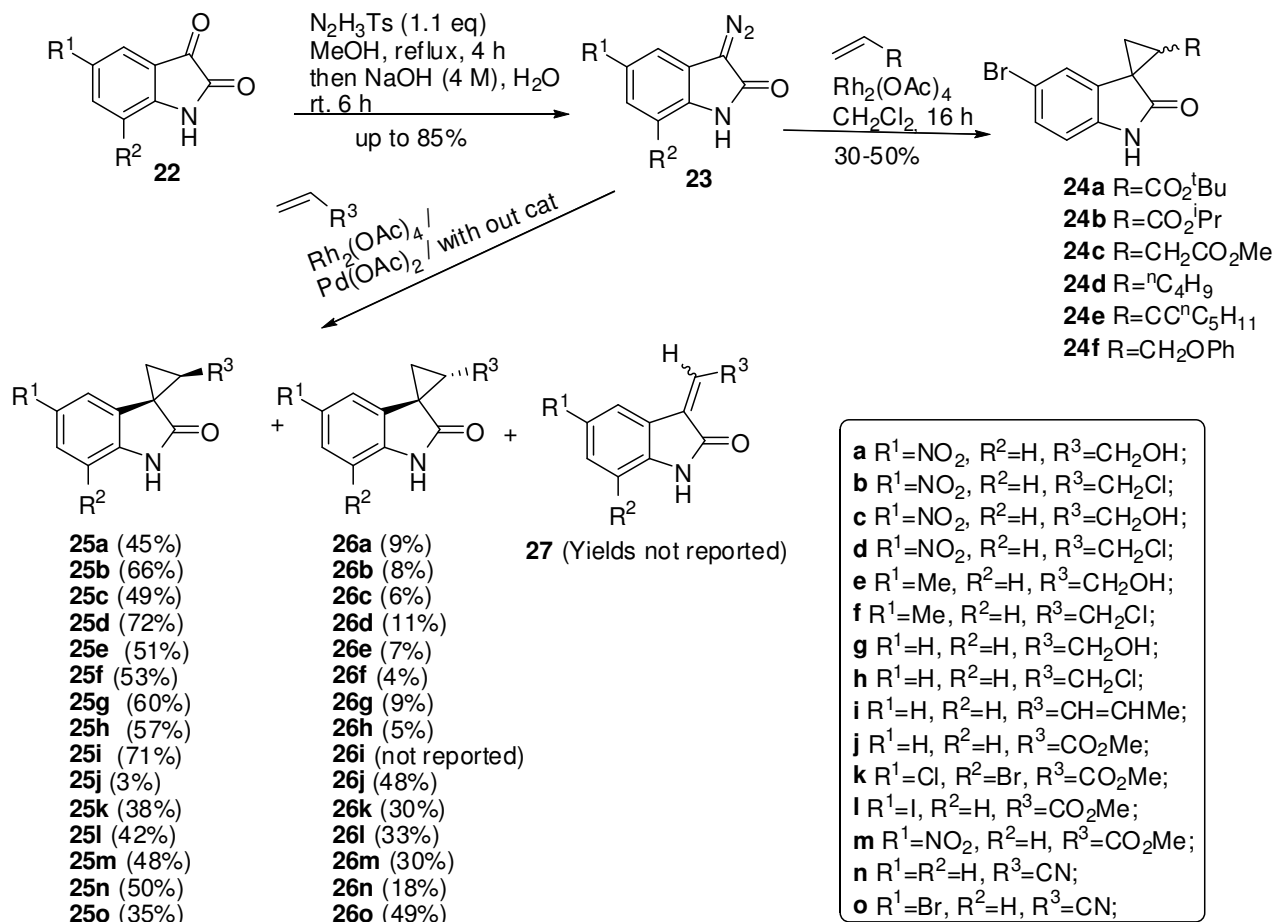

Scheme 3

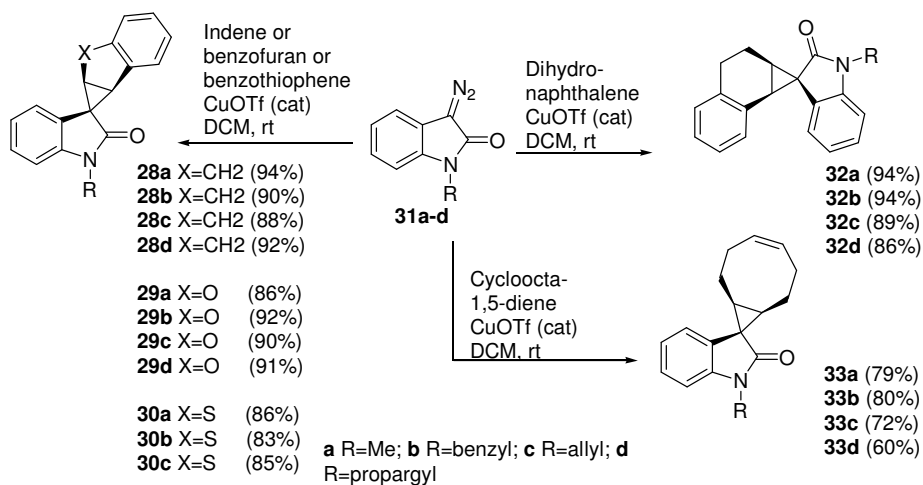

Scheme 4

An investigation of the influence of catalysts on the cycloaddition revealed that copper(I) triflate is more active than rhodium(II) acetate.

Spiroaziridine-oxindoles **36a–j** have been prepared from isatins **34a–j** by treatment of 3-ylidene-oxindoles **35a–j** with *N*-{[(4-nitrophenyl)sulfonyl]oxy}carbamate in the presence of CaO (Scheme 5).³⁷ With the aim of accessing aziridine derivatives bearing a more easily removable protecting group on nitrogen, *N*-Boc-protected spiroaziridines **36h–j** were obtained as pure materials in good yields without any need for further purification.³⁷

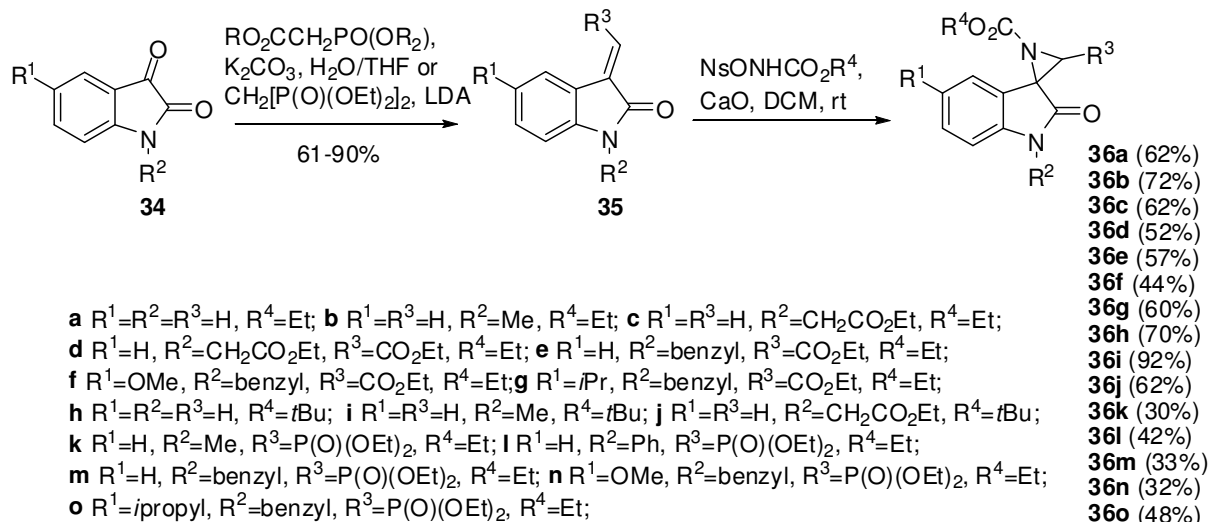

Scheme 5

Spiro-fused oxindoles with an aziridine-2-phosphonates **36k–o** have been prepared by treatment of the corresponding 3-(phosphorylmethylene)oxindoles **35** (R³=P(O)(OEt)₂) with NsONHCO₂Et analogously with a previous synthesis.³⁸

3.1.3. Organocatalysis

An enantioselective synthesis of spiro nitrocyclopropane oxindoles **38a–i** from olefins **37** by use of organocatalytic Michael-alkylation cascade reactions was reported (Scheme 6).³⁹

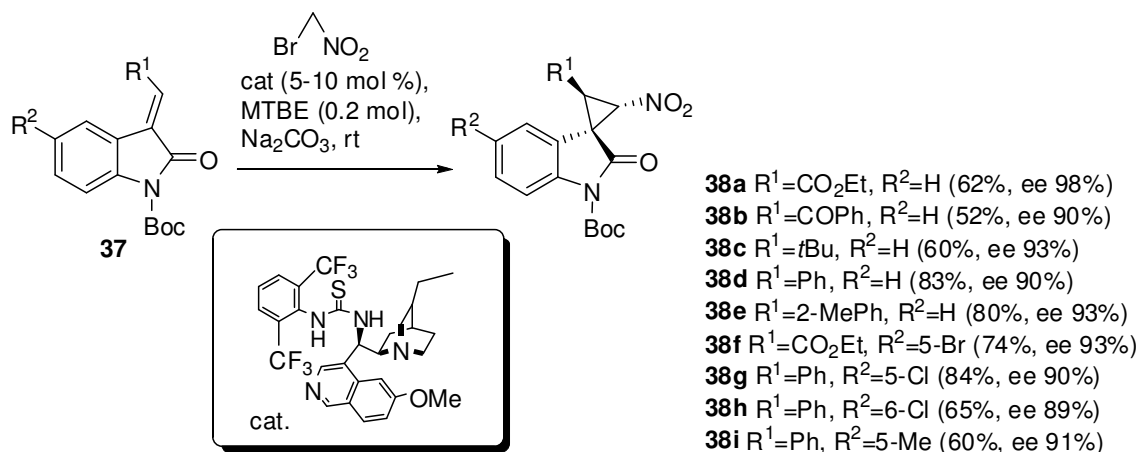

Scheme 6

The authors believe that the high diastereo- and enantioselectivity observed in the course of the reaction is due mainly to the ability of the bifunctional catalyst to activate the Michael donor and electrophilic oxindole simultaneously. A reaction mechanism is proposed in which hydrogen-bond interaction between the N–H bonds of the thiourea moiety and the imidic carbonyl groups of the oxindole, plays a crucial role in the stereochemical outcome of the reaction.

Spiro cyclopropyl oxindoles with two quaternary stereogenic centres could be synthesized in optically active form (with ee values ranging from 89 to >98%) in high yields, with good diastereocontrol.

3.1.4. Ylide approach

Another way for the synthesis of three-membered spirooxindoles is the use of ylides. A one-pot approach for the stereoselective construction of spirocyclopropyl oxindoles **40a–k** from isatins **39** and arsonium salts has been reported (Scheme 7).⁴⁰ The use of arsonium salts has some advantages compared to a normal Wittig ylide. They decrease the reaction time (not 16 hours but up to 1 hour), number of synthetic steps, waste produced, mild reaction condition (not $-78\text{ }^{\circ}\text{C}$ but room temperature), high to excellent yields of products in the last step (75–98% and not 45–68% as in a common Wittig ylide) as well as high stereoselectivity.

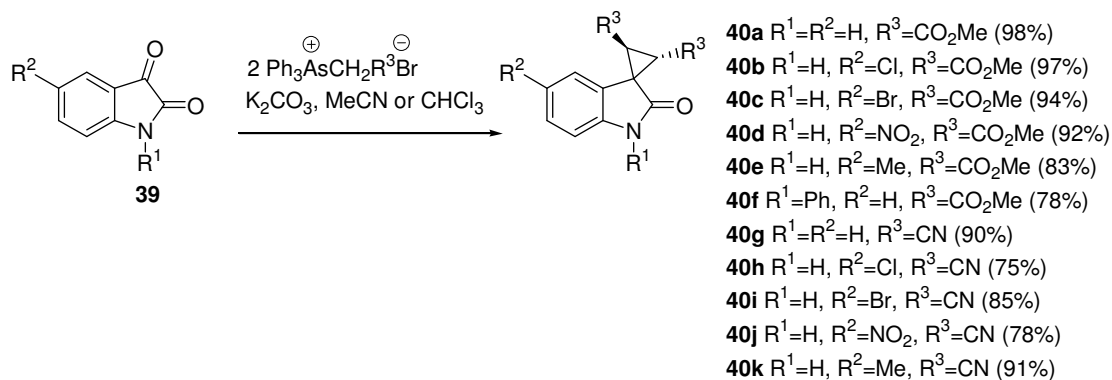

Scheme 7

The reaction proceeded smoothly and target compounds were isolated in high yields. Even for N-Ph substituted isatin **40f**, the reaction was complete within 1 hour with 78% yield. However, when an N-acyclic substrate was used, no cyclopropane products were observed.

A one-pot epoxidation protocol using a sulfur ylide derived from bromo-acetamide **41** and corresponding isatins as substrates was evaluated (Scheme 8).⁴¹

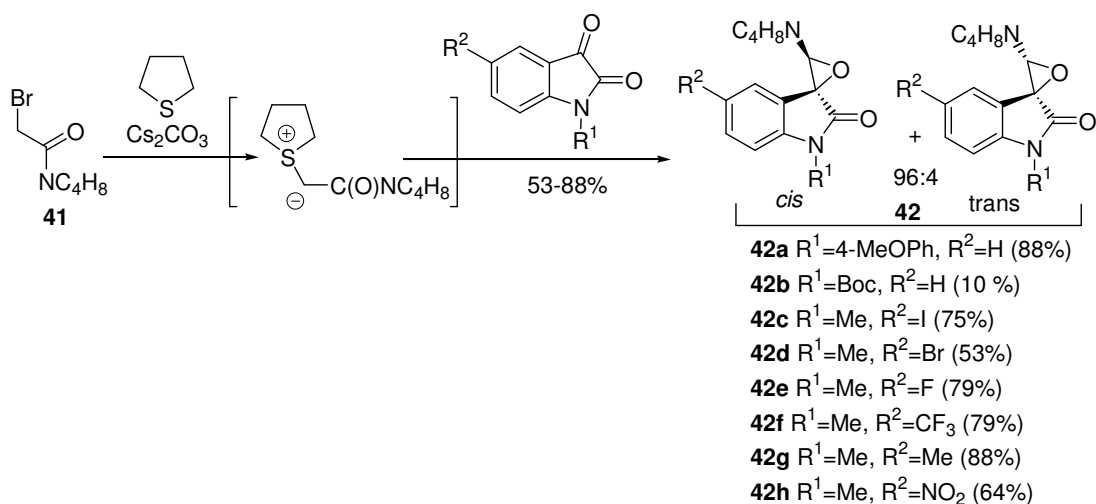

Scheme 8

It was observed that no reaction occurred without addition of the thiolane. In general, a decrease in yield of target spiro-epoxyoxindoles **42a–h** was observed with isatins having an electron-withdrawing group at C-5. It is worth noting that this is one of the rare examples of a catalytic amide-stabilized sulfonium ylide epoxidation affording glycidic amides in metal-free conditions.

The synthesis of pyridyl-substituted spiro-cyclopropaneoindoles **44–46** was described (Scheme 9).⁴²

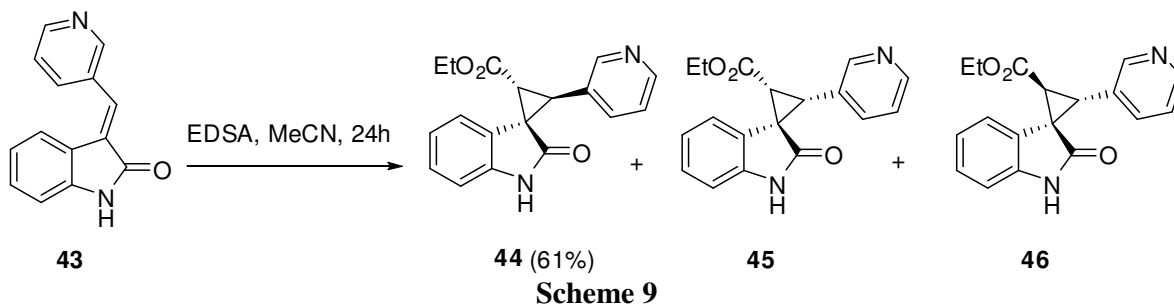

This synthesis involves reactions of (3*E*)-(pyridin-3-ylmethylene)-1,3-dihydro-2*H*-indol-2-one **43** with ethyl (dimethyl, sulfuranylidene) acetate. The cyclopropanation reaction gave a 43:7:1 mixture of the diastereomeric products **44**, **45** and **46**, respectively. The major *trans*-isomer **44** was readily isolated in diastereomerically pure form in 61% yield, although diastereomerically pure samples of the isomers **45** and **46** could not be obtained from the inseparable mixtures.

3.2. Ring closing

The mixture of major *cis*-isomers **49** and minor *trans*-isomers **50** or reduced products **51** was prepared by magnesium iodide-mediated cyclopropanation of adducts **48a–c** (Scheme 10).⁴³ The bromo-derivatives of isatins **47a–f** could be synthesized from the Baylis-Hillman adducts using 46% aqueous HBr under microwave irradiation.^{44–48}

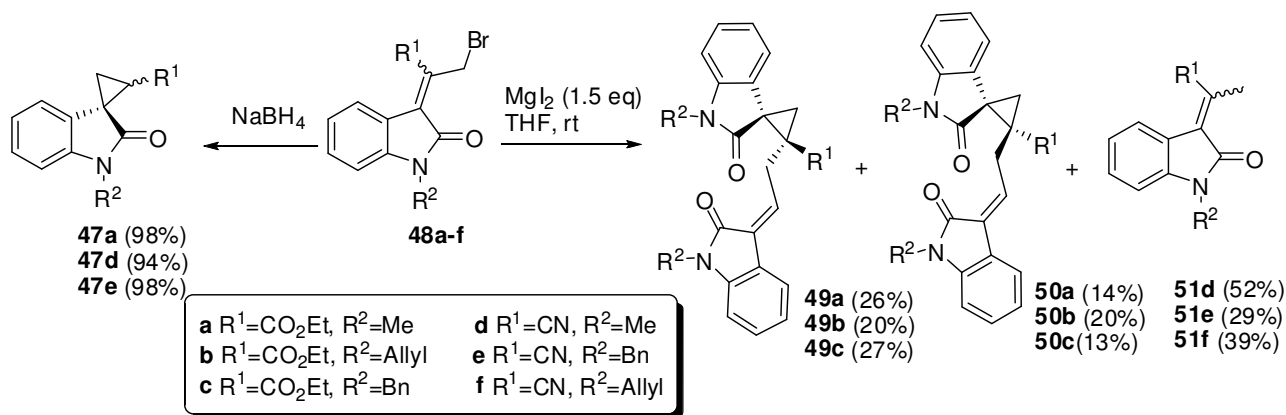

Scheme 10

Cyclopropane formation from the of mixture of *E*- and *Z*-isomers **48a,d,e** in dry THF with sodium borohydride (2 equiv) at room temperature for 0.5 hours afforded functionalized spirocyclopropyl-2-indolones **47a,d,e** as diastereomeric mixtures in 93–98% combined yields.⁴⁸

Diastereomeric three-membered spirocyclopropylindoles **52a** and **53b** were synthesized using 2-(2-oxoindolin-3-yl)acetonitrile **52** and dibromomethane, after a one-pot base mediated double-alkylation strategy, according to Scheme 11.⁴⁹

In conclusion, the development of efficient strategies and synthetic routes to three-membered spiro-oxindole system has received increased attention as a result of the important biological activity displayed by several of these compounds (see part 7 of current review).

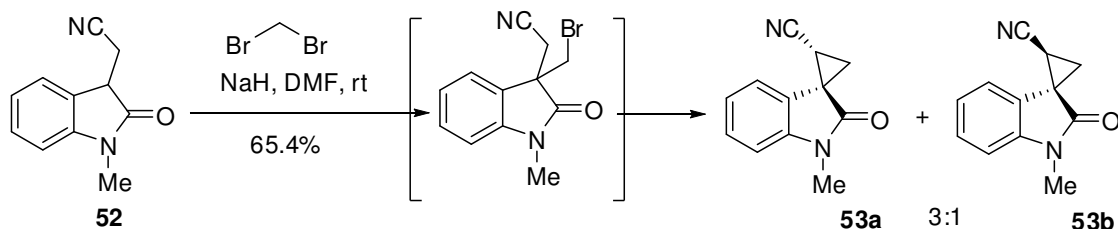

Scheme 11

4. Four-membered spirooxindoles

Organic reactions in the crystalline state have been known for more than hundred years and, among them, photodimerizations have received considerable attention. However, the first example of a photodimerization of oxindoles was published only in 2000.⁵⁰

It was observed that compound **54a** can be conveniently photodimerized in the solid state (Scheme 12).

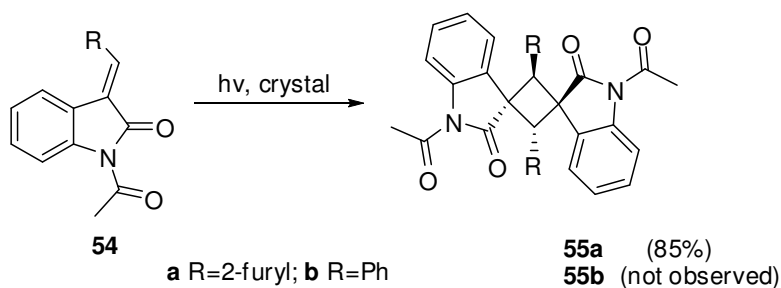

Scheme 12

The reaction was found to lead selectively to the formation of only one product **55a** while the formation of its phenyl analogue **55b** was not observed. It was found that the factors that prevent photoreaction in the case of **55b** are the twist of the phenyl ring with respect to the oxindole moiety, the interaction between a phenyl proton and the π cloud of the six-membered rings in the oxindole nucleus of a facing molecule, the relatively high cohesion energy and the low interaction energy between facing molecules in the crystal.

While diastereomeric three-membered spirocyclomethyloxindoles **53a,b** were synthesized using 2-(2-oxo-indolin-3-yl)acetonitrile **52** and dibromoethane, after a one-pot base mediated double-alkylation (see Scheme 11), the attempt to use this method for the construction of four-membered spirocycloalkyloxindoles failed. Only traces of the target homologated analogue were detected after reaction of **52** with 1,2-dibromo-ethane.⁴⁹

5. Five-membered spirooxindoles

Five-membered spirooxindoles are a structurally complex family of bioactive compounds including alkaloids; several of its members possess potent anthelmintic and antinematodal activity and have garnered some interest for their use in veterinary to treat intestinal parasites.¹

5.1. Cycloaddition

A widely employed method for the construction of the spiropyrrolidine-oxindole ring system is based on the use of 1,3- or 2-3-dipolar cycloadditions.^{7,15-18}

5.1.1. Dipolar additions

1,3-Dipolar cycloadditions have been used by a number of research groups for the synthesis of the spiro[pyrrolidine-3,3-oxindole] skeleton.⁵¹⁻⁶⁷ Thus, the 1,3-dipolar cycloaddition of azomethine ylides generated *in situ* from the reaction of isatins **56** with sarcosine and different dipolarophiles afforded chromeno[3,4-*c*]spiropyrrolidine-oxindoles **57a**, (aryl)pyrrolo(spiro[2.3']oxindole)-spiro[3.3']-10-methylpiperidin-4'-ones **57b-e**, dispiropyrrolidine bisoxindoles **57f,g**, spiro-oxindole ketoxime derivatives **57h**, bis[3-spiro-3'-pyrrolidine]oxindoles **57i**, dispiro pyrrolidino-oxindolo andrographolide **57j** and ferrocenyl-monospirooxindolopyrrolidines, dioxindole derivatives **57k,l**, respectively, in excellent yields in a regio- and stereoselective manner (Scheme 13).⁵¹⁻⁶²

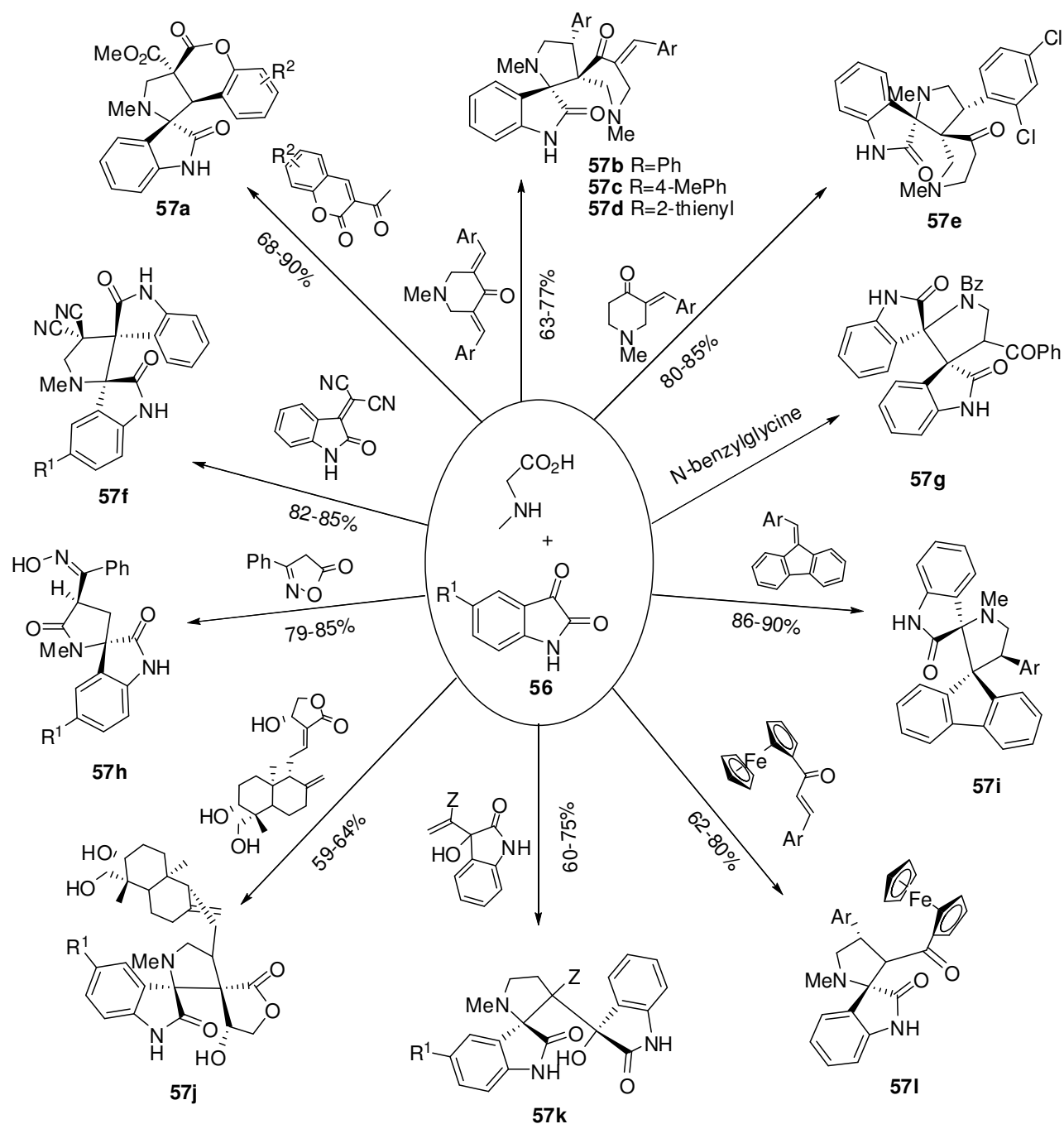

Scheme 13

Furthermore, it was reported that proline **58a** or 1,3-thiazolane-4-carboxylic acid **58b** react with isatines **56** in solution, under solvent-free microwave irradiation, ultrasonic irradiation, solid-phase, catalyzed or catalyst free conditions giving azomethine ylides by decarboxylative transamination at room or elevated temperature (Scheme 14).^{51,62-67}

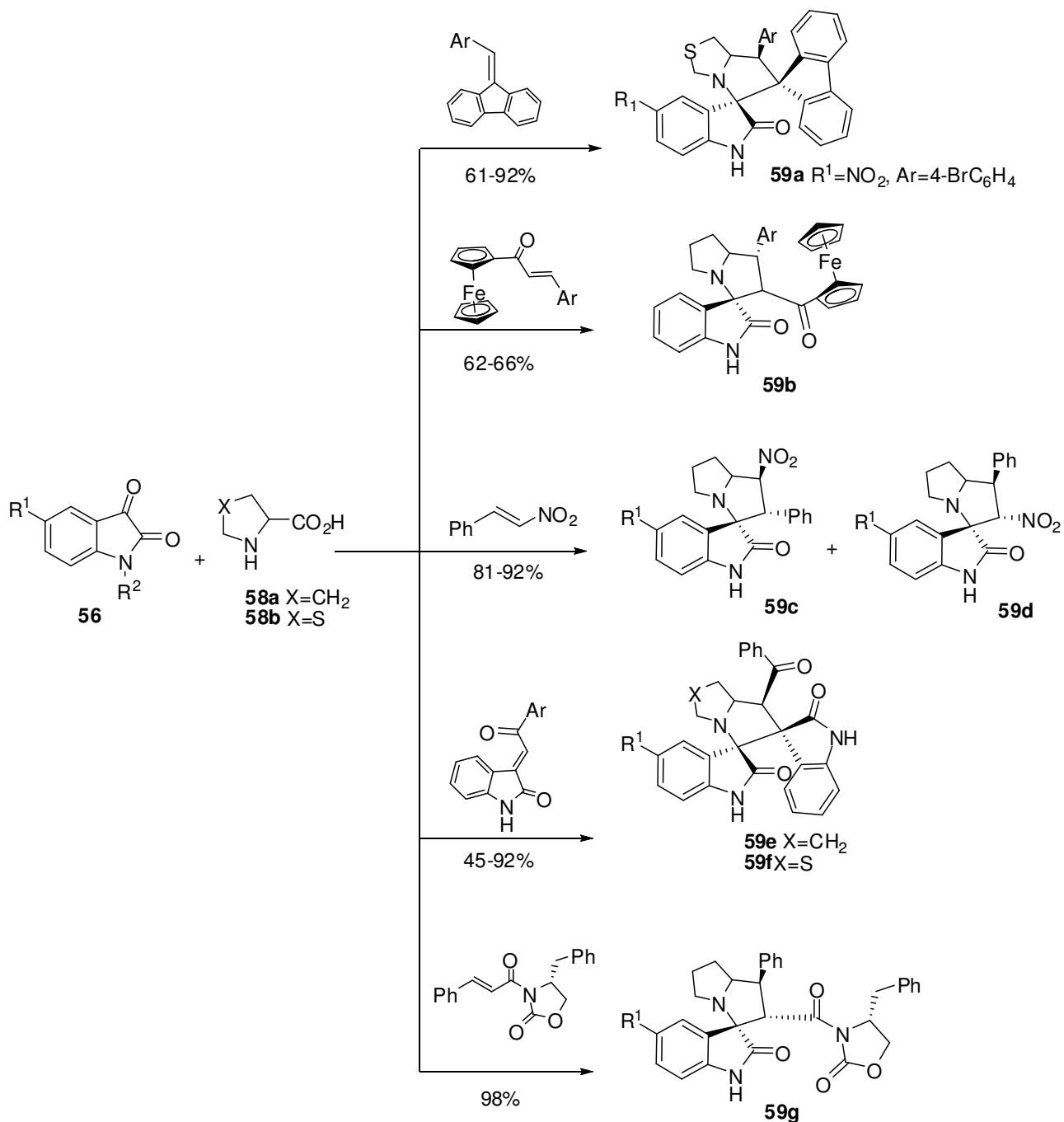

Scheme 14

Dispiro-oxindolylpyrrolothiazoline **59a**,⁶³ spiro-oxindole-pyrrolidone **59b**,⁶⁴ mixtures of nitro- or phenyl-hexahydrospiro[indoline-3,3'-pyrrolizin]-2-ones **59c,d**,⁶⁵ enantiomerically pure spirooxindoles **59e,f**⁶⁶ and diastereomeric pure compound **59g**⁶⁷ were obtained from the reaction of mentioned azomethine ylides with different dipolarophiles.

Thus, the [3+2] cycloaddition reaction of azomethine ylide **62** (generated *in situ* from isatin and sarcosine) with bromo-derivatives of Morita-Baylis-Hillman adducts **60** afforded highly functionalized bisoxindoles **63a-f**.⁶⁸

The phosphorus and sulfur ylides have been exploited for the synthesis of 3-spirocyclopentene **61a-d** and 3-spiropyrazole-2-oxindoles **61e-o** from *E*- and *Z*-isomers of bromo-derivatives of Morita-Baylis-Hillman adducts of isatin **60** with Me₂S/DEAD/K₂CO₃ and Ph₃P/activated alkene/K₂CO₃, respectively.⁶⁹

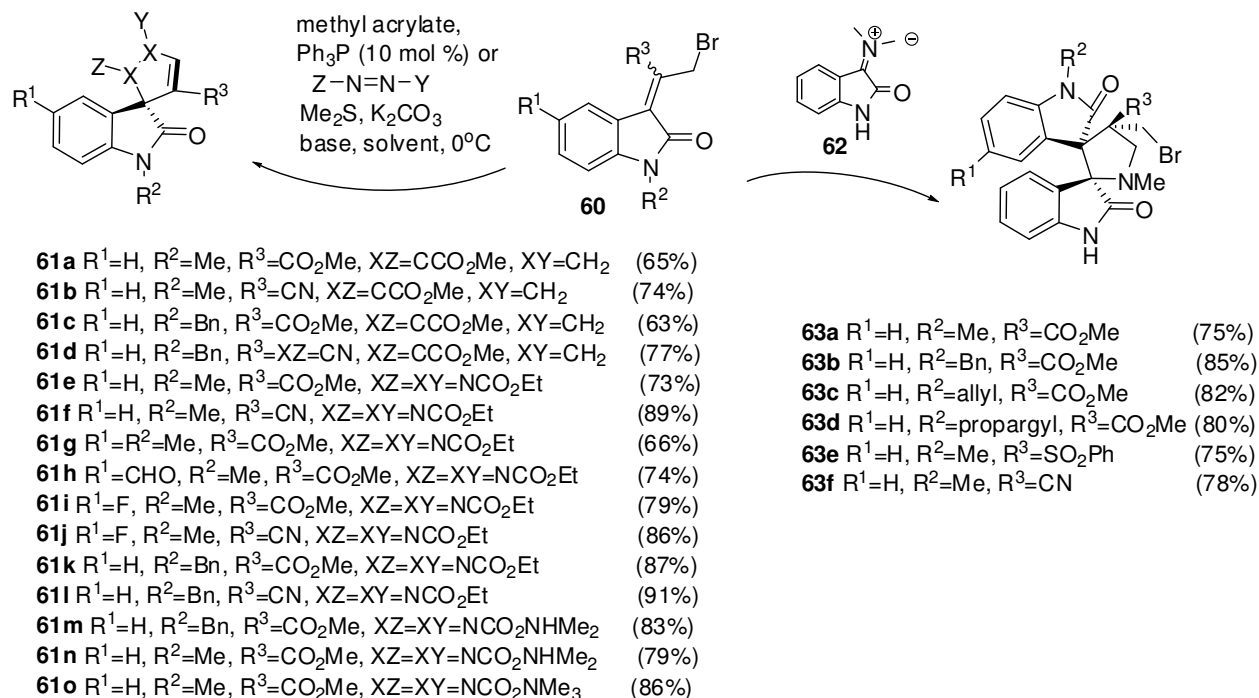

Scheme 15

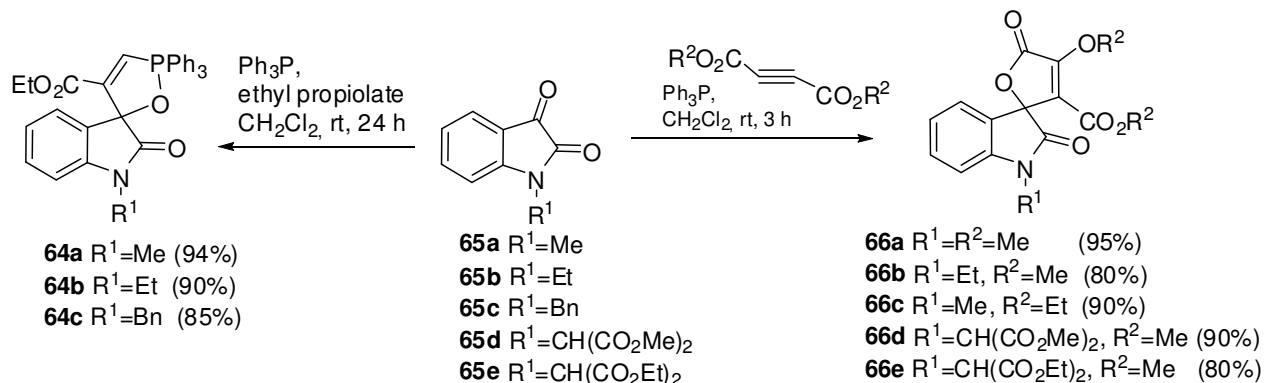

Scheme 16

The construction of spiranes depends on the selection of dipolarophiles. In general, the optimized studies revealed that the phosphine-catalyzed annulation reaction with allyl derivatives of oxindole was more sensitive towards solvents, temperature and substitution at the aryl ring. Reactions with diazo-compounds Z-N=N-Y afforded the corresponding spiro-pyrazole derivatives **61e-o** in good yields. Bromo-allyl derivatives with electron-withdrawing groups, such as formyl and fluorine, at the C5 position of the aromatic nuclei, resulted in a reduction of the reaction time with better yields compared to the electron-releasing

group, indicating that the [3+2] annulation reaction is favoured by electron-withdrawing groups **61h–j** in Scheme 15).⁷⁰ Another interesting point is that the formyl group was tolerant towards the [3+2] annulation reaction, providing spiro-pyrazole **61e–o** in good yields and no Huisgen zwitterions were involved in cyclic product at the formyl group.

The reaction of Ph_3P with ethyl propiolate or dimethyl (diethyl) acetylenedicarboxylate in the presence of *N*-alkylizatinins **65a–e** led to spiro-oxaphospholes **64a–c**⁷¹ or γ -spiro-lactones **66a–e**,⁷² respectively (see Scheme 16).

5.1.2. Metal catalysis

Spiropyrrolidinyloxindoles **70a–e** were synthesized in moderate yield *via* a diastereoselective Cu(I)-catalyzed three-component assembly reaction of an imine, diazocompound and dipolarophile **67b** (Scheme 17).⁷³

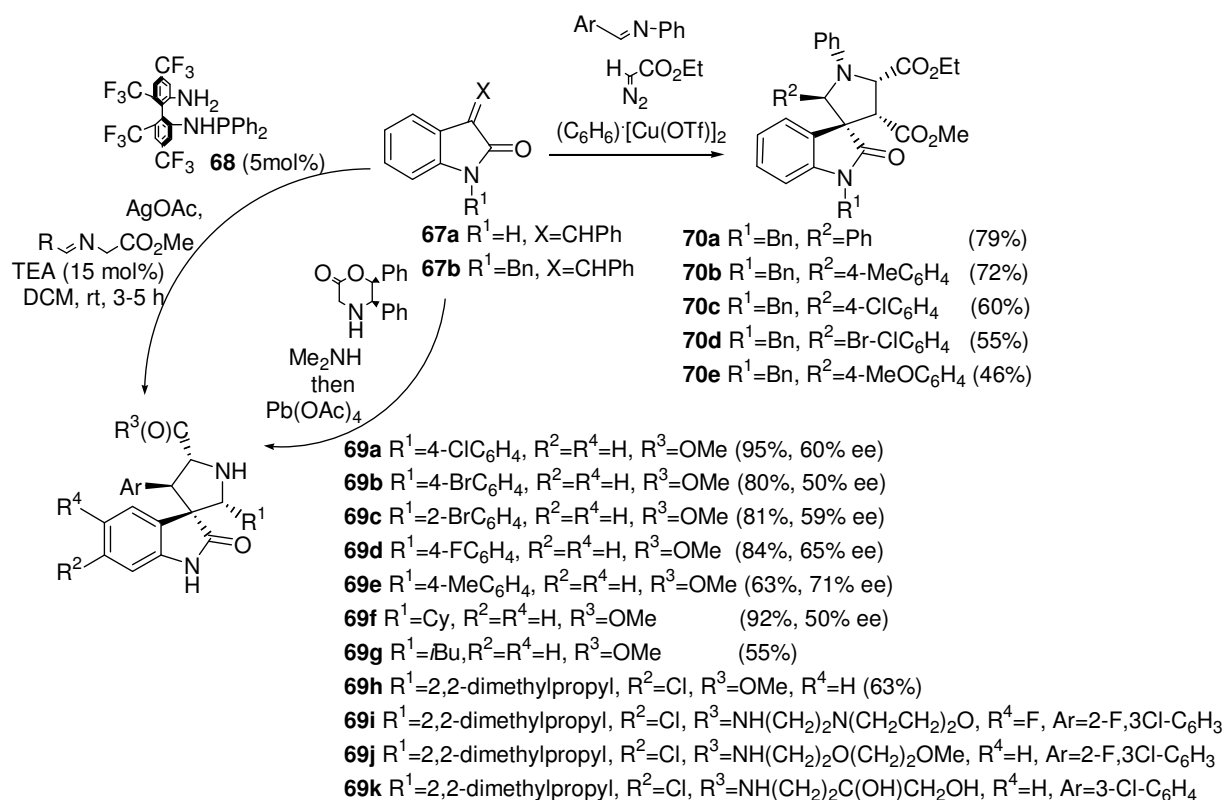

Scheme 17

Enantio-enriched spirooxindoles **69a–f** can be synthesized *via* catalyzed with TF-BiphamPhos **68**/AgOAc complex reaction of *N*-unprotected 2-oxoindolin-3-ylidene **67a** with glycine derivatives⁷⁴ (Scheme 17), while spiro[indole-3,3'-pyrrolidin]-2-ones **69g** and **69h** were also synthesized^{75–79} using asymmetric 1,3-dipolar cycloaddition as the key step. X-ray analysis of product **69h** revealed that in this case 1,3-dipolar cycloaddition showed different stereoselectivity from that previously reported.^{80–82}

Recently, catalyzed tandem construction of the C–O bond of spirooxindoles from isatins was reported.^{83–85} The synthesis of compounds **71a–h** containing both the oxindole and 6,8-dioxabicyclo[3.2.1]octane moieties with an aesthetically appealing spiro-bridge *via* catalyzed aldol reaction of 2-acetyl-6-methyl-2,3-dihydro-4*H*-pyran with various isatin derivatives **72a** is presented in Scheme 18.

It was reported that the titanium(IV) chloride-catalyzed cyclization of isatins **72a** with oxazoles affords spiro[3,3'-oxindoleoxazolines] **74a-f** as well. Substitution at the 4-position of the oxazole controls nucleophilic attack to provide the oxazoline spirocycle with regiocontrol.

On the other hand, a one-pot protocol for the synthesis of spiro-indolodioxolanes **73a-d** via rhodium(II) acetate-catalyzed reaction between diazoamide **72b** and aromatic aldehydes having electron-donating or -withdrawing groups involving construction of C-C and C-O bonds has also been described.⁸⁶

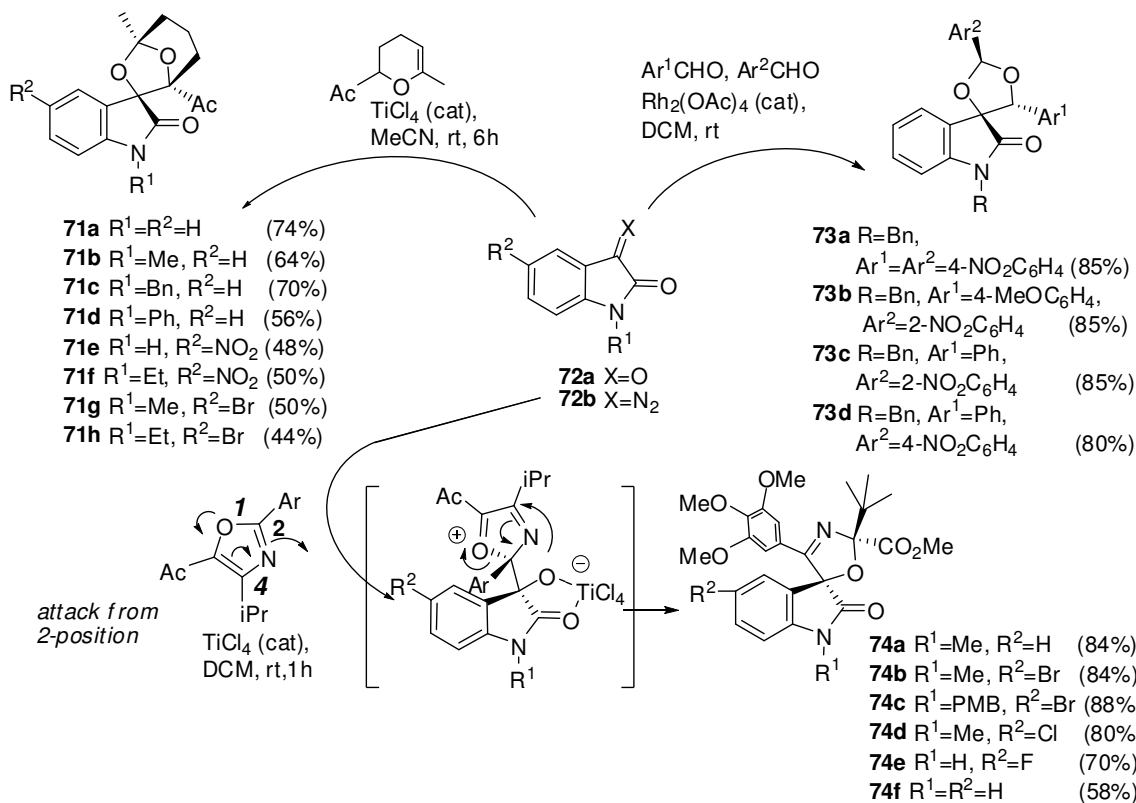

Scheme 18

Schreiber *et al.* developed a method for Lewis acid-mediated annulations of isatins **77a** using macrobead-bound crotylsilanes **78**, which gave spirocyclic products **79** as single stereoisomers (Scheme 19).⁸⁷ Use of 2,6-di-*tert*-butyl-4-methylpyridine (DTBMP) as a protic acid scavenger was essential to prevent Si-O deprotection or cleavage from the macrobead support. No protodesilylation or elimination of the silyl group was observed when HF/Py (5% in THF) was used to cleave the Si-O linker, demonstrating the complementary reactivity of the Si-O bond and the Si-C bond under these conditions.

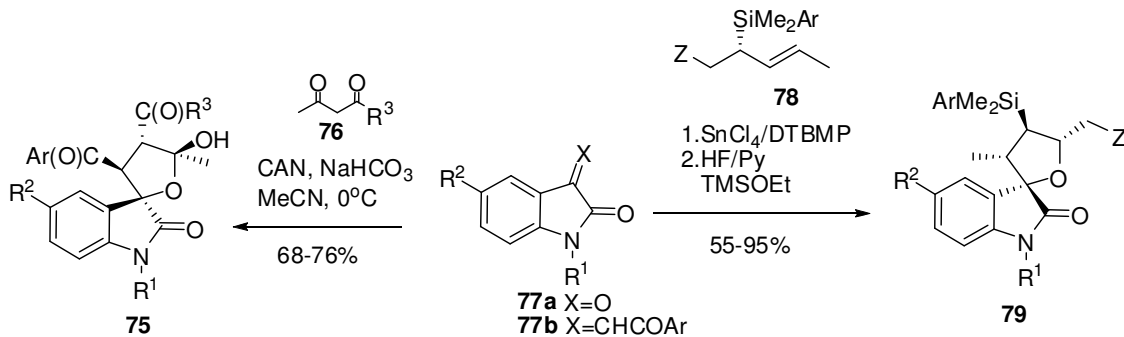

Scheme 19

Dihydrofuran-spirooxindoles **75** were prepared *via* a [3+2]-oxidative cycloaddition of 1,3-dicarbonyl compounds **76** to isatins **77b** mediated by ceric ammonium nitrate.⁸⁸ Various diastereomers were obtained in 1:1 ratios from different oxindole derivatives and 1,3-dicarbonyl compounds.

An approach to diversely functionalized spirocyclic oxindoles **81a–c** has been developed by using different metal-mediated carbonyl-addition/cyclization reaction sequences.^{89,90} Spirocyclization precursors **80** have been obtained by regioselective addition of stabilized organoindium reagents to isatins in aqueous environment. Pd-Cu bimetallic-catalyzed domino cyclization reactions of the above unsaturated alcohol derivatives provided oxaspirooxindoles **81a–c** (Scheme 20).

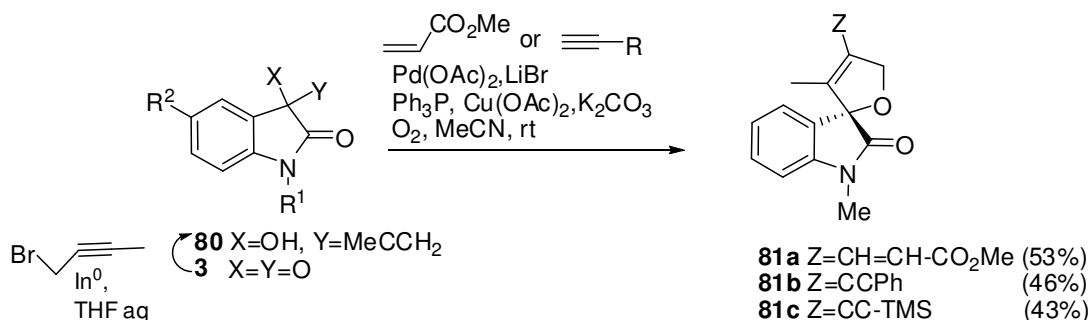

Scheme 20

5.1.3. Organocatalysis

Recently, an efficient one-pot procedure for the synthesis of enantiopure spiro[pyrrolidin-3,3-oxindole] derivatives **83** with four stereogenic centres by using BINOL-derived phosphoric acids **82** as catalyst has been developed (Scheme 21).⁹¹

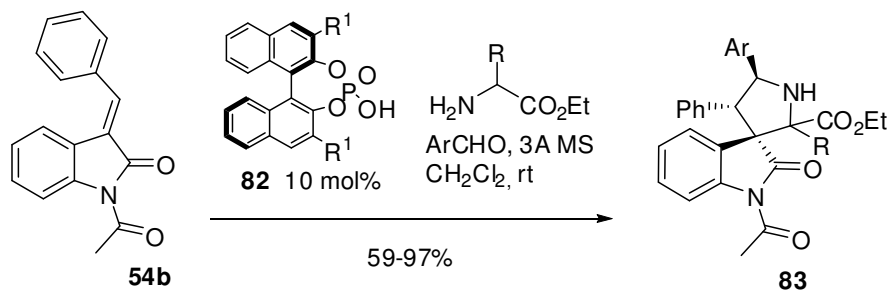

Scheme 21

The system displays great tolerance toward different aldehydes and amino esters. The products **83** are obtained in good yields and high enantio- and diastereoselectivities (from 81 up to 94 ee and dr 99:1).

An organocatalytic enantioselective approach for the construction of spirocyclic oxindolic cyclopentanes **86a–d** and **87a–d** has been based on the use of phosphines **85a,b** according to Scheme 22.⁹² It is worth noting that in all cases a mixture of isomeric products was isolated.

Asymmetric [3+2] cycloaddition reaction between methyleneindolinone **90c** and Morita-Baylis-Hillman carbonate leading to spirocyclopentaneoxindoles **93a–i** has been developed.⁹³ It provides high levels of enantioselective control involving a chiral phosphine (+)-Ph-BPE as a nucleophilic organocatalyst.

Nucleophilic heterocyclic carbene-catalyzed annulation of enals **88** and isatins **89a** afforded the mixture of γ -spirolactones **89** (Scheme 23).⁹⁴

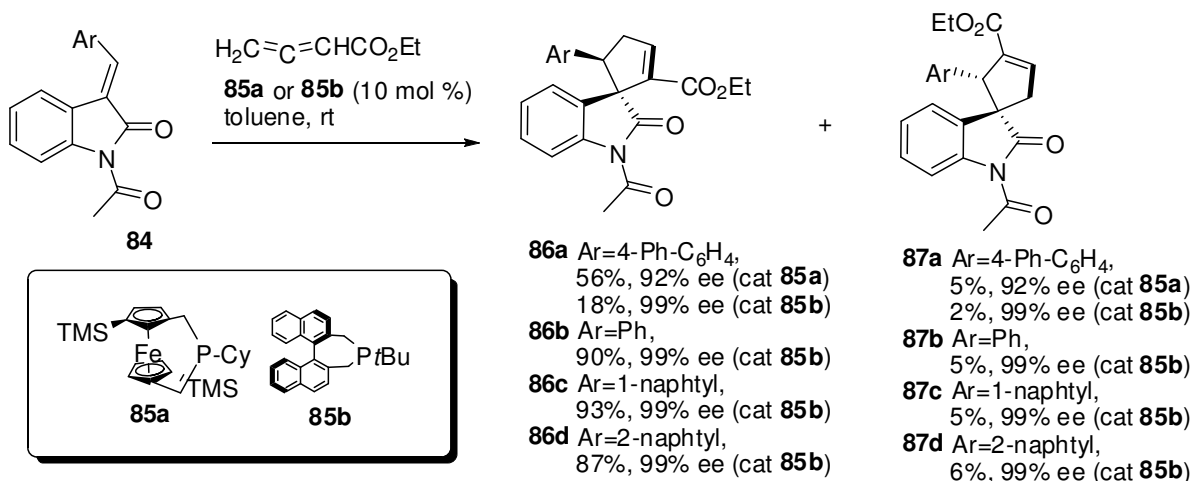

Scheme 22

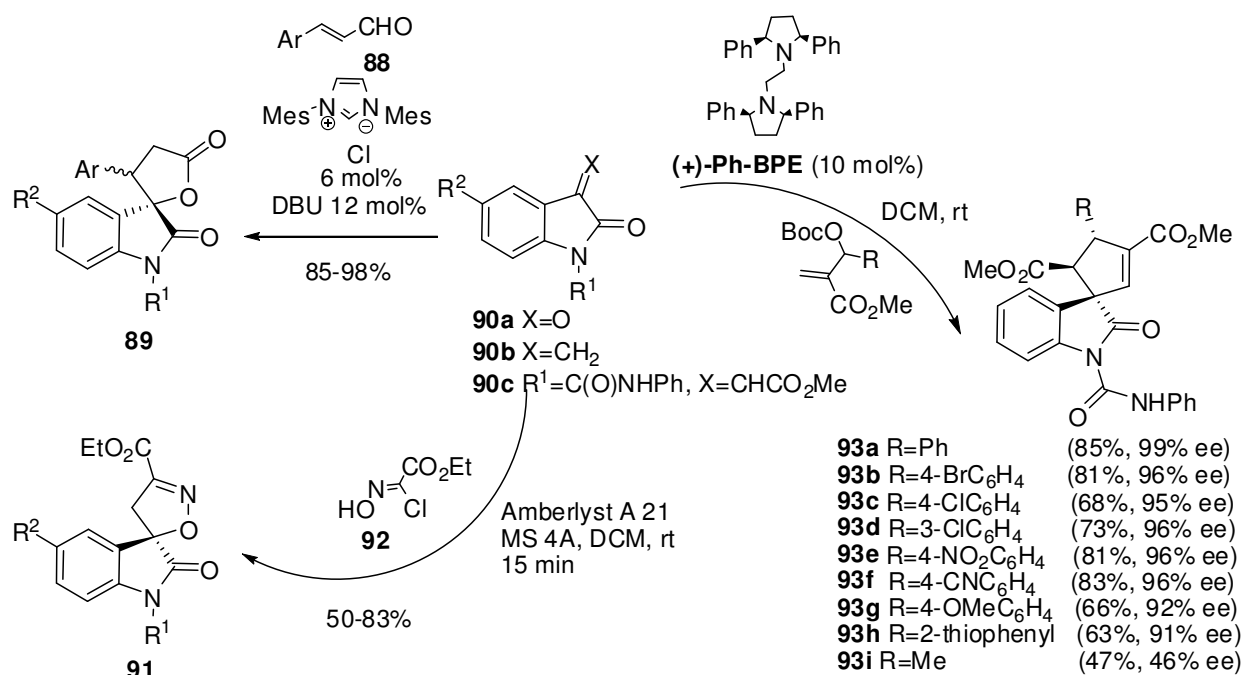

Scheme 23

Spiro-isoxazolines **91** can be obtained by cycloaddition of nitrile oxides (generated *in situ* from **92**) with 3-methylene oxindoles **90b**.⁹⁵ The rapid synthesis has been reported of optically active spiro[oxazoline-3,3'-oxindole]s **94** through the chiral thiourea **96**-catalyzed interaction of isothiocyanates **95** with isatins **97a** (Scheme 24).⁹⁶ The variation of the electronic properties of the substituent R², R³, R⁴ of the *N*-protected spiro[thiocarbamate-3,3'-oxindole] **94** with different steric parameters was tolerated, affording products with excellent enantioselectivities (91–99% ee) and diastereoselectivities in good to excellent yields (70–99%).

Direct catalytic asymmetric intermolecular aldol reaction of 3-isothiocyanato oxindoles **97b** with ketones using bifunctional thiourea-tertiary amine **98** as catalyst has been reported.⁹⁷ Such strategy provides an approach for the asymmetric synthesis of a variety of enantio-enriched spirocyclic oxindoles **99a,b**.

Condensation of the isatins **90a** with various anilines resulted in the formation of isatin-3-imines **97c** which underwent efficient cyclization in the presence of mercaptoacetic acid⁹⁸ (followed by oxidation of obtained sulfides with *meta*-chloroperbenzoic acid) or acetic acid to spirothiazolidinones **100**.⁹⁹

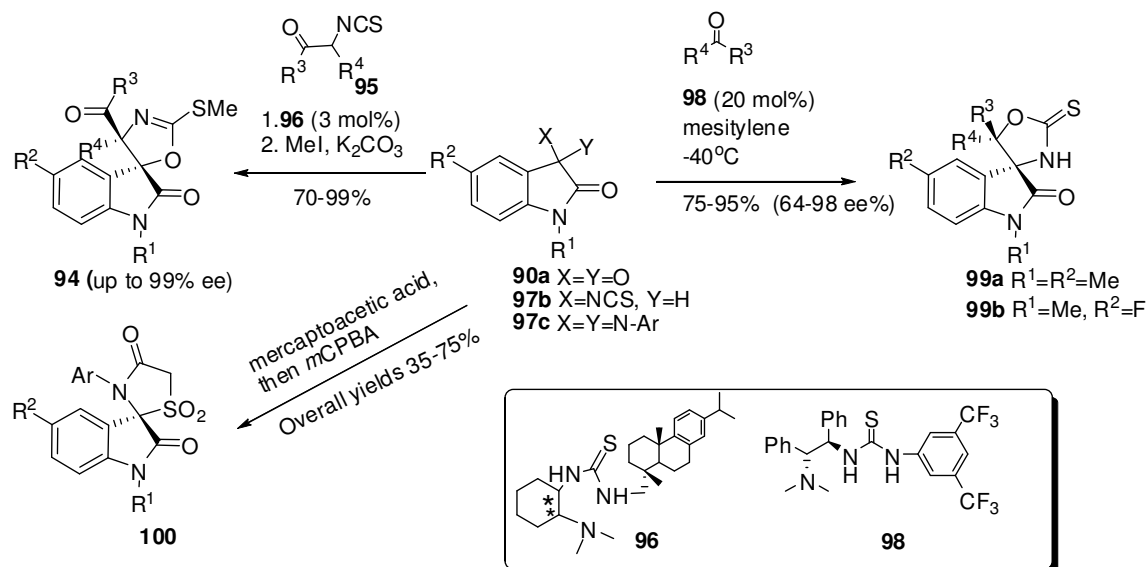

Scheme 24

Barbas *et al.* developed an efficient organocatalytic domino Michael-aldol approach for the direct construction of spirooxindoles **103a–l** from 3-substituted oxindoles **101** and methyleneindolinones **102** (Scheme 25).¹⁰⁰

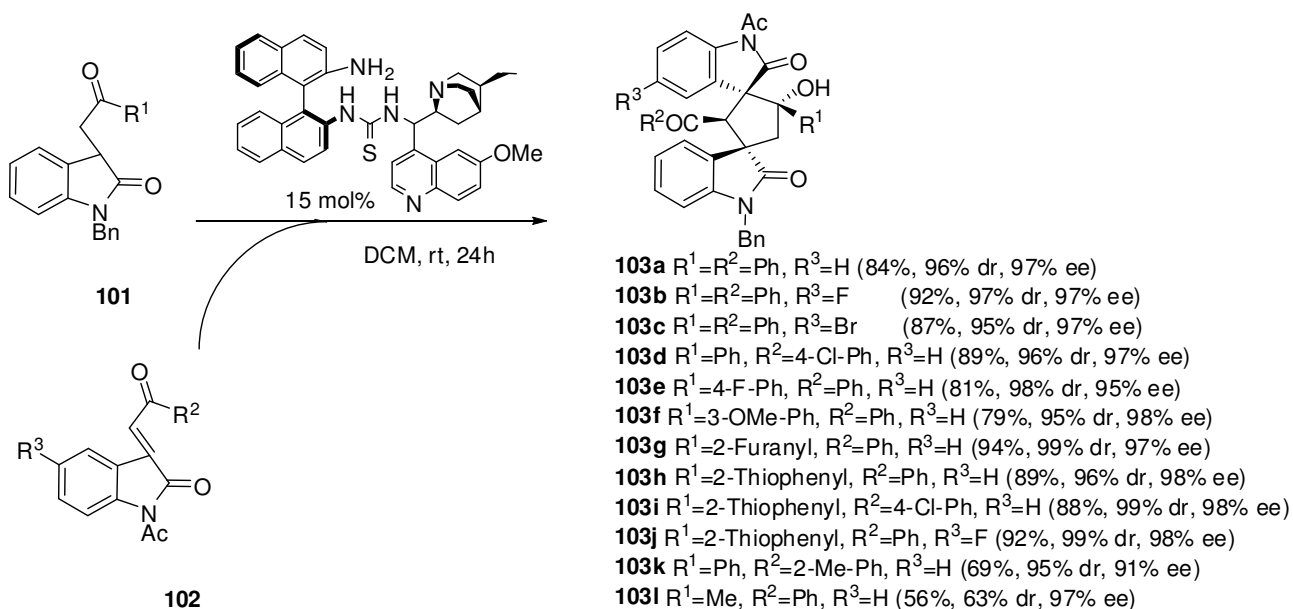

Scheme 25

Such a process, catalyzed by multifunctional cinchonine alkaloid containing a primary amine and axial chiral moiety, offers high stereo- and enantio-control (up to >99:1 d.r. and 98:2 e.r.).

5.1.4. Catalysts free

Photoreactions of 1-acetylisatin **104** with phenylacetylenes furnished a mixture of dispiroindole[3,2']furan[3',3'']indoles **105a–c** and **106a–c** (Scheme 26).¹⁰¹

The utility of bromo-derivatives of Morita-Baylis-Hillman adducts of isatin **60** for the synthesis of highly functionalized spiroindolizine oxindoles **107a–e** has been shown (Scheme 27).¹⁰²

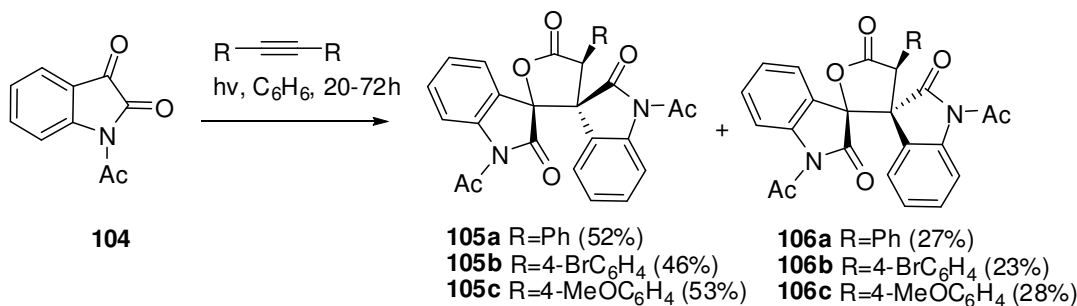

Scheme 26

It should be mentioned that a variety of substituted oxindoles **77b** with electron-donating or electron-withdrawing groups underwent smoothly cycloaddition by of NH₂NH₂ to afford spiroadducts **108** in good yield (Scheme 27).¹⁰³

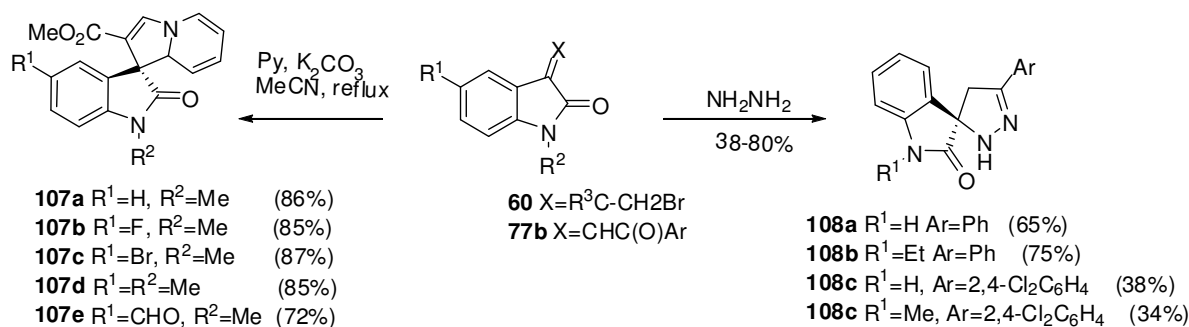

Scheme 27

5.2. Ring closing

Cadioux *et al.* from Xenon Pharmaceuticals Inc reported a development of a series of NaV1.7 blockers, starting from the oxindole **109**. Optimization and modification of compound **110** led to the target spirooxindole **111** (Scheme 28).¹⁰⁴

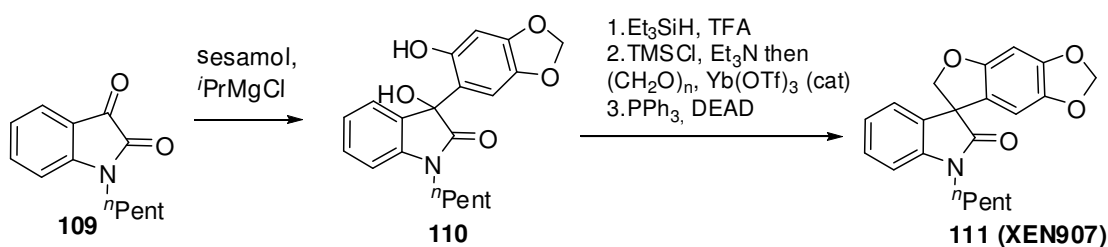

Scheme 28

It worth to note that the reaction involving **52** and 1,3-dibromopropane gives rise to a mixture of isomeric products having an m/z of 226 in a 3:2 ratio.⁴⁹ Analysis of the isomers by ¹H-NMR showed them to be the expected spirocyclopropyloxindoles **112**.

Condensation of the isatins **113a** with various thiosemicarbazone resulted in the formation of isatin-3-imines **113b** which underwent efficient cyclization in the presence of acetic anhydride to spirothiadiazoles **114a** and **114b** (Scheme 29).¹⁰⁵

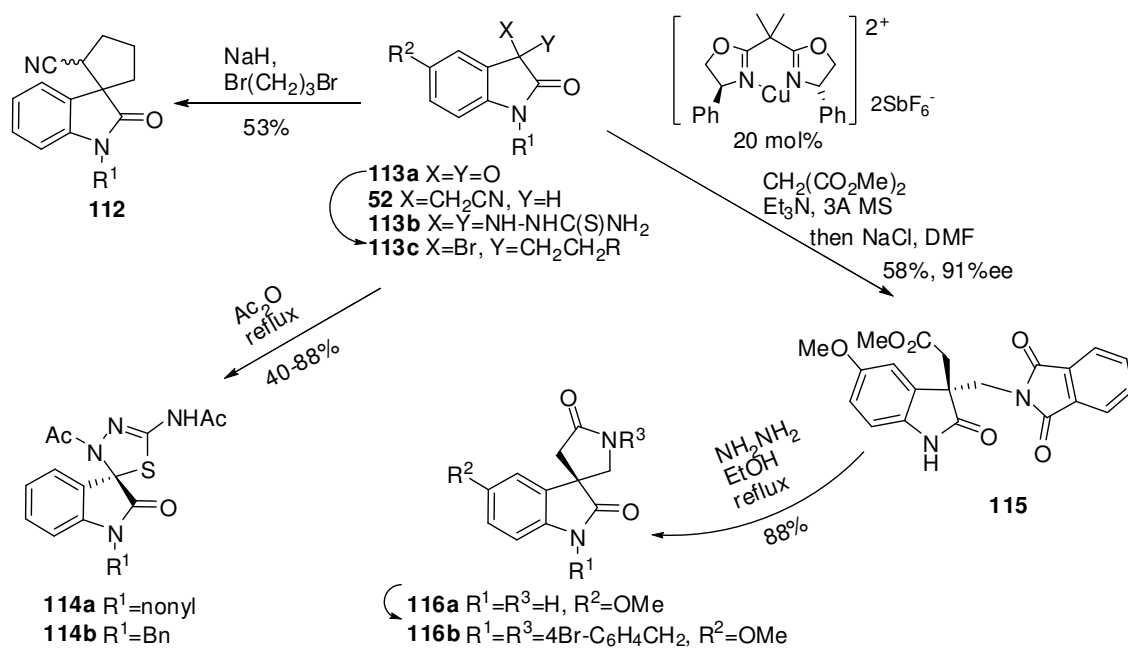

Scheme 29

The reaction of bromooxindole **113c** with dimethyl malonate proceeded smoothly to produce the C3-malonate adducts which was converted to phthalimidoester **115** by Krapcho decarboxylation in good yields.¹⁰⁶ Cleavage of phthalimide **115** with hydrazine resulted in rapid formation of spirocyclic bis(lactam) **116a**, double alkylation of which produced bis(*p*-bromobenzyl)lactam **116b**.

Recently, a synthesis was published of functionalized γ -butyrolactone-3-spirooxindoles **117a–h** using an organoindium reagent generated *in situ* from bromo-derivatives **60** and indium¹⁰⁷ or *via* the Morita-Baylis-Hillman adducts with trimethyl orthoformate, reaction with formaldehyde, followed by an acid-catalyzed lactonization (Scheme 30).⁷⁰

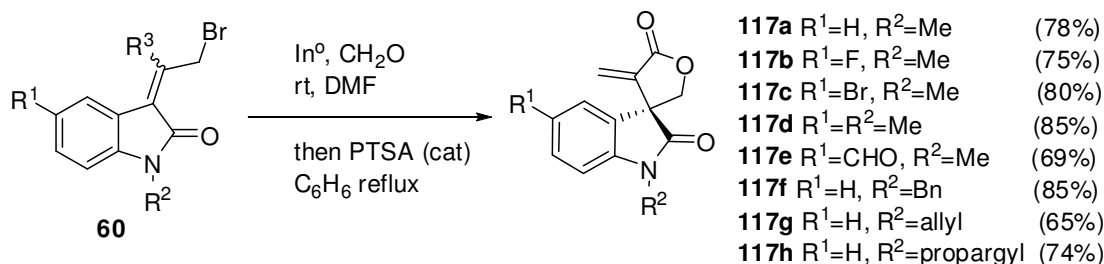

Scheme 30

5.3. Ring-expansion

It should be mentioned that Lewis acid-catalyzed ring expansion reactions of cyclopropyl spirooxindoles are widely used for preparation of five-membered derivatives.^{18,33,108–114}

α -Oxoketene dithioacetal **118** reacted with an equimolar amount of aziridine in THF at room temperature (10 hours) to afford the corresponding 3-[(*N*-aziridinomethylthio)-methylene]oxindoles **119** in 65% yield.¹⁰⁸ Compounds **119** reacted with potassium iodide in acetone at room temperature under nitrogen atmosphere and work-up of the reaction mixture furnished a 2-oxospiro-(3*H*-indole-3,3'-1'-pyrrolines) **120** (66–70%). The treatment of **120** (R²=H) with Nickel Raney (W2) in refluxing methanol (8 hours) gave a

single product which was found to be the desired known (\pm)-coerulescine **4** obtained in 80% yield.¹⁰⁹ Reductive methylation of **120** ($R^2=OMe$) with either sodium cyanoborohydride/HCHO or with HCHO/HCO₂H also afforded the well known (\pm)-horsfiline **5** in 55% and 30% yields, respectively (Scheme 31).¹¹⁰

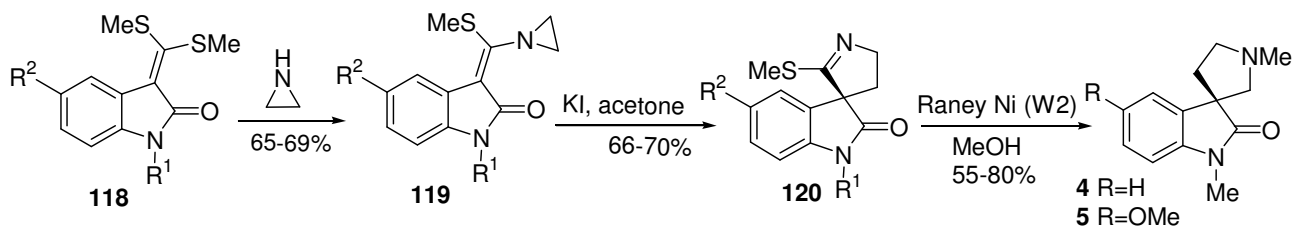

Scheme 31

Carreira *et al.* have described a synthetic route for preparation of strychnofoline **10** as well as spirotryprostatin B **122**.^{33,112} This transformation demonstrates the ability to carry out such annulation reactions with vinyl-substituted cyclopropanes **123a,b** and a synthetically versatile alkynyl imine (Scheme 32).

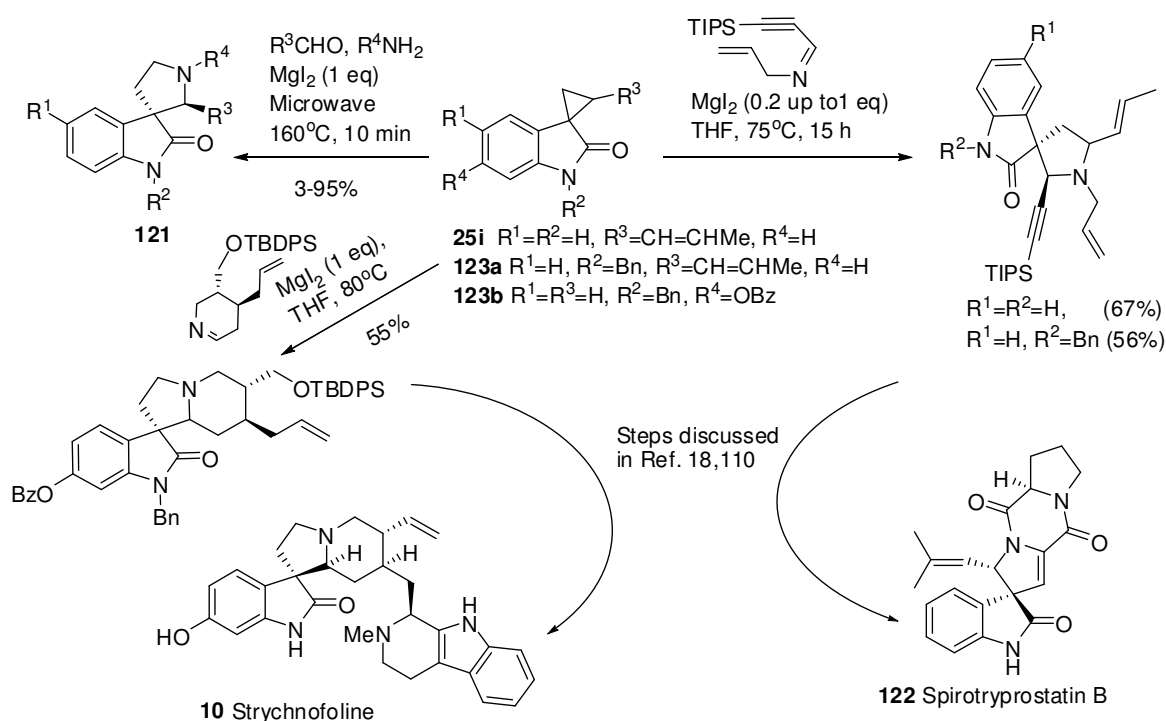

Scheme 32

The microwave-assisted synthesis of 3,3-pyrrolidinyl-spirooxindole cores **121** from cyclopropyl spirooxindoles and aldehydes, amines and sulfonamides was recently reported.¹¹¹ This reaction was fairly general and tolerated aliphatic and aromatic aldehydes, although the latter were preferred due to their availability. As amine component, aniline, alkyl amine or sulfonamide was used. In case of aniline and alkylamine, yield of reaction was better (37–95% and 3–53%, correspondently) than with sulfonamide (0% up to 68%). It should be mentioned that reaction of aryl aldehyde with aniline (Scheme 32) was the most stereoselective and had the best yield.

The structural complexities of spirocyclic five-membered compounds have challenged synthetic chemists to develop ever more clever strategies for their synthesis. We have demonstrated a number of successful applications of isatins in the fields of five-membered spirocyclic natural and non-natural oxindoles

synthesis including enantio-enriched ones. In parallel to the search for above-mentioned spiranes, there is currently much interest in the development of six-membered spirocyclic oxindole. The next part of this review covers the most recent applications of isatins in the synthesis of six-membered spirocyclic oxindoles.

6. Six-membered spirooxindoles

6.1. Cycloaddition

6.1.1. Lewis base or acid catalysts

Recently the synthesis of spirooxindole **126** starting from 3-chloromethylene-2-indolone **124** and 2-trimethylsilyloxybutadiene was reported (Scheme 33).¹¹⁵

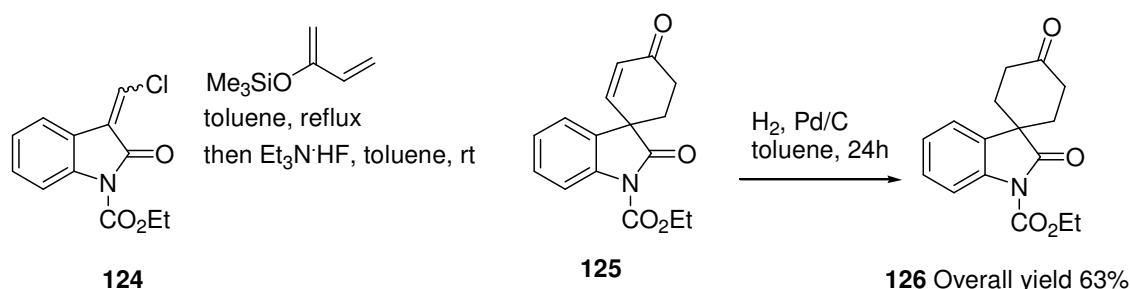

Scheme 33

The reactions were performed on a multi-gram scale, without isolation of the intermediates, by reacting an excess of diene in toluene at reflux. After 3 hours the crude reaction mixture was treated with triethylamine hydrogen fluoride (1 equiv) for 2 hours at room temperature to give the unsaturated ketone **125**. The reduction of enone **125** with hydrogen and Pd/C at room temperature afforded spirooxindole **126**.

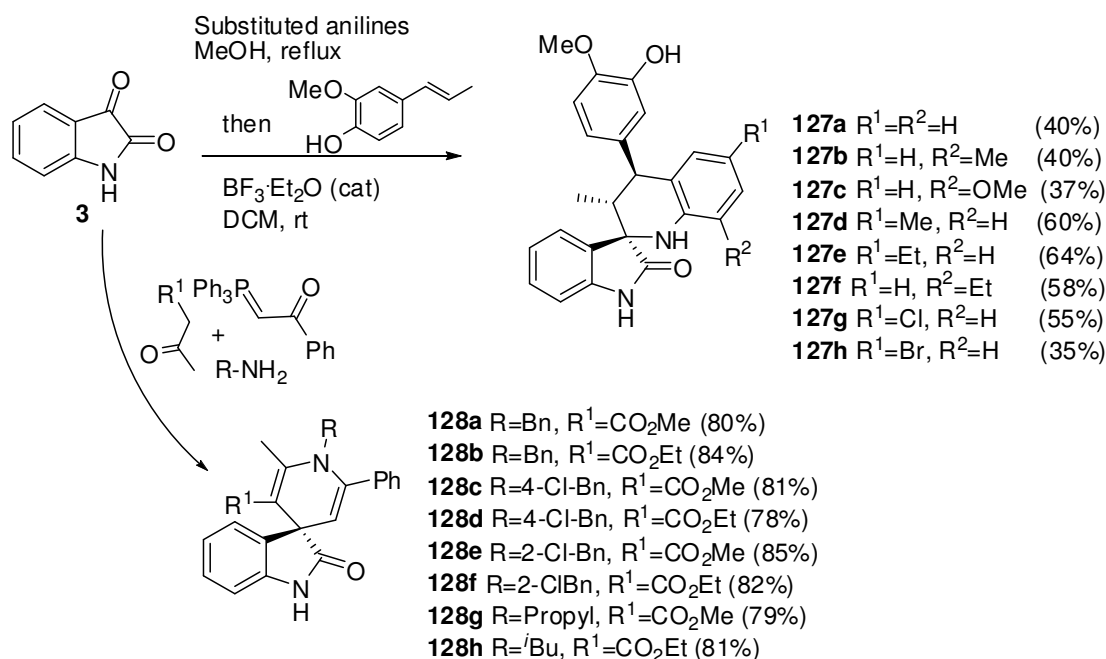

Scheme 34

The two-step synthesis of spiro[indoline-3,2'-quinolin]-2-ones **127a–h** through Lewis acid $\text{BF}_3 \cdot \text{Et}_2\text{O}$ -catalyzed cycloadditions between ketimines of isatin and aromatic anilines and *trans*-isoeugenol was presented by Kouznetsov *et al.* (Scheme 34).¹¹⁶ The overall yields of spirocoupled systems **127a–h** were moderate.

The synthesis of spiro[indoline-3,4'-pyridine]-3'-carboxylates **128a–h** involves reaction of isatins **3**, 1-phenyl-2-(1,1,1-triphenyl- λ^5 -phosphanylidene)-1-ethanone and benzylamine derivatives or aliphatic amines, in the presence of alkyl acetoacetate.¹¹⁷ Different solvents, such as MeOH, EtOH, MeCN, THF and DCM were explored. The best results with high yield products were obtained by refluxing the reaction mixture in MeOH. It was observed that the nature of the aryl substituent in the benzylamines had no significant effect on the final yield of the products. Moreover, it was found that the reaction with 1-phenylpropan-2-one did not occur.

6.1.2. Organocatalysis

The tandem reaction for the asymmetric synthesis of six-membered spirocyclic oxindoles has been developed through a [2+2+2] annulation strategy (see Scheme 35).^{118,119}

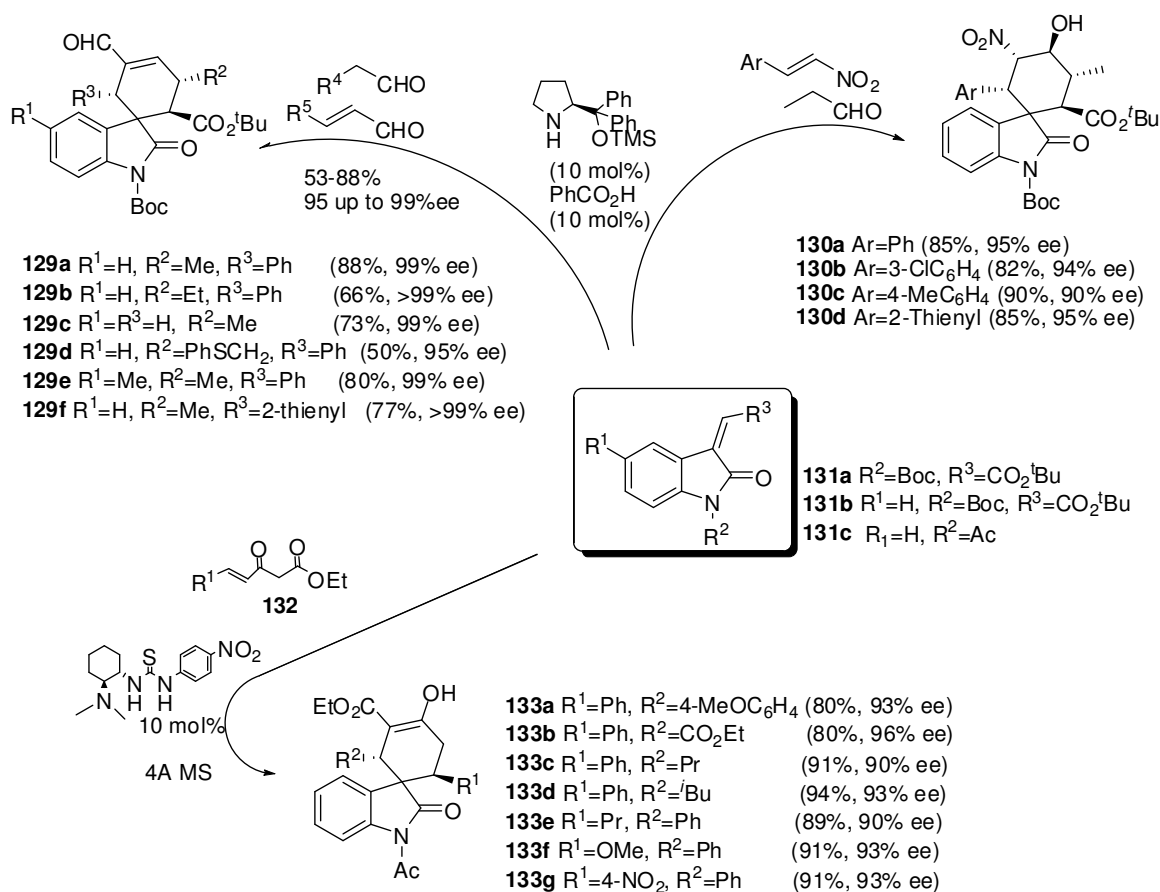

Scheme 35

The proline derivative amine-catalyzed stereoselective Michael addition of aliphatic aldehydes to electron-deficient olefinic oxindoles **131a,b** gave chiral C3 components, which were further combined with diverse electrophiles to afford spirocyclic oxindoles **129** and **130**. A slower reaction was observed when acetic acid was used as the additive. The reaction became quite sluggish in the absence of benzoic acid. The aldol adducts **130** were isolated as the major products. Different olefinic oxindoles **131a** were explored. The

electronic features of the substituents on the aryl ring had little effect on the reactivity and good results were obtained. Nevertheless, the olefinic oxindole with β -phenyl group exhibited much lower reactivity, and slightly harsher reaction conditions were required.

Spiro[cyclohexane-1,3'-indoline]-2',4-dione derivatives **133a–g** have been synthesized *via* a Lewis base bifunctional thiourea-catalyzed [4+2] cycloaddition reaction.¹²⁰ A wide range of 3-aryl-methylene-indolinones **131c** were reacted with Nazarov reagents **132** on the action of chiral thiourea. Basically, the reaction proceeded smoothly to give desired product in high yields. The electronic characteristic of the aryl substituent has little effect on the enantioselectivity. As a result, different enones were utilized in the cyclization reactions with excellent enantioselectivity ranging from 90 to 96% ee (compounds **133a–g**). On the other hand, the diastereoselection was sensitive to electronic property of the substituent and benefited from the electron donating feature. For example, a very high diastereomeric ratio of 98/2 was observed for (*E*)-1-acetyl-3-(4-methoxybenzylidene)indolinone, whereas (*E*)-methyl 4-[(1-acetyl-2-oxindolin-3-ylidene)methyl]benzoate gave only 90/10 dr. It should be noted that the methyleneindolinones having a much electron-deficient carbon-carbon double bond are much more reactive toward the Nazarov reagents and thus achieved clean cyclization reactions at $-30\text{ }^{\circ}\text{C}$ with high enantioselectivity (96–97% ee). More significantly, 3-alkyl methyleneindolinones could be accommodated in the reaction in high yields and good enantio-selectivity.

Spiropyran-oxindoles are promising candidates for chemical biology and drug discovery. The synthesis of the optically active spirooxindoles **137a–c** was recently reported. As catalysts, cupreine **136a**, cinchonidine **136b**, cinchonine **136c** or brevicolline **139d** were used (Scheme 36).^{121,122} Spirooxindoles **137a–c** were obtained in excellent yields (up to 99%) with good to excellent enantioselectivities (up to 97%) from simple and readily available starting materials (isatins **3**, **134**, acetylacetone **135a**, ethyl 3-oxobutanoate **135b** and malononitrile) under mild reaction conditions.

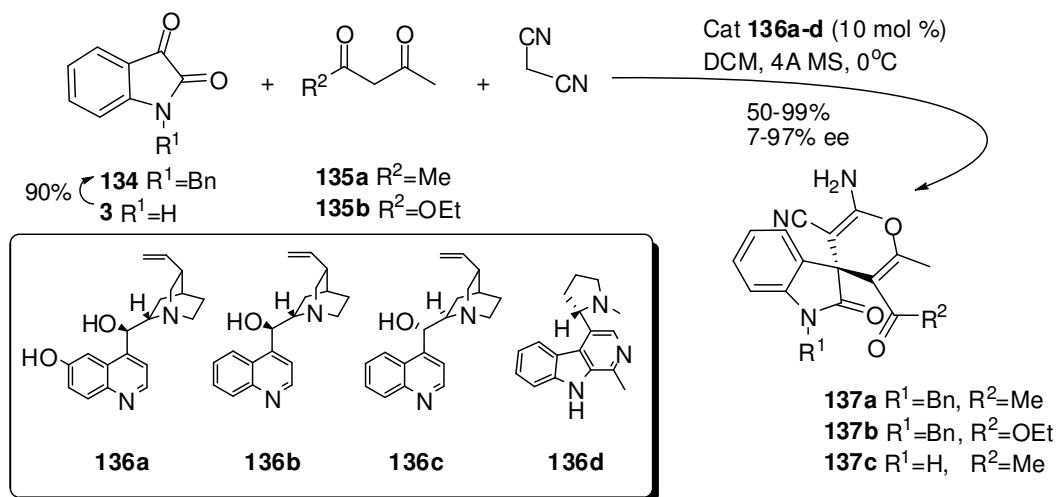

Scheme 36

6.2. Ring closing

The hydroindane-spirooxindoles **139a–i** were synthesized *via* a three-component domino reaction of (*E*)-4-(1-methyl-2-oxindolin-3-ylidene)-3-oxobutanoates **138** and two molecules of α,β -unsaturated aldehydes under quadruple iminium-enamine-iminium-enamine catalysis (Scheme 37).¹²³

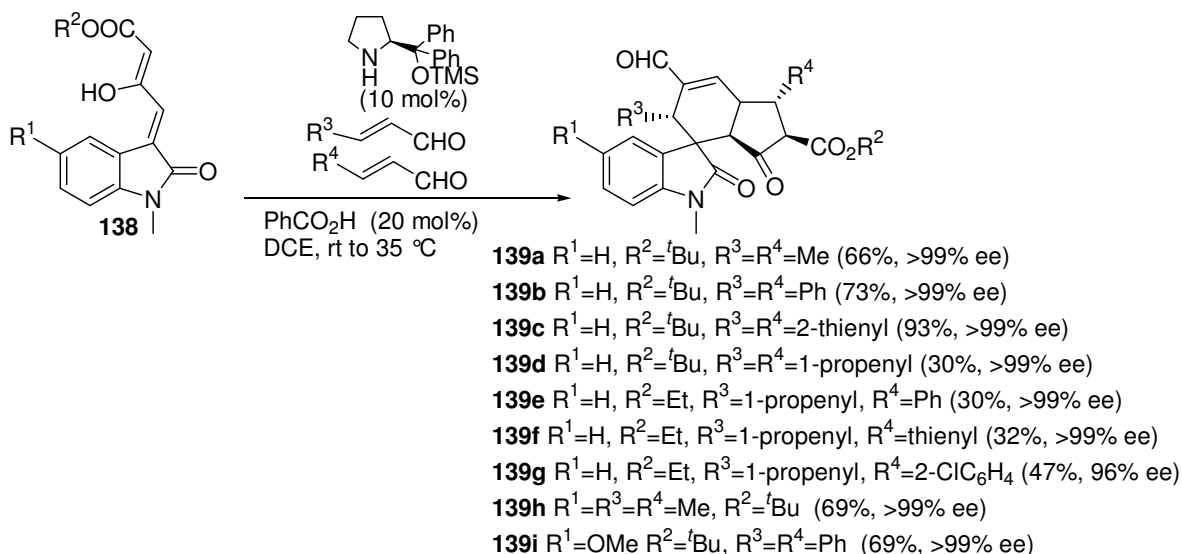

Scheme 37

It was reported that mixing 20 mol% of TfOH, 1 equiv of isatin diketal **140** and 1.5 equiv of dioxinone **141**, afforded the products **143a–f** in high yields and levels of diastereoselectivity favouring the 2,6-*cis*-isomer (Scheme 38).¹²⁴

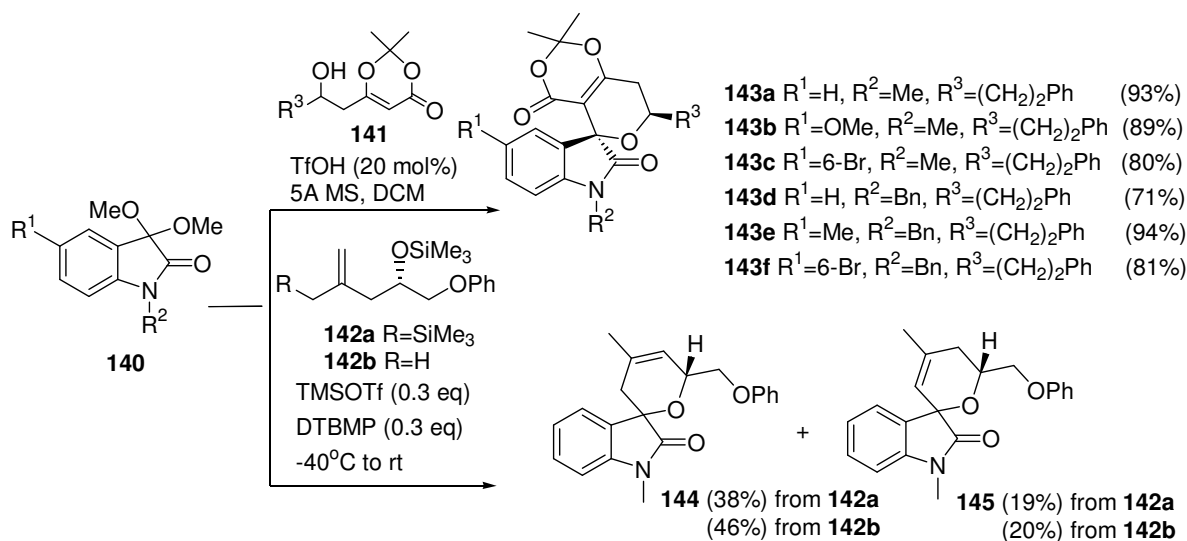

Scheme 38

Wang *et al.*¹²⁴ noted that addition of flame-dried 5A molecular sieves to the reaction mixture was crucial to achieve the high yields for this process. Moreover, it was found that both electron-donating and withdrawing substituents are tolerated at either 5 or 6 positions when the nitrogen of the isatin was protected with a methyl or benzyl group. In addition, the unprotected isatin substrate was compatible with the reaction conditions, but no reaction was observed with more sterically demanding substrates, such as 4-bromoisatin.

Porco *et al.* reported the synthesis of spirocyclic pyranes **144a,b** and **145a,b** using Prins cyclizations of homoallylic alcohols **142a,b** and isatin ketal **140**.¹²⁵ Homoallylic silyl ether **142a** was employed in the reaction to afford products **144** and **145** in reasonable overall yield. Intramolecular cyclization of homoallylic silyl ether **142b** derived from desilylation of **142a** gave the same mixture of oxaspiro-products **144** and **145**.

On the other hand, the camphor-10-sulfonic acid (CSA)-catalyzed domino reactions afforded the spiro[indoline/acenaphthylene-3,4'-pyrazolo[3,4-*b*]pyridine derivatives **146a–h** (Scheme 39).^{126,127} These processes take place in water and involve the generation of two rings and five new bonds (two C–C, two C–N and one C=N) in a one-pot synthetic process.

Pseudo four-component synthesis of spiro[diindenopyridine-indoline]triones *via* the reaction of 1,3-indandione, aromatic amines and isatins using a ‘Grindstone Chemistry’ method is also reported.¹²⁸ This approach was evaluated using four substituted isatins, five substituted anilines and 1,3-indanedione. The corresponding spirooxindoles **149a–h** were obtained in good yields under similar conditions. The results were good in terms of yields and products purity in the presence of *p*-TSA, while without *p*-TSA, yields were low (<40%) even after 30 minutes. However, when reaction was carried out with aliphatic amines, such as *n*-propylamine or ethylamine under the same conditions, the yield of the target product was very low.

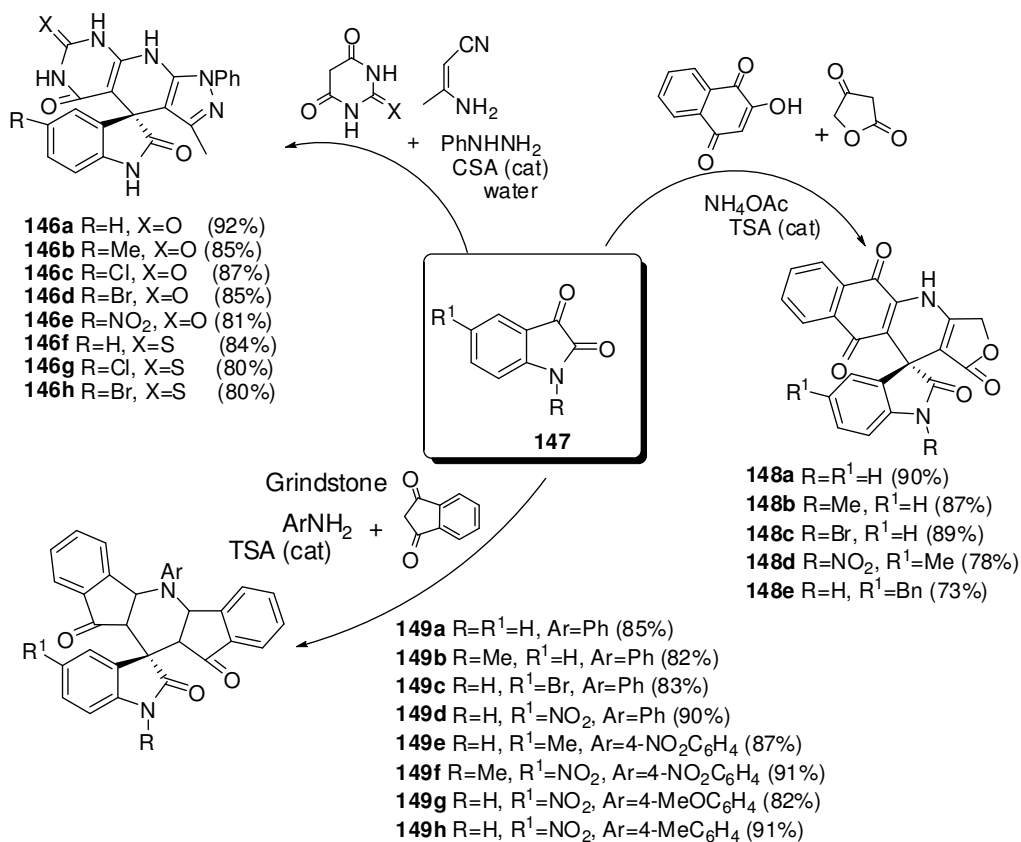

Scheme 39

Multi-component methods have been developed for the synthesis of spirooxindoles **148a–e** from isatins **147**, furan-2,4(3H,5H)-dione, 2-hydroxy-1,4-naphthoquinone and ammonium acetate, in the presence of a catalytic amount of *p*-TSA under ultrasound irradiation.¹²⁹ To search for the optimal reaction solvent, different solvents such as H₂O, CH₂Cl₂, MeCN and EtOH at 50 °C under ultrasonic irradiation were used. The reaction using ethanol as solvent resulted in higher yields and short reaction time. It was found that increasing the amount of catalyst from 10 to 20 and 30 mol% led to increase of the yields up to 71 to 90 and 91%, respectively.

Padwa *et al.*¹³⁰ have demonstrated the utility of the quasiaromatic 2*H*-indol-2-one system **155a–d** for the synthesis of spirooxindoles (Scheme 40). They found that 3-hydroxy-3-(3-phenylpropyl)indolin-2-

one **155a** could be converted into spirooxindole **150** in 76% yield upon heating with $\text{BF}_3 \cdot \text{OEt}_2$ in DCM at reflux. A related acid-catalyzed cyclization with 3-hydroxy-3-pent-4-enyl-1,3-dihydroindole-2-one also proceeded under similar conditions. It is worth noting that a single cyclized product **151** was obtained in 80% isolated yield. The product **152** was also formed from the acid-catalyzed reaction of the corresponding methyl ether **155b**. The reaction of (4-methylpent-4-enyl)indolone with $\text{BF}_3 \cdot \text{OEt}_2$ did not produce the expected spirocyclic oxindoles **153a,b**, giving instead the cyclic tetrahydro-2*H*-pyran **152** in 81% yield as an exclusive product. However, if (4-methylpent-4-enyl)indolone is first converted into the corresponding acetate **155c**, the spiro-substituted oxindole **153a,b** is indeed formed (65%). In this case, a 2.5:1 mixture of regioisomeric alkenes is produced.

SmI_2 has been used to cleave a sulfur linker and trigger cyclizations in strategies for the synthesis of *N*-heterocycles.¹³¹ It was observed that treatment of **155d** with SmI_2 gave unusual spirocyclic sulfones **154a** and **154b** in 62% and 40% yields, respectively.

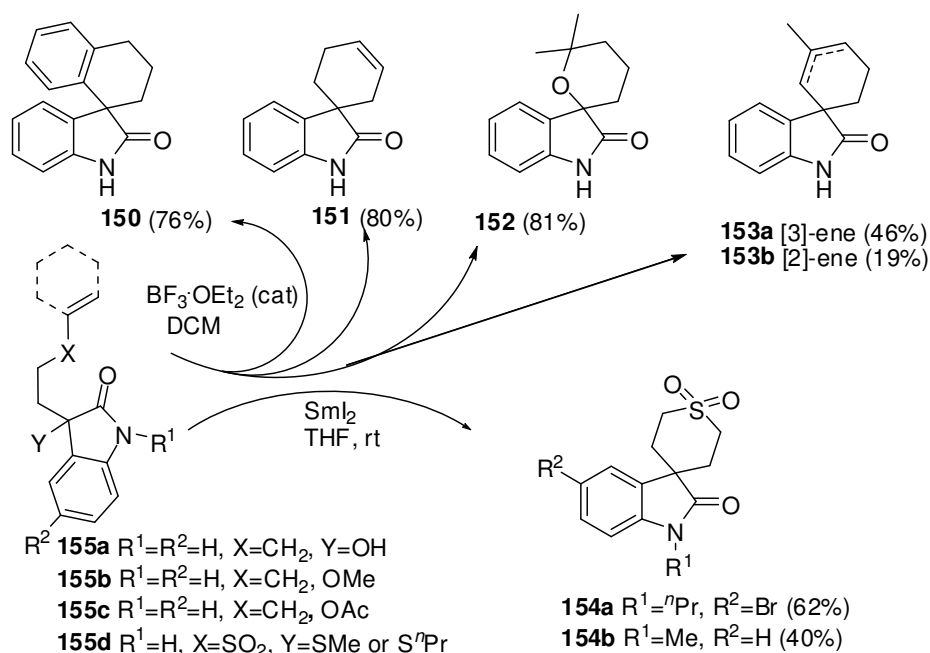

Scheme 40

In conclusion, the use of isatins for the construction of six-membered spirooxindoles can provide practical methods for the preparation of such compounds. The reactions are highly regioselective, often stereoselective and permit the synthesis of a variety of cyclic systems, both saturated and unsaturated. The substrates employed in most cases are simple (and often commercially available) making the methods amenable for the rapid construction of diverse collections of compounds.

7. Seven-membered spirooxindoles

The synthesis of enantiopure oxo-azepinoindolinone **161** was performed starting from the symmetric spiro[cyclohexane-1,30-indoline]-20,4-diones **157** (Scheme 41).^{130,132}

The initial step has included formation of azepino ring of stereoisomers **158** and **159**. The deprotection of the nitrogen atom of the azepino ring **158** was first performed by oxidizing the hydroxy group of the chain with PCC to give the ketone **160** (96%), which was then treated with NaH in THF at 65 °C for 3 hours.

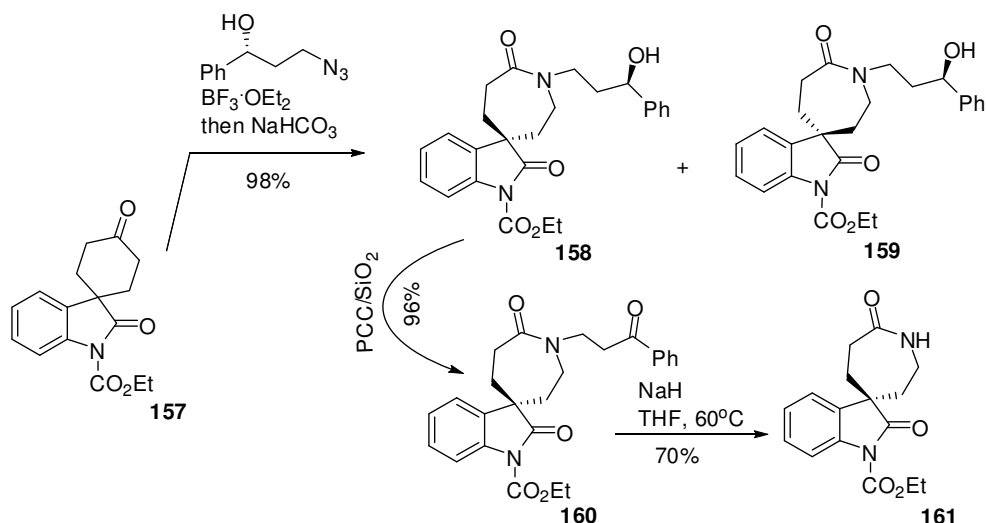

Scheme 41

Earlier the protocol for accessing functionalized seven-membered oxaspirooxindoles with high diastereoselectivity by BF₃·OEt₂ promoted [5+2] annulation of chiral crotylsilanes was described (Scheme 42).¹³²

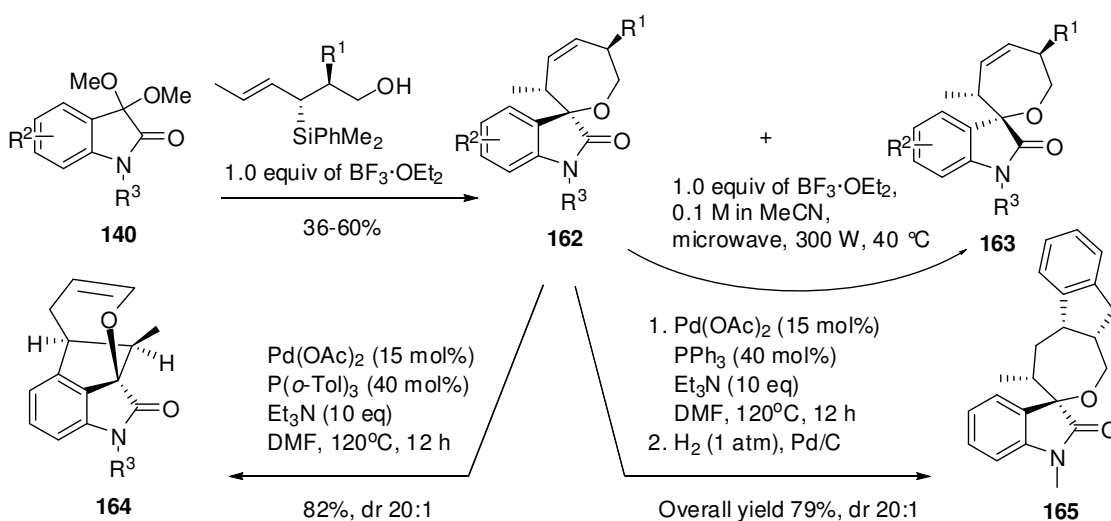

Scheme 42

The spirooxindoles can be enhanced by employing different combinations of functionalized silyl alcohols or substituted isatin reaction partners. The [5+2] annulation strategy nicely expands the scope of the Prins cyclization in the construction of highly functionalized spirocyclic oxindoles **162** and **163**. Additionally, *cis*-isomer **162** can be converted into *trans*-isomer **163** under BF₃·OEt₂ promoted conditions. Products **162** were further converted into fused polycyclic ring systems **164** and **165** utilizing intramolecular Heck cyclization.

8. Biological activity of discussed spirocyclic oxindoles

In recent years, an increasing problem in the treatment of AIDS patients has arisen due to resistance and cross-resistance to all marketed reverse transcriptase inhibitors.¹³³⁻¹³⁸ Reverse transcriptase (RT) inhibitors play a major role in the therapy of human immunodeficiency virus type 1 (HIV-1) infection. Highly active antiretroviral therapy (HAART) is the standard of care for AIDS patients. The majority of

HIV-infected individuals are currently taking reverse transcriptase inhibitors as a critical part of HAART. However, during the long-term therapy, resistance to chemotherapy can be developed in a significant number of patients. So, the need for developing novel NNRT inhibitors still exists and research in this hot topic continues.

The discovery of a series of novel oxindoles as HIV-1 non-nucleoside reverse transcriptase inhibitors has been reported^{30,31,33} as well as their preliminary SAR. Compound **15a** (see Scheme 1) was identified with ~75nM EC₅₀ using a cell-based HIV reporter infection assay, screening hit. After establishing the stereochemistry and confirmation of activity of **15a**, analogs with different substituents on the aromatic ring were synthesized and evaluated for anti-HIV activity (see Schemes 2 and 3). Among them, the best anti-HIV activity was observed for *cis*-isomer of compound **24a** (EC₅₀ 0.040 μM) and *cis*-isomer of **24b** with EC₅₀ 0.059 μM and **13b** (EC₅₀ 0.066μM). Taking into account that ester moieties are metabolically unstable, the authors reported results of their efforts to replace the ester moiety with its tetrazoles. From two synthesized compounds one **21b** (EC₅₀ 0.005 μM) was active while another one **21c** inactive (EC₅₀ >10 μM). The replacement of ester/tetrazole moiety with aryl or hetero/heteroaryl moieties led to new series of compounds. Among furan derivatives, the most potent were **21d** and **21e** (Scheme 2) with an EC₅₀ of 73 and 27 nM, respectively, while among 2-thiophene analogs, only **21f** exhibit strong activity. The highest activity was observed for 3-thiophen analog **21g** with EC₅₀ of 6nM. Much better activity was observed for the 2-pyridinyl analog **19c** with EC₅₀ 8 nM, comparable to Efavirenz (EC₅₀ 5 nM).

It is worth noting that oxindol derivatives featuring spiro-cyclopropane units **25k–o** and **26k–o**, (Scheme 3) became a focus of our attention due to their promising activity as HIV-1 integrase inhibitors.³⁵ Biological evaluation of these compounds revealed that half of the tested compounds exhibited inhibitory action. Inhibition varied, depending on the type and position (*cis* or *trans*) of the substituents. Addition of two halogen substituents at the phenyl ring resulted in the most active compound **25k** (27.3%).

Spiro compounds are also known for their antimycobacterial properties.¹³⁹ Spiro compounds⁵¹ (see Scheme 13) were screened for their *in vitro* activity against Mycobacterium tuberculosis H37Rv (MTB), multi-drug resistant M. tuberculosis (MDR-TB) and Mycobacterium smegmatis (MC2) using agar dilution method. Among the synthesized compounds, spirooxindole-piperidin-4-one **57e** was found to be the most active with a minimum inhibitory concentration (MIC) of 1.76 and 0.88 μM against MTB and MDR-TB, respectively.

Anti-inflammatory properties of the prepared compounds **57b–d**⁵⁵ (at a dose of 50 mg/kg body weight) using *in vivo* acute carrageenan-induced paw oedema in rats showed that all the tested compounds possess considerable anti-inflammatory activity which reveal remarkable activities with potency 125.5%, 139.3% and 126.4%, respectively, relative to indomethacin which was used as a reference standard (at a dose of 10 mg/kg body weight).

In vitro antitubercular screening of synthesized compounds⁶³ (see Scheme 14) against Mycobacterium tuberculosis H37Rv (MTB) disclosed that spirooxindolethiazole **59a** has the maximum potency with a minimum inhibitory concentration (MIC) of 1.4 IM against MTB, being 3.4 and 5.4 times more potent than ciprofloxacin and ethambutol, respectively.

Wang *et al.*⁷⁷ reported that the most potent inhibitor (Scheme 17) of the MDM2-p53 interaction **69i** has a K_i value of 86 nM. After structural modifications of **69i**, it was found that the synthesized compound **69j**⁷⁸ binding to MDM2 with a K_i of 13 nM in FP-based binding assay.⁷⁸ Some further modifications on compound **69j** led to compound **69k** with a K_i value of 3 nM, concerning its binding to MDM2. This

compound **69k** is 12 times more potent than Nutlin-(K_i value of 36 nM) probably the most potent cell-permeable nonpeptide inhibitor of the MDM2-p53 interaction reported¹⁴⁰ and much more potent than the natural p53 peptide.⁷⁷

Xenon Pharmaceuticals Inc reported¹⁰⁴ a development of a series of NaV1.7 blockers, starting from the 3-hydroxy-2-oxindole **110** (IC_{50} 0.03 μ M, ClogP 3.56 and solubility 37 μ g/mL) (see Scheme 28). Further optimization and modifications of compound **110** led to compound **111** (XEN907) (hNaV1.7 IC_{50} 0.003 μ M, ClogP 3.97 and solubility 7.3 μ g/mL) which was 10-fold more potent than compound **110** and without significant activity at 10 μ M against a broad panel of 63 receptors and transporters.

The biological evaluation of the series of spirooxindoles **99**⁸⁸ (see Scheme 24) on fever by intracerebroventricular (icv) injection of lipopolysaccharide (LPS, a component of the outer membrane of Gram-negative bacteria) using a model of acute neuroinflammation in mice revealed promising antipyretic activity and provided an opportunity to discover new antipyretic agents. LPS-induced fever was significantly reduced by coinjection of several analogues, including **99b** (20 nmol, $p < 0.05$) and **99a** (20 nmol, $p < 0.05$); **99b** (20 nmol) or **99a** (20 nmol) given alone into the third ventricle did not significantly alter the body temperature.

Mycobacterium tuberculosis protein tyrosine phosphatases A (MtpA) and B (MtpB) mediate pathogen survival in macrophages by the dephosphorylation of host proteins that are involved in key pathways of the immune system.⁹⁹ It was discovered that spirooxindoles **100** (see Scheme 24) showed excellent selectivity in favour of MtpB; the other phosphatases were not inhibited significantly by the compounds at a concentration of 50 μ M.

The synthesized spirooxindoles¹⁰⁵ **114** (see Scheme 29) exhibited different cytotoxicity. In particular, spirooxindol **114a** turned out to be the most cytotoxic for MT-4 cell lines. As far as antiviral activity is concerned, synthesized spirooxindoles turned out to be active against Reo-1, Sb-1, VSV, RSV, YFV and VV viruses. The results obtained against Bovine Viral Diarrhoea Virus (BVDV) showed that compounds **114b** and **108a** exhibited moderate active. It should be noticed that compound **114a** showed moderate activity against HIV-1 ($EC_{50} > 16\text{--}m > 59\mu$ M).

9. Conclusions

Isatins are probably some of the most investigated products nowadays. The abundance of benzopyrrole ring with keto group and the availability of either the lactime or lactame group (depending on nature and amount of reagent, nature of used solvent and temperature) make them the most common candidates for an entry to diversely functionalized spirocyclic oxindoles.

The main topic of this review is the discussion on the different strategies for the synthesis of three-, four-, five-, six- and seven-membered heterocycles spiro fusion to a pyrrolidine ring at the 3-position of the oxindole core. Based on the biological importance of chirality, pharmaceutical, agrochemical, flavour and fragrance industries invest heavily into development of asymmetric technologies where chiral pool reagents play a significant role. In sections 3.5 and 6 the potential of isatins in the synthesis of enantiopure products is given. The main topic of section 7 is the correlation of structure and bioactivity. There is a most straightforward correlation between heterocycles spiro fusion and side chain modification of isatins. The authors have attempted this difficult task in order to provide some practical guidelines for all those who wish to familiarize themselves with this domain and to provide useful information to those who are contributing actively to the extraordinary evolution of this field.

Acknowledgments

The authors (F.M. and N.S.) gratefully acknowledge generous financial support from the Royal Society International Joint Project 2009-2011(Ref. № JP090309).

References

1. Macaev, F. *Synthesis of Spiroindolin-2-ones from 1H-Indole-2,3-dione* In *Selected Methods for Synthesis and Modification of Heterocycles. The Chemistry of Synthetic Indole Systems*; Kartsev, V. G. Ed.; IBS press: Moscow, 2004; Vol. 3, p. 75.
2. Taylor, J. G.; Moro, A. V.; Correia, C. R. D. *Eur. J. Org. Chem.* **2011**, 8, 1403.
3. Jiang, L.; Chen, Y. C. *Catal. Sci. Technol.* **2011**, 1, 354.
4. Moyano, A.; El-Hamdouni, N.; Atlamsani, A. *Chem. Eur. J.* **2010**, 16, 5260.
5. Westermann, B.; Ayaz, M.; van Berkel, S. S. *Angew. Chem. Int. Ed.* **2010**, 49, 846.
6. Marques-Lopez, E.; Herrera, R. P.; Christmann, M. *Nat. Prod. Rep.* **2010**, 27, 1138.
7. Zhou, F.; Liu, Y.-L.; Zhou, J. *Adv. Synth. Catal.* **2010**, 352, 1381.
8. Trost, B. M.; Brennan, M. K. *Synthesis* **2009**, 18, 3003.
9. Carson, C. A.; Kerr, M. A. *Chem. Soc. Rev.* **2009**, 38, 3051.
10. Ishikura, M.; Yamada, K. *Nat. Prod. Rep.* **2009**, 26, 803.
11. Lu, Z.; Ma, S. *Angew. Chem. Int. Ed.* **2008**, 47, 258.
12. Scott, P. J. H.; Steel, P. G. *Eur. J. Org. Chem.* **2006**, 10, 2251.
13. Arrayas, R. G.; Adrio, J.; Carretero, J. C. *Angew. Chem. Int. Ed.* **2006**, 45, 7674.
14. Arndt, H. D. *Angew. Chem. Int. Ed.* **2006**, 45, 4552.
15. Nicolaou, K. C.; Snyder, S. A. *Angew. Chem. Int. Ed.* **2005**, 44, 1012.
16. Nicolaou, K. C.; Bulger, P. G.; Sarlah, D. *Angew. Chem. Int. Ed.* **2005**, 44, 4442.
17. Cesar, V.; Bellemin-Laponnaz, S.; Gade, L. H. *Chem. Soc. Rev.* **2004**, 33, 619.
18. Marti, C.; Carreira, E. M. *Eur. J. Org. Chem.* **2003**, 2209.
19. Baeyer, K. *Ann.* **1866**, 140, 1.
20. Millemaggi, A.; Taylor, R. J. K. *Eur. J. Org. Chem.* **2010**, 4527.
21. Lim, K. H.; Sim, K. M.; Tan, G. H.; Kam, T. S. *Phytochemistry* **2009**, 70, 1182.
22. Kam, T. S.; Choo, Y. M. *Phytochemistry* **2004**, 65, 603.
23. Willing, R. I.; Vit, I.; Flower, K.; Edgar, J.; Colegate, S. M.; Cocrum, P. A.; Anderton, N. *Phytochemistry* **1998**, 48, 437.
24. Stratmann, K.; Moore, R. E.; Bonjouklian, R.; Deeter, J. B.; Patterson, G.; Shaffer, S.; Smith, C. D.; Smitka, T. A. *J. Am. Chem. Soc.* **1994**, 116, 9935.
25. Jimenez, J. I.; Huber, U.; Moore, R. E.; Patterson, G. M. J. *J. Nat. Prod.* **1999**, 62, 569.
26. Faust, R. *Angew. Chem. Int. Ed.* **2001**, 40, 2251.
27. *Comprehensive Medicinal Chemistry*; Hansch, C.; Sammes, P. G.; Taylor, J. B.; Drayton, C. J., Eds.; Pergamon: Oxford, UK, 1990; Vol. 6.
28. Yoshimatsu, M.; Ohara, M. *Tetrahedron Lett.* **1997**, 38, 5651.
29. Agami, C.; Dechoux, L.; Doris, E.; Mioskowski, C. *Tetrahedron Lett.* **1997**, 38, 4071.
30. Jiang, T.; Kuhen, K. L.; Wolff, K.; Yin, H.; Bieza, K.; Caldwell, J.; Bursulaya, B.; Tuntland, T.; Zhang, K.; Karanewsky, D.; He, Y. *Bioorg. Med. Chem. Lett.* **2006**, 16, 2109.
31. Jiang, T.; Kuhen, K. L.; Wolff, K.; Yin, H.; Bieza, K.; Caldwell, J.; Bursulaya, B.; Wu, T. Y. H.; He, Y. *Bioorg. Med. Chem. Lett.* **2006**, 16, 2105.
32. Kumari, G.; Nutan, I.; Modi, M.; Gupta, S. K.; Singh, R. K. *Eur. J. Med. Chem.* **2011**, 46, 1181–1188.
33. Marti, C.; Carreira, E. M. *J. Am. Chem. Soc.* **2005**, 127, 11505.
34. Chen, S.; Ma, J.; Wang, J. *Tetrahedron Lett.* **2008**, 49, 6781.
35. Surmava, S.; Elefthetiou, P.; Geronikaki, A.; Petrou, C.; Macaev, F.; Sucman, N. *XVIII International AIDS Conference*, Viena, Austria, **2010**, p. 56.
36. Muthusamy, S.; Azhagan, D.; Gnanaprakasam, B.; Suresh, E. *Tetrahedron Lett.* **2010**, 51, 5662.
37. Ammetto, I.; Gasperi, T.; Loreto, M. A.; Migliorini, A.; Palmarelli, F.; Tardella, P. A. *Eur. J. Org. Chem.* **2009**, 35, 6189.
38. Gasperi, T.; Loreto, M. A.; Migliorini, A.; Ventura, C. *Eur. J. Org. Chem.* **2011**, 42, 385.

39. Pesciaioli, F.; Righi, P.; Mazzanti, A.; Bartoli, G.; Bencivenni, G. *Chem. Eur. J.* **2011**, *17*, 2842.
40. Yu, H.; Liu, Y.; Shang, H.; Chen, J.; Deng, H.; Shao, M.; Ren, Z.; Cao, W. *Tetrahedron* **2010**, *66*, 2598.
41. Schulz, V.; Davoust, M.; Lemarie, M.; Lohier, J. F.; Santos, J. S. O.; Metzner, P.; Briere, J. F. *Org. Lett.* **2007**, *9*, 1745.
42. Yong, S. R.; Ung, A. T.; Pyne, S. G.; Skelton, B. W.; White, A. H. *Tetrahedron* **2007**, *63*, 1191.
43. Lingam, K. A. P.; Mandal, A. B.; Shanmugam, P. *Tetrahedron Lett.* **2011**, *52*, 3610.
44. Basavaiah, D.; Rao, A. J.; Satyanarayana, T. *Chem. Rev.* **2003**, *103*, 811.
45. Derewes, S. E.; Roos, G. H. P. *Tetrahedron* **1988**, *44*, 4653.
46. Shanmugam, P.; Vaithianathan, V.; Viswambharan, B. *Tetrahedron* **2006**, *62*, 4342.
47. Sargorovschi, V.; Sucman, N.; Iudin, T.; Stingaci, E.; Macaev, F. *Chem. J. Moldova* **2010**, *5*, 109.
48. Sargorovschi, V.; Sucman, N.; Iudin, T.; Duca, D.; Stingaci, E.; Macaev, F. MD patent 4062, from 01.16. **2010**.
49. Morales-Rios, M. S.; Gonzalez-Juarez, D. E.; Rivera-Becerril, E.; Suarez-Castillo, O. R.; Joseph-Nathan, P. *Tetrahedron* **2007**, *63*, 7702.
50. Milanese, M.; Viterbo, D. *J. Org. Chem.* **2000**, *65*, 3416.
51. Kumar, R. R.; Perumal, S.; Senthilkumar, P.; Yogeewari, P.; Sriram, D. *Eur. J. Med. Chem.* **2009**, *44*, 3821.
52. Ghandi, M.; Taheri, A.; Abbasi, A. *Tetrahedron* **2010**, *66*, 6744.
53. Jayashankaran, J.; Manian, R. D. R. S.; Raghunathan, R. *Tetrahedron Lett.* **2004**, *45*, 7303.
54. Lakshmi, N. V.; Thirumurugan, P.; Perumal, P. T. *Tetrahedron Lett.* **2010**, *51*, 1064.
55. Girgis, A. S. *Eur. J. Med. Chem.* **2009**, *44*, 1257.
56. Hazra, A.; Paira, P.; Sahu, K. B.; Naskar, S.; Saha, P.; Paira, R.; Mondal, S.; Maity, A.; Luger, P.; Weber, M.; Mondal, N. B.; Banerjee, S. *Tetrahedron Lett.* **2010**, *51*, 1585.
57. Babu, A. R. S.; Raghunathan, R. *Tetrahedron Lett.* **2008**, *49*, 4487.
58. Shvets, A. A.; Kurbatov, S. V. *Chem. Heterocycl. Compd.* **2009**, *45*, 866.
59. Ghandi, M.; Yari, A.; Rezaei, S. J. T.; Taheri, A. *Tetrahedron Lett.* **2009**, *50*, 4724.
60. Rehn, S.; Bergman, J.; Stensland, B. *Eur. J. Org. Chem.* **2004**, 413.
61. Lakshmi, N. V.; Arun, Y.; Perumal, P. T. *Tetrahedron Lett.* **2011**, *52*, 3437.
62. Shanmugam, P.; Viswambharan, B.; Madhavan, S. *Org. Lett.* **2007**, *9*, 4095.
63. Maheswari, S. U.; Balamurugan, K.; Perumal, S.; Yogeewari, P.; Sriram, D. *Bioorg. Med. Chem. Lett.* **2010**, *20*, 7278.
64. Babu, A. R. S.; Raghunathan, R.; Baskaran, S. *Tetrahedron* **2009**, *65*, 2239.
65. Alimohammadi, K.; Sarrafi, Y.; Tajbakhsh, M.; Yeganegi, S.; Hamzehloueian, M. *Tetrahedron* **2011**, *67*, 1589.
66. Babu, A. R. S.; Raghunathan, R. *Tetrahedron Lett.* **2007**, *48*, 6809.
67. Ganguly, A. K.; Seah, N.; Popov, V.; Wang, C. H.; Kuang, R.; Saksena, A. K.; Pramanik, B. N.; Chan, T. M.; McPhail, A. T. *Tetrahedron Lett.* **2002**, *43*, 8981.
68. Shanmugam, P.; Viswambharan, B.; Selvakumar, K.; Madhavan, S. *Tetrahedron Lett.* **2008**, *49*, 2611.
69. Selvakumar, K.; Vaithianathan, V.; Shanmugam, P. *Chem. Commun.* **2010**, *46*, 2826.
70. Shanmugam, P.; Vaithianathan, V. *Tetrahedron* **2008**, *64*, 3322.
71. Yavari, I.; Hossaini, Z.; Sabbaghan, M.; Ghazanfarpour-Darjani, M. *Tetrahedron* **2007**, *63*, 9423.
72. Esmaili, A. A.; Bodaghi, A. *Tetrahedron* **2003**, *59*, 1169.
73. Galliford, C. V.; Martenson, J. S.; Stern, C.; Scheidt, K. A. *Chem. Commun.* **2007**, 631.
74. Liu, T.-L.; Xue, Z.-Y.; Tao, H.-Y.; Wang, C.-J. *Org. Biomolec. Chem.* **2011**, *9*, 1980.
75. Ding, K.; Wang, G.; Deschamps, J. R.; Parrishb, D. A.; Wang, S. *Tetrahedron Lett.* **2005**, *46*, 5949.
76. Chen, C.; Li, X.; Neumann, C. S.; Lo, M. M. C.; Schreiber, S. L. *Angew. Chem. Int. Ed.* **2005**, *44*, 2249.
77. Ding, K.; Lu, Y.; Nikolovska-Coleska, Z.; Qiu, S.; Ding, Y.; Gao, W.; Stuckey, J.; Krajewski, K.; Roller, P. P.; Tomita, Y.; Parrish, D. A.; Deschamps, J. R.; Wang, S. *J. Am. Chem. Soc.* **2005**, *127*, 10130.
78. Ding, K.; Lu, Y.; Nikolovska-Coleska, Z.; Wang, G.; Qiu, S.; Shangary, S.; Gao, W.; Qin, D.; Stuckey, J.; Krajewski, K.; Roller, P. P.; Wang, S. *J. Med. Chem.* **2006**, *49*, 3432.
79. Yu, S.; Qin, D.; Shangary, S.; Chen, J.; Wang, G.; Ding, K.; McEachern, D.; Qiu, S.; Nikolovska-Coleska, Z.; Miller, R.; Kang, S.; Yang, D.; Wang, S. *J. Med. Chem.* **2009**, *52*, 7970.
80. Onishi, T.; Sebahar, P. R.; Williams, R. M. *Tetrahedron* **2004**, *60*, 9503.
81. Sebahar, P. R.; Williams, R. M. *J. Am. Chem. Soc.* **2000**, *122*, 5666.
82. Onishi, T.; Sebahar, P. R.; Williams, R. M. *Org. Lett.* **2003**, *5*, 3135.
83. Basavaiah, D.; Rao, J. S.; Reddy, R. J.; Rao, A. J. *Chem. Commun.* **2005**, 2621.

84. Badillo, J. J.; Arevalo, G. E.; Fettinger, J. C.; Franz, A. K. *Org. Lett.* **2011**, *13*, 418.
85. Basavaiah, D.; Reddy, K. R. *Org. Lett.* **2007**, *9*, 57.
86. Muthusamy, S.; Ramkumar, R.; Mishra, A. K. *Tetrahedron Lett.* **2011**, *52*, 148.
87. Franz, A. K.; Dreyfuss, P. D.; Schreiber, S. L. *J. Am. Chem. Soc.* **2007**, *129*, 1020.
88. Savitha, G.; Niveditha, S. K.; Muralidharan, D.; Perumal, P. T. *Tetrahedron Lett.* **2007**, *48*, 2943.
89. Alcaide, B.; Almendros, P.; Rodriguez-Acebes, R. *J. Org. Chem.* **2006**, *71*, 2346.
90. Alcaide, B.; Almendros, P.; Rodriguez-Acebes, R. *Chem. Eur. J.* **2005**, *11*, 5708.
91. Chen, X.-H.; Wei, Q.; Luo, S.-W.; Xiao, H.; Gong, L.-Z. *J. Am. Chem. Soc.* **2009**, *131*, 13819.
92. Voituriez, A.; Pinto, N.; Neel, M.; Retailleau, P.; Marinetti, A. *Chem. Eur. J.* **2010**, *16*, 12541.
93. Tan, B.; Candeias, N. R.; Barbas, C. F. *J. Am. Chem. Soc.* **2011**, *133*, 4672.
94. Nair, V.; Vellalath, S.; Poonoth, M.; Mohan, R.; Suresh, E. *Org. Lett.* **2006**, *8*, 507.
95. Singh, A.; Roth, G. P. *Org. Lett.* **2011**, *13*, 2118.
96. Jiang, X.; Cao, Y.; Wang, Y.; Liu, L.; Shen, F.; Wang, R. *J. Am. Chem. Soc.* **2010**, *132*, 15328.
97. Chen, W.-B.; Wu, Z.-J.; Hu, J.; Cun, L.-F.; Zhang, X.-M.; Yuan, W.-C. *Org. Lett.* **2011**, *13*, 2472.
98. Khanna, P.; Saxena, A.; Khanna, L.; Bhagat, S.; Jain, S. C. *Arkivoc* **2009**, *vii*, 119.
99. Vintonyak, V. V.; Warburg, K.; Kruse, H.; Grimme, S.; Hubel, K.; Rauh, D.; Waldmann, H. *Angew. Chem. Int. Ed.* **2010**, *49*, 5902.
100. Tan, B.; Candeias, N. R.; Barbas III, C. F. *Nature Chem.* **2011**, *6*, 473.
101. Wang, L.; Zhang, Y.; Hu, H.-Y.; Fun, H. K.; Xu, J.-H. *J. Org. Chem.* **2005**, *70*, 3850.
102. Viswambharan, B.; Selvakumar, K.; Madhavan, S.; Shanmugam, P. *Org. Lett.* **2010**, *12*, 2108.
103. Makaev, F. Z.; Radul, O. M.; Shterbet, N.; Pogrebnoi, S. I.; Sucman, N. S.; Malinovskii, S. T.; Barba, A. N.; Gdaniec, M. *Chem. Heterocycl. Compd.* **2007**, *43*, 289.
104. Chowdhury, S.; Chafeev, M.; Liu, S.; Sun, J.; Raina, V.; Chui, R.; Young, W.; Kwan, R.; Fu, J.; Cadieux, J. A. *Bioorg. Med. Chem. Lett.* **2011**, *21*, 3676.
105. Radul, O. M.; Sucman, N. S.; Pogrebnoi, S.; Barba, A.; Geronikaki, A.; Macaev, F. *Chem. J. Mold.* **2011**, *6*, 101.
106. Ma, S.; Han, X.; Krishnan, S.; Virgil, S. C.; Stoltz, B. M. *Angew. Chem. Int. Ed.* **2009**, *48*, 8037.
107. Shanmugam, P.; Viswambharan, B. *Synlett* **2008**, *18*, 2763.
108. U. K. Syam, K.; Hiriyakkanavar, I.; Hiriyakkanavar, J. *Org. Lett.* **2001**, *3*, 4193.
109. Kulkarni, M. G.; Dhondge, A. P.; Chavhan, S. W.; Borhade, A. S.; Shaikh, Y. B.; Birhade, D. R.; Desai, M. P.; Dhatr, N. R. *Beilstein J. Org. Chem.* **2010**, *6*, 876.
110. Allous, I.; Comesse, S.; Berkeš, D.; Alkyat, A.; Daich, A. *Tetrahedron Lett.* **2009**, *50*, 4411.
111. Coote, S. C.; Quenum, S.; Procter, D. *J. Org. Biomol. Chem.* **2011**, *9*, 5104.
112. Siegel, D. R.; Carreira, E. M. *Angew. Chem. Int. Ed.* **1999**, *38*, 3186.
113. Lerchner, A.; Carreira, E. M. *J. Am. Chem. Soc.* **2002**, *124*, 14826.
114. Lerchner, A.; Carreira, E. M. *Chem. Eur. J.* **2006**, *12*, 8208.
115. Pellegrino, S.; Clerici, F.; Contini, A.; Leone, S.; Pilati, T.; Gelmi, M. L. *Tetrahedron* **2009**, *65*, 1995.
116. Kouznetsov, V. V.; Bello Forero, J. S.; Amado Torres, D. F. *Tetrahedron Lett.* **2008**, *49*, 5855.
117. Alizadeh, A.; Mokhtari, J. *Tetrahedron* **2011**, *67*, 3519.
118. Jiang, K.; Jia, Z.-J.; Chen, S.; Wu, L.; Chen, Y.-C. *Chem. Eur. J.* **2010**, *16*, 2852.
119. Bencivenni, G.; Wu, L. Y.; Mazzanti, A.; Giannichi, B.; Pesciaioli, F.; Song, M. P.; Bartoli, G.; Melchiorre, P. *Angew. Chem.* **2009**, *121*, 7336.
120. Wie, Q.; Gong, L.-Z. *Org. Lett.* **2010**, *12*, 1008.
121. Chen, W. B.; Wu, Z.-J.; Pei, Q. L.; Cun, L. F.; Zhang, X. M.; Yuan, W.-C. *Org. Lett.* **2010**, *12*, 3132.
122. Macaev, F.; Sucman, N.; Shepeli, F.; Zveaghintseva, M.; Pogrebnoi, V. *Symmetry* **2011**, *3*, 165.
123. Jiang, K.; Jia, Z.-J.; Yin, X.; Wu, L.; Chen, Y.-C. *Org. Lett.* **2010**, *12*, 2766.
124. Wang, J.; Crane, E. A.; Scheidt, K. A. *Org. Lett.* **2011**, *13*, 3086.
125. Castaldi, M. P.; Troast, D. M.; Porco, J. A., Jr. *Org. Lett.* **2009**, *11*, 3362.
126. Balamurugan, K.; Perumal, S.; Menendez, J. C. *Tetrahedron* **2011**, *67*, 3201.
127. Quiroga, J.; Portillo, S.; Perez, A.; Galvez, J.; Abonia, R.; Insuasty, B. *Tetrahedron Lett.* **2011**, *52*, 2664.
128. Ghahremanzadeh, R.; Ahadi, S.; Shakibaei, G. I.; Bazgir, A. *Tetrahedron Lett.* **2010**, *51*, 499.
129. Dabiri, M.; Tisseh, N. Z.; Bahramnejad, M.; Bazgir, A. *Ultrasonics Sonochemistry* **2011**, *18*, 1153.
130. England, D. B.; Merey, G.; Padwa, A. *Org. Lett.* **2007**, *9*, 3805.

131. James, K. M.; Willetts, N.; Procter, D. *J. Org. Lett.* **2008**, *10*, 1203.
132. Zhang, Y.; Panek, J. S. *Org. Lett.* **2009**, *11*, 3366.
133. Sebastian, J.; Faruki, H. *Med. Res. Rev.* **2004**, *24*, 115.
134. Gotte, M. *Expert Rev. Anti-Infect. Ther.* **2004**, *2*, 707.
135. Mugavero, M. J.; Hicks, C. B. *Drug Discovery Today: Ther. Strategies* **2004**, *1*, 529.
136. Rusconi, S.; La Seta Catamancio, S.; Citterio, P.; Bulgheroni, E.; Kurtagic, S.; Galazzi, M.; Croce, F.; Moroni, M.; Galli, M. *Antiviral Ther.* **2001**, *6*, 41.
137. Miller, V.; Ait-Khaled, M.; Stone, C.; Griffin, P.; Mesogiti, D.; Cutrell, A.; Harrigan, R.; Staszewski, S.; Katlama, C.; Pearce, G.; Tisdale, M. *AIDS* **2000**, *14*, 163.
138. Pauwels, R. *Curr. Opin. Pharmacol.* **2004**, *4*, 437.
139. Chande, M. S.; Verma, R. S.; Barve, P. A.; Khanwelkar, R. R. *Eur. J. Med. Chem.* **2005**, *40*, 1143.
140. Vassilev, L. T.; Vu, B. T.; Graves, B.; Carvajal, D.; Podlaski, F.; Filipovic, Z.; Kong, N.; Kammlott, U.; Lukacs, C.; Klein, C.; Fotouhi, N.; Liu, E. A. *Science* **2004**, *303*, 844.

RECENT ADVANCES IN MICROWAVE-ASSISTED HETEROCYCLIC CHEMISTRY. SYNTHESIS OF THREE, FOUR AND FIVE-MEMBERED HETEROCYCLES

Mohsine Driowya,^{a,b} Khalid Bougrin^{*b} and Rachid Benhida^{*a}

^aLaboratoire de Chimie des Molécules Bioactives et des Arômes, UMR 6001 UNS-CNRS, Institut de Chimie de Nice, Université de Nice-Sophia Antipolis, Parc Valrose, F-06108 Nice Cedex 2, France
(e-mail: benhida@unice.fr).

^bLaboratoire de Chimie des Plantes et de Synthèse Organique et Bioorganique, URAC23, Université Mohammed V-Agdal, Faculté des Sciences B.P. 1014 Rabat, Maroc (e-mail: kbougrin@yahoo.fr)

Abstract. This chapter aims to review recent developments in the synthesis of three, four and five membered rings heterocyclic compounds under conditions that include the application of microwave irradiation in the ring-forming step. It is assembled according to the main heterocycle types in order of increasing complexity starting with heterocyclic systems containing one, two, three and four heteroatoms and their fused analogues. Selected examples of microwave-assisted heterocyclic reactions from the 2006 to 2011 literature are discussed.

Contents

1. Introduction
2. Heterocycles synthesis
 - 2.1. Three-membered heterocycles with one heteroatom
 - 2.1.1. Aziridines
 - 2.1.2. Oxiranes
 - 2.1.3. Thiiranes
 - 2.2. Four-membered heterocycles with one heteroatom
 - 2.2.1. β -Lactams
 - 2.3. Five-membered heterocycles with one heteroatom
 - 2.3.1. Pyrroles, thiophenes and furanes
 - 2.3.2. Indoles, benzofurans and benzothiophenes
 - 2.4. Five-membered heterocycles with two heteroatoms
 - 2.4.1. Imidazoles
 - 2.4.2. Pyrazoles
 - 2.4.3. Oxazoles and isoxazoles
 - 2.4.4. Thiazoles
 - 2.4.5. Benzimidazoles, benzoxazoles and benzothiazoles
 - 2.5. Five-membered heterocycles with three heteroatoms
 - 2.5.1. Triazoles
 - 2.5.1.1. Synthesis of 1,2,3-triazoles
 - 2.5.1.1.1. Synthesis using Cu^{II} salts
 - 2.5.1.1.2. Synthesis using Cu^I salts

2.5.1.1.3. Synthesis using Cu⁰ and Cu^{II}

2.5.1.1.4. Other methods for the synthesis of 1,2,3-triazoles

2.5.1.2. Synthesis of 1,2,4-triazoles

2.5.2. Oxadiazoles and thiadiazoles

2.6. Five-membered heterocycles with four heteroatoms

2.6.1. Tetrazoles

3. Conclusion

Acknowledgments

References

1. Introduction

The use of microwaves to heat organic reactions has become very important in organic synthesis and it is logical to affirm that there are now very few areas of synthetic organic chemistry that have not been shown to be enhanced using microwave activation. Despite the area of microwave-assisted chemistry being twenty years old, the technique has only recently received widespread global acceptance in academia and industry. This technique allows a number of advantages over conventional heating such as no contact heating, energy transfer instead of heat transfer bound to penetrative aspect of microwaves irradiation, material-selective and volumetric heating, fast start-up and stopping. Heating in microwave cavities is based upon the ability of some polar liquids and solids to absorb and transform electromagnetic energy into heat.

Thus, if one or more species in the reaction mixture has a permanent dipole, then dielectric heating by irradiation with microwave energy, at 2.45 GHz, will be possible. Hence, solvents such as methanol, DMF, acetonitrile, ethyl acetate and water are commonly employed in microwave-enhanced reactions. Hexane, and similar solvents, containing no dipole do not couple with microwave energy. Therefore, in this case one of the reaction components must contain a dipole.¹ Furthermore, in-core volumetric heating can remove the formation of by-products and unwanted side-reactions on the hot surface of a reaction vessel, resulting in cleaner reactions.²

The use of microwave technology in organic synthesis has gained considerable interest with more than 5000 publications by the middle of 2010 since the pioneering works of Gedye and Giguere in 1986.³

The significant advantages of this alternative technology are exploited not only in organic and medicinal chemistry but also in other fields such as natural products synthesis, polymers synthesis, material sciences, nanotechnology, essential oil extraction and biochemical processes.⁴ In this context, the interest in the applications of microwave-assisted organic synthesis is related to the possibility of having more rapid access to large libraries of diverse small molecules and heterocyclic compounds with biological properties.⁵

Heterocycles are extremely important molecules in largest areas of research in organic chemistry. The presence of heterocycles in all kinds of organic compounds of interest in biology, pharmacology, optics, electronics, material sciences, and so on is well known. Not surprisingly, microwave-assisted synthesis of heterocycles has been a topic of numerous reviews, books and chapter books during the last five years.⁶ For all these reasons, the aim of the present review is to provide substantive applications of microwave dielectric heating to facilitate rapid synthesis of different heterocycles formed through cyclocondensation, cycloaddition reactions or other modular reactions. In this chapter, recent examples of microwave-assisted organic transformations are surveyed in non-exhaustive way.

The survey of heterocycles synthesis is arranged according to ring-size number of heteroatoms in the ring, beginning with three, four and five-membered ring systems containing one, two, three and four heteroatoms and their fused-ring analogues. The six- and seven-membered rings and macrocyclic systems are not addressed in this issue and will be given in the next chapter.

2. Heterocycles synthesis

2.1. Three-membered heterocycles with one heteroatom

2.1.1. Aziridines

Aziridines, the smallest heterocycles, are an important class of compounds in organic chemistry. Generally, these systems have been obtained by 1,3-dipolar cycloaddition of azides with alkenes as *N*-substituted 2-azabicyclo[2.2.1]hept-5-en-3-ones,⁷ fullerene C₆₀⁸ and single-walled carbon nanotubes (SWCNT),⁹ in polar solvent (*o*-dichlorobenzene, chlorobenzene or DMF) under higher temperature and nitrogen gas pressure. Interesting access to aziridines by using [Fe^{III}(F₂₀-tpp)Cl] (F₂₀-tpp=meso-tetrakis (pentafluorophenyl)porphyrinato dianion as an effective catalyst for imido/nitrene insertion reactions of sulfonyl and aryl azides as nitrogen source in anhydrous 1,2-dichloroethane was recently reported (Scheme1).¹⁰ Under thermal conditions, aziridination of aryl and alkyl alkenes (16 examples, 75–95% yields) can be accomplished by using 2 mol% [Fe^{III}(F₂₀-tpp)Cl] as catalyst. Under microwave irradiation conditions in CEM Discover Synthesis Unit at 100 °C, the reaction time of aziridination can be reduced by up to 16-fold (24–48 hours vs 1–2.5 hours) without significantly affecting the product yield and conversion rate.

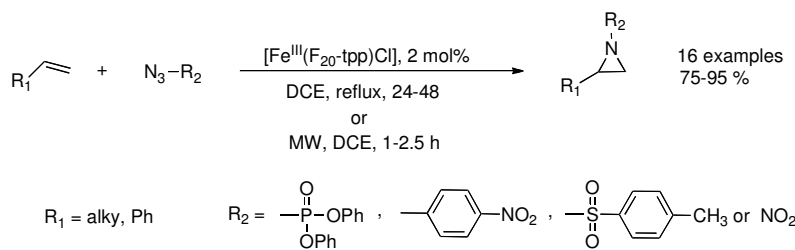

Scheme 1

Recently, Gayon *et al.* reported an atom-economical synthesis of *cis-N*-benzenesulfonamide acylaziridines through the Baldwin rearrangement of *N*-benzenesulfonamide isoxazolines under thermal and microwave activation (Scheme 2).¹¹ Different solvents were examined under microwave irradiation including DMSO, H₂O, CH₃CN, toluene, EtOH and *i*-PrOH. Among them, DMSO and H₂O allowed good conversion level but also induced extensive degradation of products, whereas CH₃CN at 110 °C gave better yields and increased diastereoselectivity in favour of the *cis*-isomer. Under microwave irradiation, the reaction time was significantly reduced compared to thermal conditions.

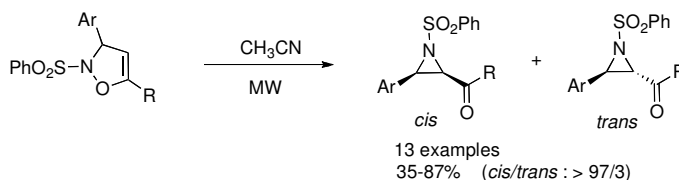

Scheme 2

2.1.2. Oxiranes

Oxiranes also known as epoxides are useful intermediates in multistep organic syntheses and asymmetric catalysis. Therefore, a large number of methods are available for their preparation and utilization.¹² In the case of microwave activation, the catalytic epoxidation of alkenes with hydrogen peroxide (H_2O_2) retains a major interest. Berardi *et al.* reported an efficient microwave-assisted epoxidation of olefins using $[\gamma\text{-SiW}_{10}\text{O}_{36}(\text{PhPO})_2]^{4-}$ and H_2O_2 (Scheme 3).¹³ This process was highly efficient since the reaction occurred, in hydrophobic ionic liquids (ILs) in presence of recyclable catalyst, with yields and selectivity up to 99%. Under microwave irradiation, the reaction occurred with up to 200 turnovers per minute. Simultaneous cooling was needed for quantitative H_2O_2 conversion. Microwave experiments were performed with continuous irradiation power (10 W) and simultaneous cooling ($T_{\text{bulk}} < 80^\circ\text{C}$). This approach significantly minimizes the longer reaction times required under conventional heating.

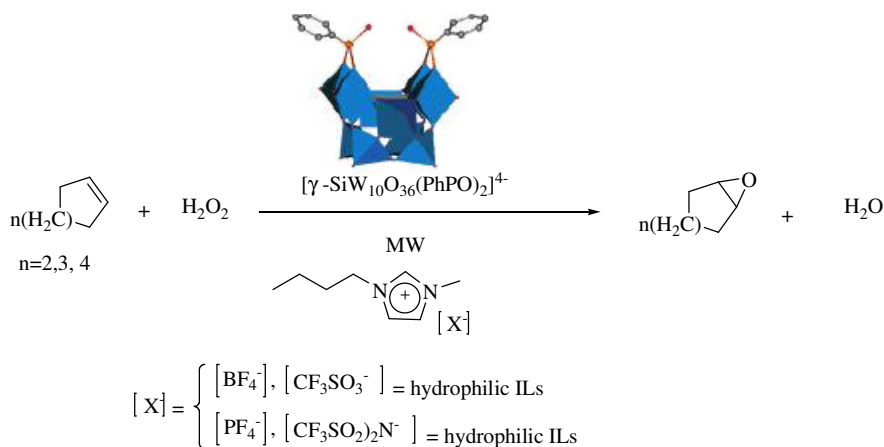

Scheme 3

2.1.3. Thiiranes

Thiiranes, the simplest sulfur heterocycles, are useful from both theoretical and synthetic points of view. They are used in the pharmaceutical, polymer, pesticide and herbicide industries.¹⁴ A variety of methods have been developed for the preparation of thiiranes. Among them, the most important method is the conversion of oxiranes to thiiranes by an oxygen-sulfur exchange reaction. Zeynizadeh *et al.* reported a novel green protocol for solvent-free conversion of epoxides to thiiranes with Dowex-50WX8-supported thiourea. All reactions have been carried out either with classical heating or under microwave irradiation to give the corresponding thiiranes in 75–98% yields within 30 seconds to 120 minutes for deactivated epoxides (Scheme 4).¹⁵

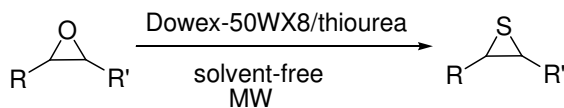

Scheme 4

2.2. Four-membered heterocycles with one heteroatom

2.2.1. β -Lactams

Azetidion-2-ones (β -lactams) are among the most investigated of all heterocyclic ring systems because of their well-documented impact on small-molecule drug discovery.^{16–18} Dandia *et al.* have developed the

facile synthesis of fused β -lactam benzothiazepine with a substituted-1,5-benzothiazepine and chloroacetyl chloride on potassium carbonate surface in few minutes and good yields (75–85%), under solvent free microwave conditions.¹⁹ The same reactions were also carried out conventionally in basic medium (triethylamine and dry benzene) and the product was obtained in lower yield (~20%) after a long reaction time (90 hours) (Scheme 5).

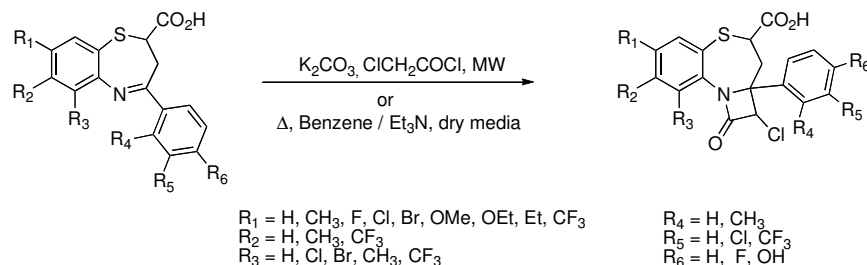

Scheme 5

More recently, Jiao *et al.* have described the origin of the relative stereoselectivity (*cis/trans* ratio) of the β -lactam formation in the Staudinger reaction under microwave irradiation.²⁰ The authors reported that *S*-phenyl 2-diazoethanethioate efficiently rearranged to phenylthioketene in dry toluene at 80 °C and gave, in the presence of imines, β -lactam derivatives in good yields (72–92%). They also reported that the microwave and photoirradiation could not obviously change the stereoselectivity outcome of the Staudinger reaction, in accordance with the result obtained under thermal conditions (Scheme 6).

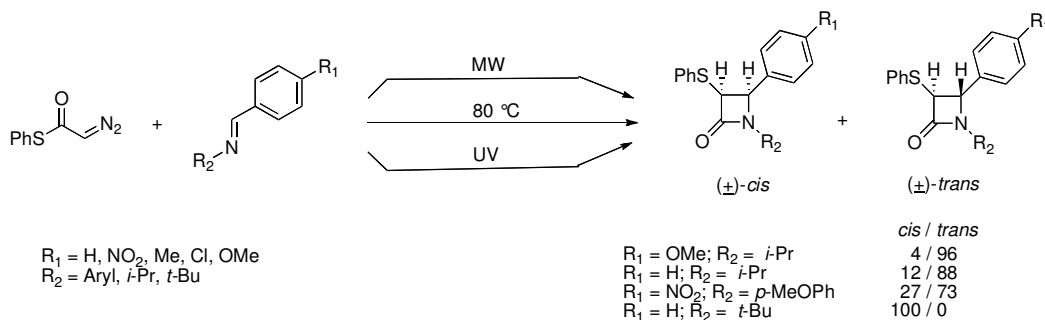

Scheme 6

2.3. Five-membered heterocycles with one heteroatom

2.3.1. Pyrroles, thiophenes and furanes

Pyrroles are important five-membered ring heterocycles in organic and medicinal chemistry because of their presence in a large number of natural products and bioactive compounds. In addition, pyrrole is also known as a biosynthetic precursor of many natural compounds and it is consequently used as a key intermediate in biomimetic total synthesis.

Minetto *et al.* described a three-step procedure for the synthesis of substituted pyrroles using microwave-assisted Paal-Knorr reaction as a key step (Scheme 7).²¹ The strategy comprises functional homologation of a β -ketoester with an aldehyde followed by oxidation (PCC), which gave a series of substituted 1,4-dicarbonyl compounds that can cyclize under microwave activation to functionalized pyrroles. The authors also described the application of this procedure for the synthesis of trisubstituted furans under acidic conditions (Scheme 7).

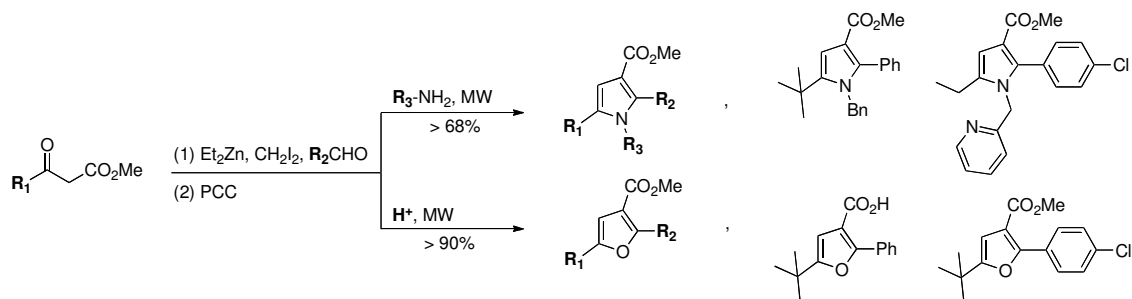

Scheme 7

Ngwerume *et al.* reported another approach based on nucleophilic catalysis for the synthesis of *di*-, *tri*- and *tetra*-substituted pyrroles.²² This interesting procedure, realized in one-pot and regioselective fashion, relies on nucleophilic catalysis of the intramolecular addition of oximes to alkynes followed by thermal rearrangement of the *in situ* generated *O*-vinyl oximes to give pyrroles (Scheme 8).

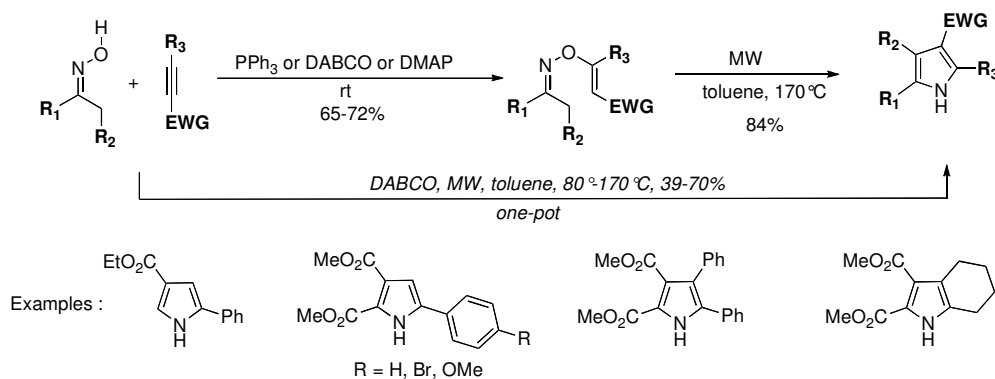

Scheme 8

Tetra-substituted furanes can also be efficiently obtained using multicomponent reactions under microwave irradiation. Bremner *et al.* reported a multicomponent continuous flow approach that involved a condensation of aldehydes, cyclohexyl isocyanide and dimethyl acetylenedicarboxylate (DMAD) to produce *tetra*-substituted furanes (Scheme 9).²³ It is noteworthy that this transformation required 2–9 hours under classical thermal conditions and led to modest yields whereas under microwave irradiation reactions were achieved in few seconds and high yields, in a flowed format.

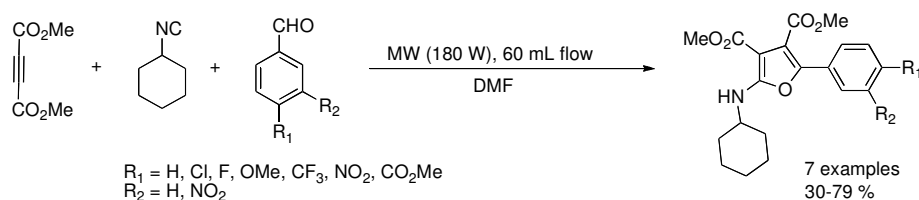

Scheme 9

An interesting microwave-assisted parallel synthesis of thiophenes and fused heterocycles in a multimode reactor was recently reported by Treu *et al.*²⁴ In this study, substituted 2-aminothiophenes were synthesized using Gewald reaction by condensation of ketones and nitriles in the presence of elemental sulfur (Scheme 10). Following Gewald procedure, a mixture of ketone, activated nitrile and elemental sulfur was heated at 120 °C for 10 minutes in EtOH and in the presence of morpholine as organic base. This

process gave a direct access to a small library of substituted 2-aminothiophenes with moderate to good yields (22–87%). Reactions were then carried out in a multimode instrument (Synthos 3000) using simultaneous multiple parallel synthesis methodology.

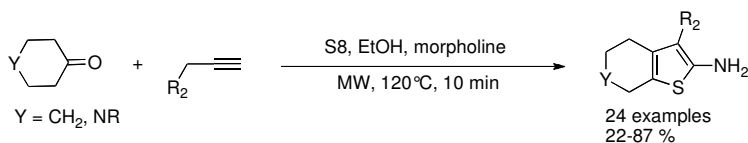

Scheme 10

2.3.2. Indoles, benzofurans and benzothiophenes

The indole nucleus is a structural scaffold found in a vast number of alkaloid natural products and biologically active molecules. The synthesis and modular functionalization of indole compounds have been extensively studied. Fischer²⁵ and Bischler-Möhlau²⁶ procedures remain the most classically used methods for the preparation of indole derivatives (Scheme 11a and 11c). An elegant Fischer-modified approach was reported by Buchwald using Pd-catalyzed *N*-arylation of halobenzene as a key step followed by acid-promoted cyclization (Scheme 11b).²⁷ Recently, several reports described new and efficient strategies based on palladium-catalyzed tandem or sequential Sonogashira coupling/benzannulation of *o*-haloaniline (Scheme 11d).²⁸

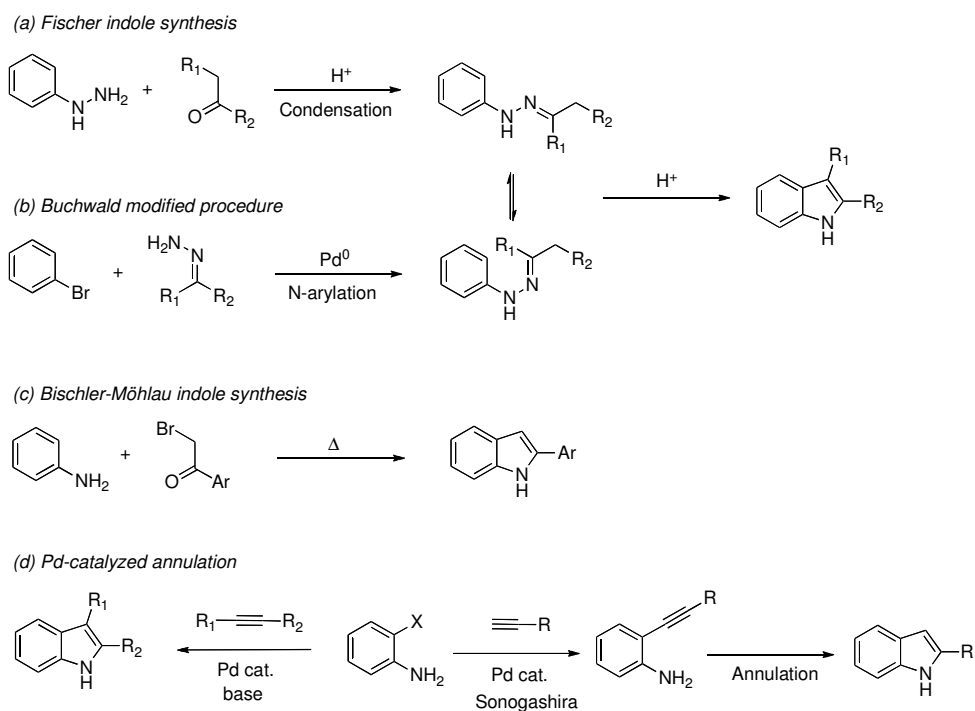

Scheme 11

Because some of these reactions required thermal energy to make the process more efficient, the microwave technology seems to be ideal in this case for temperature and pressure control and to elevate the reaction rate and increase the selectivity. Therefore, different examples were recently reported for the synthesis of indole derivatives under microwave activation.^{29a} For example, the Bischler reaction involving substituted anilines and bromoacetophenones was applied under microwave irradiation to give 2-arylindoles in good yields (Scheme 12).^{29b} DMF was used in this reaction to improve the energy transfer.

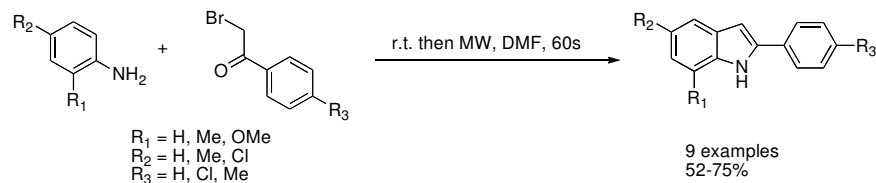

Scheme 12

Hemetsberger-Knittel indole synthesis has been recently developed under microwave activation.³⁰ In this work, thermal rearrangement of α -azidocinnamates gave the corresponding substituted indoles *via* the instable nitrene intermediate (Scheme 13). Indeed, α -azidocinnamates were heated in hexane at 200 °C for 10 minutes under microwave irradiation in closed-vessels to afford excellent yields of substituted indoles, without formation of side products.

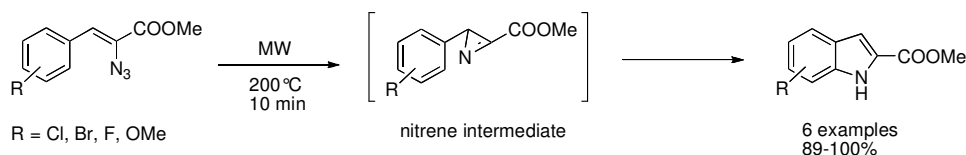

Scheme 13

Substituted indoles were also synthesized using cycloaddition/cyclization sequence from (*Z*)-1-methoxybut-1-en-3-yne and 2*H*-pyran-2-ones under microwave irradiation (Scheme 14).³¹ The Diels-Alder reaction between substituted 3-acylamino-2*H*-pyran-2-ones (diene) and 1-methoxybut-1-en-3-yne (dienophile) afforded, after a short microwave irradiation time, the cycloadducts **C1** with a complete regioselectivity. However, electron-rich pyranones ($R_2=4\text{-MeOPh}$, $R_3=\text{Me}$; $R_2=\text{H}$, $R_3=\text{Me}$) did not react even after prolonged irradiation times, which is in accordance with an inverse electron demand cycloaddition. Furthermore, the authors observed that the chemo- and regioselectivity of the cycloaddition might be controlled by the electron-donating properties of the methoxy group of the triple bond of the en-yne. It is worth noting that under high-pressure conditions (13–15 kbar) and without microwave activation, the cycloaddition led to compounds **C2**. Indole derivatives were then obtained in 69–84 % yields from both **C1** and **C2** under acidic conditions using microwave irradiation.

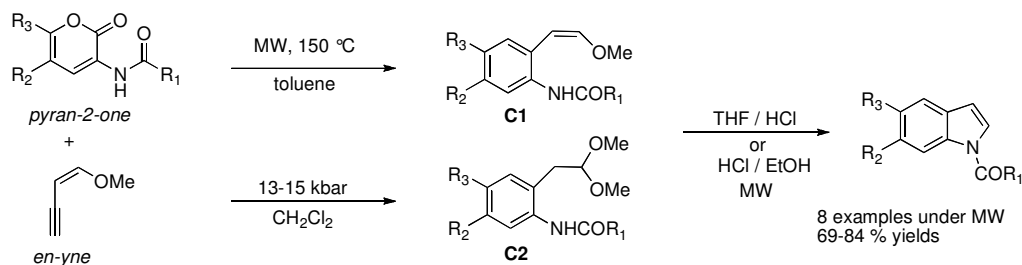

Scheme 14

Kraus *et al.* explored a new synthetic approach to 2-substituted indoles from 2-aminobenzyl phosphonium salts (Scheme 15).³² Indeed, the reaction of (2-aminobenzyl) triphenylphosphonium bromide with aromatic aldehydes or α,β -unsaturated aldehydes under microwave-assisted conditions led to 2-substituted indoles in 81–95 % yields. This methodology was then applied for the synthesis of the natural product Arcyriacyanin A that was obtained in two steps and 35% overall yield.

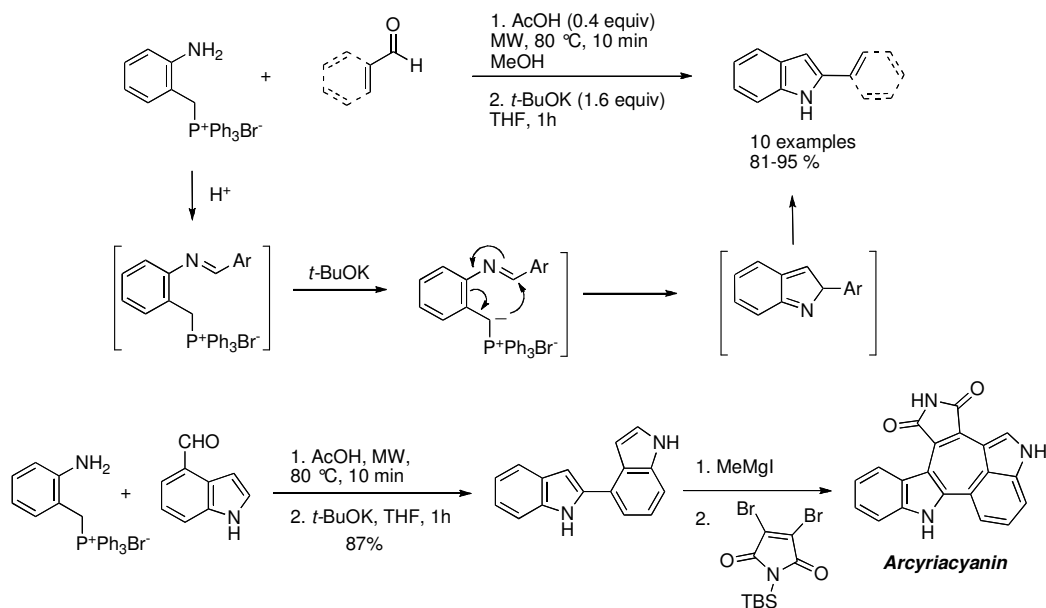

Scheme 15

The activation of Fischer indole synthesis using microwave technology was reported by Lipinska *et al.* (Scheme 16a).³³ They used triethylene glycol (TEG) and catalytic quantity of ZnCl_2 that allowed efficient transformation of 3-acetyl-1-methylthiocycloalka[*c*]pyridine phenylhydrazones and *p*-methoxyphenylhydrazones into 2-(2-pyridyl)indoles and 5-methoxy-2-(2-pyridyl)indoles, which are advanced intermediates in total synthesis of antitumor sempervirine-type alkaloids. Different conditions were surveyed under microwave activation including MK10/ ZnCl_2 , MW, solvent free; MK10/ ZnCl_2 , MW, TEG and ZnCl_2 , MW, TEG. The best results were obtained using method 3, *i.e.*, ZnCl_2 , MW, TEG that gave good yields of substituted indole products. The effect of ZnCl_2 , TEG and microwave activation were clearly evidenced since cationic transition states were expected in this case and were found to be highly favoured under microwave irradiation.

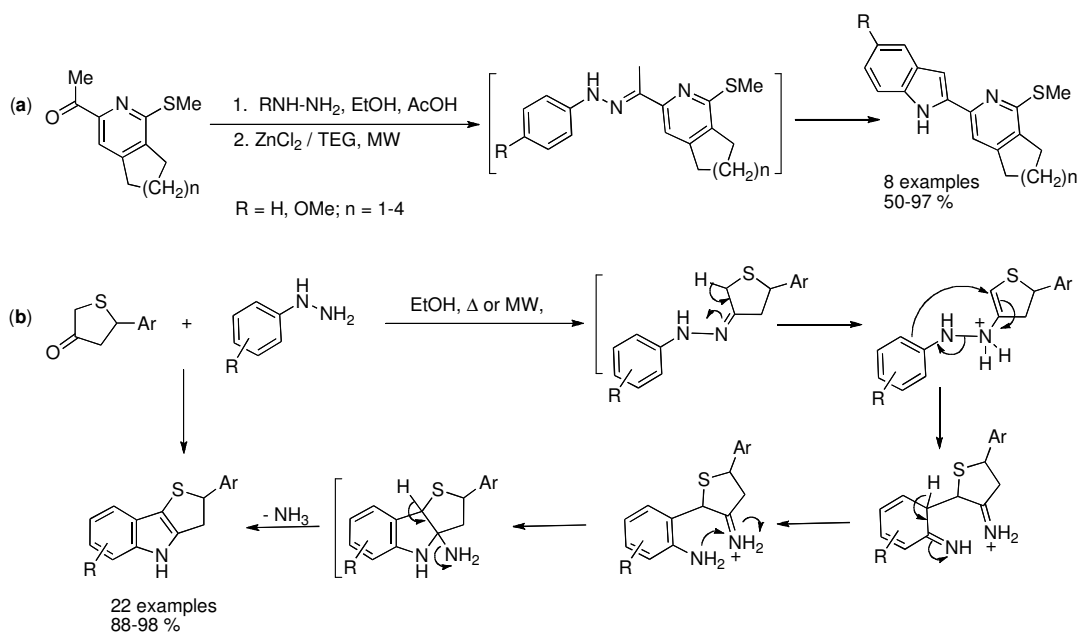

Scheme 16

Another example of Fischer indole synthesis was also developed by Karthikeyan *et al.* for the preparation of antitubercular 2-aryl-3,4-dihydro-2*H*-thieno[3,2-*b*]indoles (Scheme 16b).³⁴ The synthesis involved the condensation of 5-aryldihydro-3(2*H*)-thiophenones and arylhydrazine hydrochloride and it was found to be assisted by microwaves and furnished excellent yields (85–98%). This new series of thienoindole derivatives was screened for their *in vitro* antimycobacterial activity (MTB). Some of these compounds were found to display good antimycobacterial activity against normal MTB and resistant MDR-TB lines. The indole derivative (2-(2,4-dichlorophenyl)-7-fluoro-3,4-dihydro-2*H*-thieno[3,2-*b*]indole) was found to be the most active *in vitro* with an MIC=0.4 mg/mL (minimal inhibitory concentration) against MTB, more potent than the classical ethambutol and pyrazinamide drugs.

An efficient and elegant one-pot synthesis of a variety of substituted indole has been recently reported by Larock under microwave-assisted conditions (Scheme 17).³⁵ The synthesis was carried out in two steps and involved Sonogashira coupling between substituted 2-iodoanilines and terminal alkynes, followed by the addition of acetonitrile and an aryl iodide. In this reported work, the process was found to be dramatically accelerated under microwave irradiation compared to conventional heating. The authors also observed that the Sonogashira step was more efficient with electron-rich aryl- than electron-poor aryl-acetylenes whereas the iodoaniline partners did not electronically affect this coupling. The proposed mechanism of this one-pot two-step process is shown in Scheme 17. It started with the coordination of **A** triple bond by Ar-Pd-I to form a π -palladium complex **B** which undergoes *trans*-aminopalladation (*5-endo-dig* cyclization, **B** to **C**) followed by sequential I⁻-assisted Me-removal (S_N2) and reductive elimination leading to substituted indole products.

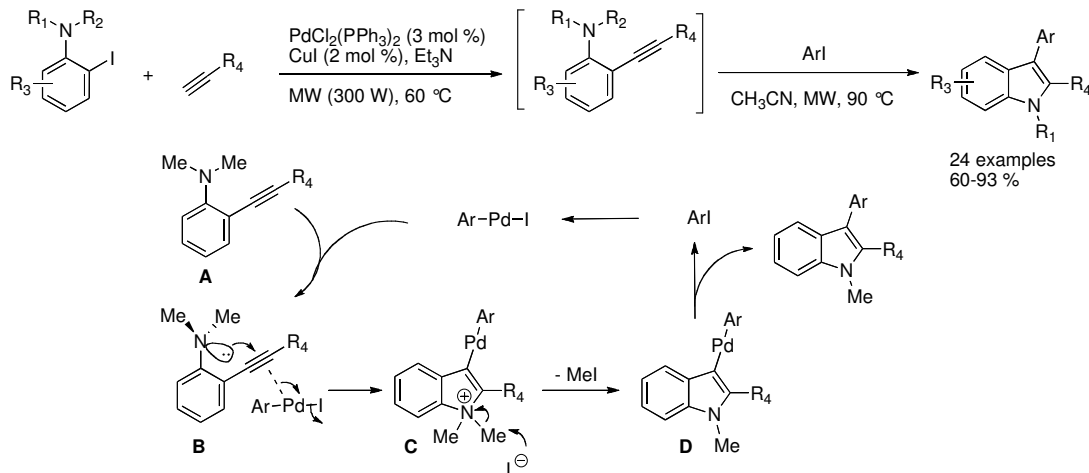

Scheme 17

A similar approach was reported by Carpita *et al.* using cycloisomerization of 2-alkylanilines under green and sustainable conditions.³⁶ Indeed, 2-alkylanilines underwent thermal rearrangement at 200 °C in water and under catalyst-free microwave irradiation to give substituted indoles in moderate to good yields (Scheme 18). Higher yields were obtained for anilines bearing electron-donating substituents.

An interesting microwave-assisted intramolecular furan-Diels-Alder approach was reported in 2010 by Wipf for the synthesis of 4-substituted indoles (Scheme 19).³⁷ The homoallylic furanyl amines were first synthesized by aldol condensation between lithiated furane and α,β -unsaturated carbonyl compounds and then subjected to microwave irradiation in *o*-dichlorobenzene at 180 °C. It is worth noting that no reaction

took place under conventional heating while under microwave irradiation the same reaction gave high yields of the desired 4-substituted indoles, presumably according to the mechanism shown in Scheme 19.

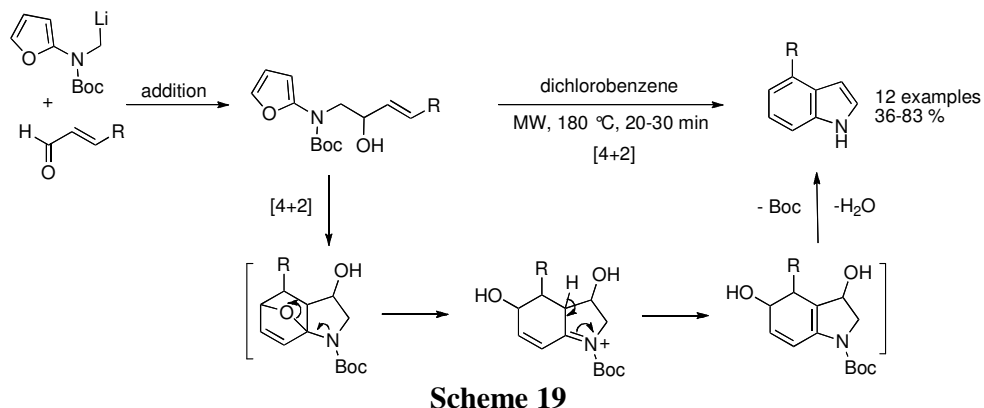
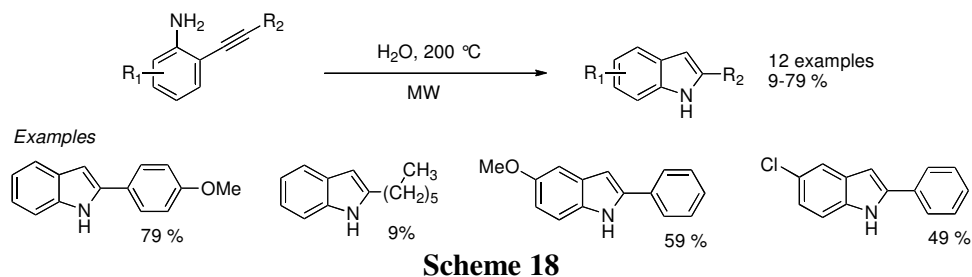

Benzothiophenes and benzofurans can be efficiently obtained in reasonable yields using a microwave-assisted one-pot cyclization-Suzuki approach.³⁸ Two routes were reported by DiMauro *et al.* and these are given in Scheme 20. The first route (A) started with 5-bromo-2-fluoro benzaldehyde and involved Pd-catalyzed boronation followed by microwave-assisted/base-promoted S_NAr substitution-cyclization, in the presence of substituted alcohol or thiol derivatives ($HY-CH_2-R_1$), to give benzofuran or benzothiophene derivatives, respectively. In the second route (B), the three steps were achieved under microwave irradiation and afforded substituted benzofurans in 33–72% yields.

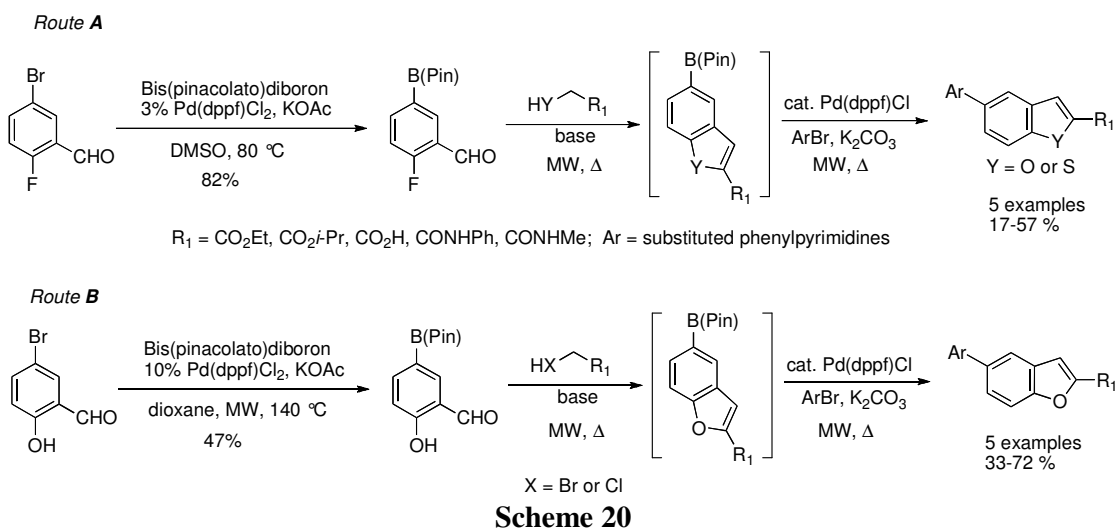

The preparation of substituted benzothiophenes and benzofurans can also be achieved by acid-catalyzed benzannulation of *ortho*-OMe- or SME-arylalkynes under microwave irradiation. Briand and Alami

recently reported a series of compounds using *p*-toluenesulfonic acid (PTSA) as catalyst in EtOH (Scheme 21).³⁹ The outcome of the reaction (ketones *vs* benzofuran or benzothiophene) could be controlled by simple control of the reaction conditions and the nature of the aryl group. Under refluxing EtOH, electron-rich aliphatic arylalkynes are regioselectively hydrated using a catalytic amount of PTSA to provide carbonyl compounds. In contrast to conventional conditions, under optimized microwave heating, diarylalkynes bearing on the *ortho* position an OMe or a SMe substituent underwent an electrophilic cyclization to produce a variety of benzofuran and benzothiophene derivatives. The proposed mechanism probably involved a *5-endo-dig* cyclization as the key step followed by displacement of the methyl group by EtOH at high temperature (Scheme 21).

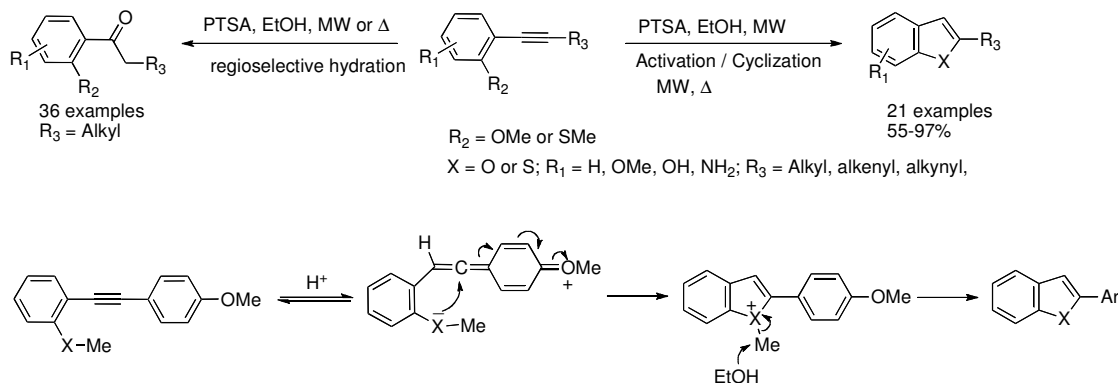

Scheme 21

2.4. Five-membered heterocycles with two heteroatoms

The synthesis of functionalized imidazoles and pyrazoles is obviously an important task in modern medicinal chemistry and drug discovery. Some of them constitute an important part of a number of bioactive molecules. For example, AICAR (5-aminoimidazole carboxamide riboside) is a natural metabolite involved in the *in vivo* adenine and guanine nucleotide pool synthesis (Scheme 22).⁴⁰ It is a potent AMP-activated protein kinase activator used for the treatment of acute lymphoblastic leukemia and other diseases such as diabetes, cardiovascular and cerebrovascular complications and other metabolic disorders.⁴¹ Oroidin and analogues are marine natural products with promising pharmacological properties.⁴² Pyrazoles are well-known for their applications in agrochemical industry due to their large spectrum of activity. Among them, fripronil,⁴³ topramezone⁴⁴ and other analogues are potent drugs routinely used and marketed as pesticides. Pyrazomycin is a pyrazole antibiotic produced by the fermentation of *Streptomyces candidus* NRRL 3601, endowed with antiviral and antifungal activities (Scheme 22).⁴⁵

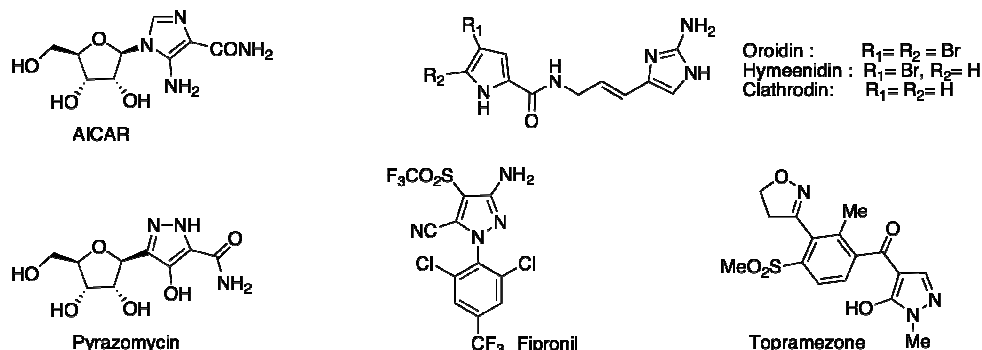

Scheme 22

2.4.1. Imidazoles

Several methods were reported for the synthesis of imidazoles under microwave activation. Sparks *et al.* described the synthesis of 2,4,5-triarylimidazoles from reaction of keto-oximes and aldehydes followed by cyclization of the *N*-hydroxyimidazoles intermediates and *in situ* thermal reduction of N–O bond upon microwave irradiation (Scheme 23).⁴⁶ Compared to conventional heating, the desired products were obtained in near quantitative yields and within a short reaction time (20 minutes) compared to two days, respectively. The authors also reported the synthesis of a small library of triarylimidazoles using automated microwave-synthesis and preparative HPLC purification by applying the same methodology. In this approach, AcOH was found to be the best solvent that gave high conversion rate.

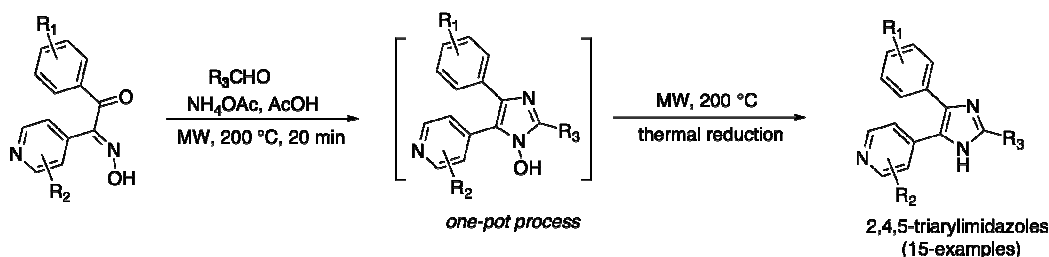

Wolkenberg *et al.* also reported similar approach for the synthesis of trisubstituted imidazoles from 1,2-diketones and aldehydes in the presence of NH_4OAc , under microwave activation (Scheme 24).⁴⁷ Reactions were conducted in AcOH and delivered high yields of the 2,4,5-substituted imidazoles (80–99%) within a short reaction time, from 0.5 to 5 minutes. This approach was found to be general and tolerates a range of substrates including aliphatic, aromatic aldehydes and those bearing either electron-withdrawing or electron-donating groups. This efficient methodology was also applied for the synthesis of Lepidiline B natural product and Trifenagrel, a potent arachidonate cyclooxygenase inhibitor.

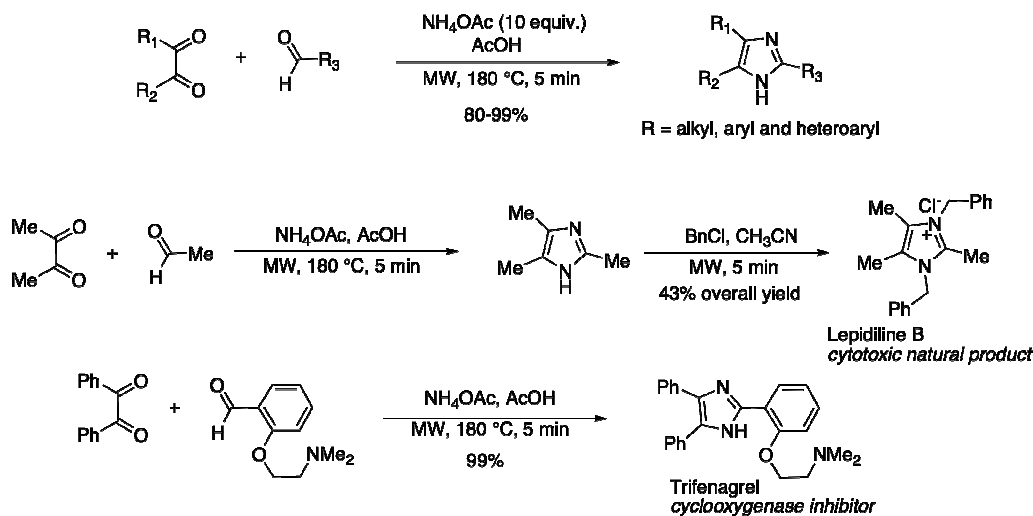

Babaev *et al.* reported another one-pot, two-step protocol for the synthesis of polysubstituted 2-aminoimidazoles.⁴⁸ The process involved the microwave-assisted sequential condensation of 2-aminopyrimidines and α -bromocarbonyl derivatives to afford imidazo[1,2- α]pyridinium salts followed by opening of the

pyrimidine ring with hydrazine (Scheme 25). The first step was performed at 150–180 °C with 1.35 equivalents of α -bromoketones to give the pyridinium salt intermediates. Interestingly, the control of the reaction temperature led to the selective formation of the dehydrated aromatic intermediate ($-\text{H}_2\text{O}$). Then, treatment of this intermediate in the presence of hydrazine (60%, 5 equiv.) under microwave irradiation afforded the desired 2-aminoimidazoles in good to excellent yields. In these reported examples, microwave activation was found to give high yields and faster reactions (15 minutes) compared to the conventional heating (10–12 hours).

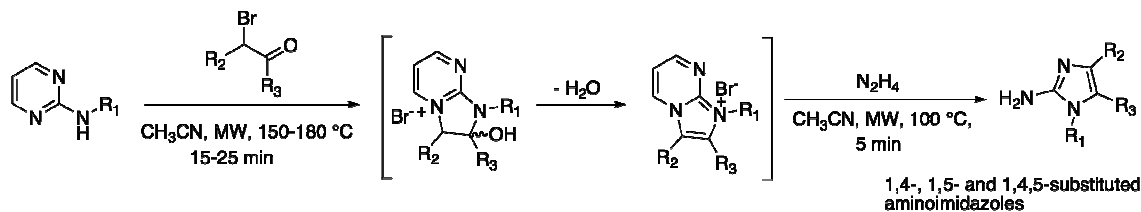

Scheme 25

2.4.2. Pyrazoles

A number of interesting examples were reported for the synthesis of functionalized pyrazoles under microwave activation. Weinreb amide was reported to react with the lithium or sodium salt of ethyl propionate in acyl substitution-conjugate addition sequence to give (*E*)-*N*-methoxy-*N*-methyl- β -enamino-ketoesters (Scheme 26).⁴⁹ These intermediates undergo regioselective cyclocondensation with hydrazines under microwave irradiation to afford 1,3,5-trisubstituted pyrazoles in moderate to excellent yields (42 to 94%). It was found that Weinreb amides with bulky substituents such as $R = \textit{tert}$ -butyl and 2,4-dimethoxyphenyl did not react in the first step suggesting a steric effect. Stereoelectronic contribution of R_1 group was also observed and was found to be important for the regiochemical outcome of the reaction. For example, aryl groups directed the conjugate addition to the β -position of the ketone.

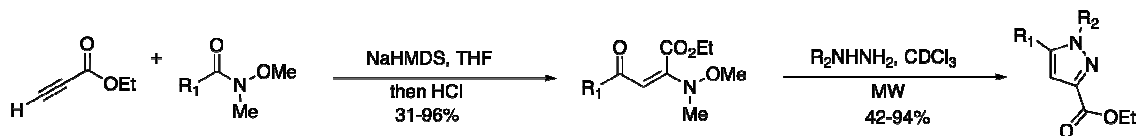

Scheme 26

3,5-Dimethylpyrazoles were also obtained using the condensation of acetylacetone and 2-hydrazinobenzothiazole under solvent-free and microwave activation (Scheme 27).⁵⁰ Under microwave irradiation, the cycloaddition was efficient since the cycloadduct was obtained after 1 minute at 130 °C in 90% yield. In contrast, under conventional heating, the product was obtained in 65% after 3 hours.

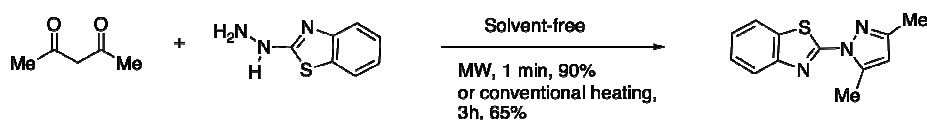

Scheme 27

An elegant one-pot, multicomponent route to pyrazoloquinolinone was recently reported by Kappe (Scheme 28).⁵¹ The synthesis involved the condensation of three components, 5-aminopyrazoles, aromatic

aldehydes and cyclic 1,3-diketones under strongly basic conditions and controlled microwave heating. It is worth noting that the outcome of this three-component reaction is highly depending on the nature of substrates and the experimental conditions. For example, the authors observed that, under classical heating, a three-component condensation of cyclic 1,3-diketones, aldehydes and 3-methyl-5-aminopyrazole afforded exclusively pyrazoloquinolinones **A**, whereas 3-aryl substituted 5-aminopyrazoles gave a mixture of pyrazoloquinolinones **B** and pyrazoloquinazolinones **C**. In contrast to conventional heating, under microwave activation, the same reaction afforded a novel series of compounds, assigned as pyrazolo[4,3-*c*]quinolizin-9-ones (**D**). Based on experimental investigations (methods A–D), the proposed mechanism of this interesting approach is depicted in Scheme 29. The process involved the initial base-catalyzed formation of Michael adduct **I1** which, in the presence of aminopyrazole, afforded the tricyclic intermediate **I2**. Then, dehydration from **I2** may afford pyrazoloquinolinones **B**, whereas sequential addition/elimination of EtO^- , involving intermediate **I3** and **I4**, should explain the formation of pyrazolo[4,3-*c*]quinolizin-9-ones **D**.

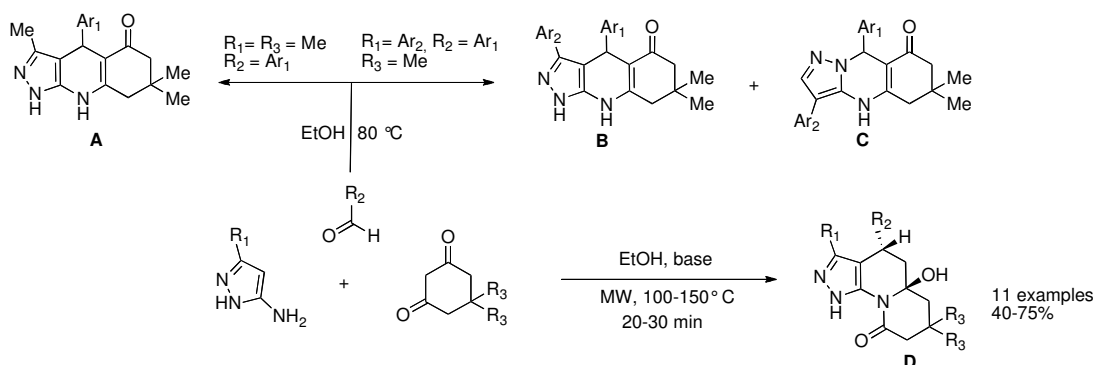

Method A (one pot, one step procedure): Amine: diketone: aldehyde (1:1:1), KOH, EtOH, MW, 150 °C, 25 min
Method B (one pot, one step procedure): Amine: diketone: aldehyde (1:2:1), EtONa, EtOH, MW, 150 °C, 20 min
Method C (one pot, two step procedure): diketone: aldehyde (2:1), EtONa, EtOH, MW, 100 °C, 2 min then amine (1 equiv), MW 15 min
Method D (one pot, two step procedure): Amine: diketone (1:1), EtONa, EtOH, MW, 150 °C, 10 min, then aldehyde (1 equiv), MW 10 min

Scheme 28

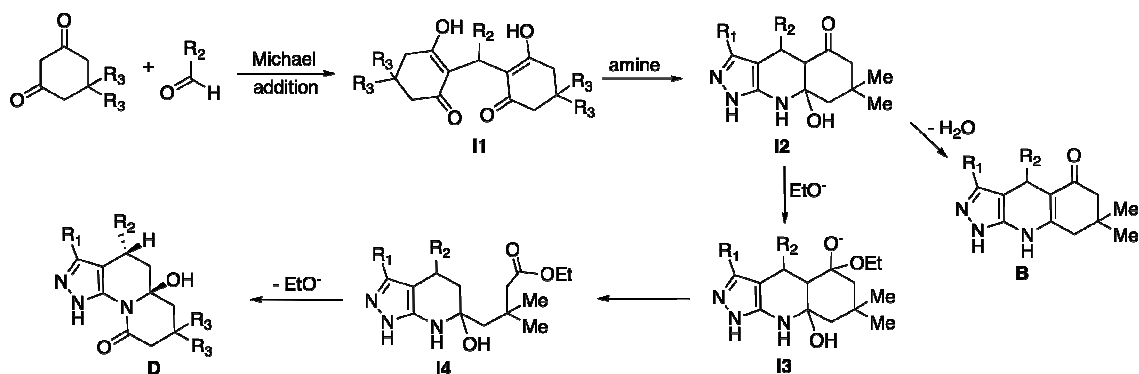

Scheme 29

2.4.3. Oxazoles and isoxazoles

Oxazoles can be obtained from condensation of amides or nitriles with activated α -ODNs-substituted ketone intermediates, prepared *in situ* by reaction of hypervalent iodine sulfonate with ketones (Scheme 30).⁵² The reaction was carried out using microwave irradiation of a mixture of ketone (1 mmol) and HDNIB (hydroxy-(2,4-dinitrobenzenesulfonyloxy)iodo- benzene, 1.2 mmol) followed by addition of amide. The formation of trisubstituted oxazoles was highly efficient since only few minutes are required to achieve complete conversion and high yields (63–94% yields in 1 to 3 minutes for two steps).

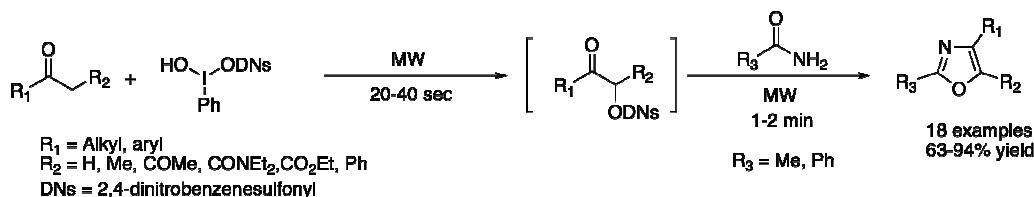

Scheme 30

Amino-oxazoles containing compounds are of great interest because of their high therapeutic potential in a number of diseases.⁵³ The microwave-assisted Cornforth rearrangement was reported by Nolt *et al.* for the synthesis of substituted 5-amino-oxazoles (Scheme 31).⁵⁴

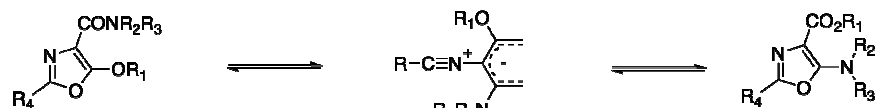

Scheme 31

The synthesis, outlined in Scheme 32, comprises: (i) cyclodehydration of benzoyl-2-amino diethyl malonate and saponification to give the oxazolyl-acid, (ii) amide coupling under microwave irradiation led to the Cornforth substrate, which under (iii) thermal rearrangement produced the 5-amino-oxazole-4-carboxylate. The amide coupling and Cornforth rearrangement were carried out in one step under microwave-optimized conditions (coupling at 100 °C for 5 minutes and thermal rearrangement at 180 °C for 5 minutes in trifluorotoluene as solvent) and afforded moderate to excellent yield depending on the nature of the starting material.

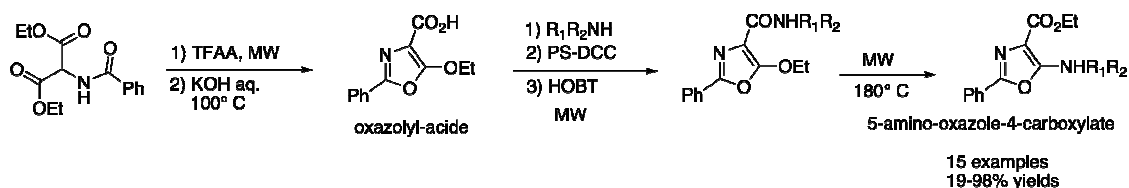

Scheme 32

We have previously reported an efficient one-step regioselective synthesis of novel isoxazolines and isoxazoles of *N*-substituted saccharin derivatives using a solvent-free microwave-assisted [3+2] cycloaddition reaction involving nitrile oxide and *N*-allyl or *N*-propargyl saccharines.⁵⁵ Nitrile oxides were generated *in situ* from aldoximes using *N*-chlorosuccinimide impregnated alumina. The condensation reaction was performed under microwave irradiation with *N*-allyl or *N*-propargyl saccharines at 110–150 °C to afford the desired isoxazoles. The effect of microwave activation was clearly evident since the targeted molecules were obtained in 81–95% yield after 3 minutes instead of 12–45% after 5 hours of reaction time under classical heating (Scheme 33).

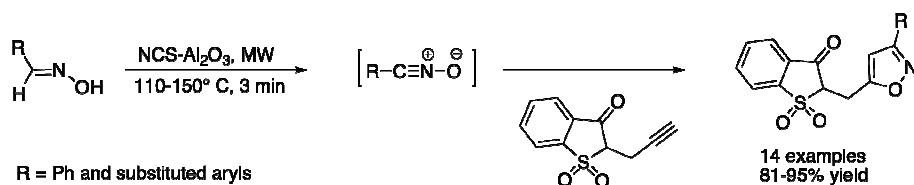

Scheme 33

An interesting comparative study between conventional, microwave-assisted and flow-based methodologies was recently reported by Castellano *et al.* for the synthesis of substituted pyrrolo-isoxazole derivatives by means of 1,3-dipolar cycloaddition (Scheme 34).⁵⁶ The authors showed that under conventional heating, the reaction proceeded very slowly (7 days) with low yields. In contrast, microwave irradiation resulted in increased yields and accelerated reactions, even with poorly reactive dipoles (1.5 hours). Interestingly, by applying a flow chemistry approach (Scheme 34) the reaction time was further decreased to 10 minutes and the yield additionally increased. Furthermore, running the flow chemistry instrument for a longer time allowed the scale up of the process, making the methodology more attractive for the synthesis of such analogues.

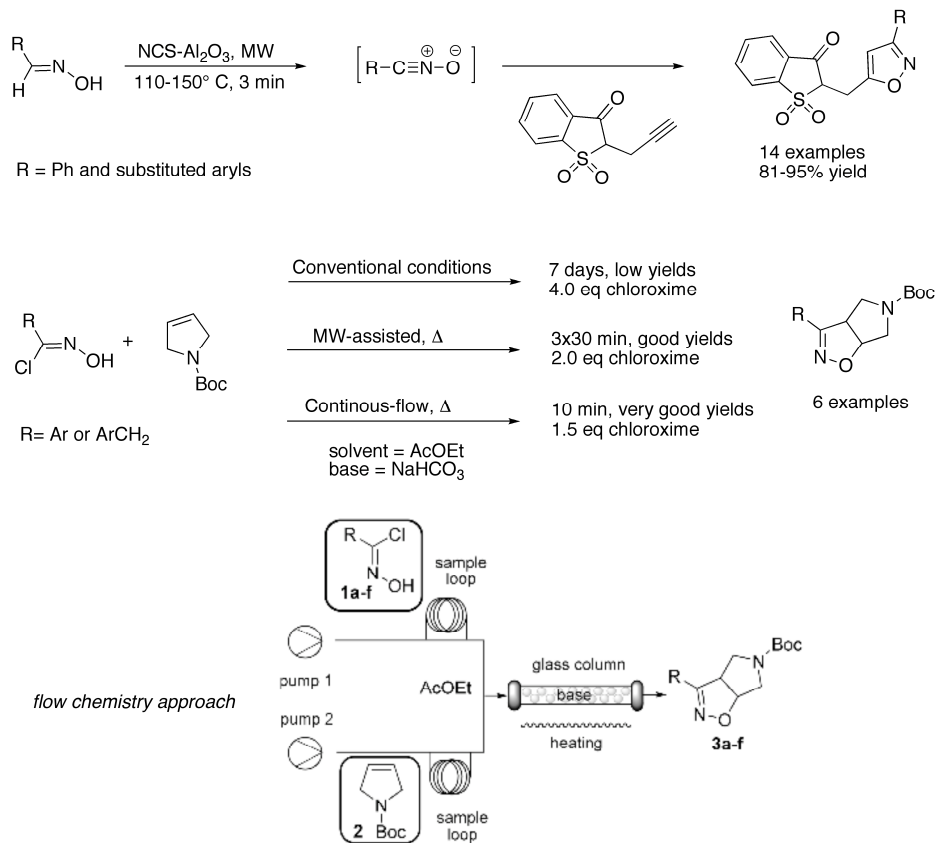

Scheme 34

2.4.4. Thiazoles

Thiazoles and thiazolidines can be obtained by condensation of cysteine with aldehydes or acids under microwave activation. For example, treatment of L-cysteine ethyl ester with different aldehydes in the presence of potassium bicarbonate afforded the corresponding thiazolidines as a mixture of two diastereomers (Scheme 35).⁵⁷

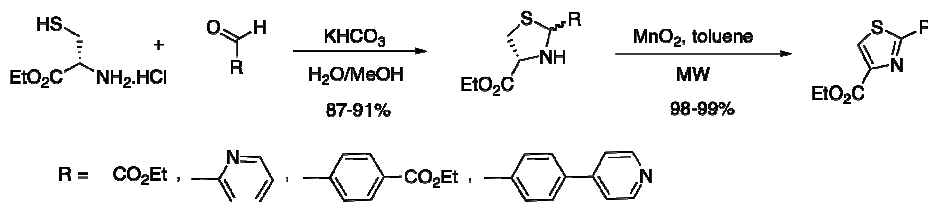

Scheme 35

These intermediates were then converted to the corresponding thiazoles *via* microwave-assisted oxidative dehydrogenation. In this approach, when 5 equivalents of MnO₂ were used, only 30 seconds of irradiation (100 °C and 400 W) was necessary to achieve complete and quantitative conversion of thiazolidines to thiazoles. It is noteworthy that, in contrast to conventional heating, the addition of base is not necessary under microwave activation avoiding therefore the racemization of thiazolidine products. This methodology was also applied for the synthesis of oxazoles from serine aminoacid.

Conversion of steroidal ketones to their corresponding thiazoles was reported using iodine and thiourea (Scheme 36).⁵⁸ In this work, a mixture of ketone, phenylthiourea and iodine (1:1:2) was adsorbed on neutral alumina using isopropanol (1 mL). Microwave irradiation of this mixture for 3–5 minutes at 325 W (50% of power) led to the corresponding steroidal thiazoles in good yields. Two mechanisms were proposed for this reaction, *i.e.*, α -iodination of the ketone followed by allylic rearrangement or 1,3-shift from the enol intermediate and subsequent cyclization.

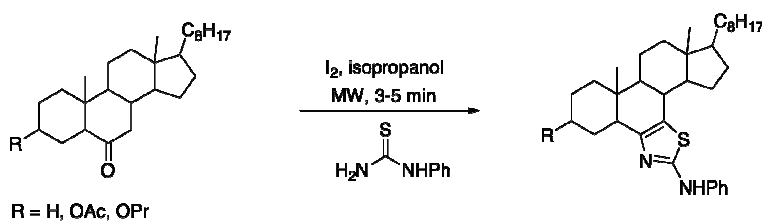

Scheme 36

A domino alkylation-cyclization approach was reported for the synthesis of 2-aminothiazoles (Scheme 26).⁵⁹ Propargylbromide reacted with thiourea at 130 °C, in the presence of potassium carbonate (1 equiv.) under microwave irradiation (10 minutes) to afford the corresponding 2-aminothiazoles in good to excellent yields. The proposed mechanism started by the alkylation of thiourea to give the intermediates **I1** or **I2**, followed by 5-*exo-dig* cyclization on the triple bond and isomerization to the thiazole products (Scheme 37). Starting from the fact that the isomerization of the triple bond into allene generally requires strong bases (*t*-BuOK or EtONa), cyclization from **I1** was privileged by the authors.

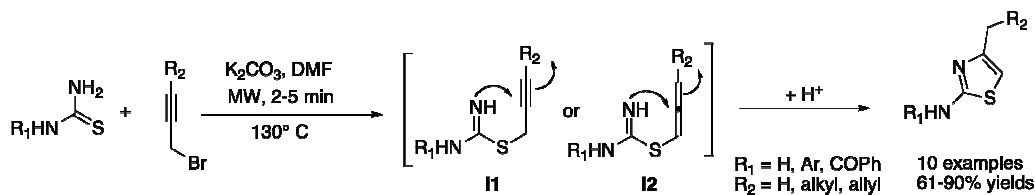

Scheme 37

An interesting approach for the synthesis of thiazoles and their thiopeptide analogues was reported by Kazmaier and Ackermann *via* Ugi multicomponent reaction.⁶⁰ The use of thio-acids as components allowed access to the corresponding endopeptides and some of them were converted into thiazoles using TMSCl-NaI under microwave irradiation (Scheme 38).

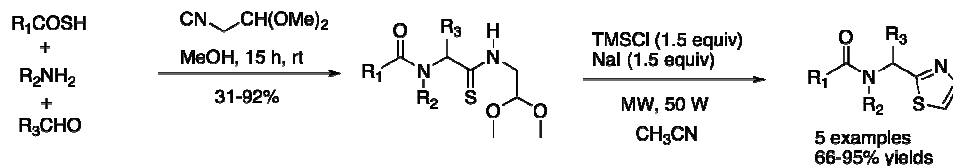

Scheme 38

Under conventional conditions, the conversion of thiazoline intermediate to thiazole was found to be problematic whereas the use of microwave activation led to high conversion rates and good yields, after only 10 minutes of irradiation.

2.4.5. Benzimidazoles, benzoxazoles and benzothiazoles

Substituted benzimidazoles, benzoxazoles and benzothiazoles are interesting pharmacophores in medicinal chemistry since they are well known to exhibit a broad range of biological activities.⁶¹ They have shown numerous biological activities such as antimycobacterial,⁶² elastase inhibitors,⁶³ and H₂-antagonists.⁶⁴ They were also used as advanced materials including organic light-emitting diodes⁶⁵ and liquid crystals.⁶⁶ For example, compound **A** (Hoechst 33258, Scheme 39) is a fluorescent reagent with head-to-tail *bis*-benzimidazole structure, initially found to be active against murine leukemia. It is well-known as double strand DNA minor groove binder at adenine-thymine rich sequences.⁶⁷ Benzimidazole **B** has been shown to have potent activity against a serine/threonine kinase Nek2, a new biological target in cancer chemotherapy.⁶⁸ Benzothiazolo-benzimidazole salts of type **C** were recently studied as significant PI3K/AKT (phosphatidylinositol-3-kinase/protein kinase B) inhibitors (Scheme 39).⁶⁹

Benzoxazoles are also an important class of heterocyclic systems found in a number of natural products and they are classically used in medicinal chemistry and drug discovery. For example, Caboxamycin (**D**, Scheme 39) is a new antibiotic of the benzoxazole family isolated from the marine strain *Streptomyces sp.* NTK 937. It showed inhibitory activity against Gram-positive bacteria and other tumor cell lines.⁷⁰ 2-(2'-Hydroxy-5'-aminophenyl)-benzoxazole (**E**) is an interesting fluorescent benzoxazole which exhibited antibacterial and antifungal properties.⁷¹ Pseudopteroxazole is another natural product highly studied for its potent antimycobacterial activity.⁷² Nakijinol B (**G**) and its acetylated derivative, Nakijinol B diacetate (R₁=R₂=Ac) are sesquiterpene benzoxazole natural products recently isolated from the methanol extract of the marine sponge *Dactylospongia elegans* and have been shown to exhibit interesting biological properties against various human tumor cell lines.⁷³

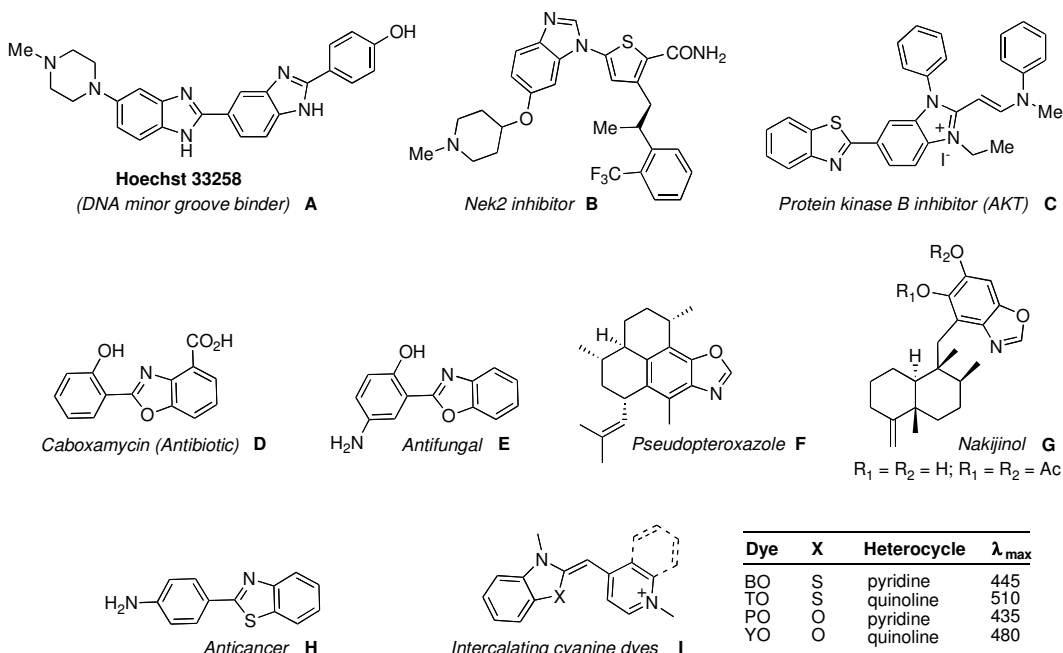

Scheme 39

2-(4-Aminophenyl)benzothiazole **H** was reported to have anticancer activity against various cancers including breast, colon and ovarian cell lines, probably by the formation of reactive intermediates that can bind covalently to endogenous nucleic acids.⁷⁴ Cyanine dyes of type **I** are interesting fluorescent compounds that bind DNA in the minor groove. They were studied as ratiometric dyes and characterized by their large increase in fluorescence intensity and quantum yield upon binding to DNA (Scheme 39).⁷⁵

Different routes have been reported for the synthesis of benzimidazoles, benzoxazoles and benzothiazoles including the direct condensation of *ortho*-disubstituted derivatives with carboxylic acid, transition metal-catalyzed intramolecular *ortho*-arylation, intermolecular domino annulations, etc. These methods generally required the presence of strong acid or additives and high reaction temperature.⁷⁶ Therefore, a number of recent procedures were reported for the activation of such reactions under microwave irradiation.

For example, Wang *et al.* reported an efficient one-step synthesis of benzimidazoles and benzoxazoles by condensation of carboxylic acids with 1,2-phenylenediamines or 2-aminophenols, respectively (Scheme 40).⁷⁷ They used a commercially available PS-PPh₃ resin and microwave heating at 150 °C in acetonitrile for 15 minutes. Both aryl and alkyl acids reacted efficiently and afforded high yields of the corresponding benzimidazole and benzoxazole cyclized products. Microwave irradiation has been previously applied in these condensation reactions by our group.^{76k,l}

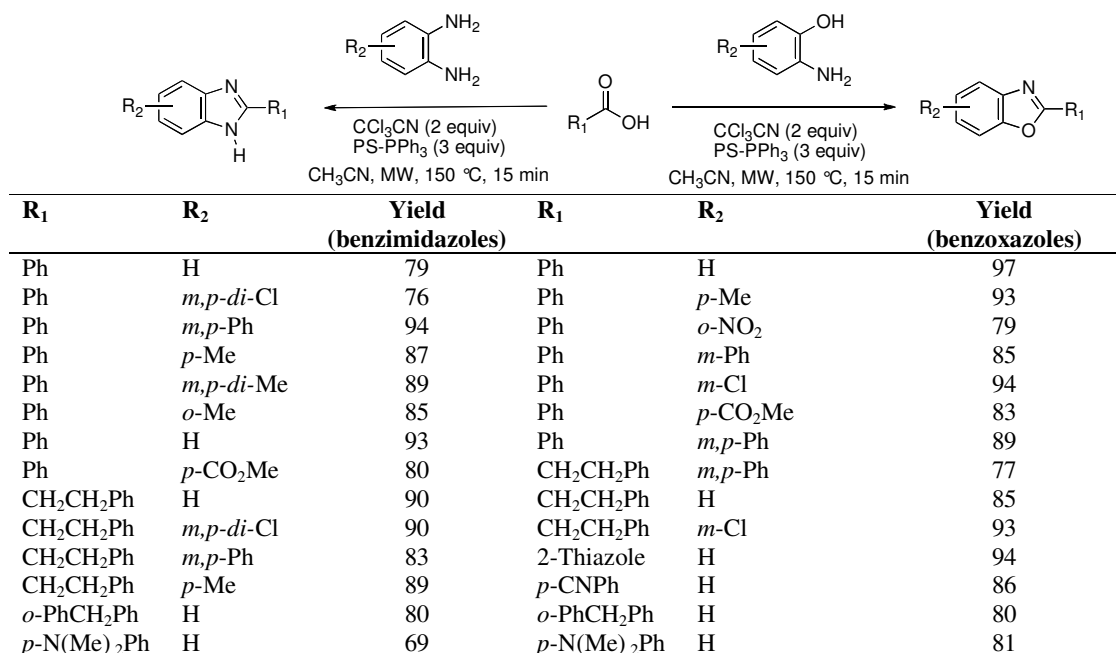

Scheme 40

Chanda *et al.* also developed an interesting solid-phase parallel synthesis of substituted benzimidazoles and benzoxazoles under focused microwave irradiation. The key step involved the amidation of 4-hydroxy-3-nitrobenzoic acid with polymer immobilized *o*-phenylenediamine (Scheme 41).⁷⁸ Application of mild acidic conditions promoted the ring closure to afford benzimidazole system. After catalytic hydrogenation of nitro group, the resulted conjugated polymer underwent efficient ring closure with various alkyl, aryl and heteroaryl isothiocyanates to generate the polymer-bound benzimidazolyl-benzoxazole derivatives. The compounds were finally cleaved from the support using 1% KCN to give biaryl benzimidazolyl-benzoxazole

derivatives in good yields. These compounds were then evaluated for their activity against vascular endothelial growth factor receptor (VEGFR-3) and showed moderate activity. This methodology was also applied by the same authors for the synthesis of other fused heterocycles including trisubstituted imidazo[1,2- α]benzimidazoles (Scheme 41).⁷⁹

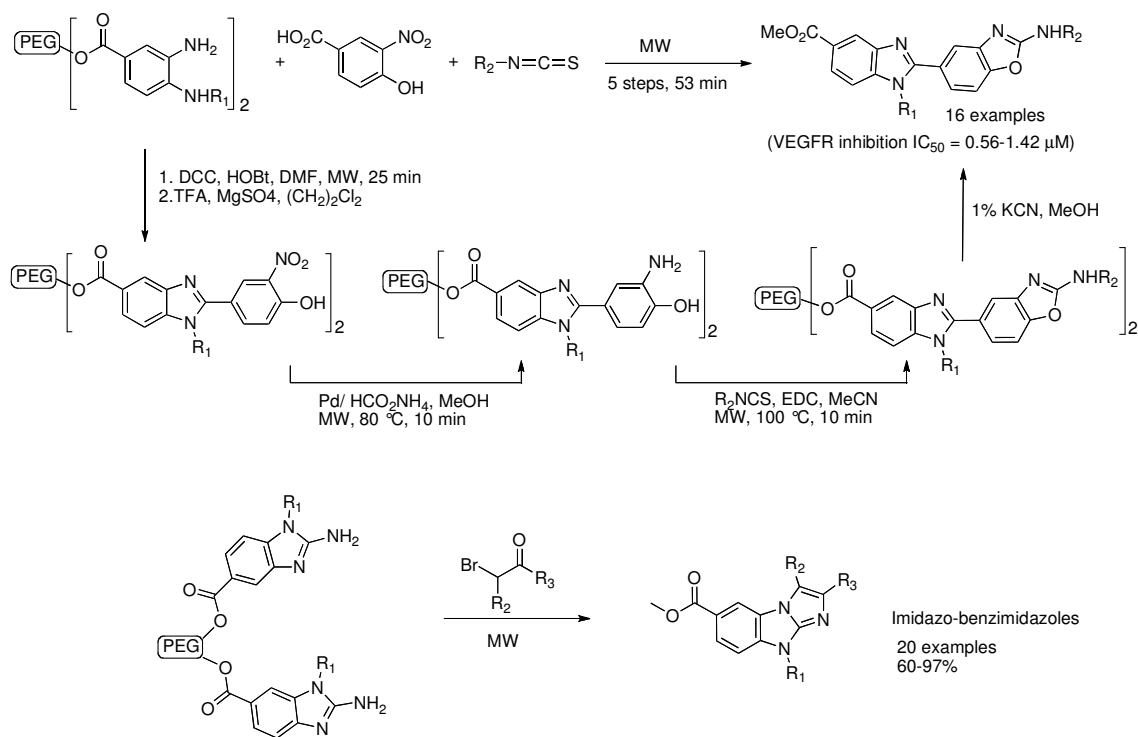

Scheme 41

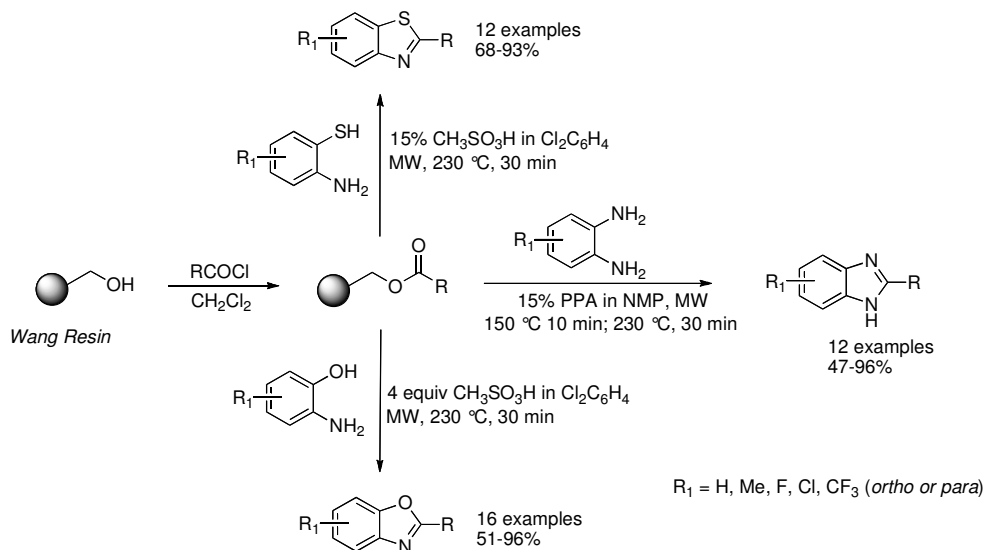

Scheme 42

Lim *et al.* described the solid-phase synthesis of benzimidazoles, benzoxazoles and benzothiazoles on resin-bound esters using microwave activation (Scheme 42).⁸⁰ Benzothiazoles and benzoxazoles were synthesized in good yields by condensation of mercapto- or hydroxy-anilines with on resin-bound esters in the presence of methanesulfonic acid under microwave irradiation. *ortho*-Substituted anilines also reacted

efficiently in NMP and gave, after microwave heating (150 °C), the corresponding benzimidazoles in 47–96% yields. This approach is highly attractive and could be applied for the construction of diversely functionalized compound libraries.

Polyfluorinated benzothiazoles can also be prepared from haloanilines under microwave irradiation (Scheme 43).⁸¹ Indeed, 2-haloanilines reacted with 2.2 equiv. of potassium *O*-ethyl dithiocarbonate at 120 °C for 8–15 min. The resulting mixture was then treated with various fluorinated benzyl bromides at 90 °C under microwave irradiation to give the corresponding 2-substituted benzylthio-benzothiazoles. The reaction time has been brought down from hours to minutes with improved yields as compared to conventional heating. Furthermore, Bioassay indicated that most of the compounds showed significant fungicidal activity against *Rhizoctonia solani*, *Botrytis cinereapers* and *Dothiorella gregaria* at 50 µg/mL.

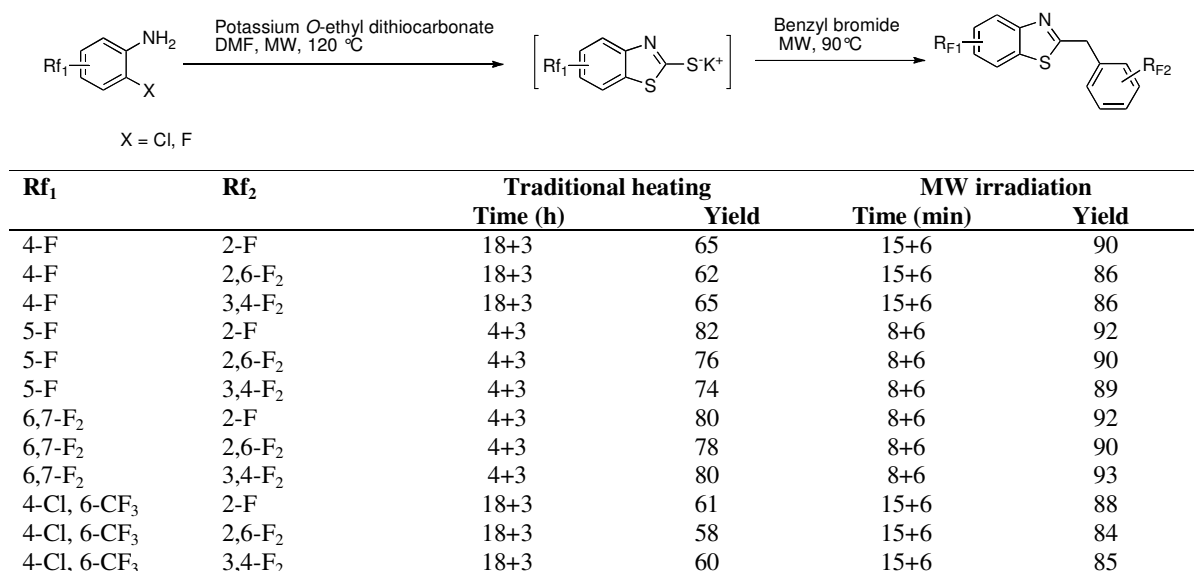

Scheme 43

Radi *et al.* reported a one-pot, two-step synthesis of functionalized benzoxazoles and benzothiazoles using solid-phase protocol and microwave irradiation (open vessel).⁸² Benzothiazoles were obtained by on-resin cyclodehydration of 2-aminothiophenols (Scheme 44).

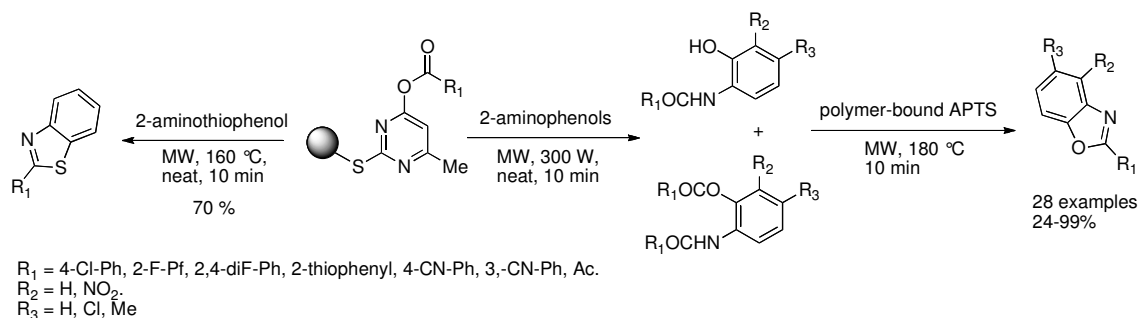

Scheme 44

This one-pot two-step methodology was also applied for the synthesis of functionalized benzoxazoles. In the first step, the supported reagents were submitted to an excess of substituted aminophenols (2 equiv.) to shift the equilibrium toward the formation of the uncyclized intermediates. The PTSA-polymer-bound was

then added in the second step and allowed to scavenge the unreacted basic species and to catalyze the cyclodehydration reaction. The removal of the combined solid supports by filtration allowed access to the benzoxazole series. The authors also described the parallel version of this methodology by using automated Buchi Syncore parallel synthesizer and CEM microwave reactor, which allowed the speed up of benzoxazoles synthesis. Products were obtained in good yields under microwave irradiation and after a short reaction time (MW, 300 W, 180 °C, 10 minutes).

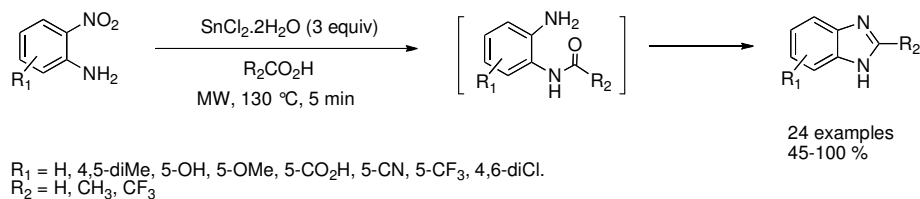

Scheme 45

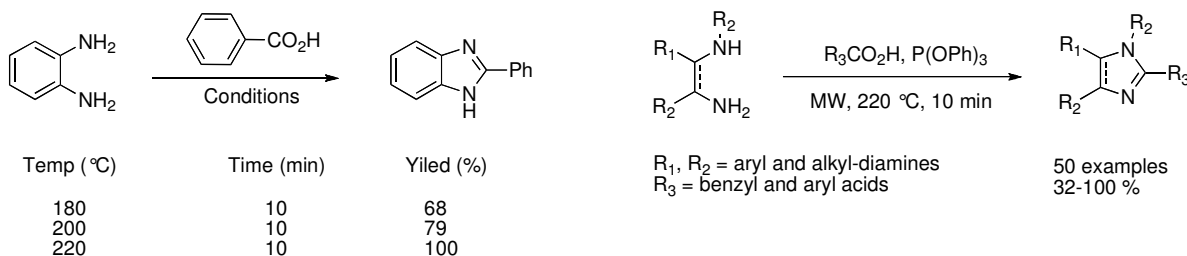

Scheme 46

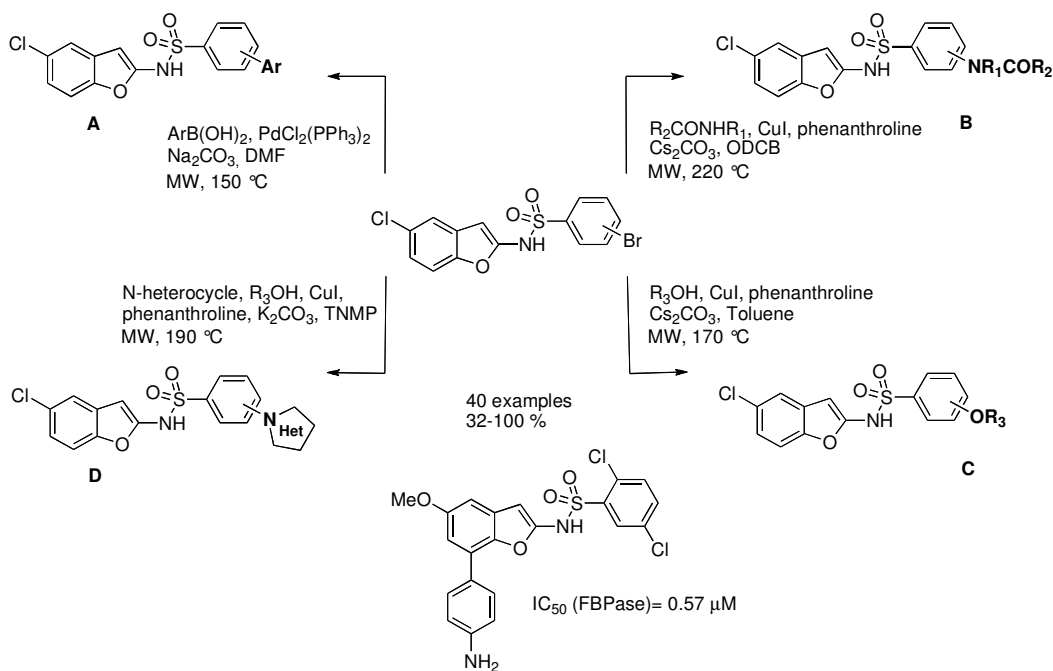

Scheme 47

For the preparation of 2-substituted benzimidazoles, *o*-nitroanilines can be condensed with acids, reduced with $\text{SnCl}_2 \cdot 2\text{H}_2\text{O}$ and then cyclized *in situ* under microwave irradiation (Scheme 45).⁸³ High yields were obtained after a short reaction time except in the case where trifluoroacetic acid was used ($R_2 = \text{CF}_3$) in

the condensation reaction with 4-carboxy-2-nitroaniline (45%). In some cases, the *N*-acylphenylenediamine intermediate was observed as the side product where complete conversion was not achieved. Benzimidazoles can also be obtained in similar way using P(OPh)₃ as additive (Scheme 46). The condensation was first surveyed with *o*-phenylenediamine and benzoic acid to give 2-phenylbenzimidazole with a complete conversion under microwave irradiation. This process tolerated various substitutions on diamines and acid partners giving good to excellent yields of functionalized benzimidazoles.⁸⁴

Modular functionalization of benzoxazole benzensulfonamides under microwave irradiation was reported by Lai *et al.* as allosteric inhibitors of fructose-1,6-biphosphatase (FBPase-1).⁸⁵ A modular variation of different groups on the phenyl ring was accomplished in a parallel synthesis fashion through the common *bromo*-intermediate (Scheme 47). The first **A** series was prepared by Suzuki coupling reaction. The synthesis of the other **B**, **C** and **D** series was achieved *via* the copper-assisted nucleophilic substitution reactions (Scheme 47). Biological evaluation of these compounds on FBPase-1 enzyme led to potent bioactive molecules with sub-micromolar activity (IC₅₀ ≤ 0.57 μM).

2.5. Five-membered heterocycles with three heteroatoms

2.5.1. Triazoles

Triazoles are important target molecules in organic synthesis due to their widespread use and importance as interesting pharmacophores in drug discovery. Two regioisomers of triazole are known, namely 1,2,3- and 1,2,4-triazoles. 1,2,4-Triazoles represent a class of heterocyclic compounds of significant importance in agriculture and medicine.⁸⁶ They were used in a wide variety of applications, most notably in organometallic chemistry and as bioactive molecules.⁸⁷

1,2,3-Triazole moiety does not occur in nature. This explains the fact that no 1,2,3-triazolyl compounds have been isolated from natural source. Synthetic molecules containing 1,2,3-triazole ring were reported to have diverse biological activities including antibacterial, herbicidal, fungicidal, antiallergic and anti-HIV.⁸⁸ Furthermore, 1,2,3-triazoles have found extensive industrial use as corrosion inhibitors, dyes, photostabilizers, photographic materials and agrochemicals.

Numerous synthetic approaches to this class of compounds have been developed. Among them, the azide-alkyne Huisgen cycloaddition is the well-known method. In this approach, organic azides and acetylenic compounds undergo a 1,3-dipolar cycloaddition to give 1,2,3-triazoles. Generally, the classical Huisgen-type cycloaddition required elevated temperatures and long reaction times and usually afford a mixture of 1,4- and 1,5-regioisomers (Scheme 48).⁸⁹

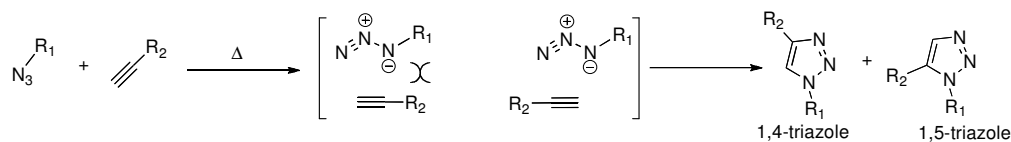

Scheme 48

Recently, the groups of Sharpless⁹⁰ and Meldal⁹¹ have reported independently that this reaction can be efficiently catalyzed with copper (I) salts (Cu^I) to give exclusively the 1,4-substituted regioisomer with an increased reaction rate up to 10⁷ times, eliminating therefore the need for elevated temperatures. This discovery has become one of the highly efficient ways for the preparation of triazoles, known as “click chemistry” reaction. The accepted mechanism of the Cu^I catalyzed azide-alkyne cycloaddition reaction

(CuAAC) is shown in Scheme 49. It involves the initial formation of a π complex by the coordination between a terminal alkyne and Cu^{I} leading to the formation of the active copper acetylide species. The latter evolves to a copper acetylide-azide complex upon attack of the organic azide and then undergoes an intramolecular cyclization to give a six-membered copper metallacycle. Sequential ring contraction and proteolysis lead to the desired 1,4-disubstituted 1,2,3-triazoles with the regeneration of the catalyst.

Due to this powerful click reaction and to the interesting properties of triazoles in the context of biological and pharmacological applications, an enormous development in click chemistry has been achieved in the last few years for the preparation of triazoles containing peptides, oligosaccharides, natural product analogues and others molecules, especially under microwave irradiation. Some important examples are given in this section for the synthesis of triazoles using a cooperative effect of microwave irradiation and Cu-catalysis.

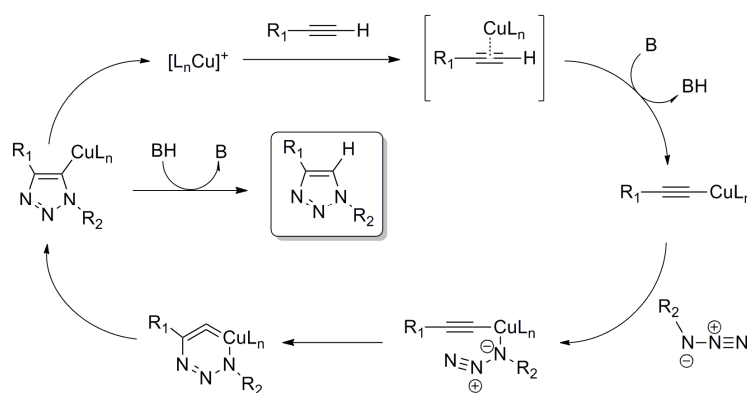

Scheme 49

2.5.1.1. Synthesis of 1,2,3-triazoles

2.5.1.1.1. Synthesis using Cu^{II} salts

The addition of a Cu^{II} source with a reducing agent is one of the preferred methods. In the last few years, many authors have used this method to maintain the Cu^{I} catalyst at a high level during the click reaction. Usually, copper sulphate and sodium ascorbate are used successively as Cu^{II} source, which is reduced *in situ* to generate Cu^{I} in organic solvent-water media (*t*-BuOH/ H_2O).

For example, Castagnolo *et al.*⁹² have applied this condition, under microwave irradiation, to the synthesis of a small library of enantiomerically pure α -[4-(1-substituted)-1,2,3-triazol-4-yl]benzylacetamides starting from the racemic arylpropargylamines. Products were obtained, after few minutes, in good yields and high enantiomeric excess (Scheme 50).

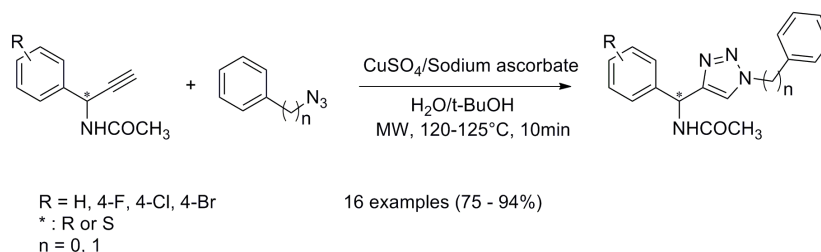

Scheme 50

In order to study the microwave effect, Ritter developed the synthesis of polymerizable cyclo-dextrin monomethacrylate under the same conditions and at a fixed temperature in both cases (microwave irradiation and conventional heating).⁹³ They found that, under conventional heating and Cu^{I} catalysis, the reaction afforded a mixture of 1,4- and 1,5-disubstituted regioisomers while under microwave irradiation, the reaction led exclusively to the 1,4-disubstituted triazoles with an important decrease of the reaction time (Scheme 51).

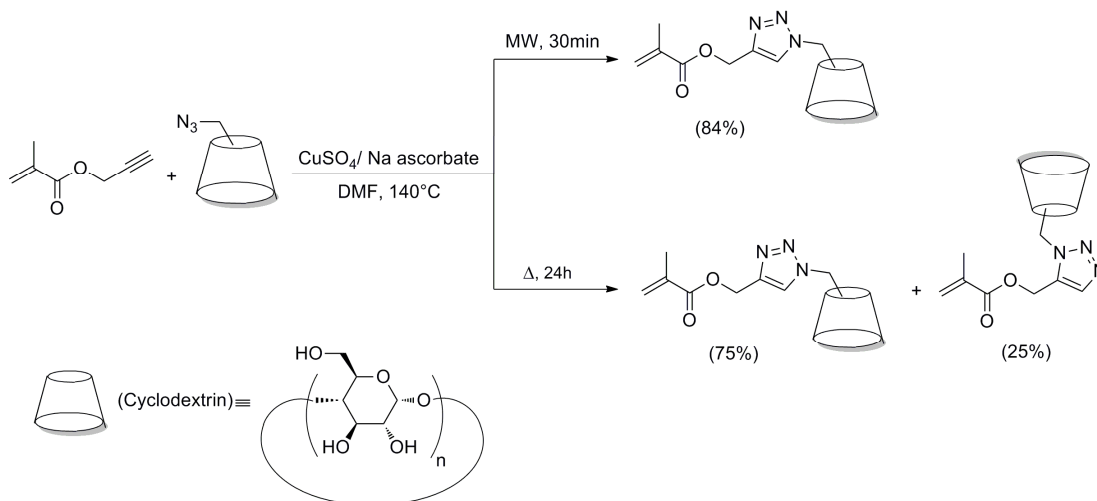

Scheme 51

Pore *et al.*⁹⁴ also reported another example of Cu^{I} -catalyzed alkyne-azide cycloaddition reaction and confirmed the advantage of microwave irradiation over conventional heating. The authors described the synthesis of novel fluconazole-bile conjugated acids, obtained in excellent yield (90–95%) under microwave heating and within a short reaction time (5 minutes). Reactions were carried out using catalytic amount of copper sulphate (5 mol%) and 40% molar of sodium ascorbate (Scheme 52). In contrast to microwave activation, the same reaction, when realized under classical condition at 50–60 °C, only afforded 10% yield of triazole products, after a long reaction time (3 days).

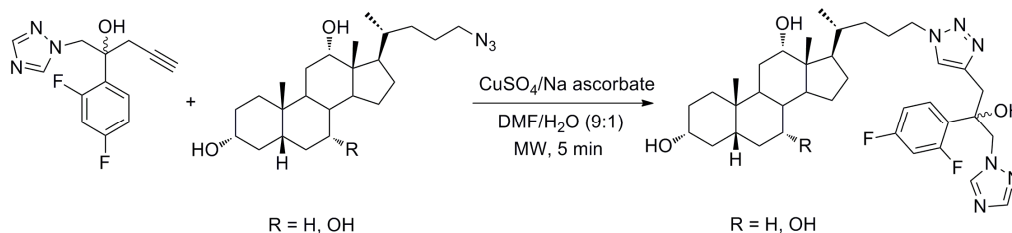

Scheme 52

Similar conditions were also applied in other reported works for the synthesis of important target molecules containing the triazole ring such as calixarenes,⁹⁵ multivalent dendrimeric peptides,⁹⁶ glyco-dendrimers,⁹⁷ nucleosides,⁹⁸ oligonucleotides,⁹⁹ cyclodextrins¹⁰⁰ and pseudorotaxane blocks.¹⁰¹

In the context of seeking other reducing agents, Lipshutz and co-workers¹⁰² showed that the click reaction could be heterogeneously catalyzed by Cu^{II} -nanoparticles. Reactions were cleanly achieved in few minutes under microwave irradiation (150 °C) using dioxane and without base catalysis. The Cu^{I} active species was probably generated from *in situ* reduction of Cu^{II} (Scheme 53).

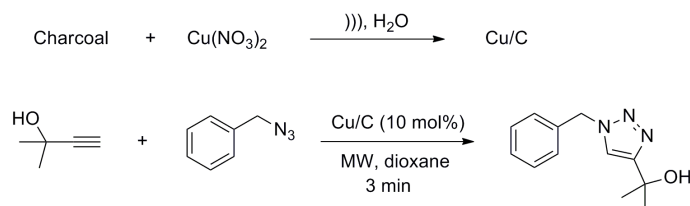

Scheme 53

2.5.1.1.2. Synthesis using Cu^I salts

In this case, the Cu^I was directly used as a catalyst, in the presence of ligand in order to stabilize the air-sensitive Cu^I form and to accelerate the cycloaddition reaction. Generally, copper iodide and *di*-isopropylethylamine (DIPEA) are used as the Cu^I source and ligand, respectively.

Guezguez *et al.*¹⁰³ have reported the first example of Cu^I-promoted regioselective synthesis of functionalized α - or β -1,2,3-triazolyl nucleosides through a 1,3-dipolar cycloaddition between α - or β -azido-2-deoxyribose and a range of functionalized terminal alkynes, under microwave activation and solvent-free conditions. The reaction was performed in the presence of DIPEA and Cu^I adsorbed on silica gel solid support. The cycloaddition proceeded cleanly under microwave irradiation since triazolyl-nucleosides were obtained in near quantitative yields and within a short reaction time (1.5–3 minutes, Scheme 54). In contrast to MW activation, slow reaction rates were noticed under classical heating and a long reaction time was required to achieve moderate yields (24 hours at 110 °C).

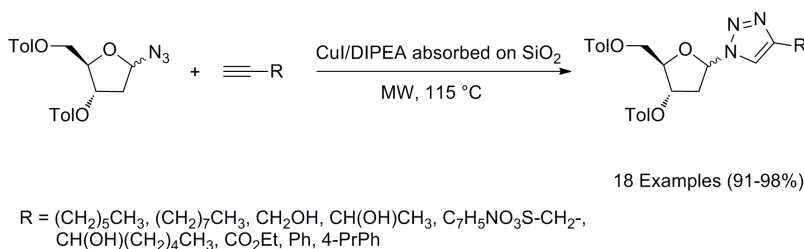

Scheme 54

The same authors also applied this methodology in ribose series for the synthesis of bioactive modified nucleosides as anticancer drugs.¹⁰⁴

Furthermore, ionic liquids are considered as green solvents and as good absorbers of microwave energy and appeared to be ideal medium for performing reactions under microwave irradiation. Recently, the group of Dondoni¹⁰⁵ has used ionic liquids (IL) and microwave irradiation for the synthesis of glycoside clusters. The cycloaddition reaction was performed using sugar alkynes and *tetra*-azido calix[4]arene in the presence of CuI and DIPEA. The best results were obtained when *N*-octyl dabco-cation based dicyanamide ([C₈dabco][N(CN)₂] was used as ionic liquid (Scheme 55). These examples clearly showed that microwave activation not only reduced the reaction time significantly but also increased the efficiency of the multiple click reactions in one step. Other organic solvents can also be employed in this reaction⁹⁸ and triethylamine can be used instead of DIPEA for the synthesis of 1,2,3-triazoles under microwave irradiation.¹⁰⁶ By applying similar conditions in organic solvents, other works have been reported using different Cu^I sources for the synthesis of bioactive molecules featuring a functionalized 1,2,3-triazolyl ring. Some important examples are summarized in the Table 1.

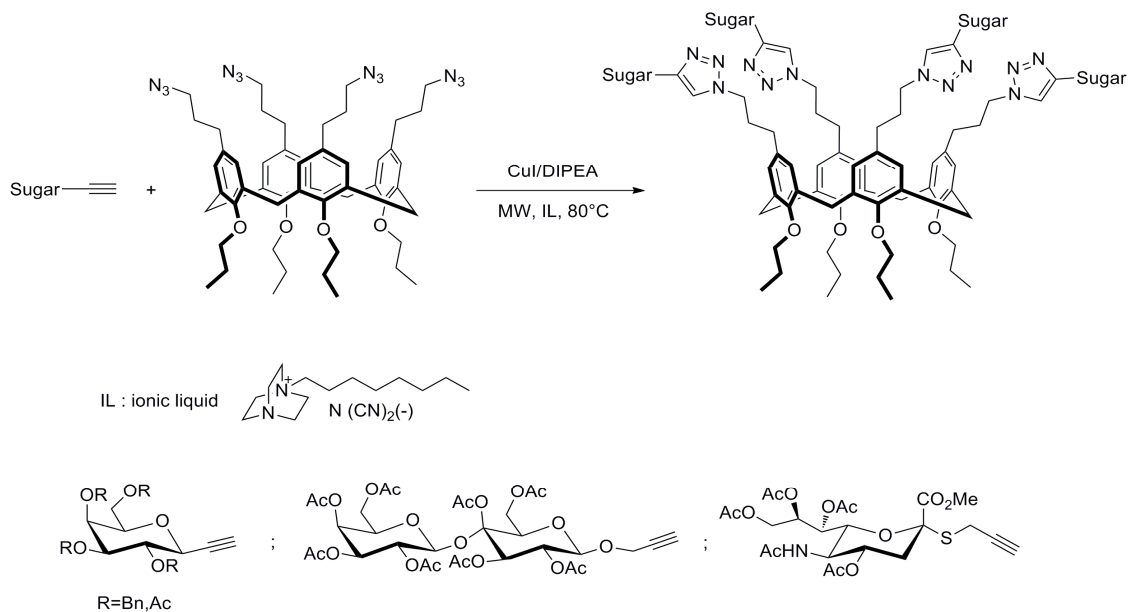

Method	Time (h)	Yield (%)
MW, IL, 80 °C	2	32, 72-90
Thermal heating, Toluene, 80 °C	16	58-84

Scheme 55

Table 1

Cu ^I source	Base	Solvent	Temp (°C)	Time (min)	Yield (%)	Synthesized Molecules	Ref
CuCl	-	toluene/H ₂ O	80 to 140	20 to 40	51-91	glycoporphyrins	107
Cu(PPh ₃) ₃ Br	DIPEA	THF	140	20	92-95	dendrimers	108
CuBr·SMe ₂	-	THF	50	60	84	oligonucleotides	109
CuI·Et ₃ P	DIPEA	toluene	90	20	88	glyco-silicas	110
Cu(MeCN) ₄ ·PF ₆	-	DMSO	-	1	61-91	deoxystreptamine analogues	111

2.5.1.1.3. Synthesis using Cu⁰ and Cu^{II}

It is known that copper wire and CuSO₄ underwent transformation to form the active Cu^I catalyst, which can be used in the Huisgen cycloaddition. This approach is particularly attractive since copper metal and copper sulphate are inexpensive.

In view of generating biologically and pharmacologically interesting target molecules, Kaval *et al.*¹¹² investigated the application of the Cu metal/CuSO₄ mixture for the decoration of the 2-(1*H*)-pyrazinone scaffold. The reaction was carried out with microwave irradiation in *t*-BuOH/H₂O mixture (Scheme 56).

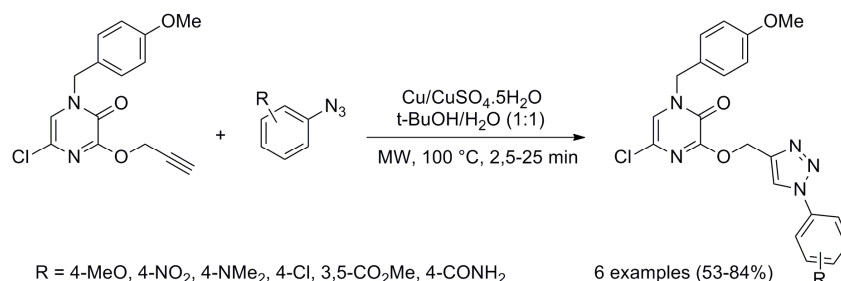

Scheme 56

Moreover, this group showed that, when Cu^I-complexing ligands were added to the solution, the reaction times were dramatically reduced.

In similar way, Agrofoglio group used the couple of Cu⁰/Cu^{II} in the synthesis of 1,2,3-triazolo-carbanucleosides from protected¹¹³ or unprotected¹¹⁴ cyclopentane azide derivatives. Pisaneschi *et al.*¹¹⁵ have also reported similar methodology for the synthesis of α -proline substituted with different triazoles ring.

1,2,3-Triazoles can also be prepared directly from amines or organic halides in one-pot reaction without isolation of the organic azide intermediates. Several procedures have been recently reported to generate, in one-pot and under microwave irradiation, the desired 1,2,3-triazoles starting from amines^{116,117} or from organic halides.^{92a,118,119}

In 2008, Moses and Moorhouse¹¹⁶ have efficiently accomplished the synthesis of aromatic azides from the corresponding aryl-amines with *tert*-butyl nitrile and azidotrimethylsilane. Various 1,4-triazoles were prepared using CuSO₄/sodium ascorbate and microwave activation (Scheme 57). The procedure is particularly amenable to electron-deficient anilines and worked well with a wide variety of alkynes including aromatic, conjugated, aliphatic, electron-rich and electron-deficient.

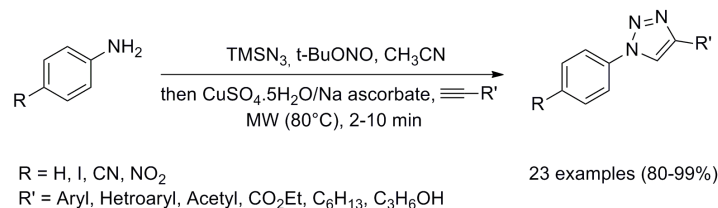

Scheme 57

Similarly, Wittmann and Beckmann¹¹⁷ have developed a one-pot reaction based on Cu^{II}-catalyzed diazo transfer with trifluoromethanesulfonyl azide to generate *in situ* the organic azide, which were then coupled with alkynes to give functionalized triazoles. In another approach, starting from organic halides, Biehl and co-workers¹¹⁸ reported a convenient multi-component one-pot procedure for the preparation of 1-substituted benzotriazoles. The synthesis involved a clean and efficient microwave-assisted 1,3-dipolar cycloaddition reaction of azides and arynes, generated by the reaction of *o*-trimethylsilylaryl triflates with KF/18-Crown-6 in acetonitrile. The benzotriazoles were obtained in good to excellent yields after 20 minutes under microwave irradiation (Scheme 58).

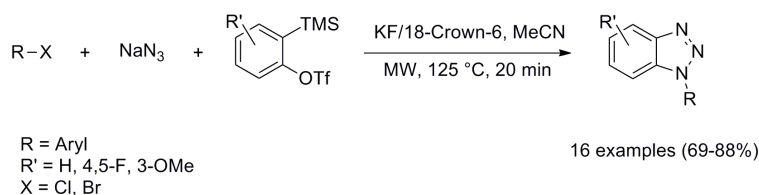

Scheme 58

The intramolecular version of the Huisgen cycloaddition is a potentially useful reaction for the stereocontrolled preparation of 1,5-disubstituted and 1,4,5-trisubstituted triazoles.

In this context, Balducci *et al.*¹²⁰ have observed that α -azido propargylamides undergo intramolecular Huisgen cycloaddition in MeCN/H₂O under microwave dielectric heating to give 1,2,3-triazolo-pyrazinones in good yields (Scheme 59).

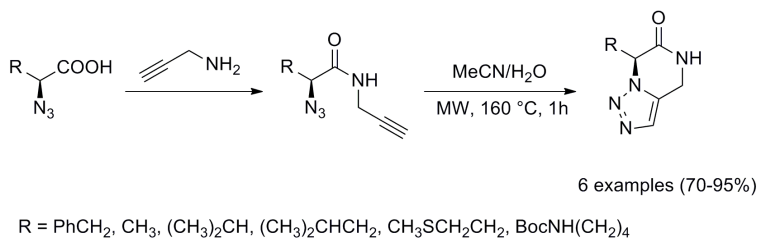

Scheme 59

The click chemistry was also applied for the modification of artificial nucleic acids RNA and DNA. Recently, Morvan and co-workers described the synthesis of cyclic, branched, and bicyclic triazolo-oligonucleotides using a cooperative effect of copper catalysis and microwave activation.¹²¹

2.5.1.1.4. Other methods for the synthesis of 1,2,3-triazoles

Other methods were reported in literature for the synthesis of 1,2,3-triazoles using other catalysts.^{122–125} For example, the group of Fokin¹²² has developed in 2007 a regioselective synthesis of 1,5-disubstituted 1,2,3-triazoles from various aryl azides and alkynes *via* Ruthenium-catalyzed 1,3-dipolar cycloaddition. Reactions were carried out under microwave activation to produce regioselectively the 1,5-regioisomers of 1,2,3-triazoles in high yields and within a short reaction time (Scheme 60).

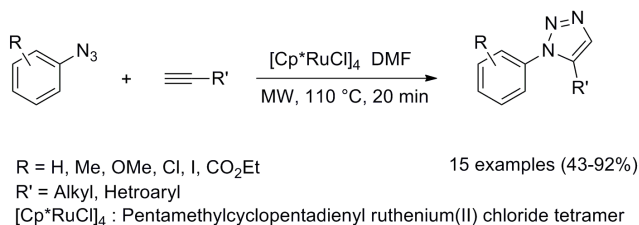

Scheme 60

This methodology was also applied by Agrofoglio *et al.*¹²³ for the synthesis of 1,5-disubstituted 1,2,3-triazolo-nucleosides using the commercially available [Cp*RuCl(PPh₃)₂] catalyst.

Furthermore, it is known that reaction of internal alkynes with unsubstituted azides required a long reaction time. To circumvent this drawback, Tsai *et al.*¹²⁴ have developed a straightforward strategy for the selective synthesis of 4,5-disubstituted-2*H*-1,2,3-triazoles. These derivatives were obtained in good to excellent yields by reaction of internal 2-alkyne derived from benzonitriles with sodium azide under microwave irradiation (Scheme 61). Interestingly, in this work, complete conversions were achieved in few minutes under microwave irradiation while more than 6 days are required under conventional heating.

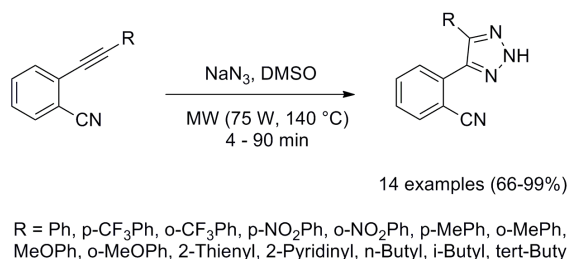

Scheme 61

2.5.1.2. Synthesis of 1,2,4-triazoles

In the last years, a number of works were reported for the synthesis of 1,2,4-triazoles under microwave irradiation using as starting substrates hydrazines^{126,127} or hydrazides.^{128–130} For example, Wang *et al.*¹²⁶ have developed a one step reaction protocol for the synthesis of triazolopyridines starting from carboxylic acids and 2-hydrazinopyridines using solid-phase supported reagents on PS-PPh₃ resin and CCl₃CN, in combination with microwave heating. This methodology allowed access to functionalized triazolopyridines in good yields (Scheme 62). The PS-PPh₃/CCl₃CN combination appeared to play a dual role in the acylation and dehydration steps.

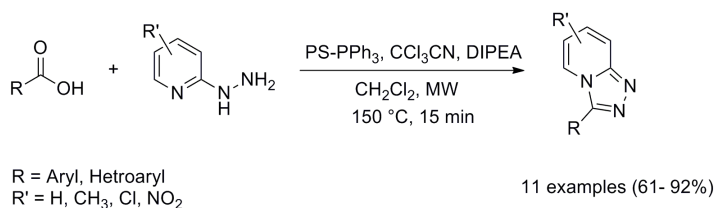

Scheme 62

The group of Yeung¹²⁸ has developed an efficient one step synthesis of 3,5-disubstituted 1,2,4-triazoles. The process was based on base-catalyzed condensation of nitriles and hydrazides in BuOH and in the presence of catalytic amount of K₂CO₃, which produced the substituted triazoles in 34–84% yields (Scheme 63).

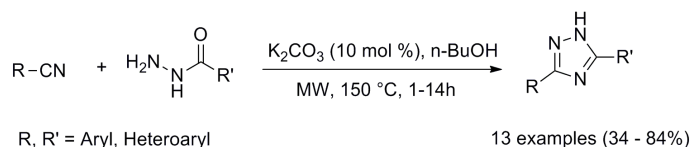

Scheme 63

Following a similar mechanistic pathway, Lindsley's group described, in a recent publication, a high-yielding protocol for the synthesis of triazolo-pyridazines by the condensation of hydrazides with 3,6-dichloropyridazines under microwave irradiation.¹²⁹

2.5.2. Oxadiazoles and thiadiazoles

Oxadiazoles and oxathiazoles are well-known as bioactive molecules (agonists, antagonists, enzymes inhibitors, etc) and as amide bioisosters mainly used in the development of peptidomimetic drugs (Scheme 64).¹³¹

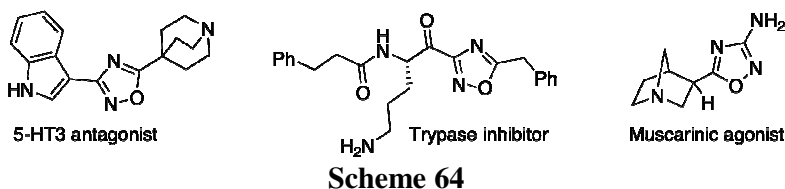

Scheme 64

Oxadiazoles are classically synthesized by reactions of amidoximes with carboxylic acids or by 1,3-dipolar cycloadditions of nitrile oxides with nitriles.¹³² Several procedures were described for the synthesis of oxadiazoles and thiadiazoles under microwave activation. For example, Adib *et al.* reported a

one-pot, three-component synthesis of 3,5-disubstituted 1,2,4-oxadiazoles under solvent-free conditions.¹³³ The reaction involved the condensation between nitriles, hydroxylamines and aldehydes (Scheme 65). The aryl nitriles and hydroxylamine were first converted to amidoximes in the presence of catalytic amounts of AcOH under microwave irradiation. The latter were then condensed with aldehydes to produce 1,2,4-oxadiazoles. This procedure is highly efficient since only 4 minutes were required to achieve complete conversion and excellent yields of 1,2,4-oxadiazoles.

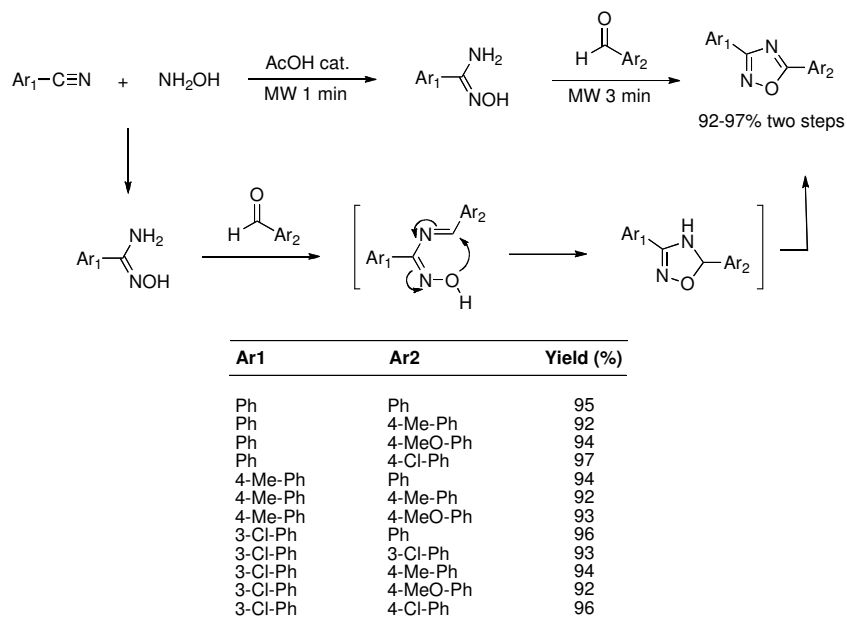

Scheme 65

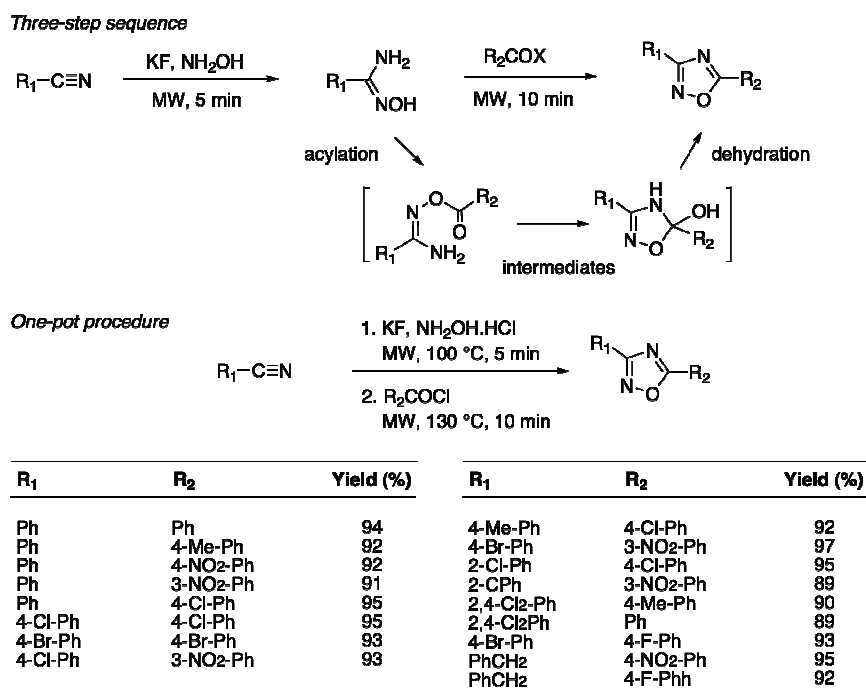

Scheme 66

More recently, Rostamizadeh *et al.* described similar approach on solid support using potassium fluoride (KF) as catalyst.¹³⁴ 3,5-Disubstituted-1,2,4-oxadiazoles were first prepared in three steps by reaction

of nitriles with hydroxylamine hydrochloride and acyl chlorides in the presence of supported KF (Scheme 66). The authors also reported a one-pot version of this procedure using solvent-free conditions and microwave irradiation, which produced high yields (89–97 %) of the corresponding substituted oxadiazoles (Scheme 66).

Antifungal 1,3,4-oxadiazoles were recently prepared, using both microwave and conventional heating, by condensation of heterocyclic hydrazides and aldehydes (Scheme 67).¹³⁵ Reactions were carried out in ethanol-water mixture (1/2) at 100 °C in the presence of sodium bisulfite (NaHSO₃, 20% molar). Under conventional heating, this transformation required 9–10 hours while under microwave activation complete conversions were achieved after only 10–15 minutes. The authors also reported the antifungal activity of this series of compounds against various strains such as *Candida albicans*, *Fusarium oxysporum*, *Aspergillus flavus*, *Aspergillus niger* and *Cryptococcus neoformans*. Some of these compounds were found to be active with an MIC (Minimum inhibitory concentration)=15–30 μM, particularly for R₁=SO₂Me and R₂=Cl or OH (Scheme 67).

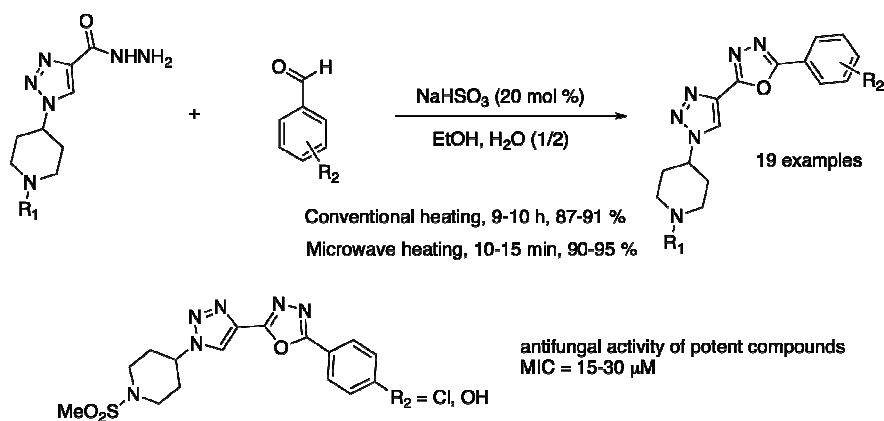

Scheme 67

An elegant approach was reported by Ley for the synthesis of a library of 5-substituted-2-amino-1,3,4-oxadiazoles and their thiadiazole analogues using polymer-supported reagents and microwave activation (Scheme 68).¹³⁶ The process involved a one-pot synthesis of 2-aminosulfonate derivatives through a three-components coupling of acylhydrazines, isocyanates and sulfonylchlorides promoted by a polymer-supported phosphazine base. In the first route (A), the authors reported polymer-supported DCC (PS-DCC) for the synthesis of 2-amino-1,3,4-oxadiazoles. Using DMF as solvent and microwave activation, a series of compounds was obtained in good yields after 1 hour at 140 °C. In the second route, other substituted 2-amino-1,3,4-oxadiazoles were prepared in 58–83 % yields using PS-triphenylphosphine and carbon tetrabromide. The authors also described the effect of base-supported polymer in the outcome of the cyclodehydration reaction with sulfonylchlorides. For example, high selectivity was observed with PS-DMAP, which led exclusively to compound **A** whereas the use of PS-BEMP afforded only compound **B**. This interesting methodology was also applied for the synthesis of 1,3,4-oxathiazoles using the cyclodehydration of thiourea as a key step.

Thiadiazoles can also be prepared from tetrazoles under microwave irradiation. Indeed, 5-substituted tetrazoles reacted with phenyl isothiocyanate to produce 2-substituted-5-phenylamino-thiadiazoles (Scheme

69).¹³⁷ The authors observed that the microwave irradiation strongly affects the reaction in comparison with conventional heating. For example, the reaction of 5-(pyridin-2-yl)-1*H*-tetrazole and phenyl isothiocyanate did not work under conventional heating (170 °C, 2 hours) while the same reaction when conducted under microwave irradiation and at the same temperature afforded the corresponding thiadiazoles in 50% yield.

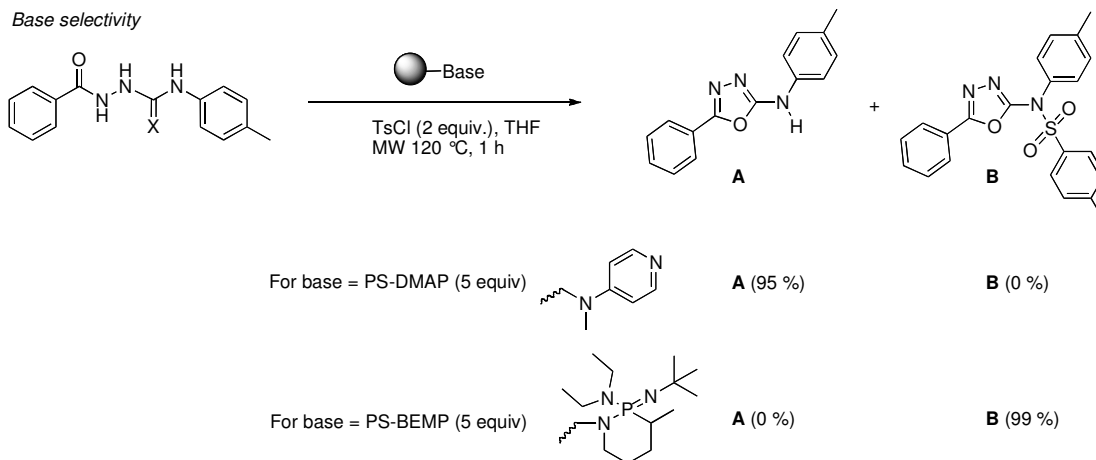
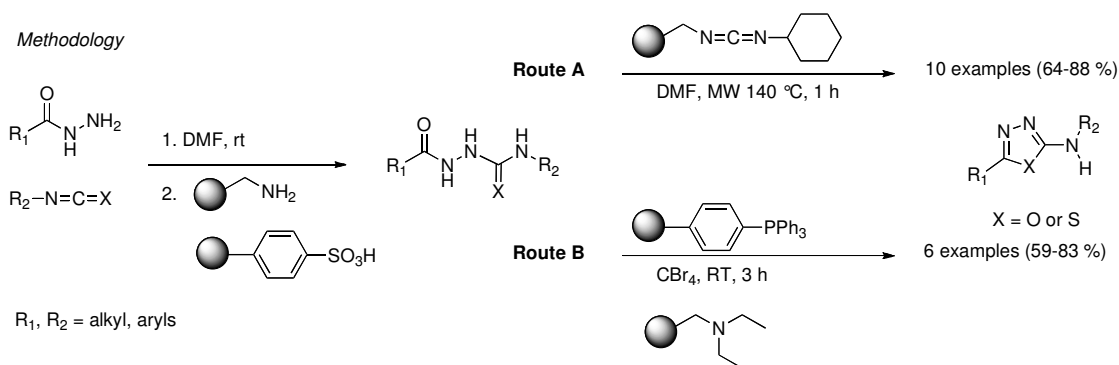

Synthesis of thiadiazoles

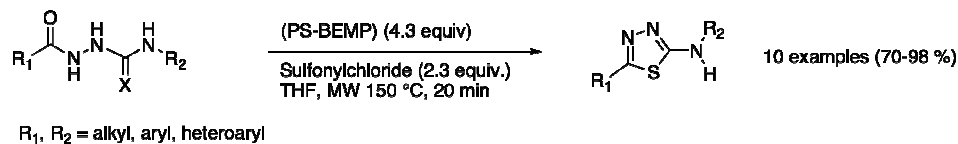

Scheme 68

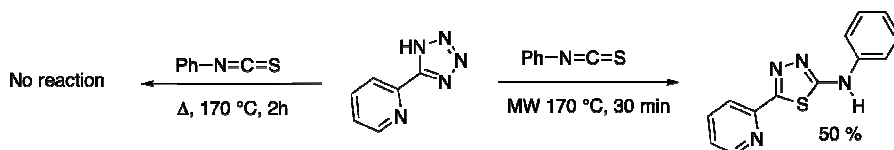
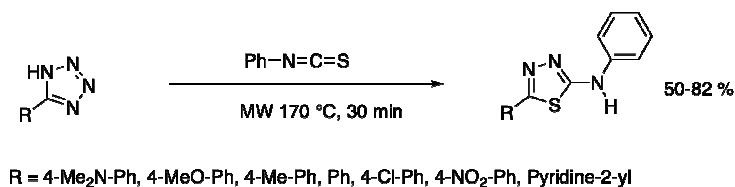

Scheme 69

2.6. Five-membered ring with four heteroatoms

2.6.1. Tetrazoles

Tetrazoles are important heterocyclic compounds in organic and medicinal chemistry. They are known as acid bioisosters and were commonly used to increase the target affinity, specificity and pharmacokinetic properties.¹³⁸ The first synthesis of a tetrazole system was reported by Baladin in 1885.¹³⁹ Furthermore, tetrazole derivatives are mostly prepared by nitrile-azide 1,3-dipolar cycloaddition.¹⁴⁰ Disubstituted tetrazoles can also be obtained from amides, thioamides and oximes.¹⁴¹

Recently, various methodologies were reported for the synthesis and functionalization of tetrazoles under microwave activation. For example, Lukyanov *et al.* reported a microwave-assisted synthesis and transformation of aryl- and heteroaryl-tetrazoles (Scheme 70).¹⁴²

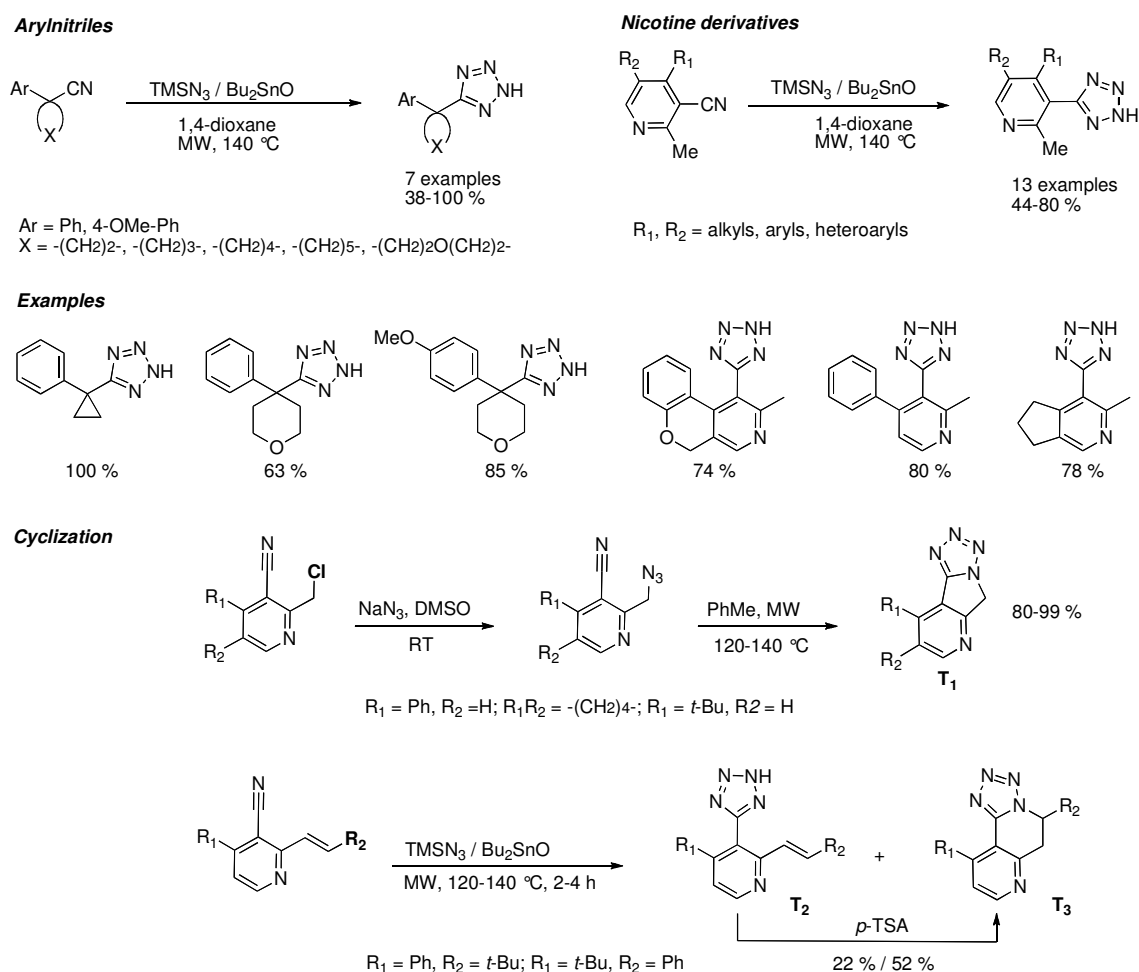

Scheme 70

The optimal conditions were first determined in the aryl series using 1,3-dipolar cycloaddition between aryl-nitriles and trimethylsilylazide (TMSN₃) in dioxane and in the presence of Bu₂SnO. The reaction rate and yields were found to be highly depending on the ratio of reactants, with the optimal molar ratio being: nitrile/Bu₂SnO/TMSN₃=1/0.3/4. They also observed that the yields of tetrazole products also decreased gradually with the growth of the carbocycle size, with the best yield obtained in the case of cyclopropane (100%). The yield can also be increased by a prolongation of microwave irradiation as well as by increasing Bu₂SnO ratio. This procedure was then applied to nicotinonitrile series leading to various substituted

3-(5-tetrazolyl)pyridines in 44–80% yields. The authors also observed that, when nicotinonitrile featuring a reactive CH₂-Cl group in α -position was used in the cycloaddition with NaN₃, the reaction led to the tricyclic product **T**₁. In similar way, nicotinonitrile with a vinyl group in α -position afforded, under microwave irradiation, the tetrazole products **T**₂ and **T**₃ in 22% and 52%, respectively. **T**₂ can be converted to **T**₃ using *p*-toluenesulfonic acid.

Different from the previous case where a tin oxide was used to promote the dipolar cycloaddition, Shie *et al.* reported the cycloaddition of nitriles catalyzed by ZnBr₂.¹⁴³ The functionalized nitriles were obtained *in situ* from aldehydes (I₂, NH_{3(aq)}) and were reacted with NaN₃/ZnBr₂ under microwave irradiation at 80 °C for 10 minutes to furnish the corresponding 5-aryl-1,2,3,4-tetrazoles in 70–83% yields (Scheme 71). The authors also reported that the condensation of nitriles with dicyanamide using a focused microwave reactor (80–100 W) led to the [2+3] cycloadducts, 2,6-diamino-1,3,5-triazines in 69–83% yields. This procedure is interesting since it allowed a direct conversion of alcohols and aldehydes to tetrazoles and triazines.

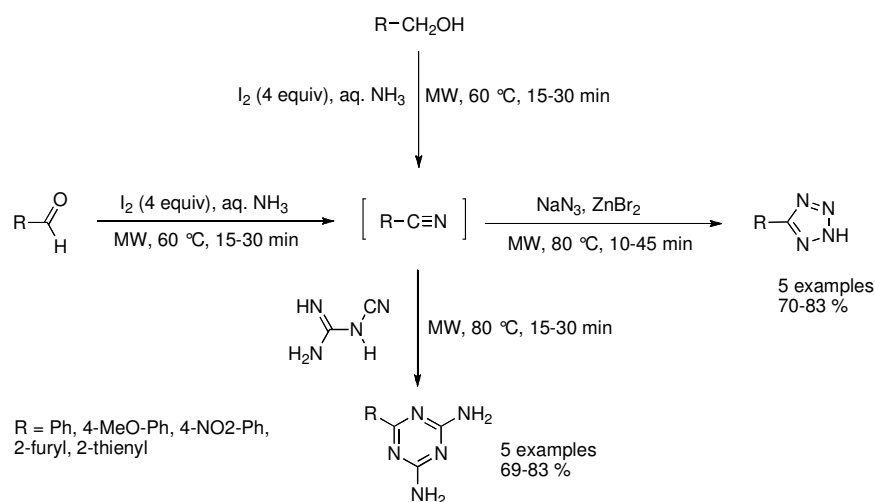

Scheme 71

The Ugi four-component reaction was also reported for the synthesis of tetrazoles. Nayak and Barta described the preparation of isonitriles from the Baylis-Hillman adducts of acrylates and their utilization in the synthesis of tetrazolo-fused diazepinones *via* post-Ugi cyclization (Scheme 72).¹⁴⁴

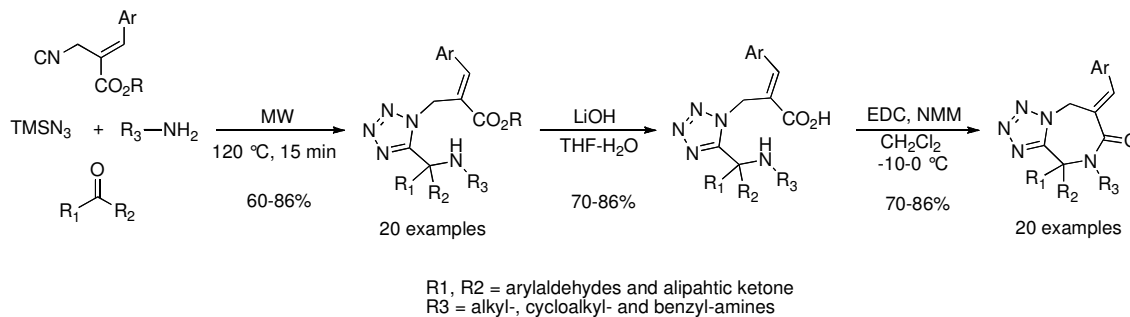

Scheme 72

The first key step involved four-component condensation and was conducted under microwave heating to produce highly substituted 1,5-tetrazoles in 60–86% yields. These tetrazoles were then transformed in two steps to their corresponding tetrazolo-fused diazepinones in good yields.

Schmidt *et al.* described microwave-assisted synthesis of aryl-tetrazoles using [2+3] cycloaddition of nitriles and azides in ionic liquids derived from alkyl-imidazoles (Scheme 73).¹⁴⁵ In this work, the temperature was first optimized to achieve complete conversion. The authors observed that electron-deficient substrates reacted efficiently at 70 °C whereas the less electron deficient reagents, such as pyrazine-2-carbonitrile, required higher temperatures (130 °C) and extended reaction time. In similar way, electron-rich substrates such as 4-methoxy-benzonitrile and biphenyl-nitriles required prolonged reaction times and higher temperatures (140–170 °C) that induced concomitant product degradation. Interestingly, the optimized conditions were found to be those carried out under microwave heating using NaN₃, AcOH and ionic liquids as shown in Scheme 73. The reaction times were dramatically shortened using microwave heating at 200 W, thus avoiding the product decomposition.

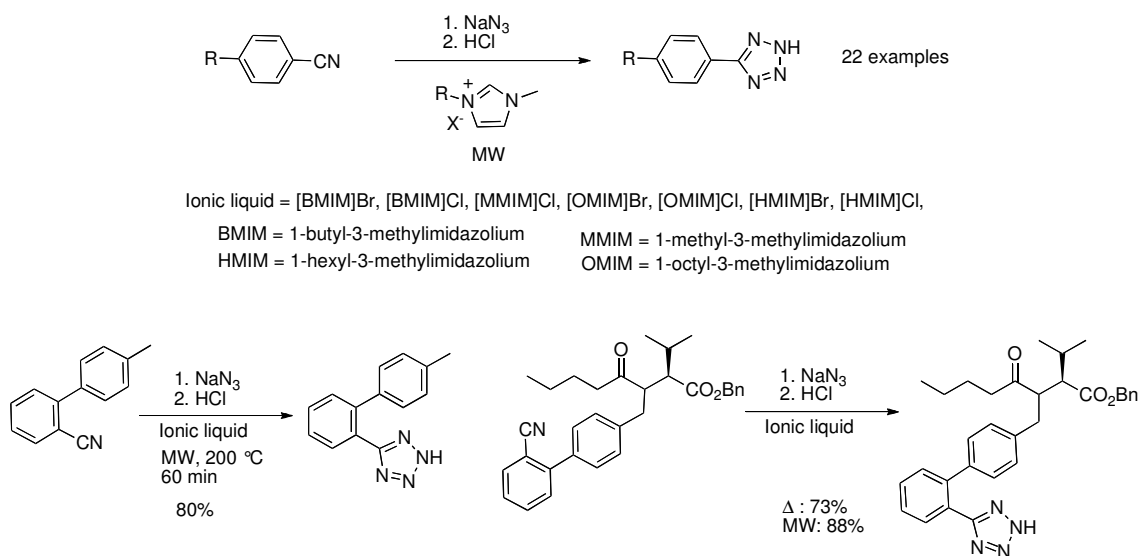

Scheme 73

Various post-transformations of tetrazoles were also reported using microwave-assisted reactions. For example, the *N*-arylation of tetrazoles was reported by Efimova *et al.* using nucleophilic aromatic substitution reaction (S_NAr) of *p*-fluoro-nitrobenzene in the presence of NaOH in DMSO to give a mixture of regioisomers (Scheme 74).¹⁴⁶ Indeed, the arylation of 5-methyl, 5-benzyl, and 5-chlorobenzyl-tetrazoles afforded mixtures of 1- and 2-aryl-5-alkyltetrazole isomers with N₁/N₂ ratio varying from 1/2 to 2/3. In these cases, the microwave heating was found to increase the arylation yields but did not affect the N₁ vs N₂ regioselectivity. In similar way, *N*-glycosylation of bromo- or triflate-sugars was reported by Couri *et al.* for the synthesis of nucleoside analogues. Reactions were carried out by mixing 2,3,4,6-*tetra-O*-acetyl- α -D-glucopyranosyl bromide or 2,3,6-*tri-O*-benzyl-4-*O*-triflyl- α -D-glucopyranose, K₂CO₃ and tetrazole in acetone.¹⁴⁷ In contrast to conventional heating, the isolated yields were increased and the reaction time was shortened under microwave conditions, giving a mixture of N₁- and N₂-glycosylated products. The site of glycosylation was classically attested by ¹H, ¹³C and HMBC NMR data of the isolated regioisomers. In the case of the tetrazole where R₁=SH, R₂=Ph, the glycosylation reaction occurred at the *S*-site leading to the *S*-glycosylated products.

Substituted-tetrazoles can also be prepared from halogenated tetrazoles *via* Pd-catalyzed Suzuki-Miyaura cross-coupling.¹⁴⁸ 5-Chloro-1-phenyltetrazole was reacted with various boronic acids in the

presence of catalytic amounts of Pd source. Different conditions were surveyed for this transformation including the nature of ligand, source of Pd and the solvent. The best conditions were those employing Pd(OAc)₂ (5% molar), RuPhos (2-dicyclohexylphosphino-2',6'-diisopropoxybiphenyl, 10% molar) in butanol/H₂O (3/1) with the use of K₃PO₄ as base. Under these conditions and in combination with microwave activation, the coupling products were generally obtained in moderate to good yields (Scheme 75).

A. S_NAr Arylation

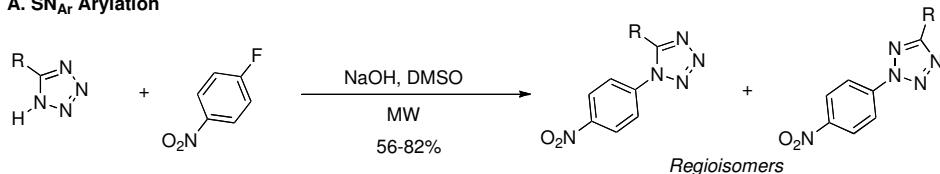

R = Me, PhCH₂, 4-Cl-PhCH₂, 4-MeO-Ph, 4-Me-Ph, 4-Cl-Ph

B. N-glycosylation

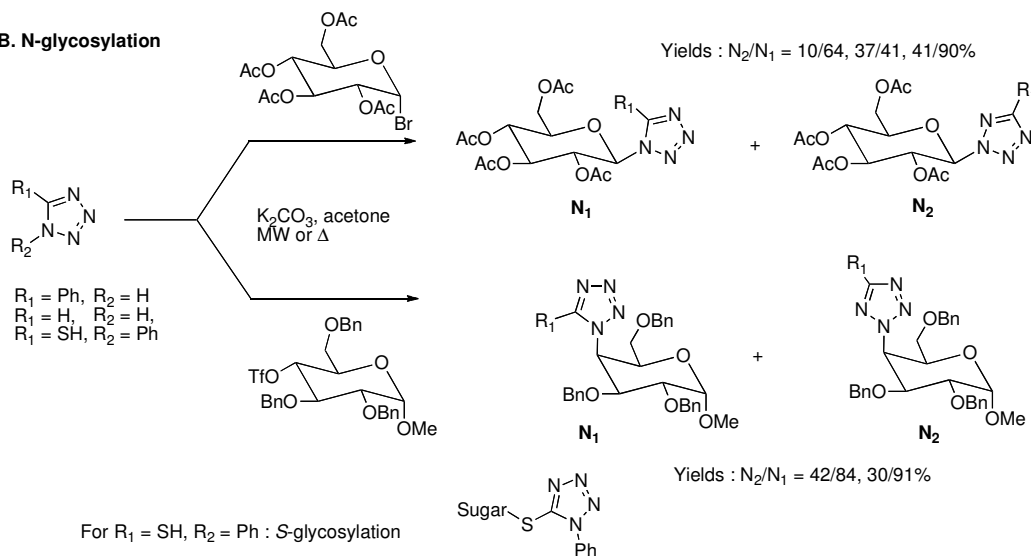

Scheme 74

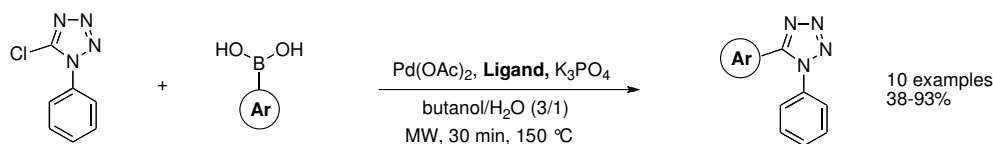

Ar = substituted benzene, 2-thienyl, 2-furyl, 4-(1-methyl)pyrazolyl

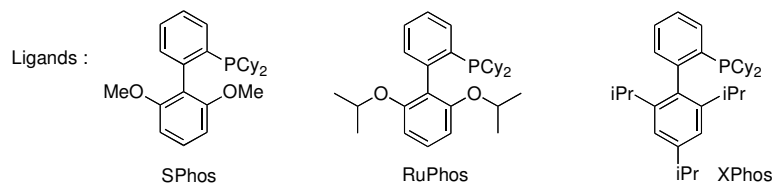

Scheme 75

3. Conclusion

The examples described in this chapter illustrate that microwave-assisted synthesis can allow easy and rapid access to various heterocyclic systems, in particular three-, four- and five-membered rings including nitrogen-, oxygen- and sulfur-containing molecules that may have interesting pharmaceutical potential.

This chapter is not intended to be exhaustive in its content, but rather to emphasize significant examples where microwave irradiation has been either synthetically facilitating or has afforded a solution advantage over classical thermal methods. The description of the combination of heterocyclic chemistry and microwave irradiation has also shown that performing microwave-assisted reactions should be considered with particular attention. A few of these considerations can be applied generally for conducting microwave-assisted reactions and include the following: (a) the ratio between the quantity of catalyst or the starting material and the support or the solvent is very important; (b) for solid starting materials, the use of solid supports can offer operational, economical and environmental benefits over conventional methods. Other aspects can comprise unanswered questions relating to the existence of “intrinsic microwave effects” and the scalability and the overall energy efficiency of this technique. This technology is still under-used and has the potential to have a large impact on the fields of organic and medicinal chemistry and drug development.

Acknowledgments

This book-chapter is based on Driowya's PhD research work (University of Nice Sophia Antipolis, France and University Med V-Agdal of Rabat, Morocco). UNS, CNRS, CNRST (RS/2011/01), Egide (PAI HC MA/09/217, 20538WC), le Conseil Régional PACA (France), MAE (Euro-mediterranean ARCUS-CERES project) and OribasePharma (Montpellier, France) are gratefully acknowledged for financial support. The authors also thank Egide and AUF for Eiffel and AUF Grants to MD.

References

- (a) Stuerger, D. *Microwave-Material Interactions and Dielectric Properties, Key Ingredients for Mastery of Chemical Microwave Processes* In *Microwaves in Organic Synthesis, 2nd Ed.*; Loupy, A., Ed.; Wiley-VCH: Weinheim, 2006; pp. 1–61. (b) Michael, D.; Mingos, P. *Theoretical Aspects of Microwave Dielectric Heating* In Tierney, J. P. *Microwave Assisted Organic Synthesis*; Tierney, J. P.; Lidström, P., Eds.; Blackwell: Oxford, 2005; pp. 1–22. (c) Stuerger, D.; Delmotte, M. *Wave-Material Interactions, Microwave Technology and Equipment* In *Microwaves in Organic Synthesis*; Loupy, A., Ed.; Wiley-VCH: Weinheim, 2002; pp. 1–33. (d) Gabriel, C.; Gabriel, S.; Grant, E. H.; Halstead, B. S.; Mingos, D. M. P. *Chem. Soc. Rev.* **1998**, *27*, 213–224. (e) Mingos, D. M. P.; Baghurst, D. R. *Chem. Soc. Rev.* **1991**, *20*, 1–47.
- (a) Perreux, L.; Loupy, A. *Nonthermal Effects of Microwaves in Organic Synthesis* In *Microwaves in Organic Synthesis, 2nd Ed.*; Loupy, A., Ed.; Wiley-VCH: Weinheim, 2006; pp. 134–218. (b) Herrero, M. A.; Kremsner, J. M.; Kappe, C. O. *J. Org. Chem.* **2008**, *73*, 36–47.
- (a) Gedye, R.; Smith, F.; Westaway, K.; Ali, H.; Baldisera, L.; Laberge, L.; Rousell, J. *Tetrahedron Lett.* **1986**, *27*, 1279–1283. (b) Gedye, R.; Smith, F.; Westaway, K. *Can. J. Chem.* **1988**, *66*, 17–28. (c) Giguere, R. J.; Bray, T. L.; Duncan, S. M.; Majetich, G. *Tetrahedron Lett.* **1986**, *27*, 4945–4948.
- (a) *Microwaves in Organic Synthesis 2nd Ed.*; Wiley-VCH: Weinheim, 2006. (b) Bougrin, K.; Loupy, A.; Soufiaoui, M. *J. Photochem Photobiol C* **2005**, *6*, 139–167. (c) *Microwave Assisted Organic Synthesis*; Lidstrom, P.; Tierney, J. P., Eds.; Blackwell Publishing: Oxford, 2005. (d) *Microwave Methods in Organic Synthesis*; Larhed, M.; Olofsson, K., Eds.; Springer: Berlin, 2006. (e) *Microwave-Assisted Synthesis of Heterocycles*; Van der Eycken, E.; Kappe, C. O., Eds.; Springer: Berlin, 2006. (f) Chemat, F.; Lucchesi, M. E. *Microwave-Assisted Extraction of Essential Oils*. In *Microwaves in Organic Synthesis 2nd Ed.*; Loupy, A., Ed.; Wiley-VCH: Weinheim, 2006. (g) Vazquez, E.; Prato, M. *ACS Nano* **2009**, *3*, 3819–3824. (h) Economopoulos, S. P.; Rotas, G.; Miyata, Y.; Shinohara, H.; Tagmatarchis, N. *ACS Nano* **2010**, *4*, 7499–7507. (i) Kharissova, O. V.; Kharisov, B. I.; Ruiz Valdes, J. J. *Ind. Eng. Chem. Res.* **2010**, *4*, 1457–1466. (j) Lehmann, H.; LaVecchia, L. *Org. Process Res. Dev.* **2010**, *14*, 650–656.

5. (a) Liu, J. F. *Curr. Org. Synth.* **2007**, *4*, 223–237. (b) Du, W.; Kulkarni, S. S.; Gervay-Hague *J. Chem. Commun.* **2007**, 2336–2338. (c) Chen, S.; Huang, H.; Liu, X.; Shen, J.; Jiang, H.; Liu, H. *J. Comb. Chem.* **2008**, *10*, 358–360.
6. (a) Martins, M. A. P.; Frizzo, C. P.; Moreira, D. N.; Zanatta, N.; Bonacorso, H. G. *Chem. Rev.* **2008**, *108*, 2015–2050. (b) Dallinger, D.; Kappe, C. O. *Chem. Rev.* **2007**, *107*, 2563–2591. (c) Bougrin, K.; Bashiardes, G.; Soufiaoui, M. *Microwaves in Cycloaddition In Microwaves in Organic Synthesis 2nd Ed.*; Loupy A., Ed.; Wiley-VCH: Weinheim, 2006; pp. 524–573. (d) Polshettiwar, V.; Varma, R. *Acc. Chem. Res.* **2008**, *41*, 629–639. (e) Caddick, S.; Fitzmaurice, R. *Tetrahedron* **2009**, *65*, 3325–3355. (f) Kappe, C. O.; Van der Eycken, E. *Chem. Soc. Rev.* **2010**, *39*, 1280–1290. (g) Appukkuttan, P.; Mehta, V. P.; Van der Eycken, E. *Chem. Soc. Rev.* **2010**, *39*, 1467–1477.
7. Ishikura, M.; Hasunuma, M.; Yamada, K.; Yanada, R. *Heterocycles* **2006**, *68*, 2253–2257.
8. Wu, R.; Lu, X.; Zhang, Y.; Zhang, J.; Xiong, W.; Zhu, S. *Tetrahedron* **2008**, *64*, 10694–10698.
9. Leinonen, H.; Rintala, J.; Siitonen, A.; Lajunen, M.; Pettersson, M. *Carbon* **2010**, *48*, 2425–2434.
10. Liu, Y.; Che, C-M. *Chem. Eur. J.* **2010**, *16*, 10494–10501.
11. Gayon, E.; Debleds, O.; Nicouleau, M.; Lamaty, F.; Van Der Lee, A.; Vrancken, E.; Compagne, J-M. *J. Org. Chem.* **2010**, *75*, 6050–6053.
12. Caddick, S.; Fitzmaurice, R. *Tetrahedron* **2009**, *65*, 3325–3355.
13. Berardi, S.; Bonchio, M.; Carraro, M.; Conte, V.; Sartorel, A.; Scorrano, G. *J. Org. Chem.* **2007**, *72*, 8954–8957.
14. *Thiiranes and Thiirenes In Comprehensive Heterocyclic Chemistry*; Ditter, D. C.; Katritzky, A. R.; Rees, C. W., Eds.; Pergamon: Elmsford, NY, 1984; Vol. 7, pp. 132–182.
15. Zeynizadeha, B.; Yeghaneha, S. *Phosphorus Sulfur Silicon Relat. Elem.* **2009**, *184*, 362–368.
16. Von Nussbaum, F.; Brands, M.; Hinzen, B.; Weigand, S.; Häbich, D. *Angew. Chem. Int. Ed.* **2006**, *45*, 5072–5129.
17. Hugonnet, J.-E.; Tremblay, L. W.; Boshoff, H. I.; Barry, C. E., 3rd.; Blanchard, J. S. *Science* **2009**, *323*, 1215–1218.
18. For a review, see: Xing, B.; Rao, J.; Liu, R. *Mini-Rev. Med. Chem.* **2008**, *8*, 455–471.
19. Dandia, A.; Singh, R.; Khaturia, S. *J. Fluorine Chem.* **2007**, *128*, 524–529.
20. Jiao, L.; Liang, Y.; Xu, J. *J. Am. Chem. Soc.* **2006**, *128*, 6060–6069.
21. Minetto, G.; Raveglia, L. F.; Taddei, M. *Org. Lett.* **2004**, *6*, 389–392.
22. Ngwerume, S.; Camp, J. E. *J. Org. Chem.* **2010**, *75*, 6271–6274.
23. Bremner, W. S.; Organ, M. G. *J. Comb. Chem.* **2007**, *9*, 14–16.
24. Treu, M.; Karner, T.; Kousek, R.; Berger, R.; Mayer, M.; McConnell, D. B.; Stadler, A. *J. Comb. Chem.* **2008**, *10*, 863–868.
25. (a) Fischer, E.; Jourdan, F. *Chem. Ber.* **1883**, *16*, 2241–2245. (b) Fischer, E.; Hess, O. *Chem. Ber.* **1884**, *17*, 559–568.
26. Pchalek, K.; Jones, A. W.; Wekking, M. M. T.; Black, D. S. C. *Tetrahedron* **2005**, *61*, 77–82.
27. Wagaw, S.; Yang, B. H.; Buchwald, S. L. *J. Am. Chem. Soc.* **1999**, *121*, 10251–10263.
28. For the reviews, see: (a) Zeni, G.; Larock, R. C. *Chem. Rev.* **2004**, *104*, 2285–2309. (b) Cacchi, S.; Fabrizi, G. *Chem. Rev.* **2005**, *105*, 2873–2920. (c) Zeni, G.; Larock, R. C. *Chem. Rev.* **2006**, *106*, 4644–4680. (d) Luo, P.; Tang, R.-Y.; Zhong, P.; Li, J.-H. *Chin. J. Org. Chem.* **2009**, *29*, 1924–1937.
29. (a) Patil, S. A.; Patil, R.; Miller, D. D. *Curr. Med. Chem.* **2011**, *18*, 615–637. (b) Sridharan, V.; Perumal, S.; Avendano, C.; Menendez, J. C. *Synlett* **2006**, 91–95.
30. Lehmann, F.; Holm, M.; Laufer, S. *Tetrahedron Lett.* **2009**, *50*, 1708–1709.
31. Kranjc, K.; Kocevar, M. *Tetrahedron* **2008**, *64*, 45–52.
32. Kraus, G. A.; Guo, H. *Org. Lett.* **2008**, *10*, 3061–3063.
33. Lipinska, T. M.; Czarnocki, S. *J. Org. Lett.* **2006**, *8*, 367–370.
34. Karthikeyan, S. V.; Perumal, S.; Shetty, K. A.; Yogeewari, P.; Sriram, D. *Bioorg. Med. Chem. Lett.* **2009**, *19*, 3006–3009.
35. Chen, Y.; Markina, N. A.; Larock, R. C. *Tetrahedron* **2009**, *65*, 8908–8915.
36. Carpita, A.; Ribecai, A. *Tetrahedron Lett.* **2009**, *50*, 6877–6881.

37. Petronijevic, F.; Timmons, C.; Cuzzupe, A.; Wipf, P. *Chem. Commun.* **2009**, 104–106.
38. DiMauro, E. F.; Vitullo, J. R. *J. Org. Chem.* **2006**, *71*, 3959–3962.
39. Jacubert, M.; Provot, O.; Peyrat, J-F.; Hamze, A.; Brion, J-D.; Alami, M. *Tetrahedron* **2010**, *66*, 3775–3787.
40. Drew, B. G.; Kingwell, B. A. *Expert Opin Pharmacother.* **2008**, *9*, 2137–2144.
41. Van Den Neste, E.; Van den Berghe, G.; Bontemps, F. *Expert Opin. Investig. Drugs* **2010**, *19*, 571–578.
42. Forte, B.; Malgesini, B.; Piutti, C.; Quartieri, F.; Scolaro, A.; Papeo, G. *Mar. Drugs* **2009**, *7*, 705–753.
43. Pereira, C. P.; De Oliveira, P. R.; Furquim, K. C.; Bechara, G. H.; Camargo-Mathias, M. I. *Exp. Parasitol.* **2011**, *127*, 481–489.
44. Grossmann, K.; Ehrhardt, T. *Pest. Management Sci.* **2007**, *63*, 429–439.
45. De Clercq, E. *Med. Res. Rev.* **2009**, *29*, 611–645.
46. Sparks, R. B.; Combs, A. P. *Org. Lett.* **2004**, *6*, 273–2475.
47. Wolkenberg, S. E.; Wisnoski, D. D.; Leister, W. H.; Wang, Y.; Zhao, Z.; Lindsley, C. W. *Org. Lett.* **2004**, *6*, 1453–1456.
48. (a) Ermolat'ev, D. S.; Babaev, E. V.; Van der Eycken, E. V. *Org. Lett.* **2006**, *8*, 5781–5784. (b) Ermolat'ev, D. S.; Alifavov, V. L.; Rybakov, V. B.; Babaev, E. V.; Van der Eycken, E. V. *Synthesis* **2008**, *13*, 2083–2088.
49. Persson, T.; Nielsen, J. *Org. Lett.* **2006**, *8*, 3219–3222.
50. Deshmukh, M. B.; Jagtap, S. S.; Desmukh, S. A. *J. Indian Chem. Soc.* **2006**, *83*, 1055–1057.
51. Chebanov, V. A.; Saraev, V. E.; Desenko, S. M.; Chernenko, V. N.; Shishkina, S. V.; Shishkin, O. V.; Kobzar, K. M.; Kappe, C. O. *Org. Lett.* **2007**, *9*, 1691–1694.
52. Lee, J. C.; Seo, J. W.; Back, J. W. *Synth. Commun.* **2007**, *37*, 2159–2162.
53. (a) *Oxazoles: Synthesis, Reactions and Spectroscopy, Part B*; Palmer, D. C., Ed.; John Wiley: Hoboken, NJ, 2004. (b) Yeh, V. S. C. *Tetrahedron* **2004**, *60*, 11995–12042. (c) Kean, W. F. *Curr. Med. Res. Opin.* **2004**, *20*, 1275–1277.
54. Nolt, M. B.; Smiley, M. A.; Varga, S. L.; McClain, R. T.; Wolkenberg, S. E.; Lindsley, C. W. *Tetrahedron* **2006**, *62*, 4698–4704.
55. Mabrou, M.; Bougrin, K.; Benhida, R.; Soufiaoui, M. *Tetrahedron Lett.* **2007**, *48*, 443–447.
56. Castellano, S.; Tamborini, L.; Viviano, M.; Pinto, A.; Sbardella, G.; Conti, P. *J. Org. Chem.* **2010**, *75*, 7439–7442.
57. Di Credico, B.; Reginato, G.; Gonsalvi, L.; Peruzzini, M.; Rossin, A. *Tetrahedron* **2011**, *67*, 267–274.
58. Khan, A.; Alam, M.; Mushfiq, M. *Chinese Chem. Lett.* **2008**, *19*, 1027–1030.
59. Castagnolo, D.; Pagano, M.; Bernardini, M.; Botta, M. *Synlett* **2009**, 2093–2096.
60. Kazmaier, U.; Ackermann, S. *Org. Biomol. Chem.* **2005**, *3*, 3184–3187.
61. (a) Sondhi, S. M.; Singh, N.; Kumar, A.; Lozach, O.; Meijer, L. *Bioorg. Med. Chem.* **2006**, *14*, 3758–3765. (b) Vinsova, J.; Cermakova, K.; Tomeckova, A.; Ceckova, M.; Jampilek, J.; Cermak, P.; Kunes, J.; Dolezal, M.; Staud, F. *Bioorg. Med. Chem.* **2006**, *14*, 5850–5865.
62. Pytela, O.; Klimesova, V. *Chem. Pharm. Bull.* **2011**, *59*, 79–184.
63. Belmar, J.; Para, M.; Zuniga, C.; Perez, C.; Munoz, C. *Liq. Cryst.* **1999**, *26*, 389–396.
64. Edwards, P. D.; Meyer, E. F.; Vijayalakshmi, J.; Tuthill, P. A.; Andisik, D. A.; Gomes, B.; Strimpler, A. *J. Am. Chem. Soc.* **1992**, *114*, 1854–1863.
65. Rodembusch, F. S.; Buckup, T.; Segala, M.; Tavares, L.; Correia, R. R. B.; Stefani, V. *Chem. Phys.* **2004**, *305*, 115–121.
66. Gong, J. R.; Wan, L.-J.; Lei, S.-B.; Bai, C.-L.; Zhang, X.-H.; Lee, S.-T. *J. Phys. Chem. B* **2005**, *109*, 1675–1682.
67. (a) Reddy, B. S. P.; Sondhi, S. M.; Lown, J. W. *Pharmacol. Ther.* **1999**, *84*, 1–111. (b) Neidle, S. *Nat. Prod. Rep.* **2001**, *18*, 291–309.
68. Emmitte, K. A.; Adjebang, G. M.; Andrews, C. W.; Alberti, J. G.; Bambal, R.; Chamberlain, S. D.; Davis-Ward, R. G.; Dickson, H. D.; Hassler, D. F.; Hornberger, K. R.; Jackson, J. R.; Kuntz, K. W.; Lansing, T. J.; Mook, R. A.; Nailor, K. E.; Pobanz, M. A.; Smith, S. C.; Sung, C. M.; Cheung, M.

- Bioorg. Med. Chem. Lett.* **2009**, *19*, 1694–1697.
69. Sun, Q.; Wu, R.; Cai, S.; Lin, Y.; Sellers, L.; Sakamoto, K.; He, B.; Peterson, B. R. *J. Med. Chem.* **2011**, *54*, 1126–1139.
 70. Hohmann, C.; Schneider, K.; Bruntner, C.; Irran, E.; Nicholson, G.; Bull, A. T.; Jones, A. L.; Brown, R.; Stach, J. E.; Goodfellow, M.; Beil, W.; Krämer, M.; Imhoff, J. F.; Süßmuth, R.; Fiedler, H-P. *J. Antibiot.* **2009**, 1–6.
 71. Daboit, T. C.; Stopiglia, C. D. O.; Carissimi, M.; Corbellini, V. A.; Stefani, V.; Scroferneker, M. L. *Mycoses* **2009**, *52*, 507–510.
 72. Harmata, M.; Hong, X. *Org. Lett.* **2005**, *7*, 3581–3583.
 73. Ovenden, S. P. B.; Nielson, J. L.; Liptrot, C. H.; Willis, R. H.; Tapiolas, D. M.; Wright, A. D.; Motti, C. A. *J. Nat. Prod.* **2011**, *74*, 65–68.
 74. (a) Bradshaw, T. D.; Stevens, M. F. G.; Westwell, A. D. *Curr. Med. Chem.* **2001**, *8*, 203–210. (b) O'Brien, S. E.; Browne, H. L.; Bradshaw, T. D.; Westwell, A. D.; Stevens, M. F. G.; Laughton, C. A. *Org. Biomol. Chem.* **2003**, *1*, 493–497.
 75. Karlsson, H. K.; Lincoln, P.; Westman, G. *Bioorg. Med. Chem.* **2003**, *11*, 1035–1040.
 76. For reviews, see: (a) Gupta, A.; Rawat, S. *J. Curr. Pharm. Res.* **2010**, *3*, 13–23. (b) Boyd, G. V. In *Science of Synthesis; Houben-Weyl Methods of Molecular Transformations*; Schaumann, E., Ed.; Thieme: Stuttgart, Germany, 2002; Vol. 11, pp. 481–492. (c) Boyd, G. V. In *Comprehensive Heterocyclic Chemistry*; Katritzky, A. R.; Rees, C. W.; Potts, K. T., Eds.; Pergamon Press: New York, 1984; Vol. 6, pp. 177–233. For recent articles, see: (d) Carpenter, R. D.; DeBerdt, P. B.; Lam, K. S.; Kurth, M. J. *J. Comb. Chem.* **2006**, *8*, 907–914. (e) Choi, S. J.; Park, H. J.; Lee, S. K.; Kim, S. W.; Han, G.; Choo, H.-Y. *P. Bioorg. Med. Chem.* **2006**, *14*, 1229–1235. (f) Bonnamour, J.; Bolm, C. *Org. Lett.* **2008**, *10*, 2665–2667. (g) Saha, P.; Ramana, T.; Purkait, N.; Ali, M. A.; Paul, R.; Punniyamurthy, T. *J. Org. Chem.* **2009**, *74*, 8719–8725. (h) Barbero, N.; Carril, M.; SanMartin, R.; Dominguez, E. *Tetrahedron* **2007**, *63*, 10425–10432. (i) Evindar, G.; Batey, R. A. *J. Org. Chem.* **2006**, *71*, 1802–1808. (j) Saha, P.; Ali, M. A.; Ghosh, P.; Punniyamurthy, T. *Org. Biomol. Chem.* **2010**, *8*, 5692–5699. (k) Bougrin, K.; Loupy, A.; Soufiaoui, M. *Tetrahedron* **1998**, *54*, 8055–8064. (l) Myllymäki, M. J.; Koskinen, A. M. P. *Tetrahedron Lett.* **2007**, *48*, 2295–2298, and reference cited.
 77. Wang, Y.; Sarris, K.; Sauer, D. R.; Djuric, S. W. *Tetrahedron Lett.* **2006**, *47*, 4823–4826.
 78. Chanda, K.; Maiti, B.; Yellol, G. S.; Chien, M-H.; Kuo, M-L.; Sun, C-M. *Org. Biomol. Chem.* **2011**, *9*, 1917–1926.
 79. (a) Chen, L.; Hsiao, Y-S.; Yellol, G. S.; Sun, C-M. *ACS Comb. Sci.* **2011**, *13*, 112–119. (b) Hsiao, Y-S.; Yellol, G. S.; Chen, L-H.; Sun, C-M. *J. Comb. Chem.* **2010**, *12*, 723–732.
 80. Lim, H-J.; Myung, D.; Lee, I. Y. C.; Jung, M-H. *J. Comb. Chem.* **2008**, *10*, 501–503.
 81. Huang, W.; Yang, G-F. *Bioorg. Med. Chem.* **2006**, *14*, 8280–8285.
 82. Radi, R.; Saletti, S.; Botta, M. *Tetrahedron Lett.* **2008**, *49*, 4464–4466.
 83. VanVliet, D. S.; Gillespie, P.; Scicinski, J. *Tetrahedron Lett.* **2005**, *46*, 6741–6743.
 84. Lin, S-Y.; Isome, Y.; Stewart, E.; Liu, J-F.; Yohannes, D.; Yu, L. *Tetrahedron Lett.* **2006**, *47*, 2883–2886.
 85. Lai, C.; Gum, R. J.; Daly, M.; Fry, H. F.; Hutchins, C.; Abad-Zapatero, C.; VonGeldern, T. W. *Bioorg. Med. Chem. Lett.* **2006**, *16*, 1807–1810.
 86. Al-Masoudi, A.; Al-Soud, Y. A.; Al-Salihi, N. J.; Al-Masoudi, N. A. *Chem. Heterocycl. Compd.* **2006**, *42*, 1377–1403.
 87. Haasnoot, J. G. *Coord. Chem. Rev.* **2000**, *200*, 131–185.
 88. (a) Genin, M. J.; Allwine, D. A.; Anderson, D. J.; Barbachyn, M. R.; Emmert, D. E.; Garmon, S. A.; Graber, D. R.; Grega, K. C.; Hester, J. B.; Hutchinson, D. K.; Morris, J.; Reischer, R. J.; Ford, C. W.; Zurenko, G. E.; Hamel, C. J.; Schaadt, R. D.; Stapert, D.; Yagi, B. H. *J. Med. Chem.* **2000**, *43*, 953–970. (b) Wamhoff, H. In *Comprehensive Heterocyclic Chemistry*; Katritzky, A. R.; Rees, C. W., Eds.; Pergamon: Oxford, 1984; Vol. 5, pp. 669–732. (c) Buckle, D. R.; Rockell, C. J. M.; Smith, H.; Spicer, B. A. *J. Med. Chem.* **1986**, *29*, 2262–2267. (d) Alvarez, R.; Velazquez, S.; San-Felix, A.;

- Aquaro, S.; De Clercq, E.; Perno, C. F.; Karlsson, A.; Balzarini, J.; Camarasa, M. J. *J. Med. Chem.* **1994**, *37*, 4185–4194.
89. Huisgen, R. In *1,3-Dipolar Cycloadditional Chemistry*; Padwa, A., Ed.; Wiley: New York, 1984, Vol. 1, pp. 1–176.
 90. Rostovtsev, V. V.; Green, L. G.; Fokin, V. V.; Sharpless, K. B. *Angew. Chem. Int. Ed.* **2002**, *41*, 2596–2599.
 91. Tornøe, C. W.; Christensen, C.; Meldal, M. *J. Org. Chem.* **2002**, *67*, 3057–3064.
 92. (a) Castagnolo, D.; Dessì, F.; Radi, M.; Botta, M. *Tetrahedron: Asymmetry* **2007**, *18*, 1345–1350. (b) Castagnolo, D.; Radi, M.; Dessì, F.; Manetti, F.; Saggi, M.; Meleddu, R.; De Logu, A.; Botta, M. *Bioorg. Med. Chem. Lett.* **2009**, *19*, 2203–2205.
 93. (a) Munteanu, M.; Choi, S.; Ritter, H. *Macromolecules* **2008**, *41*, 9619–9623. (b) Munteanu, M.; Choi, S.; Ritter, H. *J. Incl. Phenom. Macrocycl. Chem.* **2008**, *62*, 197–202. (c) Choi, S.; Munteanu, M.; Ritter, H. *J. Polym. Res.* **2009**, *16*, 389–394.
 94. Pore, V. S.; Aher, N. G.; Kumar, M.; Shukla, P. K. *Tetrahedron* **2006**, *62*, 11178–11186.
 95. Bew, S. P.; Brimage, R. A.; L’Hermite, N.; Sharma, S. V. *Org. Lett.* **2007**, *9*, 3713–3716.
 96. (a) Rijkers, D. T. S.; Wilma van Esse, G.; Merckx, R.; Brouwer, A. J.; Jacobs, H. J. F.; Pieters, R. J.; Liskamp, R. M. J. *Chem. Commun.* **2005**, *36*, 4581–4583. (b) Ballell, L.; van Scherpenzeel, M.; Buchalova, K.; Liskamp, R. M. J.; Pieters, R. J. *Org. Biomol. Chem.* **2006**, *4*, 4387–4394.
 97. Joosten, J. A. F.; Tholen, N. T. H.; Ait El Maate, F.; Brouwer, A. J.; Wilma van Esse, G.; Rijkers, D. T. S.; Liskamp, R. M. J.; Pieters, R. J. *Eur. J. Org. Chem.* **2005**, 3182–3185.
 98. Lucas, R.; Neto, V.; Bouazza, A. H.; Zerrouki, R.; Granet, R.; Krausz, P.; Champavier, Y. *Tetrahedron Lett.* **2000**, *49*, 1004–1007.
 99. (a) Bouillon, C.; Meyer, A.; Vidal, S.; Jochum, A.; Chevolut, Y.; Cloarec, J. P.; Praly, J. P.; Vasseur, J. J.; Morvan, F. *J. Org. Chem.* **2006**, *71*, 4700–4702. (b) Géci, I.; Filichev, V. V.; Pedersen, E. B. *Chem. Eur. J.* **2007**, *13*, 6379–6386.
 100. Cravotto, G.; Mendicuti, F.; Martina, K.; Tagliapietra, S.; Rabaldo, B.; Barge, A. *Synlett* **2008**, *17*, 2642–2646.
 101. Ooya, T.; Inoue, D.; Soo Choi, H.; Kobayashi, Y.; Loethen, S.; Thompson, D. H.; Ho Ko, Y.; Kim, K.; Yui, N. *Org. Lett.* **2006**, *8*, 3159–3162.
 102. Lipshutz, B. H.; Taft, B. R. *Angew. Chem. Int. Ed.* **2006**, *45*, 8235–8238.
 103. Guezguez, R.; Bougrin, K.; El Akri, K.; Benhida, R. *Tetrahedron Lett.* **2006**, *47*, 4807–4811.
 104. El Akri, K.; Bougrin, K.; Balzarini, J.; Faraj, A.; Benhida, R. *Bioorg. Med. Chem. Lett.* **2007**, *17*, 6656–6659.
 105. (a) Vecchi, A.; Melai, B.; Marra, A.; Chiappe, C.; Dondoni, A. *J. Org. Chem.* **2008**, *73*, 6437–6440. (b) Marra, A.; Vecchi, A.; Chiappe, C.; Melai, B.; Dondoni, A. *J. Org. Chem.* **2008**, *73*, 2458–2461.
 106. Krim, J.; Sillahi, B.; Taourirte, M.; Rakib, E. M.; Engels, J. W. *Arkivoc* **2009**, *xiii*, 142–152.
 107. Locos, O. B.; Heindl, C. C.; Corral, A.; Senge, M. O.; Scanlan, E. M. *Eur. J. Org. Chem.* **2010**, 1026–1028.
 108. Malkoch, M.; Schleicher, K.; Drockenmuller, E.; Hawker, C. J.; Russell, T. P.; Wu, P.; Fokin, V. V. *Macromolecules* **2005**, *38*, 3663–3678.
 109. Isobe, H.; Fujino, T.; Yamazaki, N.; Guillot-Nieckowski, M.; Nakamura, E. *Org. Lett.* **2008**, *10*, 3729–3732.
 110. Ortega-Muñoz, M.; Lopez-Jaramillo, J.; Hernandez-Mateo, F.; Santoyo-Gonzalez, F. *Adv. Synth. Catal.* **2006**, *348*, 2410–2420.
 111. Thomas, J. R.; Liu, X.; Hergenrother, P. J. *J. Am. Chem. Soc.* **2005**, *127*, 12434–12435.
 112. Kaval, N.; Ermolat’ev, D.; Appukkuttan, P.; Dehaen, W.; Kappe, C. O.; Van der Eycken, E. *J. Comb. Chem.* **2005**, *7*, 490–502.
 113. Broggi, J.; Kumamoto, H.; Berteina-Raboin, S.; Nolan, S. P.; Agrofoglio, L. A. *Eur. J. Org. Chem.* **2009**, 1880–1888.
 114. Broggi, J.; Joubert, N.; Díez-González, S.; Berteina-Raboin, S.; Zevaco, T.; Nolan, S. P.; Agrofoglio, L. A. *Tetrahedron* **2009**, *65*, 1162–1170.

115. Pisaneschi, F.; Cordero, F. M.; Lumini, M.; Brandi, A. *Synlett* **2007**, *18*, 2882–2884.
116. Moorhouse, A. D.; Moses, J. E. *Synlett* **2008**, *14*, 2089–2092.
117. Beckmann, H. S. G.; Wittmann, V. *Org. Lett.* **2007**, *9*, 1–4.
118. (a) Ankati, H.; Biehl, E. *Tetrahedron Lett.* **2009**, *50*, 4677. (b) Akubathini, S. K.; Biehl, E. *Tetrahedron Lett.* **2009**, *50*, 1809–1811.
119. (a) Hansen, S. G.; Jensen, H. H. *Synlett* **2009**, *20*, 3275–3278. (b) Gao, Y.; Lam, Y. *Org. Lett.* **2006**, *8*, 3283–3285. (c) Kocalka, P.; Andersen, N. K.; Jensen, F.; Nielsen, P. *ChemBioChem.* **2007**, *8*, 2106–2116.
120. Balducci, E.; Bellucci, L.; Petricci, E.; Taddei, M.; Tafi, A. *J. Org. Chem.* **2009**, *74*, 1314–1321.
121. Lietard, J.; Meyer, A.; Vasseur, J. J.; Morvan, F. *J. Org. Chem.* **2008**, *73*, 191–200.
122. Rasmussen, L. K.; Boren, B. C.; Fokin, V. V. *Org. Lett.* **2007**, *9*, 5337–5339.
123. Pradere, U.; Roy, V.; McBrayer, T. R.; Schinazi, R. F.; Agrofoglio, L. A. *Tetrahedron* **2008**, *64*, 9044–9051.
124. Tsai, C. W.; Yang, S. C.; Liu, Y. M.; Wu, M. J. *Tetrahedron* **2009**, *65*, 8367–8372.
125. (a) Katritzky, A. R.; Singh, S. K.; Meher, N. K.; Doskocz, J.; Suzuki, K.; Jiang, R.; Sommen, G. L.; Ciaramitaro, D. A.; Steel, P. J. *Arkivoc* **2006**, *v*, 43–62. (b) Mayot, E.; Charbonnier, C. G.; Selve, C. J. *Fluorine Chem.* **2005**, *126*, 715–720. (c) Veverkova, E.; Toma, S. *Chem. Pap.* **2005**, *59(5)*, 350–353. (d) Andrade, M. M.; Barros, M. T. *Arkivoc* **2009**, *xi*, 299–306. (e) Al-Zaydi, K. M. *Ultrasonics Sonochem.* **2009**, *16*, 805–809.
126. Wang, Y.; Sarris, K.; Sauer, D. R.; Djuric, S. W. *Tetrahedron Lett.* **2007**, *48*, 2237–2240.
127. (a) Khankischpur, M.; Kurz, T. *Eur. J. Org. Chem.* **2008**, 6029–6033. (b) Meng, J.; Kung, P. P. *Tetrahedron Lett.* **2009**, *50*, 1667–1670. (c) Tian-Bao, L.; Wen-Qing, J.; Jian-Ping, Z.; Run-Sheng, Z. *Chin. J. Chem.* **2006**, *24*, 1609–1611.
128. Yeung, K. S.; Farkas, M. E.; Kadow, J. F.; Meanwell, N. A. *Tetrahedron Lett.* **2005**, *46*, 3429–3432.
129. Aldrich, L. N.; Lebois, E. P.; Lewis, L. M.; Nalywajko, N. T.; Niswender, C. M.; Weaver, C. D.; Conn, P. J.; Lindsley, C. W. *Tetrahedron Lett.* **2009**, *50*, 212–216.
130. (a) Dolzhenko, A. V.; Pastorin, G.; Dolzhenko, A. V.; Chui, W. K. *Tetrahedron Lett.* **2009**, *50*, 2124–2128. (b) Kshirsagar, A.; Toraskar, M. P.; Kulkarni, V. M.; Dhanashire, S.; Kadam, V. *Int. J. Chem. Tech. Res.* **2009**, *1*, 696–701. (c) Al-Soud, Y. A.; Al-Masoudi, N. A.; Loddo, R.; Colla, P. L. *Arch. Pharm. Chem. Life Sci.* **2008**, *341*, 365–369. (d) Kahveci, B.; Ozil, M.; Serdar, M. *Heteroatom Chem.* **2008**, *19*, 38–42. (e) Li, D.; Bao, H.; You, T. *Heterocycles* **2005**, *65*, 1957–1962. (f) Reichelt, A.; Falsey, J. R.; Rzasas, R. M.; Thiel, O. R.; Achmatowicz, M. M.; Larsen, R. D.; Zhang, D. *Org. Lett.* **2010**, *12*, 792–795.
131. (a) Jochims, J. C. In *Comprehensive Heterocyclic Chemistry II*; Katritzky, A. R.; Rees, C. W.; Scriven E.F.V., Eds.; Elsevier Science: Oxford, 1996, pp. 179–228. (b) Sperandio, D.; Tai, V. W.-F.; Lohman, J.; Hirschbein, B.; Mendonca, R.; Lee, C.-S.; Spencer, J. R.; Janc, J.; Nguyen, M.; Beltmann, J.; Sprengeler, P.; Scheerens, H.; Lin, T.; Liu, L.; Kellogg, A.; Green, M. J.; McGrath, M. E. *Bioorg. Med. Chem. Lett.* **2006**, *6*, 4085–4089. (c) Oruc, E. E.; Rollas, S.; Kandemirli, F.; Shvets, N.; Dimoglo, A. S. *J. Med. Chem.* **2004**, *47*, 6760–6767. (d) Dobrota, C.; Codruta, C.; Ioana, D. P.; Matache, M.; Baciuc, I.; Ruta, L. L. *Tetrahedron Lett.* **2009**, *50*, 1886–1888, and the references cited therein. (e) Leung, D.; Du, W.; Hardouin, C.; Cheng, H.; Hwang, I.; Cravatt, B. F.; Boger, D. L. *Bioorg. Med. Chem. Lett.* **2005**, *15*, 1423–1428. (f) Augustine, J. K.; Akabote, V.; Hegde, S. G.; Alagarsamy, P. *J. Org. Chem.* **2009**, *74*, 5640–5643.
132. (a) Khmelnitsky, L. I.; Rakitin, O. A. In *Comprehensive Heterocyclic Chemistry II*; Katritzky, A. R.; Rees, C. W.; Scriven, E. F. V., Eds.; Pergamon: Oxford, 1996; Vol. 2, pp. 433–452. (b) Rakitin, O. A. In *Comprehensive Heterocyclic Chemistry III*; Katritzky, A. R.; Ramsden, C. A.; Scriven, E. F. V.; Taylor, R. J. K., Eds.; Elsevier: Oxford, 2008; Vol. 6, pp. 1–36. For examples of 1,3,4-thiadiazole synthesis, see: (c) Kaleta, Z.; Makowski, B. T.; Soos, T.; Roman Dembinski, R. *Org. Lett.* **2006**, *8*, 1625–1628. (d) Kilburn, J. P.; Lau, J.; Jones, R. C. F. *Tetrahedron Lett.* **2003**, *44*, 7825–7828. (e) Polshettiwar, V.; Varma, S. R. *Tetrahedron Lett.* **2008**, *49*, 879–883.

133. Adib, M.; Jahromi, A. M.; Tavoosi, N.; Mahdavi, M.; Bijanzadeh, H. R. *Tetrahedron Lett.* **2006**, *47*, 2965–2967.
134. Rostamizadeh, S.; Ghaieni, H. R.; Aryan, R.; Amani, A. M. *Tetrahedron* **2010**, *66*, 494–497.
135. Sangshetti, J. N.; Chabukswar, A. R.; Shinde, D. B. *Bioorg. Med. Chem.* **2011**, *21*, 444–448.
136. Baxendale, I. R.; Ley, S. L.; Martinelli, M. *Tetrahedron* **2005**, *61*, 5323–5349.
137. Efimova, Y. A.; Karabanovich, G. G.; Artamonova, T. V.; Koldobskii, G. I. *Russian J. Org. Chem.* **2009**, *45*, 631–632.
138. (a) Åberg, V.; Das, P.; Chorell, E.; Hedenström, M.; Pinkner, J. S.; Hultgren, S. J.; Almqvist, F. *Bioorg. Med. Chem. Lett.* **2008**, *18*, 3536–3540. (b) Nelso, D. W.; Greg, R. J.; Kort, M. E.; Perez-Medrano, A.; Voight, E. A.; Wang, Y.; Grayson, G.; Namvic, M. T.; Donnelly-Roberts, D. L.; Nifratos, W.; Honore, P.; Jarvis, M. F.; Faltynek, C. R.; Carroll, W. A. *J. Med. Chem.* **2006**, *49*, 3659–3666. (c) Lima, M. L.; Eliezer, J. B. *Curr. Med. Chem.* **2005**, *12*, 23–49. (d) Herr, R. J. *Bioorg. Med. Chem.* **2002**, *10*, 3379–3393. (e) LaVoie, E. J. *Chem. Rev.* **1996**, *96*, 3147–3176.
139. Bladin, J. A. *Ber.* **1885**, *18*, 2907–2912.
140. (a) Amantini, D.; Beleggia, R.; Fringuelli, F.; Pizzo, F.; Vaccaro, L. *J. Org. Chem.* **2004**, *69*, 2896–2898. (b) Kivrakidou, O.; Brase, S.; Hulshorst, F.; Griebenow, N. *Org. Lett.* **2004**, *6*, 1143–1146. (c) Shie, J.-J.; Fang, J.-M. *J. Org. Chem.* **2003**, *68*, 1158–1160. (d) Demko, Z. P.; Sharpless, K. B. *Angew. Chem. Int. Ed.* **2002**, *41*, 2110–2113. (e) Demko, Z.; Sharpless, K. B. *Org. Lett.* **2002**, *4*, 2525–2527.
141. (a) Athanassopoulos, C. M.; Garnelis, T.; Vahliotis, D.; Papaioannou, D. *Org. Lett.* **2005**, *7*, 561–564. (b) Grajkowaska, E.; Wroblewski, J. T.; Yamamoto, T.; Bzdega, T.; Wroblewska, B.; Neale, J. H. *J. Med. Chem.* **2004**, *47*, 1729–1738. (c) Pandey, N.; Meyyappan, M.; Vasella, A. *Helv. Chim. Acta* **2000**, *83*, 513–538. (d) Batey, R. A.; Powell, D. A. *Org. Lett.* **2000**, *2*, 3237–3240.
142. Lukyanov, S. M.; Bliznets, I. V.; Shorshnev, S. V.; Aleksandrov, G. G.; Stepanov, A. E.; Vasil'ev, A. A. *Tetrahedron* **2006**, *62*, 1849–1863.
143. Shie, J.-J.; Fang, J.-M. *J. Org. Chem.* **2007**, *72*, 3141–3144.
144. Nayak, M.; Batra, S. *Tetrahedron Lett.* **2010**, *51*, 510–516.
145. Schmidt, B.; Meid, D.; Kieser, D. *Tetrahedron* **2007**, *63*, 492–496.
146. Efimova, Y. A.; Artamonova, T. V.; Koldobskii, G. I. *Russian J. Org. Chem.* **2010**, *46*, 612–614.
147. Couri, M. R.; Luduvico, I.; Santos, L.; Alves, R.; Pradob, M. A.; Gil, R. F. *Carbohydr. Res.* **2007**, *342*, 1096–1100.
148. Tang, Q.; Gianatassio, R. *Tetrahedron Lett.* **2010**, *51*, 3473–3476.

COVALENT AND NON-COVALENT COMPLEXES BETWEEN AROMATIC CARBOCYCLIC AND HETEROCYCLIC NUCLEOPHILIC AND ELECTROPHILIC REAGENTS

Luciano Forlani and Carla Boga

Dipartimento di Chimica Organica "A. Mangini", ALMA MATER STUDIORUM-Universita' di Bologna, Viale del Risorgimento 4, I-40136 Bologna, Italy (e-mail: luciano.forlani@unibo.it; carla.boga@unibo.it)

Abstract. Both electrophilic and nucleophilic aromatic substitution reactions proceed through a multistep pathway summarized as follows:

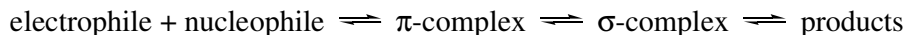

The observation of separate steps and the characterization of non-covalent and covalent complexes is strongly dependent on the nature of starting materials, belonging to both, heterocyclic and carbocyclic aromatic series, and on the experimental conditions with particular attention to solvent. For reactions carried out between superelectrophilic and supernucleophilic reagents, a new class of σ complexes, contemporaneously Wheland and Meisenheimer complexes, has been isolated and characterized.

Contents

1. Introduction
 2. Non-covalent interactions
 - 2.1. Electrophilic aromatic substitution
 - 2.2. Nucleophilic aromatic substitution
 3. Covalent interactions
 - 3.1. Covalent complexes in S_EAr reaction
 - 3.1.1. The azo-coupling reaction is a reversible process
 - 3.2. Covalent complexes in S_NAr reaction
 - 3.3. New complexes: the Wheland-Meisenheimer complexes
 4. Conclusions
- References

1. Introduction

In studies on reaction mechanisms, in particular of multistep reactions between neutral or charged species, the formation and the characterization of non-covalent and covalent complexes is of fundamental importance to elucidate (and compare) reaction pathways, also in the field of extensively studied reactions of organic chemistry. Our interest lies on the interactions between nucleophilic and electrophilic reagents in substitution reactions, labelled as nucleophilic aromatic substitution reactions and electrophilic aromatic substitution reactions. These reactions are usually considered on activated carbocyclic aromatic rings, but the more interesting findings may be obtained using heterocyclic compounds bearing cycles (or substituents) activating their reactivity towards opportune partners.

The isolation or the characterization of intermediates, in both kinds of reaction, completes the knowledge of mechanistic aspect of these reactions. Often, these intermediates (such as σ , covalent complexes) are only supposed without the support of experimental evidence.

Schemes 1, 2, 3 and 4 report the usually accepted reaction pathways of electrophilic aromatic substitution (S_EAr) (Schemes 1 and 2) and of nucleophilic aromatic substitution (S_NAr) (Schemes 3 and 4).

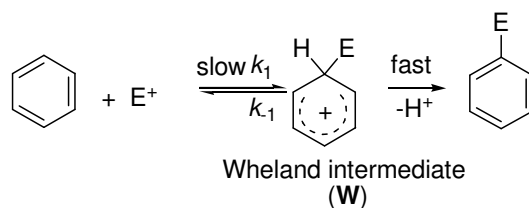

Scheme 1

Scheme 1 shows a simplified reaction pathway, usually reported in textbooks devoted to undergraduate students, involving the electrophilic species on the attack on the nucleophilic species in a rate-determining step followed by the re-aromatization step which is considered a fast step.

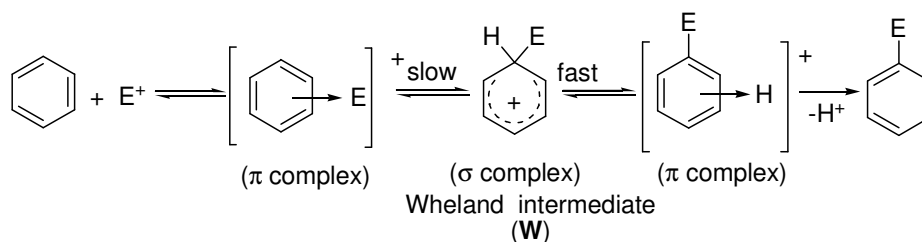

Scheme 2

Scheme 2 reports the same pathway with the addition of the first approach between the two reagents by a simple attraction, mainly electrostatic in character. From this π complex (non-covalent) the reagents choose the position of attack to form a σ bond producing the σ complex. A similar π complex involves the proton departure.

The Figure 1 reports the picture of the plot of potential energy toward the reaction coordinate for the reaction pathway shown in Scheme 2 regarding the electrophilic aromatic substitution.

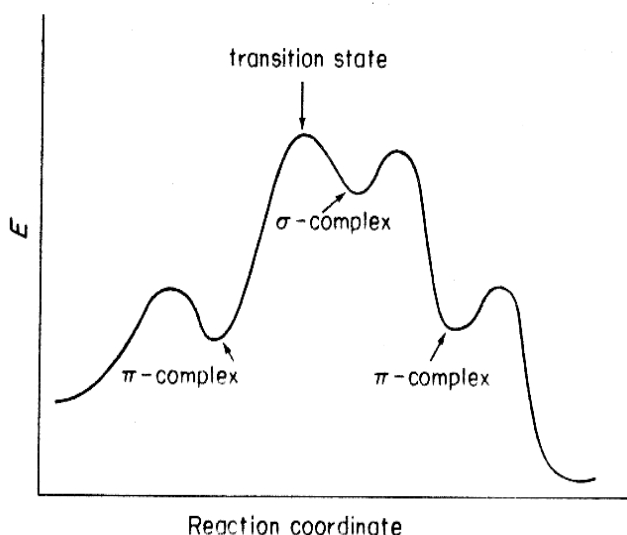
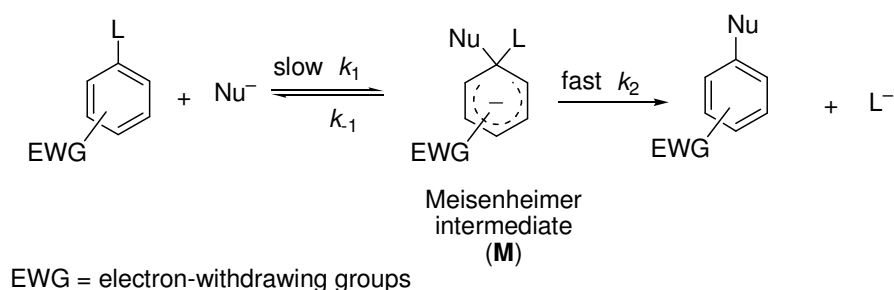

Figure 1

Figure 1 is a simplified description of the pathway of the electrophilic aromatic substitution in which two π complexes are considered: the first involving aromatic substrate and electrophilic reagent, the second one involving aromatic reaction products and the proton.

An instance of lack of mechanistic knowledge is offered by the reactivity of stable σ cationic complexes obtained by the reactions between 1,3,5-tris(*N,N*-dialkylamino)benzenes and diazonium salts. The generally accepted mechanism for the $S_{E}Ar$ (Scheme 1) indicates the proton departure from the Wheland intermediate (**W**) as a fast step, which is indicated to be the “driving force” of the $S_{E}Ar$ reaction. Isolation and stability of **W** intermediates, recently reported by us (see Section 3 below), indicates that this statement is not always correct. Our system reveals that the fast step is the attack of the electrophilic reagent to afford the **W** complex while the rate-determining step is that regarding the proton departure from **W**, as clearly indicated also by the observed base catalysis from **W** to the final product.

Scheme 3 reports the usual mechanism which is considered to be operating in $S_{N}Ar$ reactions between neutral substrates and charged nucleophilic reagents in polar/protic solvents.



Scheme 3

Scheme 4 reports the mechanism of $S_{N}Ar$ reactions carried out with neutral nucleophiles (amines, alcohols, *etc.*) and neutral substrates to form a zwitterionic intermediate (**ZW**).

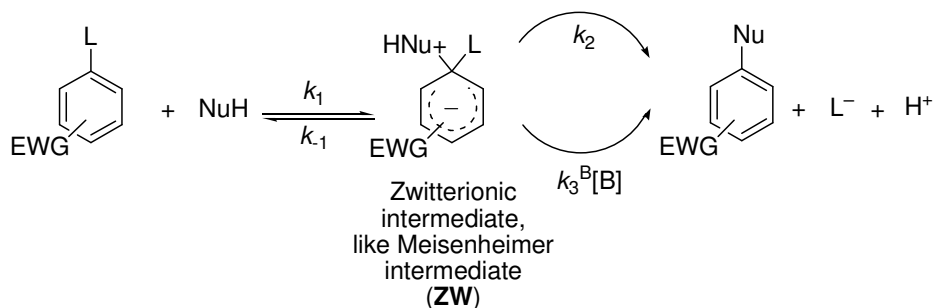

Scheme 4

From **ZW** the substitution products are obtained by two main reactions pathways: the spontaneous elimination of the leaving group (L) and of the proton and a base catalyzed process in which the base B favours the proton departure from the ammonium nitrogen (in the case of an amine as nucleophile), as depicted in Scheme 5.

The presence of a base catalyzed process indicated by k_3^B (Scheme 4) is considered an indirect evidence of the presence of the zwitterionic species **ZW** on the reaction pathway.

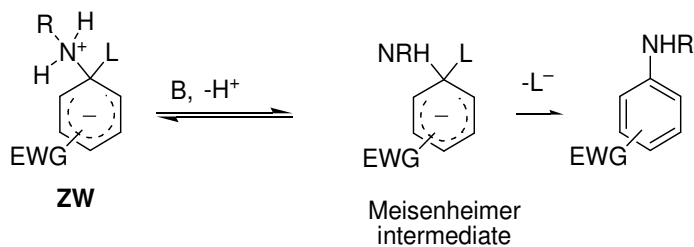

Scheme 5

In both kinds of reaction, S_{EAr} and S_{NAr} , the two-step mechanism involves a σ complex with a sp^3 carbon atom which is the centre of the attack of the partner.

In S_{EAr} reaction, the σ complex is named Wheland intermediate (**W**) and in S_{NAr} reaction the σ complex is named Meisenheimer intermediate (**M**).

The importance of the π complexes preceding the formation of σ complexes on the reaction pathway is the first subject of the present discussion.

2. Non-covalent interactions

In a lot of reactions, interactions without formation of σ bonds (non-covalent interactions) often occur when electrophilic reagents contact nucleophilic reagents. This interaction is indicated as a donor-acceptor interaction which may reach an actual charge transfer interaction.^{1,2}

Solvents may intervene in forming the complex by a pre-equilibrium, by competing with one of partners, depending on its nature.^{3,4}

These interactions afford molecular complexes with different stoichiometric ratio of partners in an equilibrium which is quickly established (at the limit of the diffusion rate), without involving activation energies, but the formation of complexes may be regulated by differences in entropy between complexed and non-complexed species, involving also different solvation energies (and related entropies).

2.1. Electrophilic aromatic substitution

The possibility to have interactions between electron-rich donors, including alkenes and aromatic hydrocarbons, and electrophilic reagents such as nitronium ion (NO_2^+) was an exciting hypothesis⁵ (well confirmed by experimental findings) which, in electrophilic aromatic substitution reactions, added a step preceding the formation of the Wheland intermediate (**W**), as reported in Scheme 6, where **D-A** is a donor-acceptor complex, a kind of complexes known from long time.^{6,7}

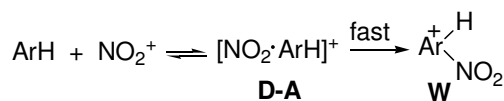

Scheme 6

A well-known instance of donor-acceptor complexes is that regarding halogenation^{8,9} (mainly bromination and chlorination) of olefins, in which the formation of a **D-A** complex occurs in the first step of the reaction of addition of halogens to alkenes, or, more in general, of the electrophilic addition to the carbon-carbon double bond.¹⁰

Scheme 7 reports a picture of the probable pathway in bromination reaction of the double bond.^{11,12}

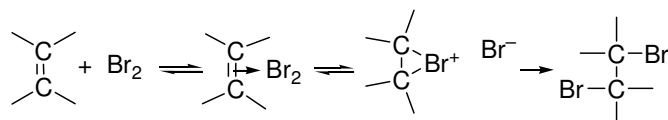

Scheme 7

Of course, the energy level of reactants is not concerning the separated starting species (as usually conceived), but it is that required after the formation of **D-A** in a pre-equilibrium step.

Interesting investigations, indicating the presence of **D-A** complexes, involved a particular olefin, adamantyleneadamantane (Scheme 8) which cannot form saturated compounds so stopping the reaction to the bromonium ion.¹¹

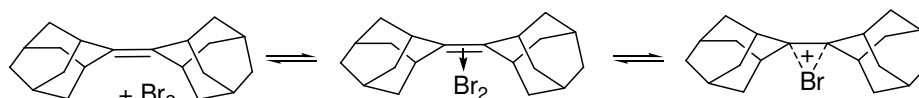

Scheme 8

Usually, **D-A** complexes are coloured and they are observed to have characteristic absorption bands in the visible region of the spectrum. The Benesi-Hildebrand spectrophotometric method¹² provides to evaluate their stability constant.

Photochemical processes related to the excitation of charge transfer complexes were studied⁵ through picosecond time-resolved spectroscopy to indicate the importance of these processes in nitration of arenes.

2.2. Nucleophilic aromatic substitution

In S_NAr reactions carried out in poorly polar solvents, with amines on nitro-halogen derivatives, the experimental rate constant increases on increasing the initial concentration value of the amine. This complex kinetic behaviour (ascribed to the presence of a base catalyzed proton abstraction on the zwitterionic intermediate)¹³ is explained by the usual two step mechanism involving the proton departure from the zwitterionic complex in a rate-limiting step, as reported in Schemes 4 and 5. Catalytic behaviour is mainly observed by using fluoroderivatives; chloro nitro activated derivatives show feeble enhancement of the reaction rate by increasing the initial concentration of the amine.

The proton transfer from a charged nitrogen atom to a neutral nitrogen atom (of amine groups) in a rate-limiting step was a questioned idea.

Usually, the presence of an overall reaction order different from 2 value, in a bimolecular reaction, is an indication of the presence of some equilibrium preceding the rate-limiting step.¹⁴

In principle, S_NAr reactions carried out by using charged or neutral nucleophiles in polar/protic solvents, show a kinetic behaviour related to a second order kinetic law, first in both reagents (Equation 1).

$$v = k_{\text{obs}} [S][\text{Nu}] \quad \text{Equation 1}$$

The same substrates react with neutral nucleophiles (mainly amines) in apolar solvents (toluene, benzene, chloroform,...) by following a different kinetic law, such as that reported by Equation 2.

$$v = k_{\text{obs}} [S][\text{Nu}]^n \quad \text{Equation 2}$$

where n is the experimental reaction order, different from 1 value¹⁵ (usually $n > 1$).

The experimental finding is that, in the reactions between nitro-activated halobenzenes and amines, under pseudo-monomolecular conditions with respect to the amine, $[\text{amine}] \gg [\text{substrate}]$, the k_{obs} value (in $\text{s}^{-1} \text{mol}^{-1} \text{dm}^3$) increases on increasing the initial amount of the amine. In some cases, the plot of k_{obs} values toward $[\text{amine}]_0$ (the initial concentration value of the amine) is linear. Further increase of the $[\text{amine}]_0$ values produces a saturation phenomenon as reported in plot of Figure 2, which is related to the reactions between 2,4-dinitro-fluorobenzene and butylamine (BU) in toluene at 21 °C; k_{obs} in $\text{s}^{-1} \text{mol}^{-1} \text{dm}^3$, $[\text{BU}]_0$ in mol dm^{-3} .¹⁶

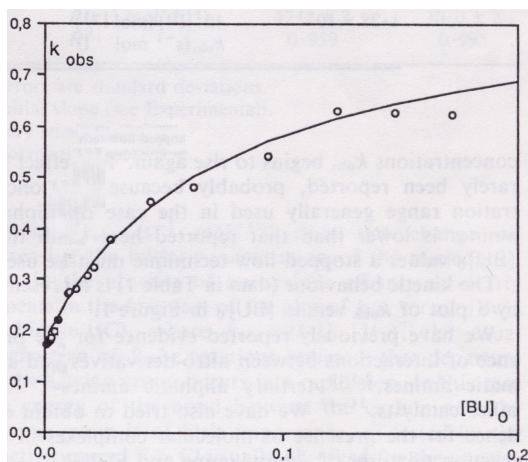

Figure 2

The usual data dissection of k_{obs} values is obtained by Equation 3 which is derived from Scheme 3.

$$v = k_0 + k_B [\text{amine}]_0 \quad \text{Equation 3}$$

The plot of k_{obs} versus $[\text{amine}]_0$ allows to evaluate the uncatalyzed process (as expressed by k_0) and the catalyzed process as expressed by k_B values. When k_{obs} values are plotted versus σ values by the Hammett equation, from the roughly linear plot the absurdous ρ value of -6.5 is obtained. The substituent effect in nucleophilic attack of substituted anilines on 2,4-dinitrofluorobenzene in ethanol affords $\rho = -4.0$.¹⁷ For the reaction of substituted anilines with 2,4-dinitrofluorobenzene in benzene at 25 °C, the plot of k_B (which is $k_1/k_{-1}/k_3$ of Scheme 4, data dissection by equation 3) versus σ values shows a similar ρ value of -6.4 .¹⁸ This very high negative ρ value cannot be explained by the proton abstraction (or HF abstraction) from the zwitterionic intermediate of Schemes 4 and 5.

In these reactions, the UV/Vis spectra, as well as ¹H NMR spectra, show evidence of the presence of a fast process affording a molecular complex, donor/acceptor like, which precedes the substitution process. These non-covalent interactions are mainly donor-acceptor and hydrogen bonding interactions.¹⁹

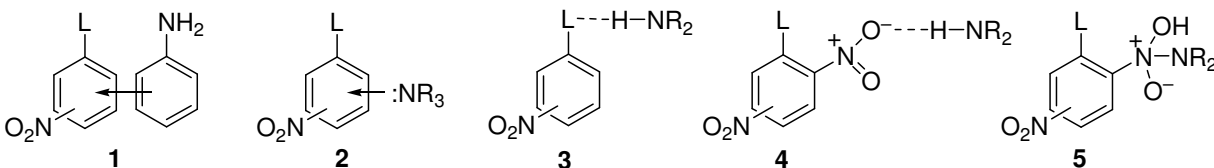
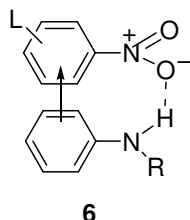

Chart 1

Chart 1 reports some possible non-covalent (**1–4**) or covalent (**5**) interactions between nitro activated substrates and amines.

In Chart 1, **1** and **2** present electron donor/acceptor interactions (π - π and π -n, respectively), in **3** and **4** there are mainly proton donor/acceptor interactions and **5** is a particular complex with a covalent interaction. The contemporaneous presence of different kinds of interaction, for instance electron donor/acceptor interaction and hydrogen bonding interaction (as reported in **6**), constitutes a complication to elucidate the actual nature of the interaction.



Feeble interactions between molecules of the same compound (self-association) or of compounds and solvent (solvation), or between two or more molecules of solute are of large interest to know the actual nature of reacting species and their energetic level.

Table 1. Stability constants¹⁹ of some molecular complexes^a between 2,4-dinitrofluorobenzene and amines (or catalyst) in solvents of low permittivity.

Amine	Solvent	K^{MC} ($\text{mol}^{-1}\text{dm}^3$)
Aniline	benzene	0.068
Aniline	chloroform	0.70
[² H]Aniline	chloroform	0.60 ^b
<i>N</i> -methylaniline	THF	1.0; 0.65 ^c
<i>p</i> -Methylaniline	THF	0.40; 0.31 ^c
<i>p</i> -Methoxyaniline	THF	1.2; 1.6 ^c
<i>m</i> -Methylaniline	THF	0.43; 0.16 ^c
<i>m</i> -Methoxyaniline	THF	0.20; 0.43 ^c
<i>p</i> -Chloroaniline	THF	0.46; 0.29 ^c
DABCO ^d	benzene	0.31; 0.31 ^c
Triethylamine	benzene	0.47
2-Pyridone	benzene	27 ^c
δ -Valerolactame	benzene	2.1 ^c
<i>n</i> -Butylamine	toluene	14 ^c
<i>n</i> -Butylamine	cyclohexane	27
Piperidine	cyclohexane	79
<i>n</i> -Butylamine	<i>n</i> -hexane	0.39
Di- <i>n</i> -butylamine	<i>n</i> -hexane	0.20
Tributylamine	<i>n</i> -hexane	0.043

^aCalculated from absorbance values at zero reaction time, unless otherwise indicated. ^bCalculated from ¹H NMR data. ^cCalculated from kinetic data. ^dDABCO=1,4-diaza[2.2.2]bicyclooctane.

When the reactions are fast, the inspection of the reaction mixtures at zero reaction time is performed with a stopped-flow apparatus with a fast wavelength scanner, revealing absorbance values in the UV/Vis spectrum which are not referable neither to starting materials nor to reaction products (which are not yet formed). The absorbance values may be used in standard equations to evaluate the apparent constant (K) of the interaction related to the absorbance value recorded. This interaction was measured also by ^1H NMR spectral data and K^{MC} (MC means molecular complex) values agree (within experimental errors) to values obtained by UV/Vis spectroscopic data or to those calculated from kinetic data by usual equations.

From K^{MC} values of Table 1, it is possible to deduce some interesting considerations. Aromatic amines interacts with electron discharged substrates probably by both, π - π and π -n interactions (see Chart 1), as tested by some substituent effects. Obviously, aliphatic amines interactions are mainly π -n interactions and hydrogen bonding interactions, as tested by the fact that K^{MC} values, are depressed on going from primary to secondary and tertiary amine. In agreement with high catalytic power, 2-pyridone and δ -valerolactame shows very high K^{MC} values, probably explained by strong hydrogen bonding interactions.

A further observation concerns the solvent effect. Clearly, a π donor solvent (such as benzene or toluene) competes with the amine in π - π interactions. In strongly polar solvents, because of their dissociating power, the molecular complexes cannot be observed and the base catalyzed process is, usually, absent.

The presence of complexes in a poorly polar solvent modifies the polarity of the immediate neighborhood of the substrate; the consequence is that, in apolar solvent, the complexed substrate is more reactive than the “free” substrate.

In fact, by considering the two pathways of Scheme 9, the data dissection affords a $\rho = -2.8$ for the electronic effect of substituent in the aniline¹⁸ concerning K^{MC} values, in agreement with a donicity of the aniline towards the discharged substrate and the attack of the substituted aniline to fluoro derivative complexed by the same aniline agrees with the calculated¹⁹ $\rho = -3.6$. The formation of the reaction products by the catalyzed pathway is the sum of the two electronic effects on the separate steps.

In addition, we considered the electronic effect on the aniline, carried out by an external base unable to react with the 2,4-dinitrofluorobenzene, but able to complex the substrate. In this case k_{B} values (according to “classical” mechanism depicted in Schemes 4 and 5), are a measure of the proton abstraction from the zwitterionic intermediate formed in a previous step by the reacting aniline. The bases used to catalyze the reaction were DABCO, *N,N*-dimethylaniline and triethylamine. If the non reactive base catalyzes the proton abstraction from the zwitterionic intermediate **ZW**, the simple proton abstraction process indicated in the transition state **ZW1** should show a ρ value positive (or zero): when X is an electron-withdrawing group, it favours the proton elimination, while when X is an electron-donating group this process is depressed. On the contrary, a ρ value of -4.9 was calculated.¹⁸ This value strongly indicates that, in the pathway catalyzed by the unreactive amine, the nucleophilic power of the reacting amine is important, as required by Scheme 9.

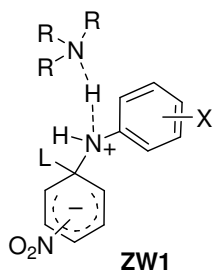

When the base catalysis is operative, as reported in Scheme 5, the return back to starting materials (k_{-1} in Scheme 3) is a easier process that the HL departure. Hence the idea that the proton abstraction reduces the zwitterionic complex to an usual σ -anionic complex with a more fast leaving group departure. The usual trend of base catalysis is that the fluoro derivatives show large dependence of the apparent rate of the substitution reaction from the enhancing of the initial concentration of the used amine, while other leaving groups show feeble dependence of this rate. The conclusion is that fluoride ion is the worst leaving group with respect to other halides. This conclusion strongly conflicts with experimental data. In fact, the dissection of experimental data allows to extrapolate the rate of the uncatalyzed process which involves the usual ratio k_1k_2/k_{-1} of Scheme 3. For processes involving the only nucleophilic attack on the substrate, we do not know one only inversion of the trend $F \gg Cl$. The ratio F/Cl is in the range from 100 to 2000.²⁰ Clearly, fluoride is a better leaving group than other halides. The explanation of kinetic behaviour by base catalysis in fluoride derivatives implies the poor nucleofugality of the fluoride ion (with respect to other halides) from the zwitterionic intermediate which needs of a second molecule of base.

We emphasize that the mechanism of Scheme 9 explains a lot of experimental observations hardly explained by mechanisms involving proton abstraction in a rate determining step.

Our evidences^{20,21a} strongly support the idea that the observed molecular complexes between the electron-rich reagent (the amine) and the poorly charged aromatic nitro derivative is on the reaction coordinate of the substitution process, as depicted in Scheme 9.

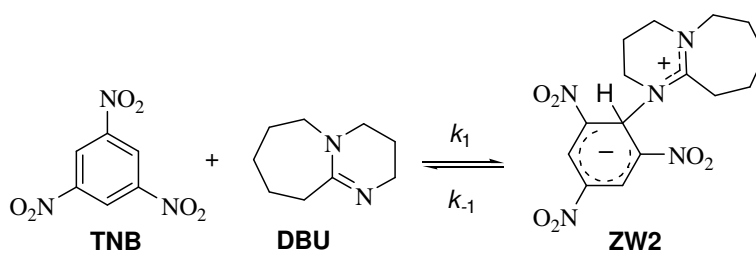
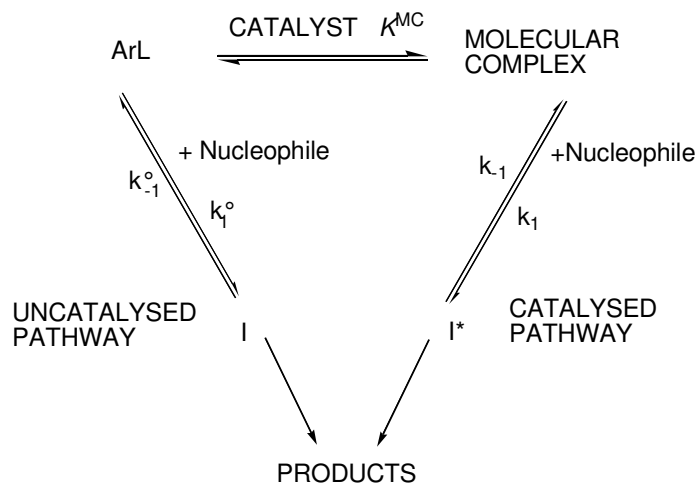

In agreement to Scheme 9, when the leaving group on the activated substrate is absent and when the amine does not possess protons, in poorly polar solvents as in the case of the reaction between 1,3,5-trinitro-

benzene (**TNB**) and 1,8-diazabicyclo[5.4.0]undec-7-ene (**DBU**) reported in Scheme 10, the formation of the zwitterionic complex shows (in toluene) autocatalytic behaviour (k_{obs} is increased on increasing the initial concentration value of **DBU**), which cannot be explained by base catalysis^{21b,22} (both, leaving group and proton are absent!), but which is explained by introducing the simple Scheme 11 on the reaction pathway, where **D-A** is the donor acceptor molecular complex.

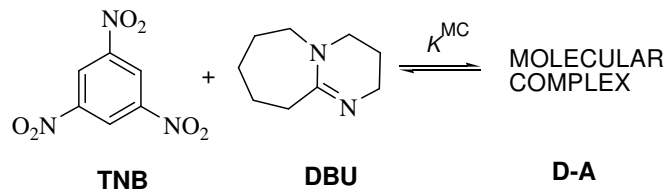

Scheme 11

Similar behaviour was observed by using quinuclidine and DABCO,²² which nucleophilicity was recently investigated by Mayr by using benzhydrylium ions.²³

Another instance of “anomalous” kinetic behaviour is related to the reaction between trinitrofluorobenzenes and substituted benzyl alcohols²⁴ of Scheme 12.

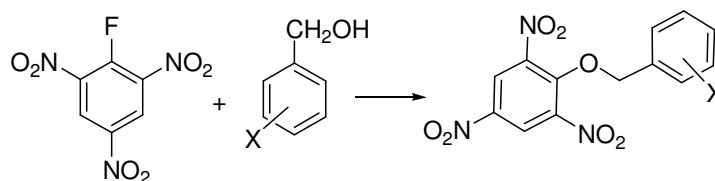

Scheme 12

Also for the substitution reaction (performed in neutral medium) of Scheme 12, k_{obs} values increase on increasing the initial concentration of benzyl alcohols. UV/Vis spectrophotometric data (at zero reaction times) reveals the presence of a donor acceptor interaction between the two reagents.

The kinetic behaviour of reaction of Scheme 12 may be hardly explained by the proton abstraction from oxonium ion **ZW3** because the pK_a values of oxonium is very high and a slow process to proton abstraction in the presence of excess of alcohol is a fantasious idea.

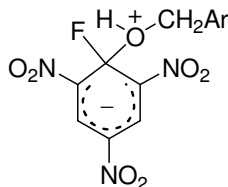

ZW3

The observed kinetic behaviour is easily explained by a pathway similar to that of Scheme 9.

Also in this case the effect of the increase of the temperature in nucleophilic aromatic substitution in poorly polar solvent by using amines as nucleophiles is in agreement with Scheme 9.

Usually, the rate of these reactions increases on increasing the temperature, owing the concept of barrier due to the activation energy, in agreement to Arrhenius law. The uncatalyzed process follows this

general law. On the contrary, there are instances, in apolar solvents, of the opposite behaviour. By increasing the temperature, catalyzed process decreases his rate of obtainment of products.²⁵

For the very simple reaction of Schemes 10 and 11, k_{obs} value decreases on increasing the temperature.²² Clearly, the effect of the temperature concerns two separate steps on the reaction pathway of Schemes 10 and 11:

a) the pre-association of the reagents which is a process which is depressed by the increase of the temperature, because it is dependent only on the entropic variation between separate partners and the partners in the molecular complex (Scheme 11).

b) the attack of the nucleophile on the complexed substrate (Scheme 10).

In other words, the association between the substrate (**TNB**) and **DBU** is depressed by the increase of the temperature, as usual in the association to form non covalent complexes.

The increase of the temperature enhances the importance of the non-catalyzed process because the K_{MC} value is depressed by the enhancement of the temperature.

The self-association of the amine is used to explain some rate depression observed by increasing the temperature. But invoking as explanation the self-association of **DBU** appears to be an incorrect explanation.

In conclusion, the leaving group effect, the substituent electronic effect on the nucleophile, the effect of the increase of the temperature, the kinetic behaviour in the absence of leaving group and of the proton are subjects strongly supporting the mechanism of Scheme 9 in contrast with the mechanism of Schemes 4 and 5 involving the proton abstraction in a rate-determining step.

Furthermore, while evidences of the presence of the zwitterionic complex **ZW1** (by using substrates bearing fluorine atom as leaving group) are not reported in the literature, the presence of complexes between electron-rich and electron-discharged reagents is a well known interaction, which is clearly present in the reaction mixtures, as tested also by the data of Table 1.

We emphasize that in $S_{\text{N}}\text{Ar}$ reaction, the presence of donor/acceptor complexes⁶ was proposed to enhance the reactivity of substrate in solvents of low permittivity. The fact that the so-called base catalysis was not observed in the reactions carried out in strongly polar solvents is easily related to the interactions between solvents and reagents. In apolar solvents, the reagents are prone to change the microscopic neighboring of partners with the consequence to enhance the rate of the substitution process in which the separation of the charges is higher in the transition state with respect to the starting reagents.

Really, both terms “substrate” and “reagent” are conventional in character (see below). In practice, the same behaviour observed in the so-called nucleophilic substitution reactions may be observed in electrophilic substitution reactions too.

3. Covalent interactions

Searches (including isolation or observation and characterization) about intermediates of the usual ionic reactions on aromatic substrates, nucleophilic ($S_{\text{N}}\text{Ar}$) or electrophilic ($S_{\text{E}}\text{Ar}$) substitution reactions are of great importance not only to confirm the proposed mechanism (usually, the “two steps” mechanism of both reactions) but also to investigate their reactivity in isolated steps of both $S_{\text{N}}\text{Ar}$ or $S_{\text{E}}\text{Ar}$ reactions.

In fact, the major part of mechanistic studies starts from measures involving the overall rate of multi-steps reactions. This fact implies some assumptions and simplifications which, in principle, might be incorrect and even dangerous to the complete elucidation of the reaction pathway.

When kinetic studies on these reactions ($S_{E}Ar$ or $S_{N}Ar$) are carried out, both complexes, non-covalent and covalent ones, are often contemporaneously present to complicate the observed kinetic feature of studied processes.

The use of strongly activated molecules²⁶ as nucleophilic reagents (supernucleophiles) allows the investigation of separate steps in the field of the aromatic electrophilic substitution reactions.

The used supernucleophiles at neutral carbon atom are compounds bearing strong electron-donating groups in conjugated position as 1,3,5-tris(*N,N*-dialkylamino)benzenes **7–10** or 1,3,5-trimethoxybenzene **11** (Chart 2). In addition, aromatic heterocycles bearing two amino groups (see the thiazole derivative **12**) are strong carbon nucleophilic reagents.

Carbon supernucleophilic reagents

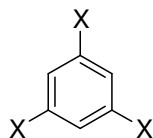

X = piperidinyl (**7**)
 X = morpholinyl (**8**)
 X = pyrrolidinyl (**9**)
 X = *N,N*-dimethylamino (**10**)
 X = methoxy (**11**)

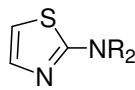

NR₂ = NH₂

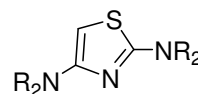

NR₂ = pyrrolidinyl (**12**)

Carbon superelectrophilic reagents

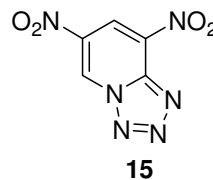
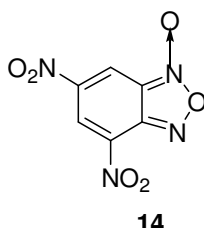
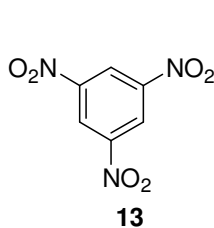
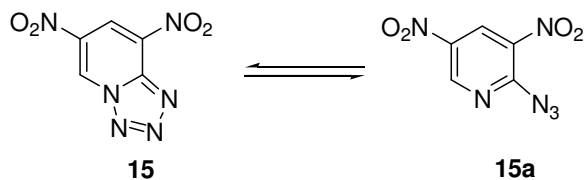

Chart 2

Among superelectrophilic reagents (to investigate the intermediates in $S_{N}Ar$ reactions), we used some aromatic carbocyclic nitro-activated derivatives such as 1,3,5-trinitrobenzene (**13**) or aromatic heterocyclic derivatives such as 4,6-dinitrobenzofuroxane (**14**) and 4,6-dinitrotetrazolopyridine (**15**) shown in Chart 2.



Scheme 13

Scheme 13 shows the equilibrium between the two forms,²⁷ 4,6-dinitrotetrazolopyridine (**15**) and his azido form **15a**. In fact, 4,6-dinitrotetrazolopyridine may exist also in the azido (non cyclic) form. The dependence of the ratio between **15** and **15a** from the solvent is reported in Table 2.²⁷ Tetrazolopyridine **15** is a very strong electrophilic reagent, while the azide **15a** is moderately activated toward nucleophilic reagents. In isolated σ complexes, the azido form is absent.

Table 2. Relative percentage of 4,6-dinitrotetrazolopyridine (**15**) with respect to the azidic form **15a** in deuterated solvents.²⁷

Solvent	% of form 15
CDCl ₃	0
CD ₂ Cl ₂	10
(CD ₃) ₂ CO	60
CD ₃ CN	70
(CD ₃) ₂ SO	94

3.1. Covalent complexes in S_EAr reaction

In the electrophilic aromatic substitution reaction, the Wheland intermediates (**W**) are usually accepted to be on the coordinate of the reaction, but a few evidence of their effectiveness, together with their characterization and investigation on the chemical behaviour, are reported in the literature.²⁸

Usually, the S_EAr reactions are carried out by generating *in situ* the electrophilic reagent which often is an elusive species arising by some equilibria and present in low concentration. In addition, the medium of these reactions is complicated by the presence of different species both acid and basic, in large amount.

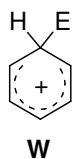

The formation of **W** (which is indicated as a rate-determining step according to Scheme 1) occurs after the equilibrium producing electron donor acceptor complexes (π complexes).²⁹

The observation and characterization of Wheland complexes is a rare experimental feature, because, usually, Wheland intermediates are supposed to exist in very low concentration as the steady-state theory requires, but, when strong electron-donating groups are bonded to the aromatic carbocyclic or heterocyclic ring, isolation or spectroscopic observation and characterization of σ complexes, Wheland complexes, was possible. The first evidence and characterization of Wheland intermediate in azo-coupling reactions was obtained³⁰ by performing the reactions between 1,3,5-tris(*N,N*-dialkylamino)benzenes and arenediazonium salts, directly in the NMR spectroscopy tube, as depicted in Scheme 14.

Product of the azo coupling reaction may be obtained as free base from its salts spontaneously or with addition of a tertiary amine, respectively. These complexes were characterized mainly by NMR spectroscopy and they are moderately stable, so they can be prepared in solution by adding the reagents in equimolar ratio. In this way, the following step, concerning the proton expulsion from **W** complex and the re-aromatization of the ring, may be studied as an isolate step.

In the case of the reactions carried out in the absence of base and with equimolar ratio of starting reagents, **W** is produced in almost quantitative yields in a fast step which is followed by the formation of usual azo coupling products in a slow step, despite of the energetic gain, in the re-aromatization process, which is usually claimed to be the driving force of the electrophilic aromatic substitution reaction.³¹

Plot of Figure 3 is an instance of the variation of the experimental rate constant (calculated by a first order rate law) by increasing the initial concentration of an unreactive base acting as a catalyst. The value of the re-aromatization step may be extrapolated at zero concentration of the catalyst.

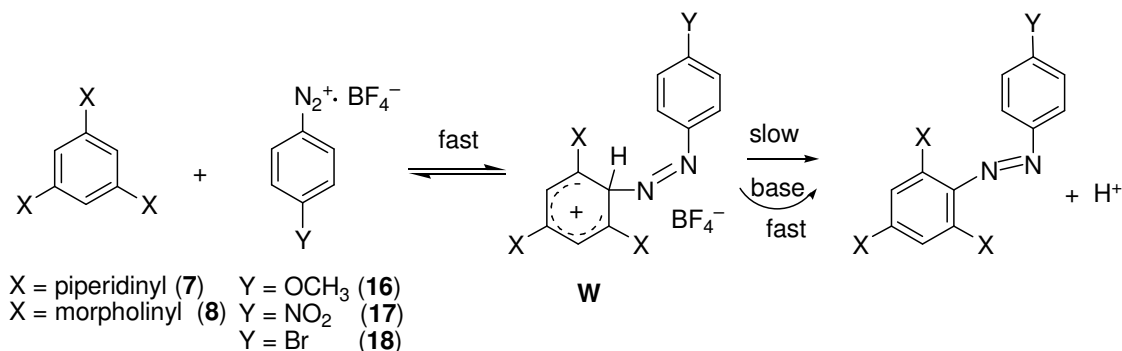

Scheme 14

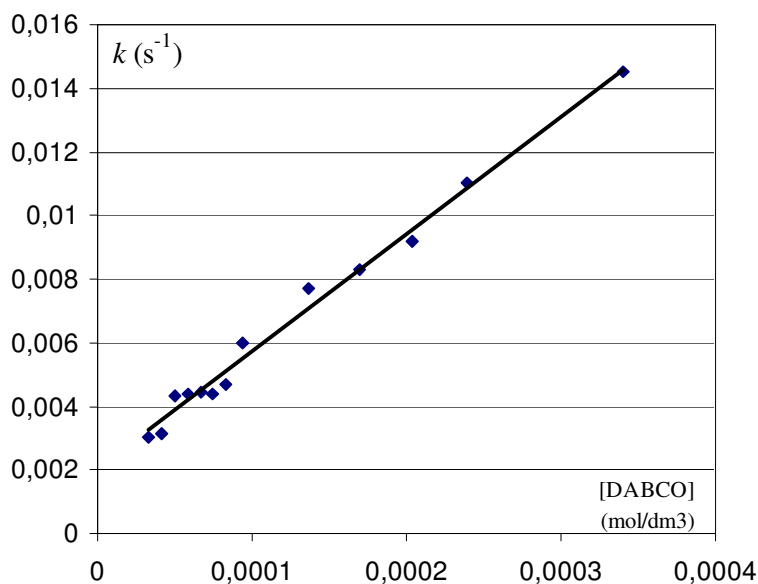

Figure 3. Plot of concentration of DABCO and the rate constant of the reaction of formation of the azo-derivative from the corresponding σ complex (Wheland complex) obtained by reaction of tris (*N*-piperidiny)benzene (7) and *p*-methoxybenzenediazonium tetrafluoroborate (16) in acetonitrile at 20 °C.³¹

We measured the obtainement of the reaction products in both processes, uncatalyzed and catalyzed, of Scheme 14, and the dissections of the experimental data for the used bases are reported in Table 3.

k_2 value is depending on the basic power of the catalyst. pKa values (in acetonitrile) are also reported in Table 3. k_2 Value depends on the pKa value by following the usual Brønsted equation (β is the Brønsted coefficient).

$$\text{Log}_{10} k_2 = \beta \text{ pKa} + C \quad \text{Equation 4}$$

The Equation 4 becomes equation 5:

$$\text{Log}_{10} k_2 = 0.36 \times \text{pKa} + (-4.93) \quad \text{Equation 5}$$

Table 3. k_0 e k_2 values for uncatalyzed and catalyzed processes of Scheme 14, respectively, for reactions between 1,3,5-tris(*N*-piperidinyl)benzene and *p*-methoxybenzenediazonium tetrafluoroborate and amines used as catalyst, in acetonitrile at 20 °C.³¹

Amine	pKa ^a	10 ³ x k_0 (s ⁻¹)	k_2 (s ⁻¹ mol ⁻¹ dm ³)	k_2/k_0
Pyridine	12.33	0.123	0.15	1.2x10 ³
Imidazole	14.2	0.242	3.32	1.4x10 ⁴
Morpholine	16.61	0.710	14.6	2.1x10 ⁴
DABCO	18.29	2.10	37.1	1.8x10 ⁴
Triethylamine	18.7	1.48	40.7	2.8x10 ⁴
Piperidine	18.92	0.71	54	7.6x10 ⁴
Quinuclidine	19.51	0.43	133	3.1x10 ⁵
Morpholine ^b	16.61	6.27	193	3.1x10 ⁴
DABCO ^c	18.29	1.68	21.7	1.3x10 ⁴

^aIn CH₃CN. ^bWheland complex obtained from 1,3,5-tris(*N*-piperidinyl)benzene (**7**) and *p*-nitrobenzenediazonium tetrafluoroborate (**17**). ^cWheland complex obtained from 1,3,5-tris(*N*-morpholinyl)benzene(**8**) and *p*-methoxybenzenediazonium tetrafluoroborate (**16**).

Figure 4 reports the plot of the Brønsted equation.

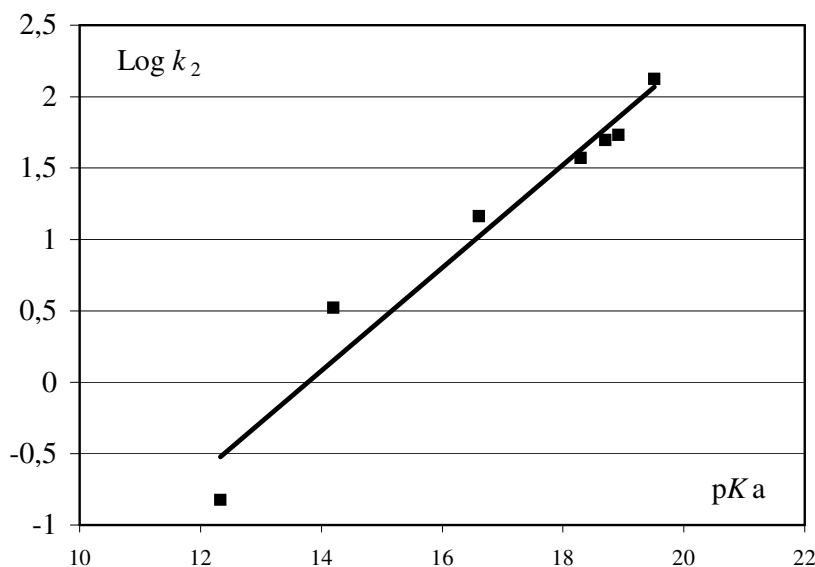

Figure 4. Plot of the $\log k_2$ versus the pKa value of the amine used as catalyst, obtained using the Brønsted equation.

The value of the slope of this plot (β value of the Equation 4) indicates that the proton transfer from the Wheland complex to the base proceeds through a transition state in which the proton is more near to the carbon of Wheland complex than to the nitrogen atom of the base acting as a catalyst. The ratio k_2/k_0 reported in Table 3 is a measure of the relative importance of the catalyzed (k_2) and non-catalyzed process. It is clear that the catalysis is a pathway strongly faster than the spontaneous process.

These conclusions explain the fact that the catalysis is rarely observed in aromatic electrophilic reaction. In fact, the usual experimental conditions of S_EAr implies the presence of large amount of

“catalyst” (counter ions of the electrophilic reagents, solvents or other substances used to form *in situ* the electrophilic reagent often in buffered medium): consequently, the catalyzed pathway collects the whole of the reactions and the obtainment of the final product by proton elimination, involving re-aromatization of the aromatic ring, results a fast process: but this process is an apparent spontaneous process.

UV/Vis and ^1H NMR spectroscopic observation of the reaction mixtures confirm that, under our experimental conditions (mainly in the absence of proton acceptor molecules), the formation of the σ -cationic complex is a fast process (the equilibrium of Scheme 14 is completely shifted toward the right and it is reached in short time (few seconds) but the spontaneous conversion of the Wheland intermediate into final azo compound requests 1–2 days to obtain 50% of conversion.

3.1.1. The azo-coupling reaction is a reversible process

Schemes 1 and 2 report the attack of the electrophilic reagent on the aromatic substrate to form a σ complex as a reversible process.³²

Few evidences of the reversible attack of the electrophilic reagent in $\text{S}_{\text{E}}\text{Ar}$ reactions are reported. The H/D exchange on benzene (and on its derivatives) in acidic medium is a clear reversible process passing through a Wheland like intermediate (Scheme 15).

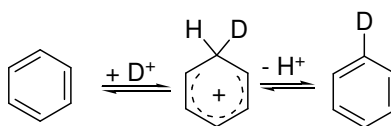

Scheme 15

In principle, the preliminar formation of the π complex (as reported in Scheme 2) is a reversible process, but the reversibility of the whole reaction may be discussed. Usually, sulfonation reaction of aromatic substrates is indicated to be a reversible process, as it is well-known in naphthalene chemistry.

The reaction between 1,3,5-tris(*N,N*-dialkylamino)benzenes and arene diazonium salts offers some details on the reversibility. Scheme 16 reports a picture of the investigated reactions.

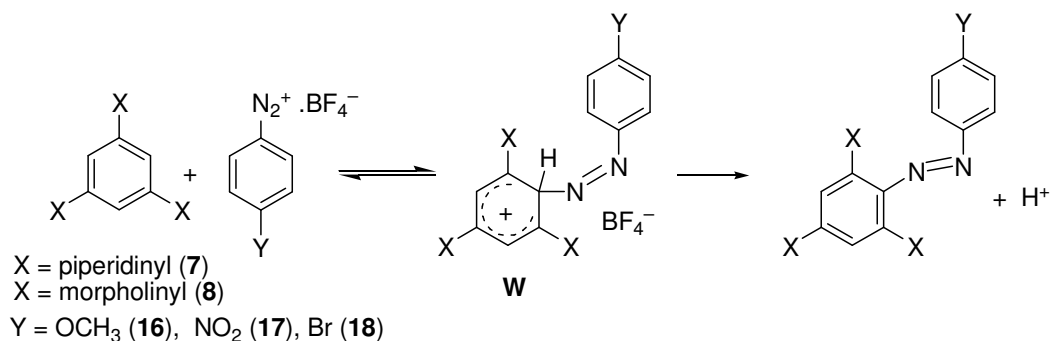

Scheme 16

We are reporting the collected evidences of the possibility of the return-back for both steps of Scheme 16. A first interesting behaviour that permitted to obtain information on the reaction of Scheme 16 was observed through ^1H NMR spectrum of the reaction mixture at low temperature.

When the reactions of Scheme 16 between tris(piperidinyI)benzene (**7**) and diazonium salt **17** is carried out in CD₃CN at $-30\text{ }^\circ\text{C}$, directly in the NMR spectroscopy tube, by adding solid starting reagents in

equimolar amount, **7** is partially dissolved and the only reaction product observed is the bis-azoderivative **19** (Scheme 17) together with a small amount of complex **W** (less than 5% of whole conversion). There is a double attack of the diazonium salts (in temporary excess) on the tris(amino)benzene affording the bis-aza derivative (as fluoborate salt).

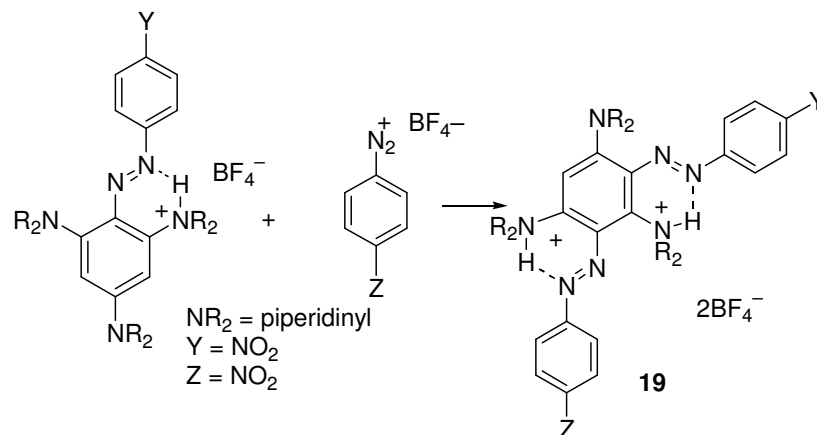

Scheme 17

1H NMR signals of **19** slowly disappear together with the solubilization of **7**. In about 10 minutes, the 1H NMR spectrum shows the only presence of the Wheland complex. The Scheme 18 is a reasonable explanation of this behaviour which involves the departure of a diazonium salt from **19** to **W**.

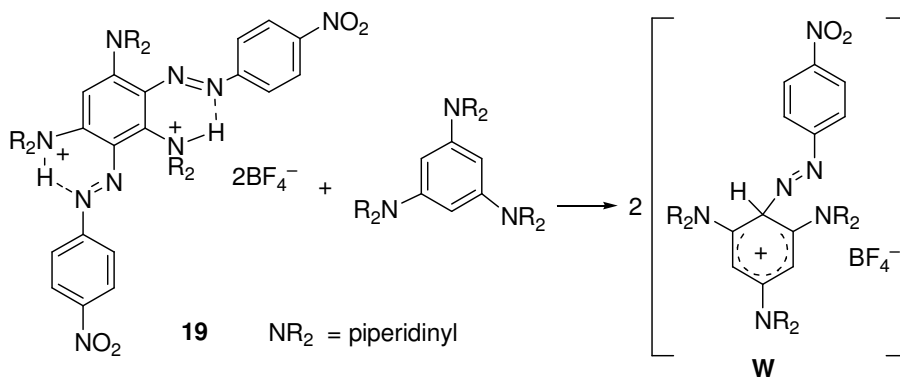

Scheme 18

The obtainment of a bis-azo derivative may induce to think that the second attack to be faster than the first one, but, clearly, the obtainment of bis derivative arises from the large defect of the compound **7**.

Further indications are obtained about the exchange of the diazonium salt on the Wheland complex. Scheme 19 reports the reaction of exchange of the diazonium cation starting from a Wheland complex obtained from a different diazonium salts. As expected, the more powerful electrophilic reagent expels the less powerful one. The less able electrophilic diazonium cation may replace the more able electrophilic cation in the Wheland complex if used in large amount. Clearly, there is an equilibrium on the first attack of the electrophilic reagent on the substrate. Further observations support the reversibility, as reported below. Scheme 20 reports the replacement of the electrophilic moiety from the related Wheland complex by a different kind of electrophilic reagent, the superelectrophile 4,6-dinitrobenzofuroxan (**DNBF**). There is the replacement of the diazonium moiety with a superelectrophilic reagent: from a Wheland complex to a Wheland/Meisenheimer complex (**W-M**) (see below).

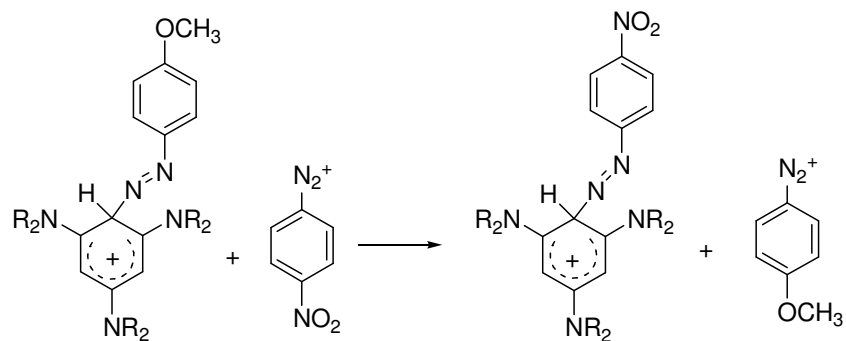

Scheme 19

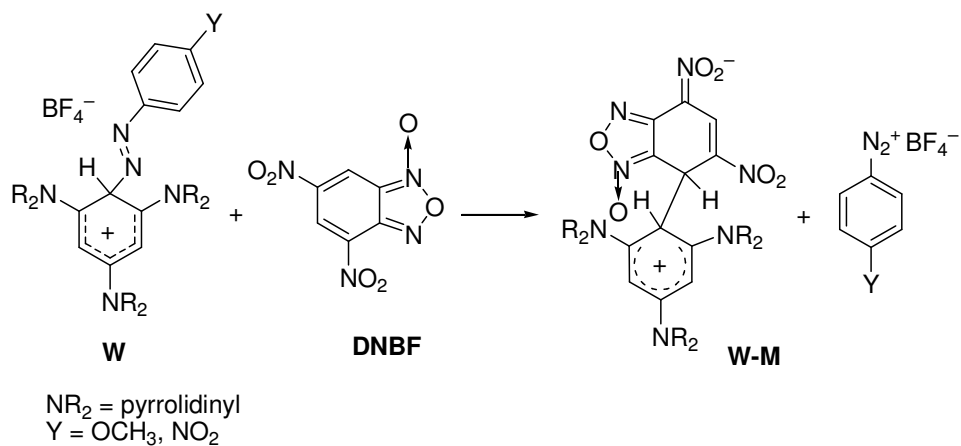

Scheme 20

The reaction of Scheme 20 is almost quantitative. Obviously, **DNBF** is a better electrophilic reagent than the diazonium cation. The replacement of the electrophilic moiety may be explained by the two main pathways reported in Scheme 21 and 22.

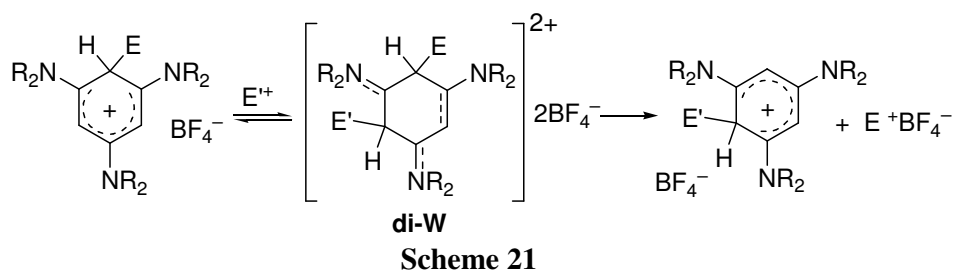

Scheme 21

The Scheme 21 concerns the formation of a bis azoderivative which is obtained by the reaction of Scheme 17. The second possible pathway is reported in Scheme 22. It concerns the departure of the first arenediazonium salt to return-back to the starting materials, followed by the addition of the second diazonium salt on the 1,3,5-tris(dialkylamino) benzene which is in equilibrium with the Wheland complex.

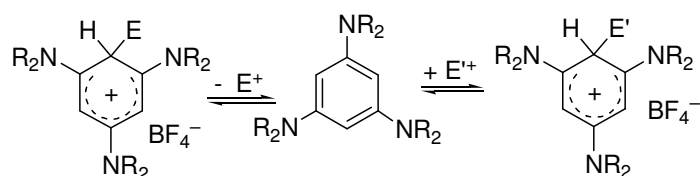

Scheme 22

In this case, the addition of the second electrophile occurs on one of the three equivalent positions of the starting tris(amino)benzene.

Since the three positions are equivalent in starting nucleophilic reagent, it was not possible to discriminate between the two pathways of Scheme 21 and 22. To have more information, we synthesized the asymmetric tris(amino)benzene [4,4'-(5-pyrrolidin-1-yl-1,3-phenylene)dimorpholine (**20**)] (see Scheme 23) with two non-equivalent positions. The reaction of Scheme 23 was performed in CD₃CN at -30 °C, in a NMR spectroscopy tube by using 4-methoxydiazonium salt **16**. The main product of the reaction was the σ complex in position 4 with respect to the pyrrolidinic ring, together with a small amount of the complex bearing the arenediazonium moiety in *ortho* position (with respect to the pyrrolidinic ring).

After complete formation of the σ -complex, a solution of 4-nitrobenzenediazonium tetrafluoroborate (**17**) was added to this reaction mixture: the ¹H NMR spectrum immediately showed new signals ascribed to the complex bearing the 4-nitrobenzene-diazonium moiety, together with those related to the leaving arenediazonium salt and, in a very small percentage, with the complex bearing the new entering electrophile in *ortho* position with respect to the pyrrolidinic ring. Obviously, the same complex was also obtained by direct reaction between 4,4'-(5-pyrroli-din-1-yl-1,3-phenylene)dimorpholine (**20**) and 4-nitrobenzenediazonium tetrafluoroborate (**17**).

As a consequence of reactions of Scheme 23, we are able to state that the replacement of the diazonium salt occurs at the same carbon atom, probably through the equilibrium of Scheme 22.

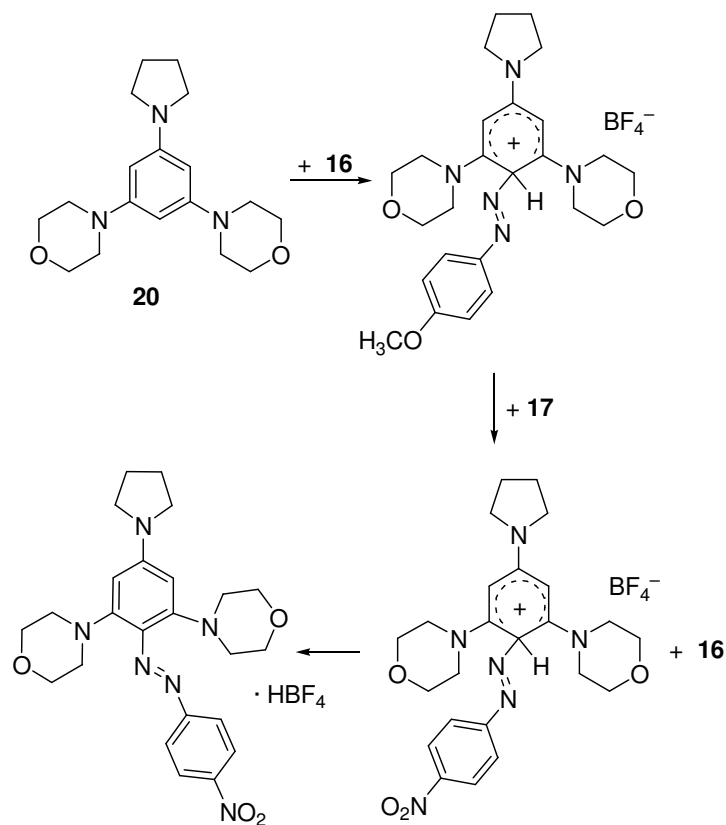

Scheme 23

Obviously, since the second more active electrophilic reagent (bearing the nitro group) is bonded to the same carbon atom of the first one, we can conclude that the pathway represented in Scheme 21 is poorly probable to illustrate the exchanges reported above. Other indication on the reversibility of the studied

reactions are obtained by the replacement of the nucleophilic moiety on a Wheland complex, as reported in Scheme 24. In this case, there is exchange of the less nucleophilic part (involving tris(*N*-morpholinyl) derivative) with the more powerful tris(piperidinyl) derivative of the σ complex. The reaction of Scheme 24 was carried out by adding a solution of **7** (in CD_3CN at $-30\text{ }^\circ\text{C}$) to a solution of the Wheland complex **21**. The ^1H NMR spectrum of the obtained mixture, recorded immediately after the addition of **7**, showed disappearance of signals related to **21** and concomitant appearance of those related to Wheland complex **22**, together with those of 1,3,5-tris(*N*-morpholinyl)benzene (**8**).

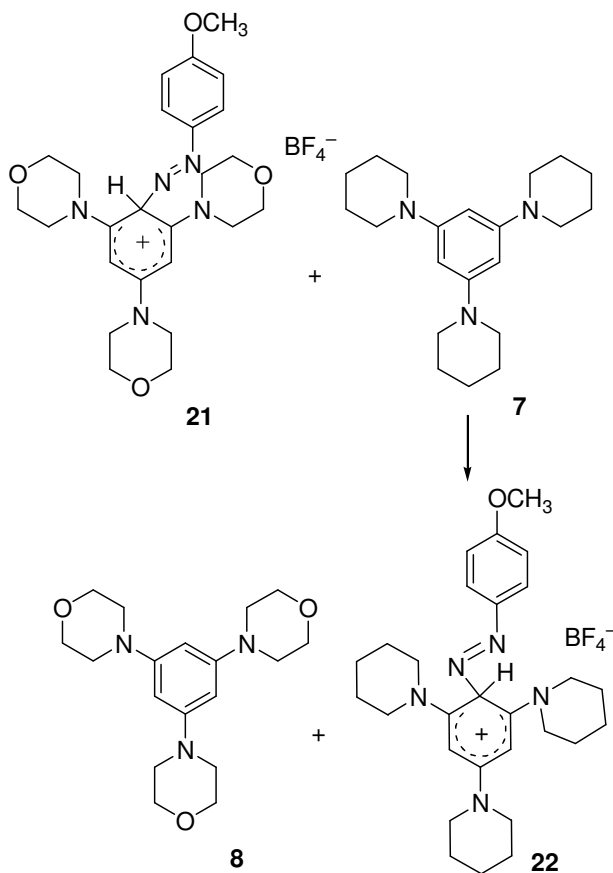

Scheme 24

The reaction of Scheme 24 is complete in about ten minutes; the inverse reaction between **22** and **8** did not produce the similar exchange: under our experimental conditions, **7** replaces **8** because it is the more powerful electron-donor substrate, but **8** is not able to replace **7**.

It is worthy of consideration that, when the reactivity of reagents is stressed as in this case (the 1,3,5-tris(*N,N*-dialkylamino)benzene system may be named a “carbon supernucleophilic reagent”), some aspects of the studied reactions are enhanced and grown-up to manifest effects and behaviours which are naked in more usual, less activated systems. And this is the case.

Now, we can summarize these findings producing the conclusion that the azo coupling reaction is a reversible process and the main points arising from the reported data are as follow.

i. The formation and destruction of the double attack product **19** (Scheme 17) and the reactions of Scheme 18, involving the departure of a diazonium salt from an azo compound, clearly indicates the complete reversibility of the process involving the second attack of the diazonium salt.

ii. Scheme 19 indicates that from **W** complexes, the less powerful electrophilic reagent 4-methoxy diazonium salt (**16**) is more easily lost than the more powerful electrophilic reagent 4-nitrobenzene-diazonium tetrafluoroborate (**17**). Consequently, by using this reaction, there is the possibility to draw an “electrofugality” scale.

iii. The data of Table 1 and the use of 4-[3-morpholino-5(1-pyrrolidinyl)phenyl]morpholine (**20**) strongly indicate that the displacement of the methoxy substituted diazonium cation by the more powerful electrophilic reagent (nitro- and bromo- substituted diazonium salt, as well as **DNFB**) occurs at the same carbon atom in two subsequent steps.

As a consequence, the displacement of diazonium cation from the Wheland complex is an easy process when the entering electrophile is a more powerful reagent than the leaving electrophile. In the same way, the more powerful nucleophilic reagent, 1,3,5-tris(*N*-piperidinyl)benzene (**7**) replaces the morpholino moiety.

iv. Even if the possibility of having an “ipso” attack of the second diazonium salt on the final azo coupling products cannot be completely ruled out, the lack of replacement reaction of diazonium salt from **23** and **24** (which reacts as depicted in Scheme 25 giving disubstituted compounds) indicates this pathway as unlikely.

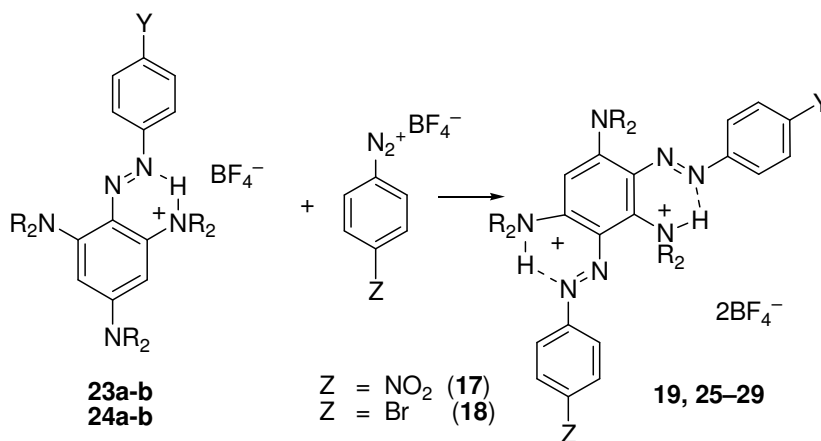

Y	Z	Compound	Y	Z	Compound
OCH ₃	–	23a	OCH ₃	–	24a
NO ₂	–	23b	OCH ₃	–	24a
NO ₂	NO ₂	19	NO ₂	NO ₂	27
OCH ₃	NO ₂	25	OCH ₃	NO ₂	28
OCH ₃	NO ₂	26	OCH ₃	Br	29
NR ₂ = piperidinyl			NR ₂ = morpholinyl		

Scheme 25

In conclusion, there are clear indications of the reversibility of this electrophilic aromatic substitution reaction. We emphasize that this is the first instance of the complete reversibility of an azo-coupling reaction. However, the systems and the reactions reported here are a particular piece of the electrophilic aromatic substitution reaction. The attempt to generalize the observation reported here to the whole $S_{\text{E}}\text{Ar}$ reactions may be justified. In fact, the usual experimental conditions of $S_{\text{E}}\text{Ar}$ reactions involve the presence of large amount of several kind of bases, exercising the base catalysis on the proton abstraction, which became a fast step, preventing the return back of the system.

3.2. Covalent complexes in S_NAr reaction

Covalent complexes (σ -anionic complexes, or Meisenheimer complexes, which may be zwitterionic complexes) occur by reaction between strongly activated aromatic (of both carbocyclic and heterocyclic series) and charged or neutral nucleophiles and they have been extensively investigated^{19,33–36} and reported by detailed reviews. Investigation of these complexes concerns their structures, spectral properties and details on their formation have been obtained from kinetic and thermodynamic data.

The interest on the study of σ -anionic complexes (or zwitterionic complexes) arises from the assumption of their effective existence in the S_NAr reactions, in which these complexes are supposed but not observed. In fact, when good leaving groups (such as halides) are bonded to the substrate, the corresponding Meisenheimer complexes, up to now, are not been characterized.

Electron-withdrawing groups (usually the nitro group, as well as the “aza” group in heterocyclic series) activate the aromatic nucleophilic substitution reactions in both carbocyclic and heterocyclic series and permit to have stable Meisenheimer complexes. While the isolation of σ complexes is not a frequent case, their investigation by different spectroscopic method is the more frequently used method for their characterization.

Our interest lies on some heterocyclic derivatives, as the case of the reactivity of 5-nitro-thiazole derivatives³⁷ or nitro-benzothiazole derivatives. In small aromatic rings, the electron-withdrawing force of the nitro group is enhanced by the localization of the negative charge, producing a major stability of the complexes than in six membered rings.

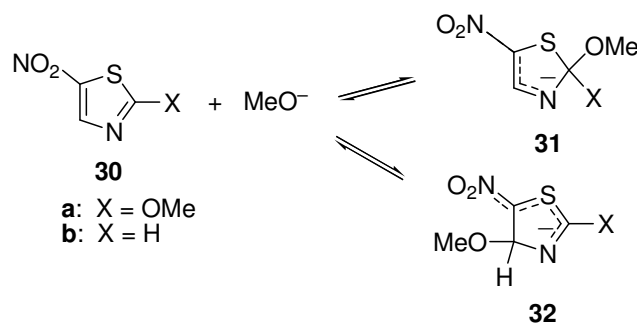

Scheme 26

Scheme 26 reports the reaction of the 5-nitro-2-methoxythiazole with sodium methoxide which was carried out in DMSO-d₆ and in deuterated methanol. The two Meisenheimer complexes of Scheme 26 are of comparable stability and their relative ratio is influenced by the used solvent: in methanol, only compound **32a** (X=OMe) was detected, while in DMSO **31a** and **32a** are contemporaneously present in the reaction mixtures. Probably, the attack of the nucleophile on the C4 bearing hydrogen atom is a faster process than the attack on the carbon atom bearing the methoxy group of **30a**. Compound **31b** is less stable and no evidence of it was observed.

Another interesting reaction of formation of simple Meisenheimer complexes is reported in Scheme 27. This Scheme reports the attack of a nucleophilic reagent arising from tetrabutylammonium borohydride³⁸ (TBABH). The same nucleophilic reagent was used in the reaction performed by using 1,3-dinitrobenzene and 1,3,5-trinitrobenzene.

Also in this case, kinetic data on the formation of complexes indicate that the attack of the nucleophile (and the stability of complexes) is strongly affected by the nature of solvent. In dimethylsulfoxide, the rate of formation of complexes from **30** (and also from 6-nitrobenzothiazole too) is lower than that observed in less polar solvent such as toluene and THF. There is a balance on the stabilization of the charge in starting material and in the transition states affording the complexes, in agreement with the fact that in the transition state the charge is more dispersed than in the starting situation.³⁹

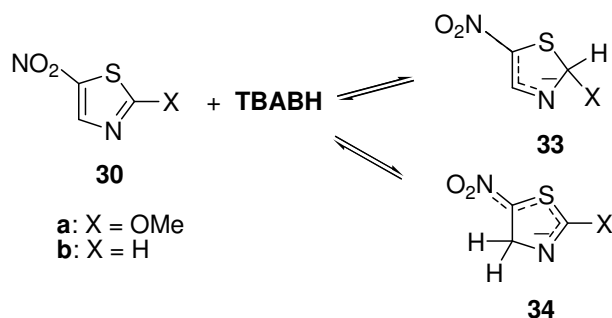

Scheme 27

In the case of nucleophiles acting at the neutral nitrogen atom (primary and secondary amines), the zwitterionic covalent complexes **ZW** are supposed to form, but they are not been observed: the corresponding anionic intermediates (**M**) are observed (Scheme 28).

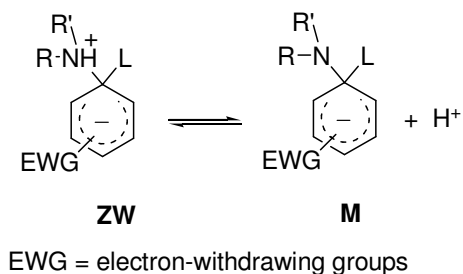

Scheme 28

When tertiary cyclic aliphatic amines are used, such as diazabicyclo[2,2,2]octane (**DABCO**), or quinuclidine (**QN**), with trinitrobenzene, the ¹H NMR spectrum shows evidence of the formation of the zwitterionic complex **ZW4**.

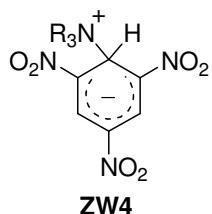

A particular situation is generated when the nitrogen atom does not have proton directly bonded such as in the case of 1,8-diazabicyclo[5,4,0]-undec-7-ene (**DBU**) or 1,5-diazabicyclo[4,3,0]-non-5-ene (**DBN**) which reacts with 1,3,5-trinitrobenzene as reported in Scheme 10.^{21,22}

The stability of the zwitterionic intermediate (**ZW2** in Scheme 10) arising from the attack of an sp^2 nitrogen atom indicates the importance, in determining the stability of complexes, not only of the delocalization of the negative charge of the complex, but also the delocalization of the positive charge supported by the entering nucleophilic reagent.^{22c,36}

Spectroscopic and kinetic investigation on the reaction of Scheme 29 clearly indicates the presence of the zwitterionic complex: its particular kinetic behaviour is previously discussed to elucidate the presence of the equilibrium donor/acceptor like, preceding the attack of the nucleophile, as an indication against the so-called “base catalyzed mechanism” in S_NAr reactions.

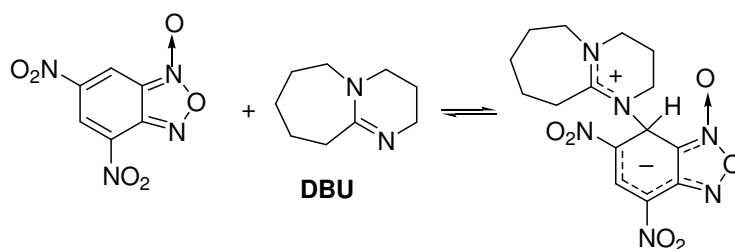

Scheme 29

The same reaction carried out by using a secondary amine shows (by 1H NMR spectral data in $DMSO-d_6$ and in $THF-d_8$) that the formation of the zwitterionic intermediate quickly affords the σ -anionic complex by fast proton departure, as reported in Scheme 30.

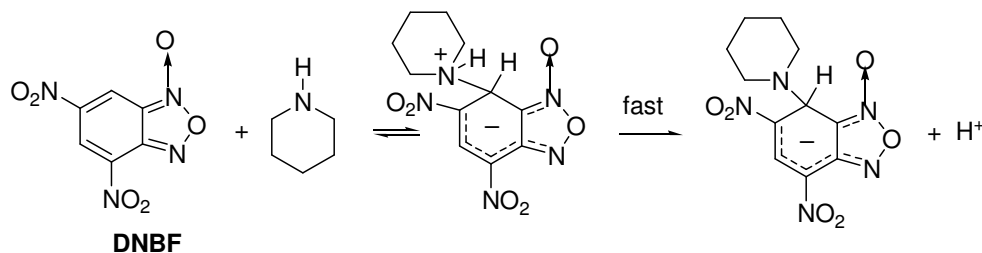

Scheme 30

A comparison of the relative stability of these complexes in THF shows that **DNBF** complexes are more stable than complexes with 1,3,5-trinitrobenzene (**TNB**<**DNBF**), in agreement with literature data.³⁷

In DMSO the inverse relative stability of the two complexes is observed: **TNB**>**DNBF**, probably because the more polar solvent (DMSO) is more prone to assist the charge separation than the less polar solvent THF.

3.3. New complexes: the Wheland-Meisenheimer complexes

It is known that Wheland complex stability is enhanced by the presence of a number of strong electron-donating groups, as well as Meisenheimer complex stability depends on the presence of strong electron-withdrawing groups. Consequently, we tried to perform a coupling reaction between two neutral partners bearing strong electron-donating groups and strong electron-withdrawing ones.

The result of the reaction between 1,3,5-tris(*N,N*-dialkylamino)benzenes and 4,6-dinitrobenzofuroxane (**DNBF**) is the quantitative formation of a double σ complex which is contemporaneously a Wheland and a Meisenheimer complex, as reported in Scheme 31. We named these complexes as Wheland-Meisenheimer (**W-M**) complexes.⁴⁰

At low temperature, the ^1H NMR signals related to protons bonded to the tris(amino)benzene moiety are two different signals for C12 and C14 because of the presence of the asymmetric carbon centre (C7) and the C2 centre. By raising the temperature from $-70\text{ }^\circ\text{C}$ to $-30\text{ }^\circ\text{C}$, the three signals ascribed to hydrogen atoms of the tris(amino)benzene moiety show line broadening because of an exchange process; at $+20\text{ }^\circ\text{C}$ the signals appear a single signal. There is a dynamic process, as reported in Scheme 32, which is a reversible process: by cooling the reaction mixture from room temperature to $-30\text{ }^\circ\text{C}$ the signals become identical to the starting signals.

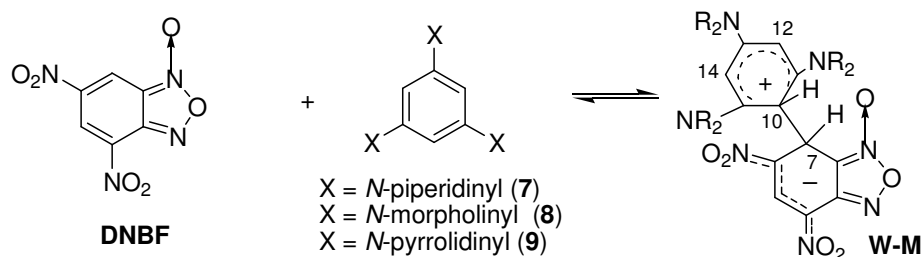

Scheme 31

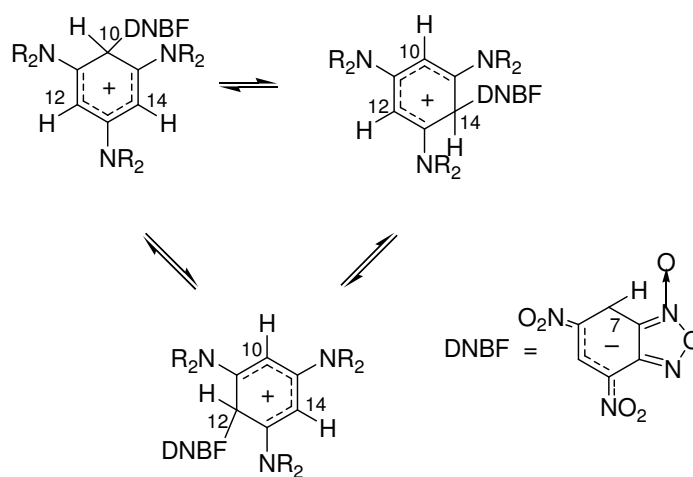

Scheme 32

A reaction similar to that of Scheme 31 is reported in Scheme 33. This reaction was carried out between 4,6-dinitro-tetrazolopyridine (**15**, **DNTP**), another carbon superelectrophile, and 1,3,5-tris(*N,N*-dialkylamino)benzenes, affording C–C coupling products (Scheme 33) which are, in this case too, “double σ complexes”, Wheland-like on the 1,3,5-tris(*N,N*-dialkylamino)benzene moiety, and Meisenheimer-like on the 4,6-dinitro-tetrazolopyridine moiety.

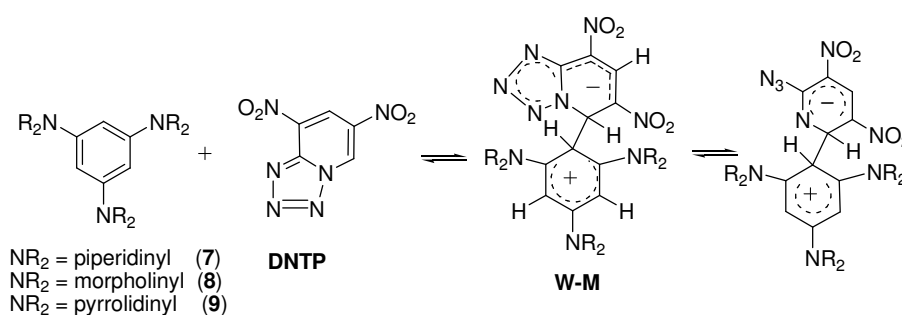

Scheme 33

These complexes are moderately stable at low temperature and they were characterized by NMR spectroscopy methods.⁴¹ The reaction of Scheme 33 was performed at $-70\text{ }^{\circ}\text{C}$ in CD_2Cl_2 directly in the NMR probe, by using equimolar amount of starting reagents. The azide form of **W-M** was not observed.

These reactions allow us to draw some interesting conclusions which are summarized as follows.

-Both exchanges of nucleophilic (Scheme 34) part and of the electrophilic part (Scheme 35) of the **W-M** complexes are a clear indication that this reaction is a reversible equilibrium.

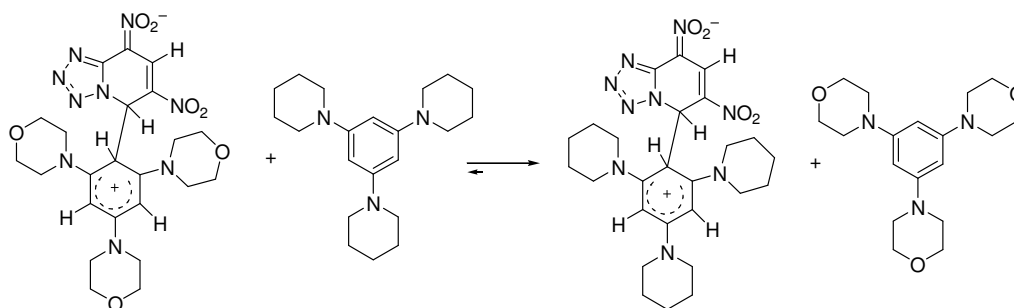

Scheme 34. Exchange of the nucleophilic partner.

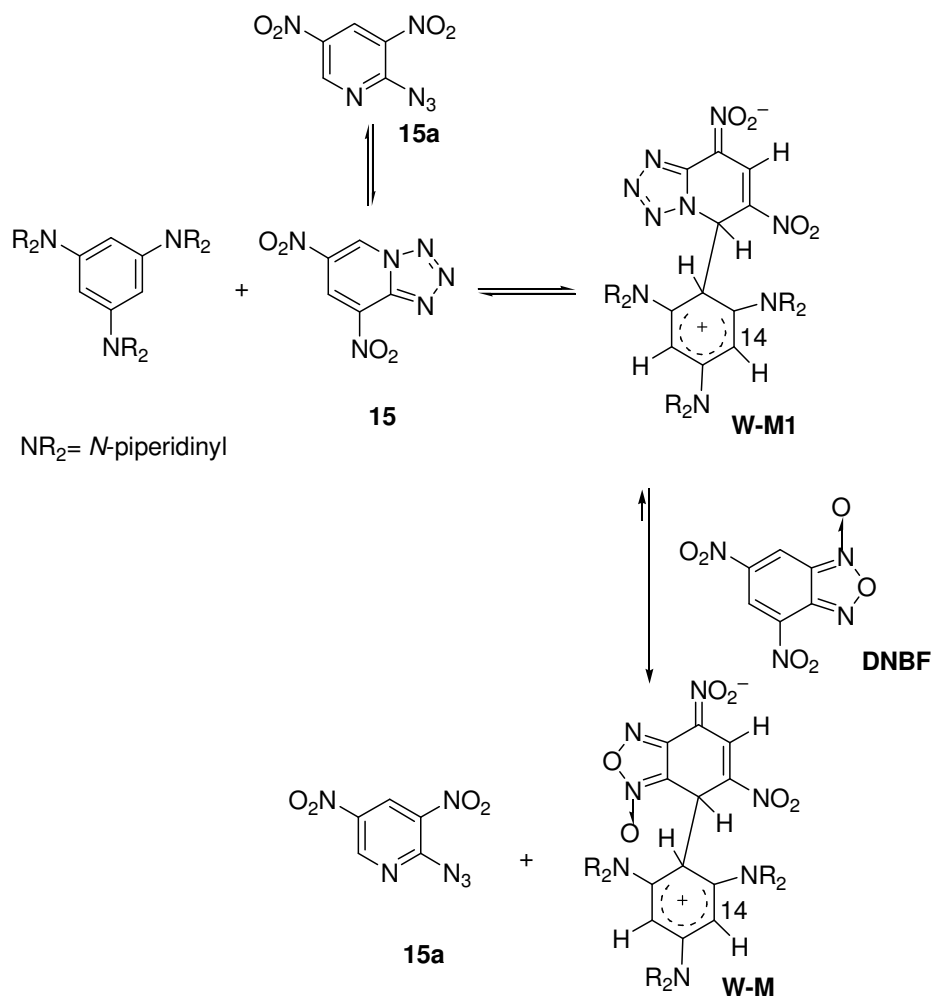

Scheme 35. Exchange of the electrophilic partner.

-In agreement to the reversibility of the **W-M** formation, the dynamic behaviour of complexes indicates the shift of the electrophilic moiety from a carbon to another (as an 1-3 shift, see Scheme 32).

-Probably, this shift occurs *via* a π complex which may be (owing the experimental conditions and the nature of involved reagents) a simple donor/acceptor complex.

-Finally, but this is not a marginal point, formation of such a **W-M** complexes reduces the importance of taxonomic classification of reactions (is the present reaction in the field of the electrophilic aromatic substitution, or in the field of the nucleophilic aromatic substitution reactions?) which, obviously, is a conventional classification. When there is a nucleophilic reagent, there is also an electrophilic reagent and the parameters involved in the reaction pathway are roughly the same.

The reaction of **DNBF** with a series of 2-aminothiazoles (see Scheme 36) affording thermodynamically stable C-bonded σ -adducts have been investigated^{42,43} in acetonitrile (and in DMSO-water mixtures). A most significant finding has emerged in recording NMR spectra immediately after mixing of equimolar amounts of **DNBF** and of the non-substituted 2-aminothiazole in Me₂SO-d₆: namely, the formation of the σ -anionic complex is preceded by that of a short-lived intermediate species. Based on the ¹H NMR parameters characterizing this intermediate, as well as the dependence of its lifetime on the experimental conditions (excess of **DNBF** over 2-aminothiazole increases the lifetime of this intermediate while excess of base (2-aminothiazole) accelerates its conversion into **ZW** of Scheme 36), it has been convincingly demonstrated that the structure of preceding intermediate combines the presence of a positively charged Wheland complex moiety (regarding the thiazole ring) with that of a negatively charged Meisenheimer complex moiety (regarding the benzofuroxan system). This intermediate is a **W-M** complex.

Among the key features supporting the intermediacy of **W-M** along the reaction coordinate leading to **ZW** is the fact that the reactions of **DNBF** with 2-aminothiazole in the presence of an alcohol (MeOH, EtOH, *n*PrOH) produce new adducts arising from the addition of an alcohol molecule to the thiazole moiety of **W-M**. Reflecting the presence of three chiral centres, these species are formed as a mixture of several diastereomers which could be characterized in their racemic forms in ethanol.

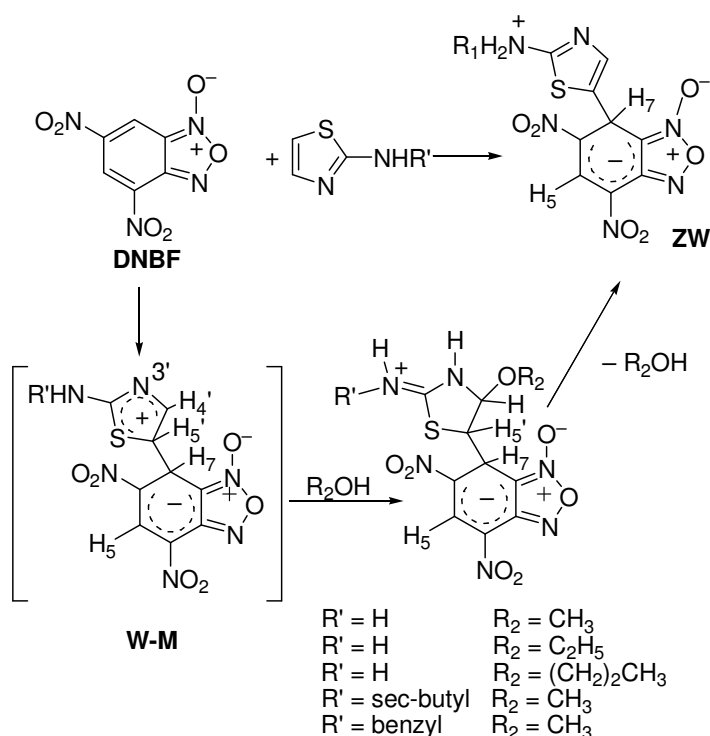

Scheme 36

These findings generalize the previous report on the formation of Wheland-Meisenheimer carbon-carbon complexes in carbocyclic series.

Recent searches on the reaction of 2,4-diaminothiazole derivative **12** with **DNBF** or **DNTP** allowed us to separate stable **W-M** complexes⁴⁴ whose structure have been investigated by X-ray diffraction.

4. Conclusions

On the basis of our searches, we are able to state that the two main ionic reactions on aromatic series (nucleophilic and electrophilic substitution) are less different than that usually proposed in the textbooks devoted to students where they belong to different chapters. This similarity covers, obviously, the carbocyclic series, but more interesting results are obtained when heterocyclic moieties are reacting, because they are more versatile and flexible partners able to emphasize particular phenomena difficult to observe in carbocyclic analogues. Actually, one can affirm that the ionic reactions of organic chemistry follow a common segment of pathway.¹⁰ In particular, aromatic nucleophilic and electrophilic substitution reactions may be instances of the simple scheme:

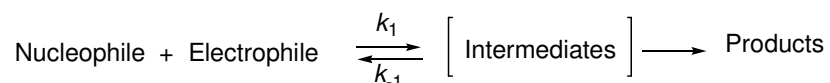

when 'intermediates' indicates a series of complexes, covalent (Wheland and Meisenheimer complexes) and non-covalent (donor-acceptor complexes, charge-transfer complexes, etc.).

The steps of obtainment of products may be a reversible step depending on experimental conditions which are also important in observing (or not) the series of complexes.

In this way, the presentation of organic chemistry knowledge to students too may be strongly simplified with the consequence of a more comprehensible and pleasant part of science often considered difficult and unpleasant.

References

1. Foster, R. *Organic Charge-Transfer Complexes*; Academic Press: New York, 1969.
2. Vogtle, F. *Supramolecular Chemistry*; Wiley: Chichester, 1991.
3. Reichardt, C. *Solvents and Solvent Effects in Organic Chemistry*; 3rd Ed.; Wiley-VCH: Weinheim, 2003.
4. Riddick, J. A.; Bunger, W. B. *Organic Solvents*; Weissberger, A., Ed.; Wiley Interscience: New York, 1970.
5. Kochi, J. K. *Acc. Chem. Res.* **1992**, *25*, 39.
6. Foster, R. *Organic Charge-Transfer Complexes*; Academic Press: New York, 1969.
7. Lippert, J. L. In *Molecular Complexes*; Foster R., Ed; Elek: London, 1973.
8. Schmid, G. H. In *The Chemistry of Functional Groups, Supplement A2: The Chemistry of Double-bonded Functional Groups*; Patai, S., Ed.; Wiley: Chichester, 1989, Chapt. 11.
9. (a) Ruasse, M. F. *Adv. Phys. Org. Chem.* **1993**, *28*, 207. (b) Bellucci, G.; Chiappe, C.; Bianchini, R.; Lenoir, D.; Herges, R. *J. Am. Chem. Soc.* **1995**, *117*, 12001. (c) Brown, R. S. *Acc. Chem. Res.* **1997**, *30*, 131. (d) Lenoir, D. *Angew. Chem. Int. Ed.* **2003**, *42*, 854.
10. Forlani, L. In *The Chemistry of Functional Groups, Supplement A3: The Chemistry of Double-bonded Functional Groups*; Patai, S., Ed.; Wiley: Chichester, 1997, Chapt. 8.
11. Bellucci, G.; Bianchini, R.; Chiappe, C.; Ambrosetti, R.; Catalano, D.; Bennet, A. J.; Slebocka-Tilk, H.; Aarts, G. H.; Brown, R. S. *J. Org. Chem.* **1993**, *58*, 3401.
12. Benesi, H. G.; Hildebrand, J. H. *J. Am. Chem. Soc.* **1949**, *71*, 2703.

13. Bernasconi, C. F. *Mechanism and Reactivity in Aromatic Nucleophilic Substitution Reactions*, In *MTP Internat. Rev. Sci. Org. Chem. Ser 1*; Butterworth: London, 1973, Vol. 3.
14. Bunnett, J. F. In *Investigation Rates and Mechanism of Reactions, Part I*; Hammes, G. G., Ed.; Wiley Interscience: New York, 1974, Chapt. 8.
15. Bunnett, J. F.; Randall, J. J. *J. Am. Chem. Soc.* **1958**, *80*, 6020.
16. Forlani, L.; Bosi, M. *J. Phys. Org. Chem.* **1992**, *5*, 429.
17. Chapman, N. B.; Parker, R. E. *J. Chem. Soc.* **1951**, 3301.
18. Forlani, L. *Gazz. Chim. Ital.* **1982**, *112*, 205.
19. Forlani, L. In *The Chemistry of Functional Groups, Supplement F2, Part 1: The Chemistry of Amino, Nitroso, Nitro and Related Groups*; Patai, S., Ed.; John Wiley and Sons: New York, 1996, Chapt. 10.
20. Forlani, L. *J. Chem. Soc., Perkin Trans. 2* **1993**, 1525.
21. (a) Forlani, L. *J. Phys. Org. Chem.* **1999**, *12*, 417. (b) Forlani, L.; Sintoni, M.; Todesco, P. E. *J. Chem. Res. (S)* **1986**, 344.
22. (a) Collina, G.; Forlani, L. *J. Phys. Org. Chem.* **1988**, *1*, 351. (b) Forlani, L.; Cimarelli, C. *J. Phys. Org. Chem.* **1989**, *2*, 653. (c) Boga, C.; Forlani, L. *J. Chem. Soc. Perkin Trans. 2*, **1998**, 2155.
23. Bayda, M.; Mayr, H. *Chem. Commun.* **2008**, 1792.
24. Forlani, L.; Boga, C.; Forconi, M. *J. Chem. Soc., Perkin Trans. 2* **1993**, 1455.
25. (a) Banjoko, O.; Ezeani, C.; *J. Chem. Soc. Perkin Trans. 2*, **1982**, 1357-1360. (b) Nudelman, N. S.; Palleros, D. *J. Org. Chem.* **1983**, *48*, 1607. (c) Banjoko, O.; Ezeani, C.; *J. Chem. Soc. Perkin Trans. 2*, **1986**, 531. (d) Hayami, J.; Otani, S.; Yamaguchi, F.; Nishikawa, Y. *Chem. Lett.* **1987**, 739.
26. Effenberger, F. *Acc. Chem. Res.* **1989**, *22*, 27.
27. (a) Cmoch, P.; Wiench, J. W.; Stefaniak, L.; Webb, G. A. *J. Mol. Struct.* **1999**, *510*, 165. (b) Pacionok, V. J.; Avramenko, L. F.; Grigorienko, T. F.; Skopienko, W. N. *Usp. Khim.* **1975**, *44*, 1028. (c) Könnecke, A.; Kleinpeter, E.; Lippmann, E. *Org. Magn. Reson.* **1979**, *12*, 385. (d) Hull, W. E.; Künstlinger, M.; Breitmaier, E. *Angew. Chem.* **1980**, *92*, 957. (e) Cmoch, P.; Stefaniak, L.; Webb, G. A. *Magn. Reson. Chem.* **1997**, *35*, 237.
28. (a) Rathore, R.; Hecht, J.; Kochi, J. K. *J. Am. Chem. Soc.* **1998**, *120*, 13278. (b) Hubig, S. M.; Kochi, J. K. *J. Am. Chem. Soc.* **2000**, *122*, 8279. (c) Koptyung, V. A. *Topics Curr. Chem.*; Boshke, F. L., Ed., Springer Verlag: Berlin, 1984, Vol. 122, p. 1. (d) Norris, J. F.; Ingraham, J. N. *J. Am. Chem. Soc.* **1940**, *62*, 1298. (e) Olah, G. A.; Kuhn, S.; Pavlath, A. *Nature* **1956**, 693. (f) MacLean, C.; Van der Waals, J. H.; Mackor, E. L. *Mol. Phys.* **1958**, *1*, 247. (g) Doering, W. v. E.; Saunders, M.; Boyton, H. G.; Earhart, H. W.; Wadley, E. F.; Edwards, W. R.; Laber, G. *Tetrahedron* **1958**, *4*, 178. (h) Birchall, T.; Gillespie, R. J. *Can. J. Chem.* **1964**, *42*, 502. (i) Rathore, R.; Hecht, J.; Kochi, J. K. *J. Am. Chem. Soc.* **1998**, *120*, 13278. (j) Olah, G. A.; Lin, H. C.; Mo, Y. K. *J. Am. Chem. Soc.* **1972**, *94*, 3667. (k) Mamatyuk, V. I.; Rezvukhin, A. I.; Detsina, A. N.; Buraev, V. I.; Isaev, I. S.; Koptyug, V. A. *Zh. Org. Khim.* **1973**, *9*, 2429. (l) Borodkin, G. I.; Nagi, S. M.; Gatilov, Y. V.; Shakirov, M. M.; Rybalvo, T. V.; Shubin, V. G. *Zh. Org. Khim.* **1992**, *28*, 1806. (m) Baenzinger, N. C.; Nelson, A. D. *J. Am. Chem. Soc.* **1968**, *90*, 6602. (n) Reed, C. A.; Fackler, N. L. P.; Kim, K.-C.; Stasko, D.; Evans, D. R.; Boyd, P. D. W.; Rickard, C. E. F. *J. Am. Chem. Soc.* **1999**, *121*, 6314.
29. Rosokh, S. V.; Kochi, J. K. *J. Org. Chem.* **2002**, *67*, 1727.
30. Boga, C.; Del Vecchio, E.; Forlani, L. *Eur. J. Org. Chem.* **2004**, 1567.
31. Forlani, L.; Boga, C.; Del Vecchio, E.; Tocke Dite Ngobo, A.; Tozzi, S. *J. Phys. Org. Chem.* **2007**, *20*, 2001.
32. Boga, C.; Del Vecchio, E.; Forlani, L.; Tozzi, S. *J. Org. Chem.* **2007**, *72*, 8741.
33. Strauss, M. J. *Chem. Rev.* **1970**, *70*, 667.
34. Terrier, F. *Chem. Rev.* **1982**, *82*, 78. (b) Buncel, E.; Dust, J. M.; Terrier, F. *Chem. Rev.* **1995**, *95*, 2261.
35. Artamkina, G. A.; Egorov, M. P.; Beletskaya, I. P. *Chem. Rev.* **1982**, *82*, 427.
36. Terrier, F. *Nucleophilic Aromatic Displacement*; VCH: New York, 1991.
37. Forlani, L.; Todesco, P. E. *J. Chem. Research, (S)* **1992**, 44.
38. Forlani, L.; Lugli, A. *Gazz. Chim. Ital.* **1993**, *23*, 677.
39. Forlani, L.; Ferrara, A.; Lugli, A.; Todesco, P. E. *J. Chem. Soc., Perkin Trans. 2* **1994**, 1703.
40. Boga, C.; Del Vecchio, E.; Forlani, L.; Mazzanti, A.; Todesco, P. E. *Angew. Chem. Int. Ed.* **2005**, *44*, 3285.

41. Boga, C.; Del Vecchio, E.; Forlani, L.; Mazzanti, A.; Menchen Lario, C.; Todesco, P. E.; Tozzi, S. *J. Org. Chem.* **2009**, *74*, 5568.
42. Forlani, L.; Tocke, A.; Del Vecchio, E.; Lakhdar, S.; Goumont, R.; Terrier, F. *J. Org. Chem.* **2006**, *71*, 5527.
43. Boga, C.; Del Vecchio, E.; Forlani, L.; Goumont, R.; Terrier, F.; Tozzi, S. *Chem. Eur. J.* **2007**, *13*, 9600.
44. Forlani, L.; Boga, C.; Mazzanti, A.; Zanna, N., *Eur. J. Org. Chem.* **2012**, 1123.

DOMINO REACTIONS IN THE CONSTRUCTION OF NITROGEN HETEROCYCLES: AN ACCOUNT

Subbu Perumal^a and J. Carlos Menéndez^b

^a*Department of Organic Chemistry, School of Chemistry, Madurai Kamaraj University, Madurai 625021, India (e-mail: subbu.perum@gmail.com)*

^b*Departamento de Química Orgánica y Farmacéutica, Facultad de Farmacia, Universidad Complutense, E-28040 Madrid, Spain (e-mail: josecm@farm.ucm.es)*

Abstract. *This chapter describes the synthesis of structurally diverse nitrogen heterocycles comprising one or more ring systems employing domino reaction sequences, drawn mostly from the research experience of the authors' research groups.*

Contents

1. Introduction
2. Mannich-initiated domino reactions
3. Enamine-initiated domino reactions
4. Imine-initiated domino reactions
5. Knoevenagel-initiated domino reactions
6. Michael-initiated domino reactions
7. Domino sequences including cycloaddition steps
8. Conclusion

Acknowledgments

References

1. Introduction

Heterocycles play a vital role in any developed society. To give just one example of their importance, they constitute about 60% of all drug substances. Nitrogen compounds are the single most important class of heterocycles and are essential as drugs, agrochemicals and new materials.¹ The purpose of this article is to highlight the use of domino reactions for the synthesis of nitrogen heterocycles, with particular emphasis on the literature of the last ten years. Because of the huge size of this field, we will mostly focus our discussion on examples chosen from the work performed in our laboratories, first independently and more recently in collaborative research, although in some places we have also given additional relevant examples from the work of other groups when we felt this would contribute to the clarity of the manuscript. While we concentrate on the synthesis of nitrogen heterocycles, we have not avoided mentioning some cases where the reactions took an unexpected course, leading to carbocycles. We hope this will help readers to appreciate how investigations in one research area can land them into other interesting results. In order to facilitate mechanistic understanding of the complex reaction sequences that take place in most of the chosen examples, this chapter has been organized according to the type of reaction that initiates the domino process.

Domino reactions are one-pot processes involving two or more reactions occurring in sequence from one or more starting compounds without changing reaction conditions and in such a way that a functional

group generated in one step participates in subsequent reactions.² When more than two reactants are involved in a domino process, the latter are referred to as multicomponent domino reactions. As several reactions occur in one pot, this type of protocol results in a rapid access to complex molecules, thus affording convergent, efficient, expedient and economic methods. By their very nature, domino processes avoid the isolation and purification of the products of intermediate steps, maximizing the yield of the final product and making them fast and user-friendly. As another consequence, minimal amounts of waste from solvents and chromatographic stationary phases are generated, rendering domino protocols eco-friendly.³ All these advantages render domino reactions very useful in combinatorial synthesis and drug development programs.⁴ The use of domino processes as key steps in target-oriented syntheses is also receiving increased attention from the synthetic community.⁵ Nature employs domino reactions in the biosynthesis of several types of complex structures.

Domino reactions are often discovered in serendipitous ways, although there is much current interest in their invention, as opposed to their discovery. A key consideration in this connection is that, as the individual steps occur in one pot, at least some of them need to have comparable activation energies, enabling them to occur in the same set of reaction conditions. In many cases, the driving force of a domino process is an irreversible step with a very low activation energy (*e.g.*, an aromatization reaction).

2. Mannich-initiated domino reactions

We will start our discussion by mentioning a Mannich-initiated three-component domino synthesis of pyrrolidine derivatives, which was achieved by treatment of ethyl 4-chloroacetoacetate with aromatic aldehydes and ammonium acetate in 1:2:1 molar ratio, using ethanol as solvent. This reaction presumably proceeds *via* a domino sequence comprising Mannich and S_N2 individual reactions, followed by acetylation and aldol addition, affording highly functionalized pyrrolidines diastereoselectively. The *trans*-pyrrolidin-3-ones thus obtained were useful starting materials for further synthetic transformations and thus their acetylation, followed by aldol additions, diastereoselectively afforded highly functionalized pyrrolines bearing three stereogenic centres which, interestingly, showed different tautomeric structures in solution and in the solid state (Scheme 1). This can be probably ascribed to the existence of several possibilities of intramolecular hydrogen bonding, which are probably different in both cases.⁶ It is pertinent to other sections of this chapter to mention here that L-proline-catalyzed Mannich reaction of ketones, aromatic aldehydes and ammonia furnishes 3-substituted 2,6-diarylpiperidin-4-ones in enhanced yields (up to five times) compared to the reaction involving ketone, aldehyde and ammonium acetate. The catalytic efficiency of proline is ascribed to the involvement of an enamine intermediate that could result from the reaction of ketones with proline and the absence of the formation of bicyclic side product in this reaction.

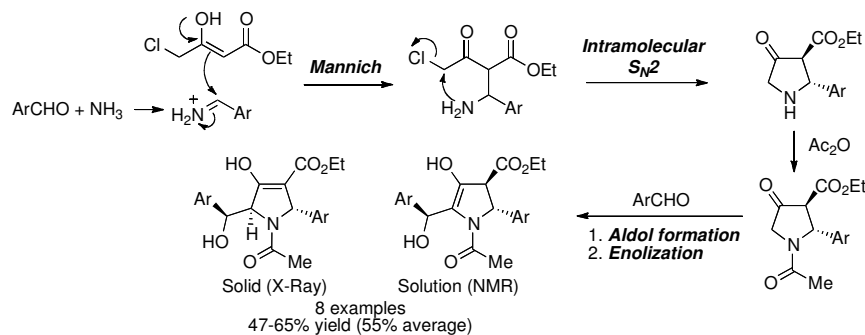

Scheme 1

Double Mannich reactions have provided a fruitful strategy for the access to six-membered nitrogen heterocyclic rings. Sir Robert Robinson's pioneering synthesis of tropinone takes place *via* a multi-component domino reaction that involves inter- and intramolecular Mannich steps (Scheme 2)⁷ and it is the first example of a biomimetic synthesis, *i.e.*, a synthetic route purposefully designed to imitate a biosynthetic pathway.

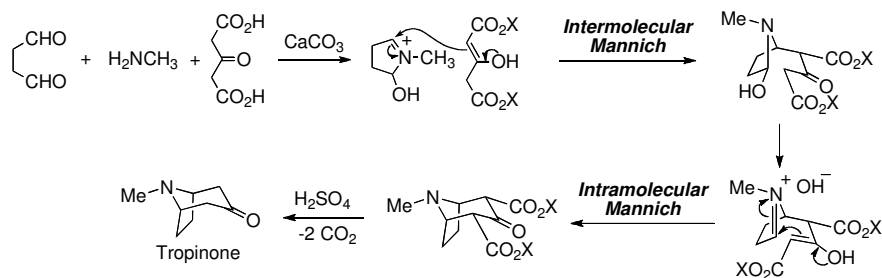

Scheme 2

Noller developed additional early work in the field of nitrogen heterocycles using double Mannich chemistry. He discovered that the reaction of acetone and its derivatives with aromatic aldehydes and ammonium acetate in a molar ratio of 1:2:1 furnished 2,6-diarylpiperidin-4-ones. As shown in Scheme 3, this reaction occurs through an inter- and an intramolecular Mannich reaction sequence and takes place with complete chemoselectivity. Furthermore, the reaction was fully diastereoselective and afforded exclusively the more stable compounds with a *cis* diequatorial arrangement for the two aryl substituents.

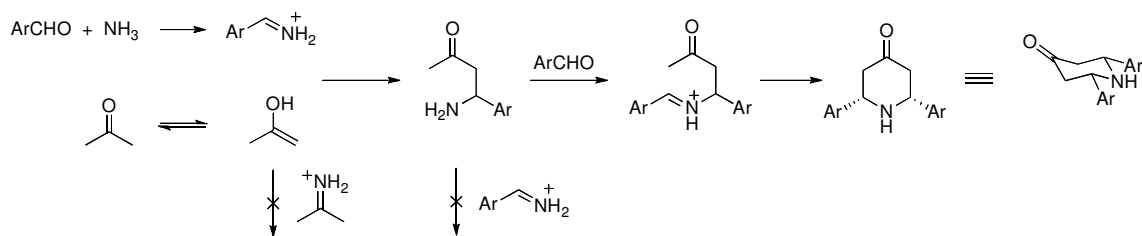

Scheme 3

Some synthetically useful variations of this reaction have been developed in recent years. In the simplest of them, β -ketosulfoxides were employed as the substrate. Their reaction with aromatic aldehydes and ammonium acetate in a 1:2:1 molar ratio proceeded by a Mannich-Mannich-elimination domino process, leading to the generation of an α,β -unsaturated carbonyl moiety in the final product (Scheme 4).⁸

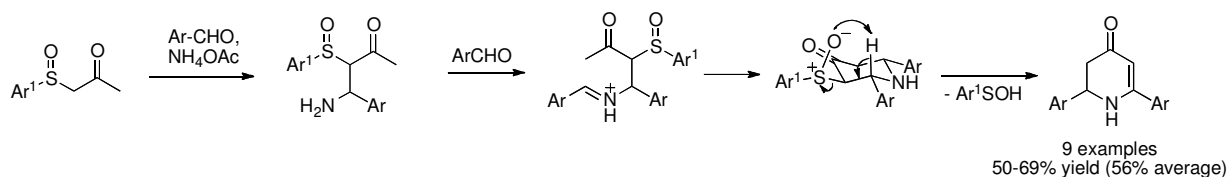

Scheme 4

A related pseudo four-component reaction of a β -keto thioether, namely ethyl 2-[(2-oxopropyl)sulfonyl] acetate, an aromatic aldehyde and ammonium acetate in a 1:2:2 molar ratio afforded pyrido [3,4-*b*][1,4]thiazin-2(3*H*)-ones as a mixture of two diastereomers **2** and **3**, presumably *via* a novel Mannich-Mannich-enamine formation-substitution domino sequence with compounds **1** as intermediates (Scheme 5).

The formation of the *trans*-compounds **3** may be explained if the configuration at the carbon bearing an aryl group adjacent to the enamide double bond is inverted *via* ring opening and closure. When *o*-substituted benzaldehydes were employed in this reaction, compounds **4** were obtained *via* air oxidation of **2**, along with the corresponding *trans*-compounds **3**.⁹

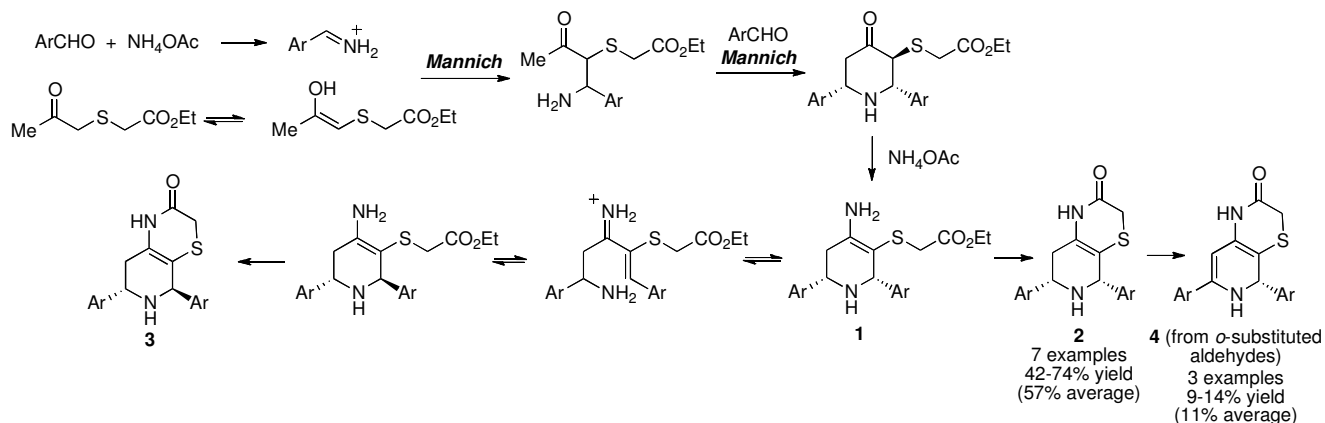

When the second Mannich reaction on the α' ketone side was prevented by using an acetophenone derivative as the starting material, the course of the domino process deviated towards the formation of perhydro-1,4-thiazines **5** *via* a Mannich-Mannich sequence.¹⁰ On the other hand, when the same reagents were mixed in the presence of proline, the second Mannich reaction did not occur and an intramolecular amidation took place instead, leading to *trans*-disubstituted thiomorpholinones **6** after formation of one C–C and two C–N bonds in a one-pot operation (Scheme 6).¹¹ Interestingly, compounds **6** thus obtained adopt a boat conformation, as shown by NMR and X-ray studies.

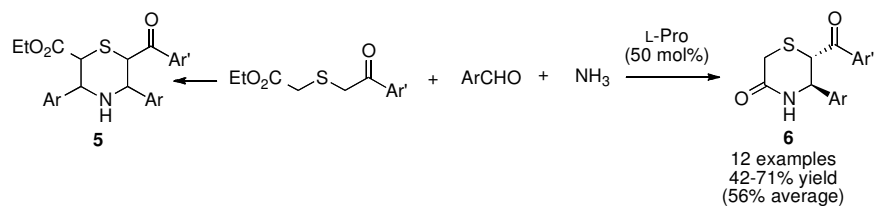

A plausible mechanism for the formation of thiomorpholinones **6** is depicted in Scheme 7. The starting material reacts with *L*-proline furnishing enamine **7**, which reacts with the iminium ion arising from the aromatic aldehyde to afford **8**. This approach occurs with the two aryl rings away from each other, *via* approaches **A** or **B**, affording the *trans*-thiomorpholinones in racemic form. The approach represented by **C** is presumably hampered by the steric interactions between the aryl rings, explaining the absence of the *cis*-diastereomers of **6**.

In a related transformation, another type of sulfides having two active methylene functions, namely bis(arylmethyl) sulfides, gave the expected 2,6-diaroyl-3,5-diaryltetrahydro-1,4-thiazines **9** upon treatment with aromatic aldehydes and ammonium acetate in 1:2:1 molar ratio, from a Mannich-Mannich sequence. In contrast, the same reactants, under solvent-free microwave irradiation conditions, afforded predominantly

thiazole derivatives **10** (Scheme 8).¹² The latter reaction presumably starts by a Knoevenagel condensation and will therefore be discussed in Section 5.

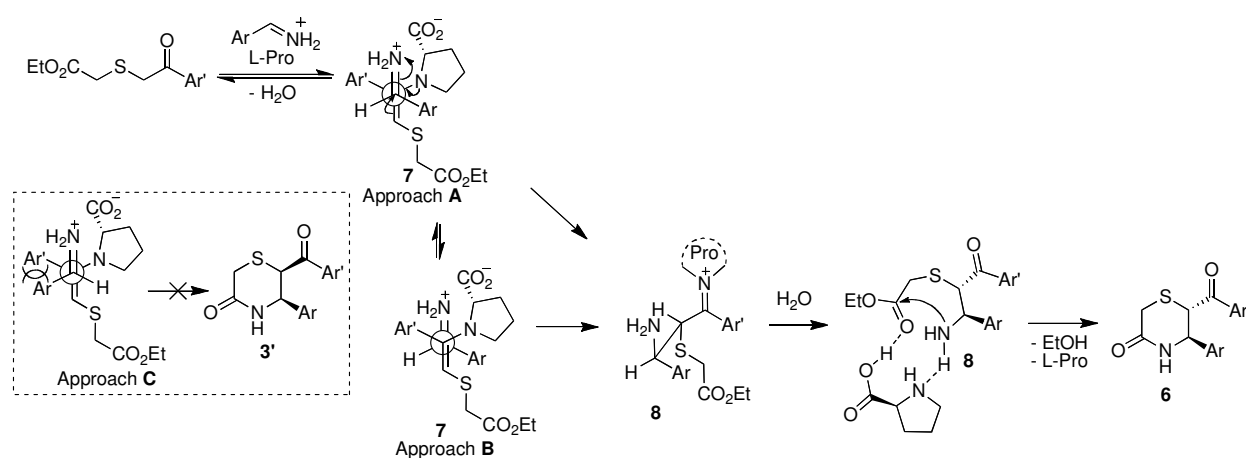

Scheme 7

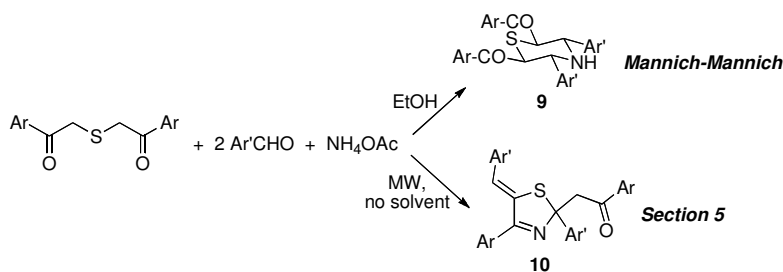

Scheme 8

3. Enamine-initiated domino reactions

Besides the proline-catalyzed Mannich reactions mentioned above, some novel chemistry initiated by the formation of an enamine intermediate and leading to syntheses of nitrogen heterocyclic systems has been developed in recent years. Thus, the investigation of the Robinson annulation of 1-substituted piperidin-4-ones with (*E*)-4-arylbut-3-en-2-ones in the presence of L-proline led to the discovery of interesting routes to fused bicyclic, tricyclic and bridged nitrogen heterocycles (Scheme 9). The product selectivity of these reactions hinges on the nature of the substituent linked to the piperidine nitrogen. In the reactions starting from alkyl or benzylpiperidines, the expected isoquinoline derivatives **11** from Robinson annulation were obtained, albeit with an additional chain derived from a second molecule of the enone, whilst the *N*-(α -phenylethyl) group led to fused tricyclic compounds **12**. Finally, *N*-arylpiperidines afforded the bridged bicyclic compounds **13**, derived from the 3-azabicyclo[3.3.1]nonan-9-one system.¹³

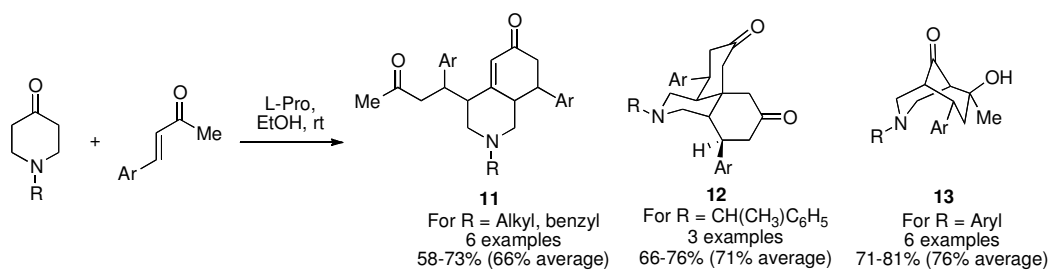

Scheme 9

The mechanism starts with the formation of the imine of proline with the starting piperidone, as the first step of its Michael addition to the enone. The adduct **14** thus generated may react again with proline in two alternative positions, namely at the piperidone carbonyl (leading to compounds **13**) or at the side chain carbonyl, affording the Robinson annulation product. This compound could not be isolated as such, as it underwent an additional proline-catalyzed vinylogous Michael reaction to give compound **11** via intermediate **15**. A final intramolecular Michael addition explains the formation of tricyclic compounds **12**.

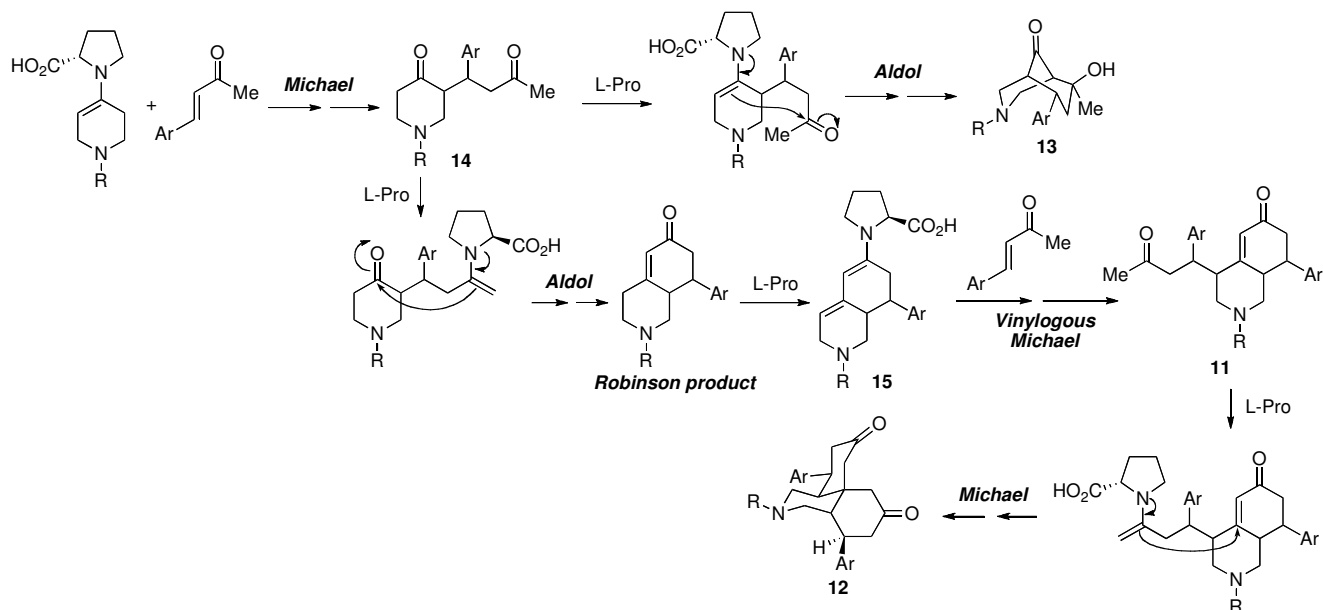

Scheme 10

One of the first domino multicomponent reactions to be described was the classical Hantzsch dihydropyridine synthesis. This is a pseudo four-component reaction that starts from two molecules of a β -dicarbonyl compound, an aldehyde and ammonia, and proceeds by formation of a β -enaminoester from ammonia and a first molecule of the β -dicarbonyl starting material, while a Knoevenagel reaction takes place between the aldehyde and the second molecule of the β -dicarbonyl compound. A Michael addition creates a C–C bond between both fragments and a final cyclocondensation with loss of a molecule of water completes the formation of the dihydropyridine (Scheme 11).

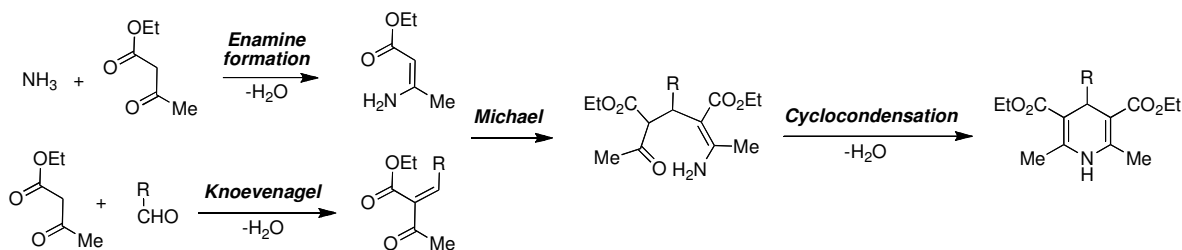

Scheme 11

Beyond the Hantzsch and related reactions, much work has been devoted in recent years to the development of domino reactions leading to heterocycles and having β -enaminones as intermediates and we will describe below some representative examples of this research. Our own involvement in this field started with the discovery of cerium(IV) ammonium nitrate as a very efficient catalyst for the reaction of amines and β -dicarbonyl compounds.¹⁴ As an application, we also studied the CAN-catalyzed Friedländer synthesis

of quinolines,¹⁵ which can be viewed as an enamine formation-intramolecular aldol domino process. Due to the existence of very little literature precedent for the catalysis of double Friedländer processes by Lewis acids, these transformations were also successfully explored; compound **16** is an example of the type of frameworks available through this methodology (Scheme 12).

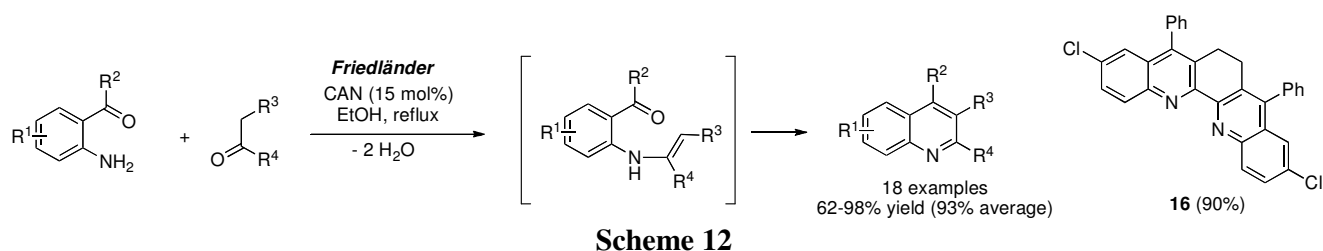

The CAN-promoted Friedländer reaction was also applied to the synthesis of luotonin A, an antitumor alkaloid isolated from *Peganum nigellastrum* acting as an inhibitor of topoisomerase I, that was prepared in 65% yield by Friedländer reaction in refluxing ethanol between *o*-aminobenzaldehyde and compound **17**. This result was a big improvement over previous attempts using basic catalysts, which had afforded luotonin A in only 30% yield from the same starting materials.¹⁶ Nevertheless, the desired transformation competed with a CAN-catalyzed pseudo four-component reaction affording compound **18** from three equivalents of *o*-aminobenzaldehyde and one of ethanol (Scheme 13). This side reaction was prevented by employing the Borsche modification of the Friedländer reaction, involving replacement of the aminobenzaldehyde by its *p*-tolylimine and, in this case, the yield of luotonin was 82%.

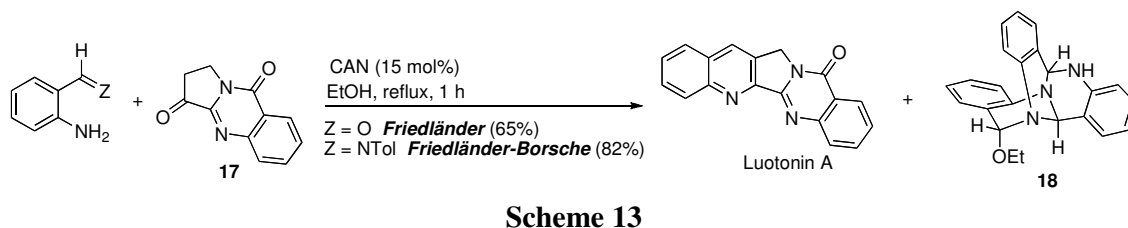

Among the available synthetic methodologies leading to indoles, the Nenitzescu reaction, *i.e.*, the reaction between 1,4-benzoquinones and β -enaminones to afford 5-hydroxyindoles,¹⁷ has remained relatively unexplored, despite its experimental simplicity and the pharmaceutical applications of some of the products derived from its use.

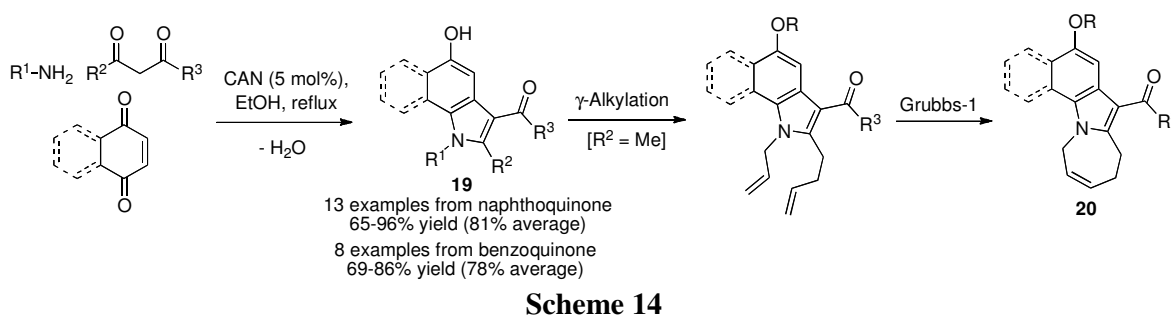

The main drawbacks of this methodology include the problems associated with the purification of the acid-sensitive enaminones and the poor yields normally observed for the final products. The use of CAN as a

catalyst overcame these problems by allowing the development of a general and efficient one-pot three-component domino version of the reaction. Furthermore, the synthetic utility of compounds **19** thus generated for the preparation of more complex heterocyclic frameworks was explored. For instance, they could be transformed into compounds **20** using a γ -allylation/ring closing metathesis protocol (Scheme 14).¹⁸

A mechanistic study revealed this transformation to proceed through a pathway that is slightly different to the two alternative ones commonly accepted for the Nenitzescu reaction in that it does not involve any redox step. In this mechanism, the enaminone formed by reaction between the starting amine and 1,3-dicarbonyl compound adds to the CAN-activated quinone to afford a Michael adduct which, under reflux conditions, undergoes a fast intramolecular nucleophilic cyclization, prompted by coordination of Ce(IV) to its carbonyl group and this is followed by elimination of a molecule of water to furnish the observed products **19** (Scheme 15). Thus, the Lewis acid has the three-fold mission of promoting the formation of enamines from 1,3-dicarbonyl compounds and primary amines and facilitating their subsequent Michael addition to quinones and, finally, the cyclocondensation that creates the indole ring.

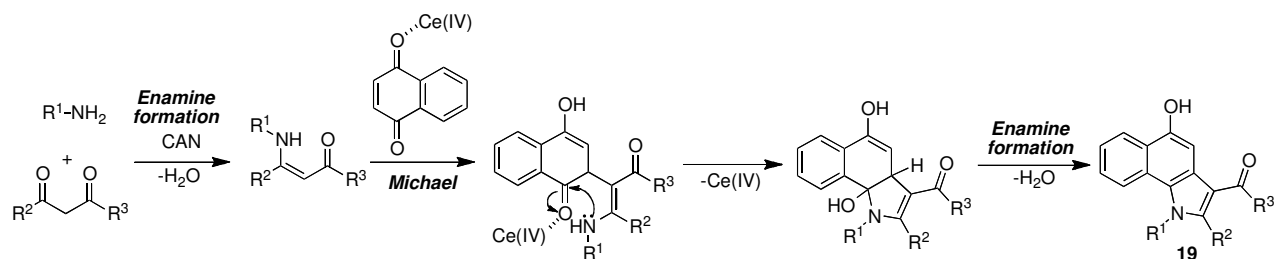

Scheme 15

Interestingly, the use of bromonaphthoquinone as the starting material changed the reaction mode to an enamine formation-Michael-oxidation-Michael domino sequence, leading to a method for the preparation of linear tricyclic systems (Scheme 16). Although the reaction was not general, as it only worked well for β -diketones, and yields never exceeded 70%, it has many advantages over Ullman-based literature methods allowing access to the same type of products.

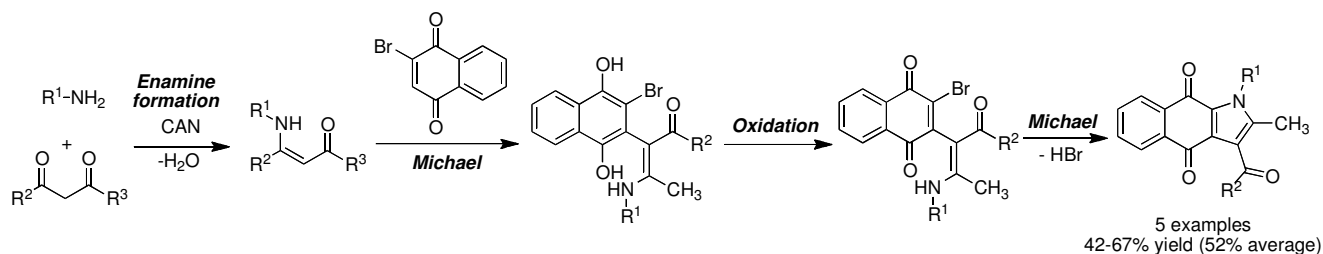

Scheme 16

The CAN-catalyzed four-component domino reaction between amines, β -dicarbonyl compounds, α,β -unsaturated aldehydes and ethanol afforded good to excellent yields of 2-ethoxy-1,2,3,4-tetrahydropyridines **20** (Scheme 17).¹⁹

The mechanism of this transformation is summarized in Scheme 18. The initial CAN-catalyzed reaction between the starting amines and β -keto(thio)esters gives the corresponding β -enaminones, whose Michael addition to the α,β -unsaturated aldehydes affords an imine. This intermediate tautomerizes to an enamine that undergoes a subsequent cyclization to give 2-hydroxytetrahydropyridines, which are finally

transformed into the observed products **20** by nucleophilic displacement of their hydroxy group by a molecule of ethanol.

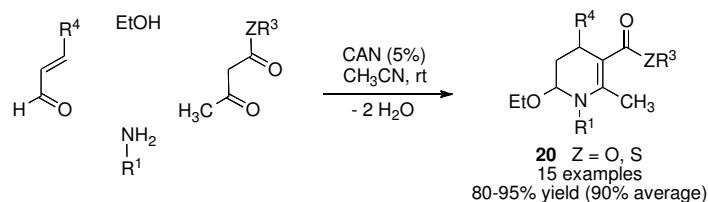

Scheme 17

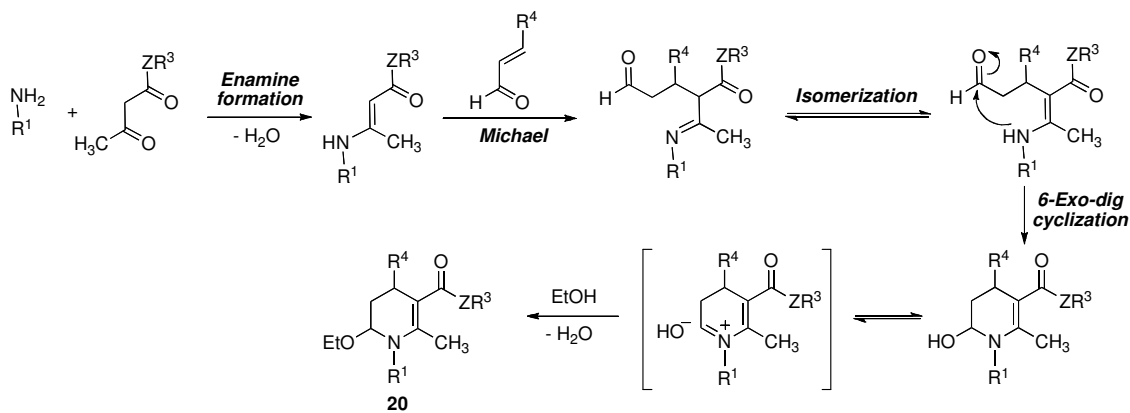

Scheme 18

The four-component tetrahydropyridine synthesis could be applied to efficiently generate structural diversity and complexity in few steps from very simple starting materials. For instance, the four-component reaction between allylamine, 2-hexyn-1-ol, acrolein and ethyl acetoacetate afforded compound **21**, which was transformed into the pyrido[2,1-*b*][1,3]oxazepine derivative **22** by ring-closing ene-yne metathesis catalyzed by the Grubbs first-generation catalyst, in an ethylene atmosphere. A Diels-Alder reaction of **22** with *N*-methylmaleimide provided the hitherto unknown polyheterocyclic framework of compound **23** as a single diastereomer, whose relative configuration was in agreement with the expected anomeric and *endo* effects (Scheme 19).²⁰

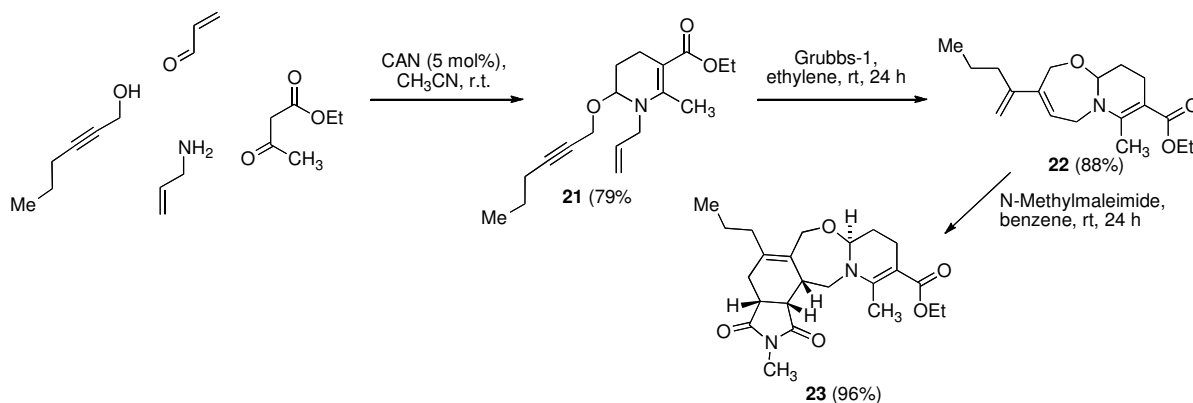

Scheme 19

A related application of the tetrahydropyridine synthesis to the generation of molecular diversity and complexity is summarized in Scheme 20. After extensive optimization work, it was discovered that neutral alumina is an excellent reagent for the elimination of a molecule of ethanol from the tetrahydropyridine

derivatives affording the corresponding 1,4-dihydropyridines,²¹ in a method that can be considered complementary to the Hantzsch reaction because it provides 5,6-unsubstituted compounds. The use of the electron-rich 5,6-bond of these materials as the dienophile component of Povarov reactions, as pioneered by Lavilla,²² was next examined and it was found that the use of indium trichloride as catalyst allowed the one-pot synthesis of dihydropyridines from the usual starting materials and their treatment with anilines and ethyl glyoxylate in the presence of ytterbium triflate gave the expected pyrido[3,2-*c*]quinolines.²³ Unfortunately, it was not possible to carry out the whole process as a one-pot sequence, as originally intended, because of incompatibility between the catalysts. For further comments on the Povarov reaction, see Section 4.

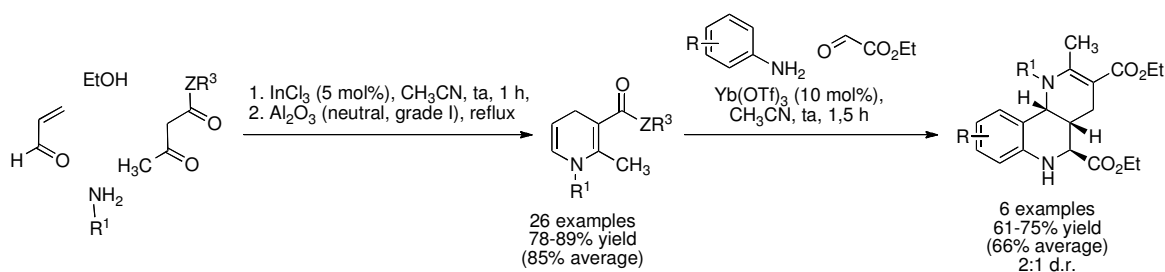

Scheme 20

The multicomponent tetrahydropyridine synthesis was also coupled with γ -allylation and ring-closing metathesis for the preparation of homoquinolizine derivatives, without the need to purify any intermediate (Scheme 21).²³

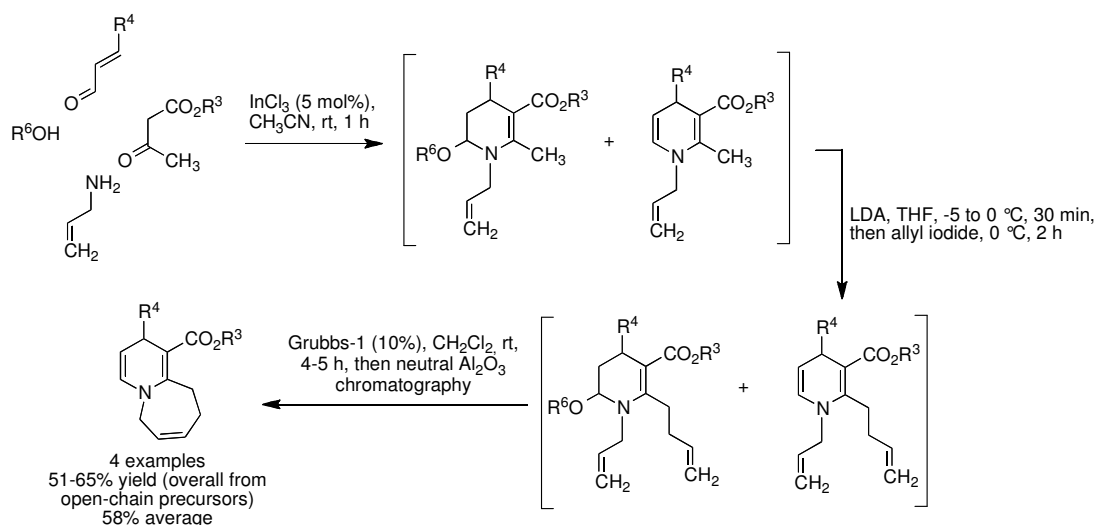

Scheme 21

The multicomponent domino reaction was also employed as the key step in the total synthesis of pumiliotoxin C, a bioactive alkaloid isolated from frogs of the *Dendrobatidae* family. This required adapting the four-component reaction to the synthesis of octahydroquinolines by employing a cyclic β -dicarbonyl substrate; this modification turned out to need a change of catalyst and extensive experimentation revealed indium triflate to be the best choice. Incorporation of the three-carbon chain at C-2 was achieved by allylation with allyltrimethylsilane in the presence of boron trifluoride, a transformation that has some interest because of the absence of literature precedent for nucleophilic additions onto polyhydroquinoline systems mediated by vinylogous acyl cation intermediates. Compound **25** obtained from this reaction was

N-debenzylated to **26** by hydrogenolysis, with concomitant reduction of the allyl group, and this intermediate was transformed into **27** in a second hydrogenation step, with complete diastereoselectivity that can be explained by assuming that the major conformer for the ring system is the one with an equatorial arrangement for the propyl substituent, in which the top face is more accessible to the hydrogenation catalyst. The *N*-BOC derivative of compound **27** was transformed into **28** by oxidation with the Dess-Martin reagent and this was followed by a Petasis methylenation to **29** and diastereoselective hydrogenation of the exocyclic double bond and a final *N*-deprotection. An attempt was made to transform **27** directly into pumiliotoxin C *via* a methylenation-reduction sequence, avoiding the *N*-protection step, but in this case the final hydrogenation lacked diastereoselectivity. Presumably, the presence of the *N*-BOC substituent led to a diastereoselective hydrogenation by forcing the system to exist predominantly in a conformation where the carbamate substituent blocked the top face of the molecule (Scheme 22).²⁴

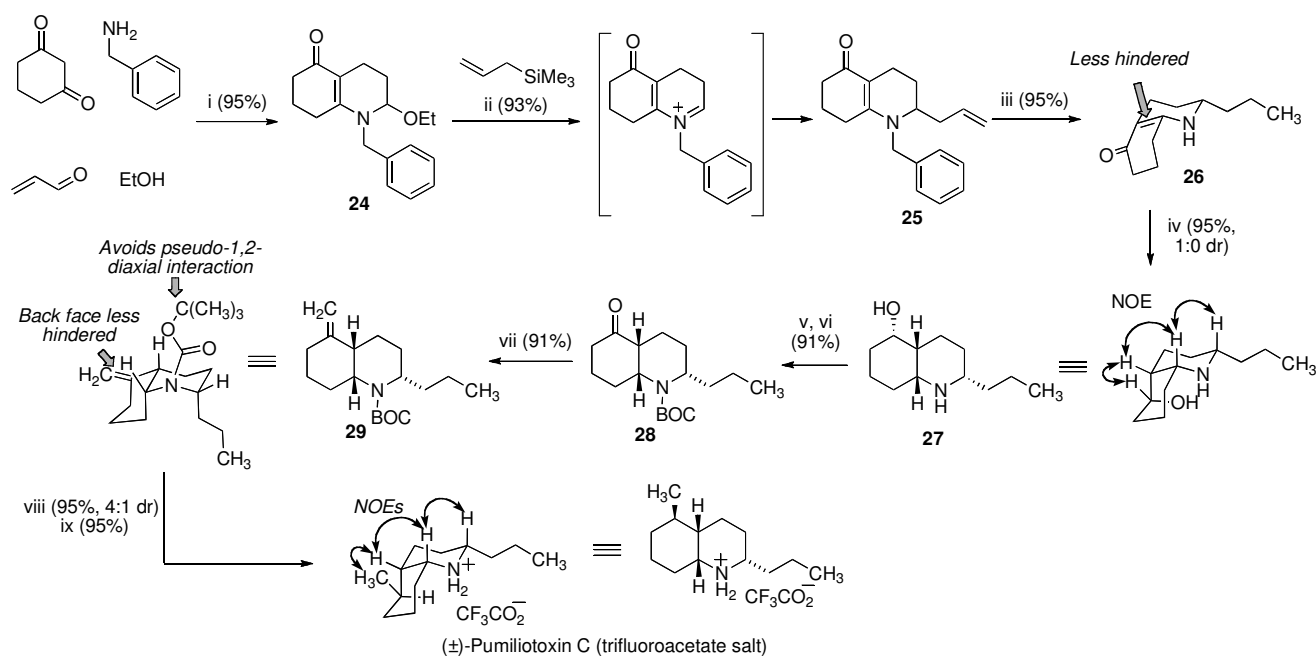

Reagents and conditions i. $\text{In}(\text{OTf})_3$ (5 mol%), DCM, rt, 5 h. ii. $\text{BF}_3 \cdot \text{Et}_2\text{O}$, DCM, rt, 4 h. iii. H_2 (60 psi), Pd-C (10%), AcOH, 50 °C, 15 h. iv. H_2 (90 atm), Pt-C (5%), 50 °C, 24 h. v. BOC_2O , K_2CO_3 , CH_3CN , reflux, 24 h. vi. Dess-Martin, DCM, rt, 4 h. vii. Cp_2TiMe_2 , toluene, reflux, 20 h. viii. H_2 (1 atm), PtO_2 , MeOH, rt, 1 h. ix. $\text{CF}_3\text{CO}_2\text{H}$, DCM, rt, 4 h.

Scheme 22

Interestingly, the course of the four-component domino reaction was very sensitive to the nature of the Michael acceptor. As shown in Scheme 23, replacement of acrolein by chalcones afforded cyclohexene derivatives **34** instead of the expected tetrahydropyridines **32**. This behaviour suggested that in this case the last step of the domino sequence, namely replacement of the hydroxyl by an alkoxy, was not possible, perhaps for steric reasons and instead the system evolved by generation of the enamine alternative to **31**, namely intermediate **33**. Unfortunately, other types of α,β -unsaturated ketones gave complex mixtures.

Compounds **34** thus obtained were regarded as interesting precursors to cyclic β -amino acid derivatives, which are biologically significant compounds. For this reason, the reduction of the double bond in **34** was examined and found to proceed in a completely diastereoselective fashion by treatment with sodium triacetoxyborohydride, generated *in situ* by exposure of sodium borohydride to acetic acid, affording compounds **35** (Scheme 23).

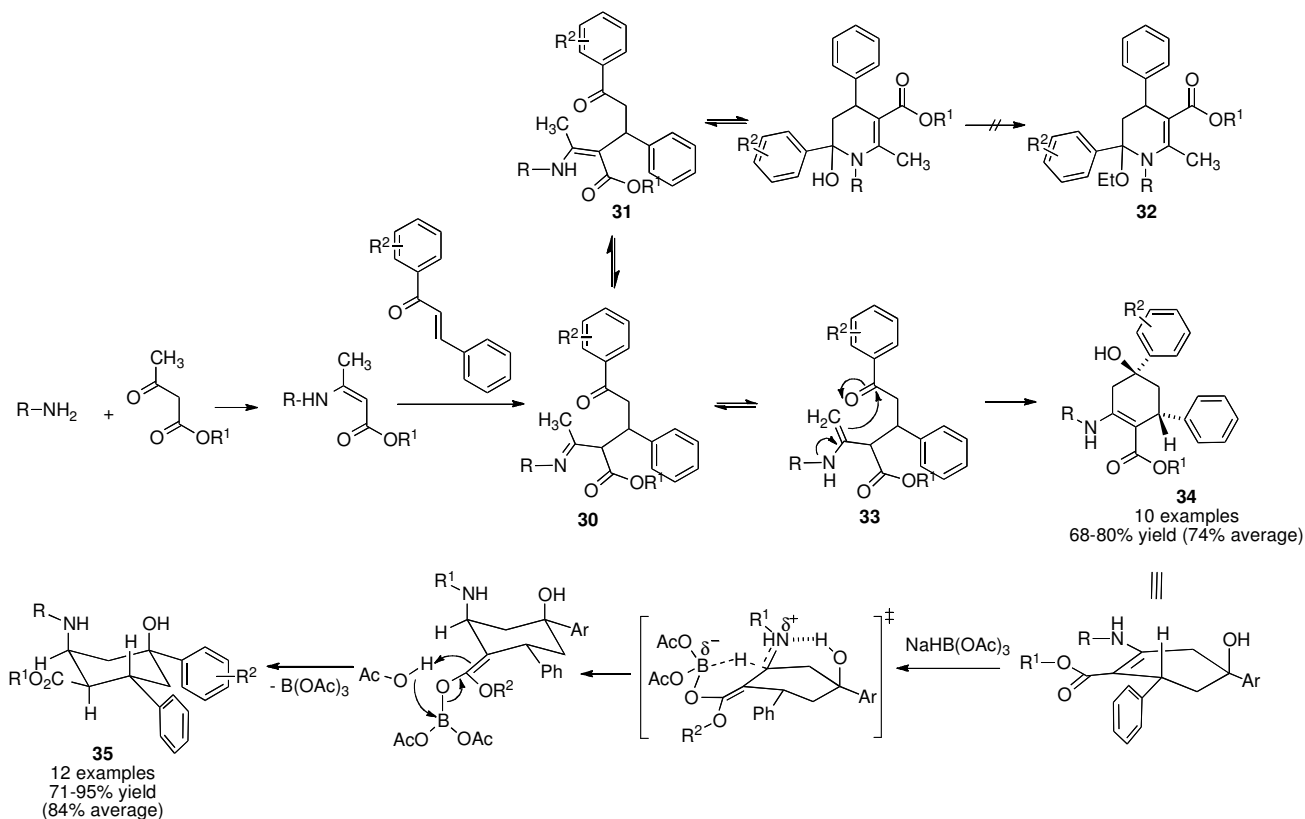

Scheme 23

4. Imine-initiated domino reactions

A three-component domino reaction similar to the one summarized in Scheme 17 but starting from anilines and cinnamaldehyde derivatives turned out to proceed by a rather different mechanism, involving in this case the initial formation of an imine rather than an enamine, probably because of the generation of a highly extended conjugated system. A Michael addition of the starting β -dicarbonyl compound followed by a cyclocondensation step completed the formation of a dihydropyridine system (Scheme 24).²⁵ This protocol is complementary to the one previously described in Scheme 20, which did not allow aryl substituents at the positions 1 and 4. A number of groups have subsequently developed organocatalytic asymmetric versions of this reaction.²⁶⁻²⁸

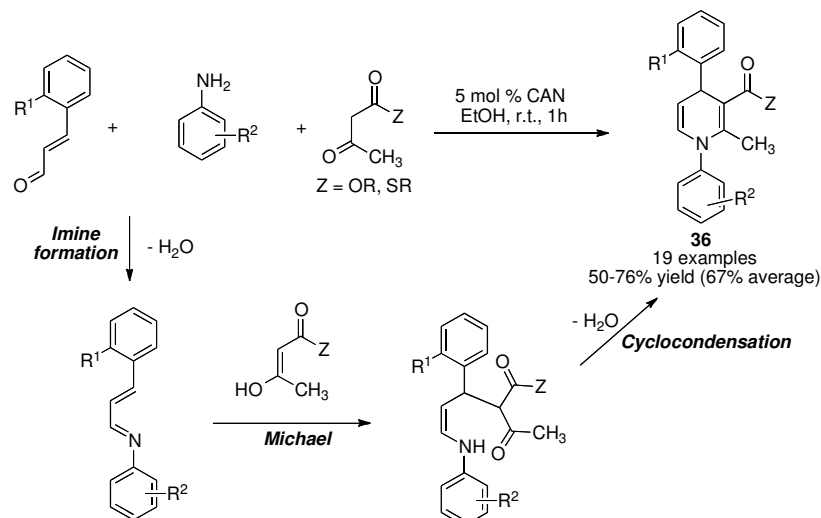

Scheme 24

The Povarov reaction was initially described as an imino Diels-Alder reaction between aromatic imines and electron-rich alkenes and was subsequently developed as a three-component reaction where the starting imines were generated *in situ*.²⁹ It can be considered as one of the most direct methods allowing the synthesis of 1,2,3,4-tetrahydroquinolines,³⁰ which has prompted its study in the presence of a variety of catalysts in recent years. As an example, the results obtained with CAN are summarized in Scheme 25. This catalyst gave the typical response with cyclic enol ethers, *i.e.*, almost equimolecular amounts of the *exo* and *endo* diastereomers of the fused tetrahydroquinolines **37**, but it had the advantage over others of being sufficiently active to allow the reaction with open-chain alkyl vinyl ethers to be studied. The latter reaction gave exclusively the *trans* products **38**.³¹

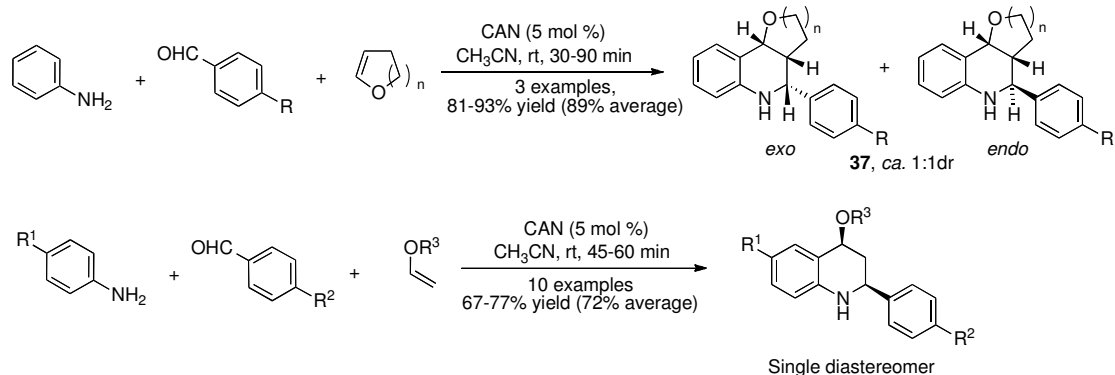

In spite of being normally classified as an imino Diels-Alder reaction, there is much evidence pointing at a stepwise Michael/Friedel-Crafts domino mechanism for the Povarov reaction.³² One of the pieces of evidence that favours this conclusion is the trapping of the putative oxonium cation intermediate by nucleophiles; for instance, when the CAN-catalyzed reaction was performed in ethanol, compound **38** was isolated along with the Povarov product (Scheme 26).³¹

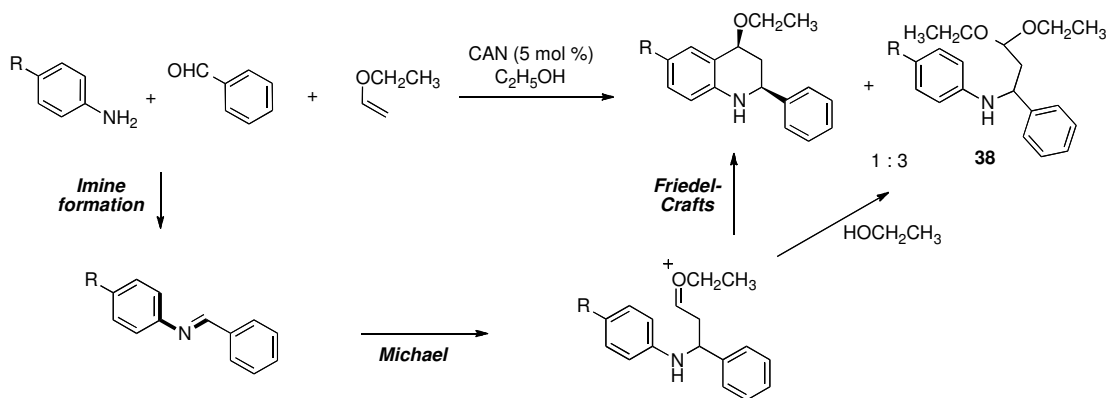

Vinylogous Povarov reactions are those that have as starting materials dienophiles or aldehydes having an additional double bond and have been classified accordingly as belonging to the types I or II (Scheme 27).³³ One recently described example of a type-II vinylogous Povarov reaction can be found in the CAN-catalyzed reaction between anilines, alkyl vinyl ethers and cinnamaldehyde derivatives, which allowed ready access to 2-styrylquinolines. This class of compounds is relevant because they have attracted much recent interest as inhibitors of HIV integrase.^{33,34}

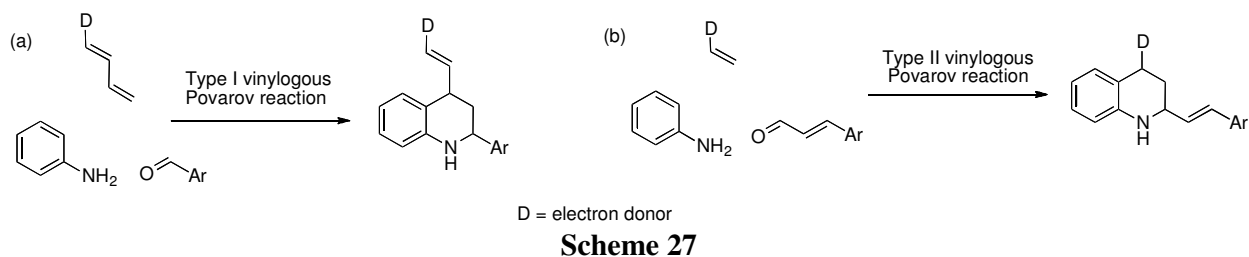

Regarding type-I reactions, we will mention the one between aromatic imines, and methacrolein dimethylhydrazone, in the presence of 10% indium trichloride, which furnished diastereoselectively the C-4 functionalized 1,2,3,4-tetrahydroquinolines in good to excellent yields (Scheme 28).³⁵ α,β -Unsaturated hydrazones have long been known to behave as the diene component in hetero Diels-Alder reactions leading to pyridine and fused pyridine derivatives and this is the first example of their use as the dienophile component, rather than the diene, in an imino Diels-Alder reaction.

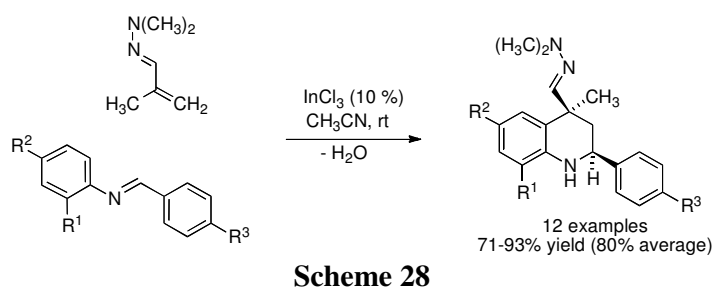

A final example of a Povarov-like domino process is summarized in Scheme 29 and involves the reaction between two equivalents of a vinyl ether and one of an aniline to give 2-methyl-4-alkoxy-1,2,3,4-tetrahydroquinolines.³⁶ The role of the vinyl ether in this mechanism is double and, for this reason, this reaction can be considered to belong to the ABB' chemodifferentiating class of multicomponent reactions, which are very promising in the generation of molecular diversity.³⁷

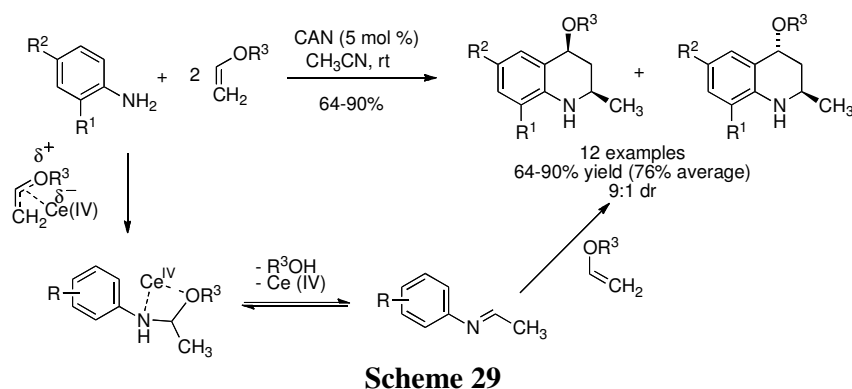

5. Knoevenagel-initiated domino reactions

It will be recalled that the reaction between bis(arylmethyl) sulfides, aldehydes and ammonium acetate in ethanol provides perhydro-1,4-thiazines (Scheme 8). The same reaction, under microwave-assisted conditions, took a completely different course and afforded thiazole derivatives **10**, presumably following the domino sequence summarized in Scheme 30.³⁸ The intermediacy of (*Z,Z*)-2,2'-thiobis(1,3-diarylprop-2-en-1-ones) **39** in the above transformation is demonstrated by their isolation as minor products (7–10%

yield) and their conversion into the thiazoles upon reaction with ammonium acetate under solvent-free microwave irradiation. The variation in the product selectivity from solution to solvent-free reaction may be probably explained by the solvation of transition states of different reactions, by the solvent molecules in solution reactions and by the reactant molecules in solvent-free reactions; as the polarity of solvent and reactants is different, they facilitate different reactions.

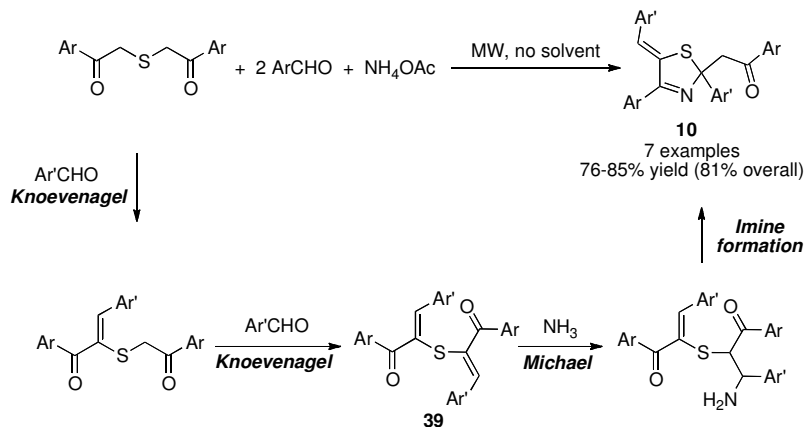

Another example of exquisite base-related product selectivity may be found in the reaction between ethyl acetoacetate, aromatic aldehydes and ammonia which, as previously mentioned, affords piperidone derivatives *via* a Mannich-Mannich sequence. The addition of L-proline increased the yield, although the products continued to be racemic. However, the use of pyrrolidine led to a different outcome, with cyclohexanones **40** as the main isolated products from a pseudo five-component reaction involving two molecules of the β -dicarbonyl compound and three of the aldehyde. Finally, replacement of the base by DBU afforded yet another product, namely compounds **41** (Scheme 31).³⁹ In the two latter cases, ammonia was also present in the reaction media but it was not incorporated into the final products.

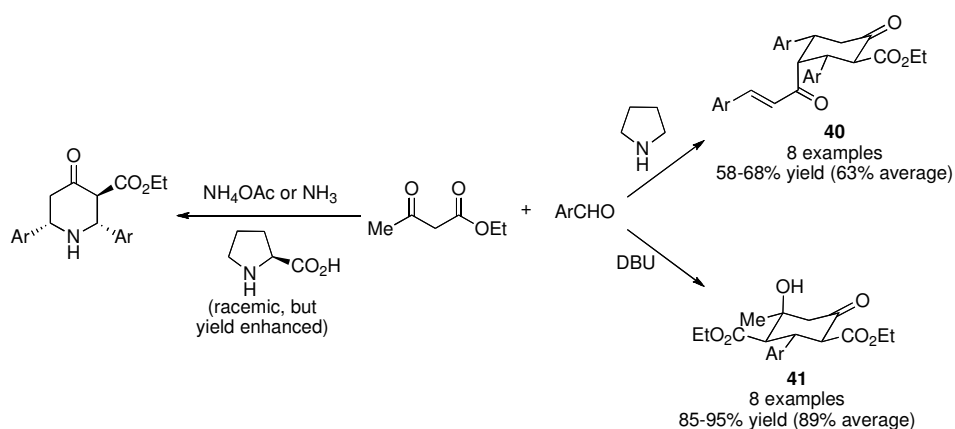

The mechanism leading to compounds **40** and **41** starts by a Knoevenagel-Michael sequence from two molecules of the dicarbonyl compound and one of the aldehyde, leading to intermediate **42**. In the presence of DBU, its cyclization by an intramolecular aldol reaction affords compounds **41**. On the other hand, in the presence of pyrrolidine, an enamine species is formed that prefers to react by an intermolecular aldol reaction with a molecule of the starting aldehyde. This process is repeated and the result is intermediate **43**,

which undergoes the final cyclization to **40** by a pyrrolidine-induced deethoxycarbonylation-Michael addition sequence (Scheme 32).

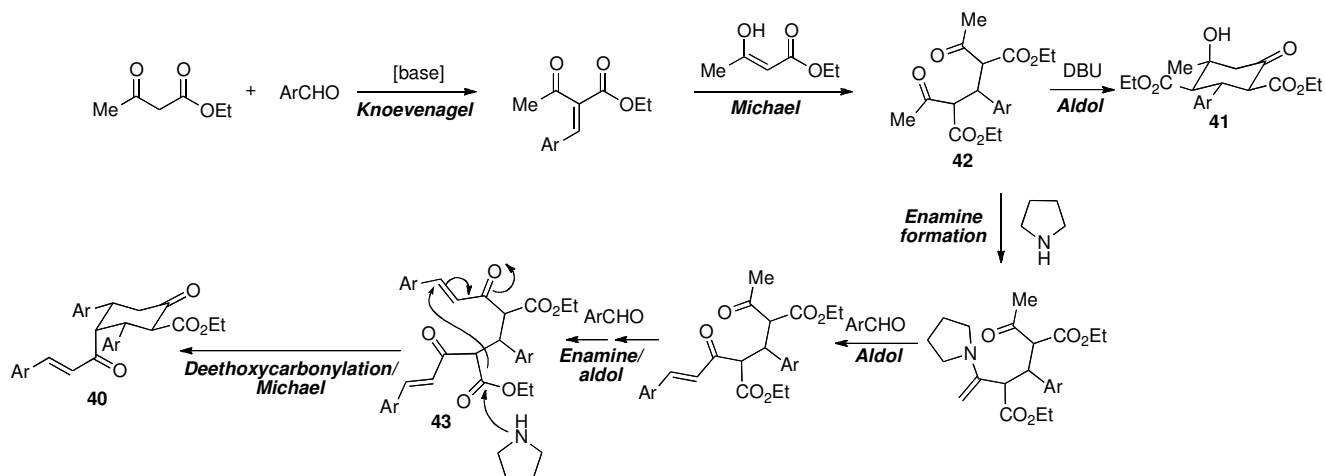

Scheme 32

As a final example of a Knoevenagel-initiated domino sequence leading to an heterocyclic system, we will mention an interesting reaction that affords 1,2,3,4-tetrahydroisoquinolines from 4-piperidones, malonodinitrile and nitrostyrenes as depicted in Scheme 33. The proposed mechanism involves a domino sequence initiated by the Knoevenagel condensation between the starting piperidone and malonodinitrile, followed by deprotonation and Michael addition onto the nitrostyrene. This generates a nitronate anion that undergoes a Thorpe-Ziegler cyclization to give the tetrahydroquinoline framework, followed by imine-enamine tautomerism and a final oxidation step promoted by air and presumably facilitated by the basic reaction conditions. One interesting feature of this reaction is its ability to afford a tetrahydro-isoquinoline derivative by generation of the benzene ring, which is a very unusual strategy for isoquinoline synthesis.⁴⁰

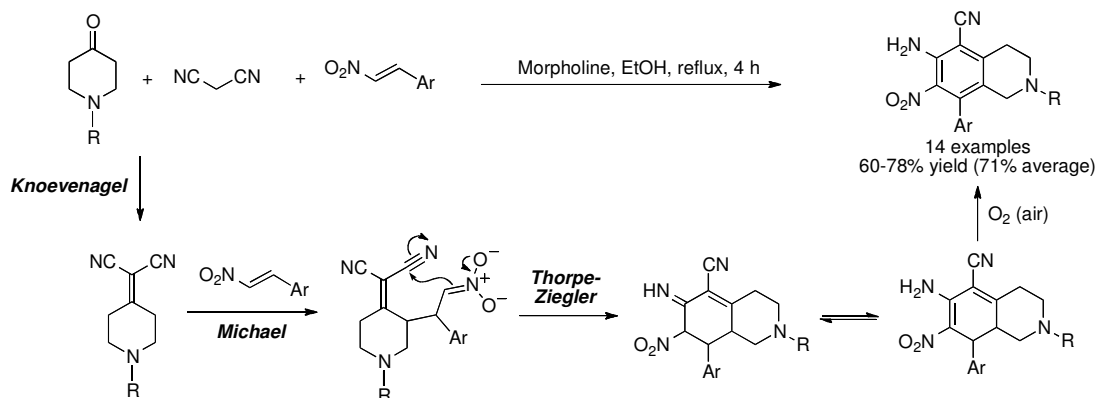

Scheme 33

6. Michael-initiated domino reactions

The hydroamination of alkenes or alkynes is a very important strategy for the synthesis of heterocyclic systems. In this context, a one-pot, four-component, domino reaction of phenylhydrazine, 3-amino-crotononitrile, cyclic 1,3-dicarbonyl compounds and substituted isatins or acenaphthylene-1,2-diones in water containing camphorsulfonic acid was recently employed for the construction of complex spiro-heterocyclic systems **44** and **45** comprising several interesting structural features such as spiro-oxindole,

pyrazole, pyrazolopyridine, pyridopyrimidine, pyrazolopyrido-pyrimidine and pyrazoloquinoline substructures (Scheme 34).⁴¹

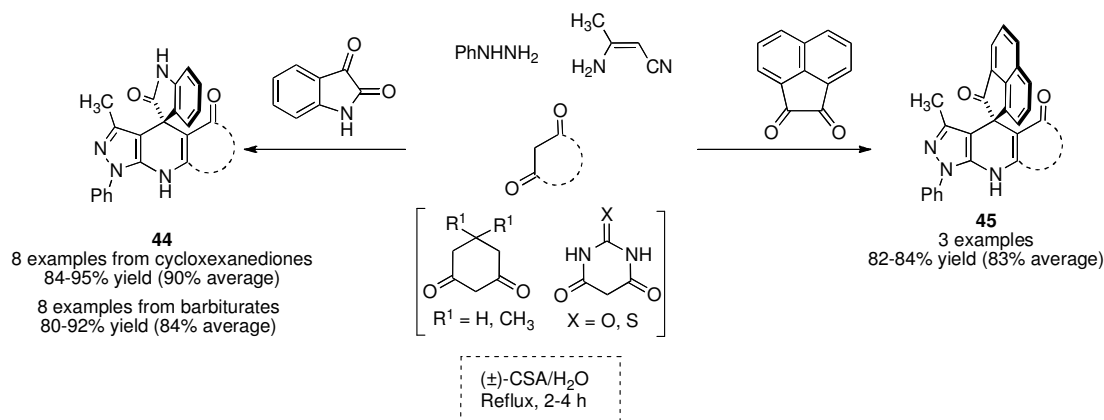

Scheme 34

A plausible mechanism for the formation of these spiroheterocycles is proposed in Scheme 35. The domino sequence of reactions is presumably triggered by the formation of 5-amino-3-methyl-1-phenylpyrazole **46** from the acid-catalyzed aza-Michael addition-elimination of phenylhydrazine with 3-amino-2-methylacrylonitrile. Intermediate **46**, acting as an enamine, reacts with isatin to afford the aldol adduct **47**, which was isolated as the sole reaction product in some of the reactions carried out during the optimization studies. This compound, upon reaction with the starting cyclic 1,3-diketones under acidic conditions, furnishes the final product.

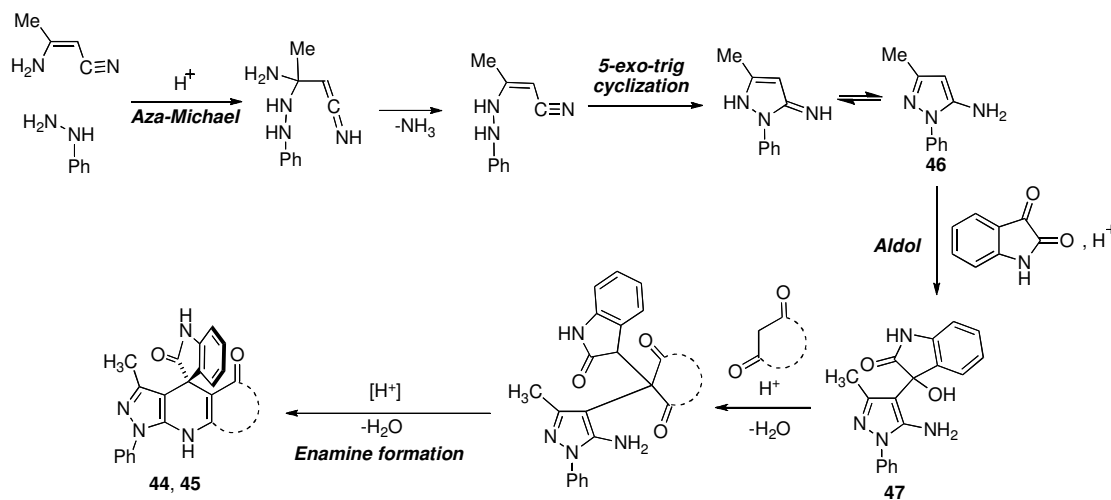

Scheme 35

7. Domino sequences including cycloaddition steps

The three-component reaction of 3,5-bisarylidene-4-piperidones, α -dicarbonyl compounds and α -amino acids afforded novel spiranic pyrido-pyrrolidines (or pyrrolizidines, in the reactions starting from proline) in chemo-, regio- and stereoselective fashion.⁴² Interestingly, these compounds, and also their deaza analogues obtained from diarylidencyclohexanones, showed excellent activity against *Mycobacterium tuberculosis*, including multidrug resistant strains.^{43,44} The reactions starting from *N*-unsubstituted piperidone derivatives involved the generation of an additional ring due to formation of a hemiaminal bond

between the piperidine nitrogen and the remaining carbonyl, leading to a cage-type final product and raising the number of adjacent stereocentres created to five if the nitrogen atom is also considered.⁴⁵ These transformations are summarized in Scheme 36 for sarcosine as the amino acid and acenaphthenequinone as the dicarbonyl component, affording compounds **47** or **48**.

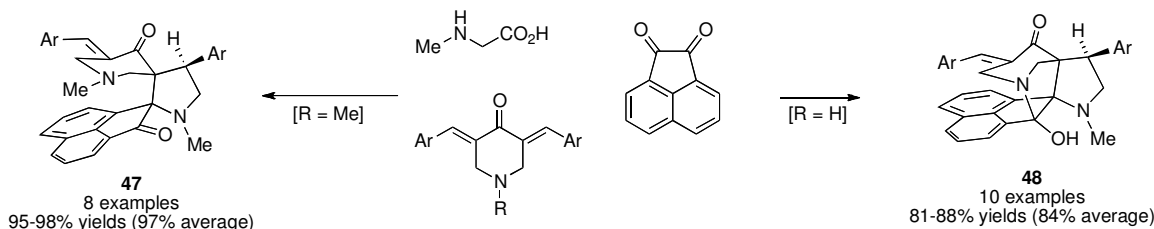

Scheme 36

As shown in Scheme 37, the reaction proceeds by the initial generation of a 1,3-dipolar intermediate from the amino acid. All these cycloadditions proceed chemoselectively, as they occur on only one C=C bond of the starting material owing to steric reasons. They also take place regioselectively, as the electron rich carbon of the dipole adds exclusively to the β -carbon of the α,β -unsaturated moiety of the starting material. Furthermore, there is a preferential attack of the nucleophilic carbon of the azomethine ylide to the end of the enone fragment of the bis-arylmethylenepiperidinone to give **49** instead of the alternative cycloaddition product **50**, which can be ascribed to steric reasons and also to the fact that, during the cycloaddition, a secondary orbital interaction between the nitrogen lone pair with the carbonyl function occurs, lowering the energy of activation for the cycloaddition and increasing the regioselectivity in favour of the observed products. Finally, the reactions were fully diastereoselective, as only one diastereomer was obtained, although multiple stereocentres are present in each product, and this can be explained by the existence of repulsive interactions in the transition state **51** leading to the alternative product.

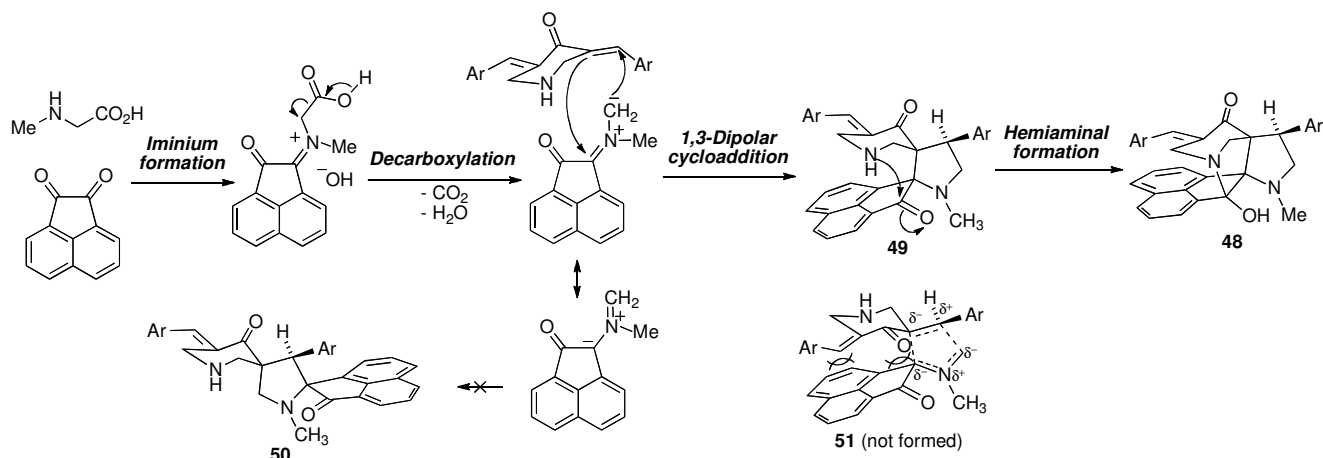

Scheme 37

Replacement of the dicarbonyl electrophile by nitrostyrenes led to an efficient route to simpler spiro-pyrrolidine derivatives, a few examples of which are shown in Scheme 38. These compounds also showed excellent activity as antitubercular agents.⁴⁶

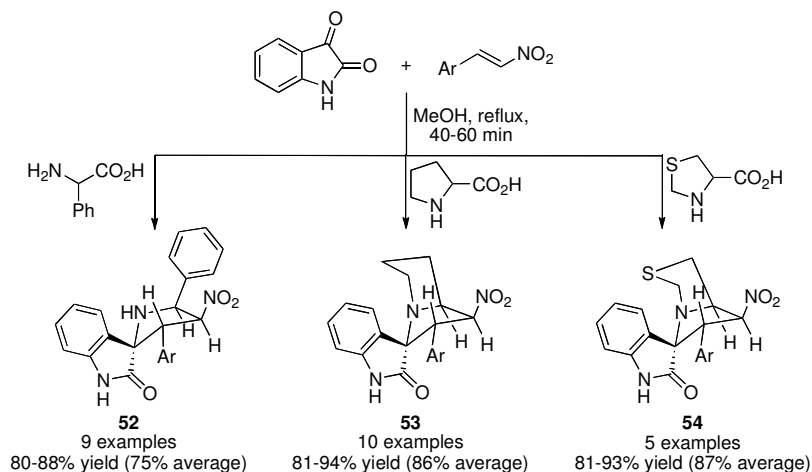

Scheme 38

8. Conclusion

Nowadays, the efficiency of a synthetic route is not only measured by traditional parameters such as yield and selectivity. More stringent requirements are often applied to characterize the ideal synthetic method, including the minimization of the consumption of chemicals (including raw materials, catalysts, solvents and chromatographic stationary phases), human resources and energy. From this point of view, domino reactions are particularly well suited to provide improved synthetic protocols and their development is rapidly becoming one of the frontiers of organic synthesis. Work on domino reactions has been focused mainly on the synthesis of libraries of potentially bioactive compounds, normally in the field of heterocycles and it is now approaching a high level of maturity, as witnessed by the examples chosen in this chapter. We hope that our necessarily brief commentary will stimulate the development of this fascinating and fast-growing area of study.

Acknowledgements

We thank MICINN, Spain and the Department of Science and Technology, New Delhi, for funding the Indo-Spanish collaborative major research projects that have made our joint work possible (grants No. DST/INT/SPAIN/09 and ACI2009-0956).

References

- For some recent general monographs that underscore the importance of heterocycles, see: (a) Pozharskii, A. F.; Soldatenkov, A. *Heterocycles in Life and Society: An Introduction to Heterocyclic Chemistry, Biochemistry and Applications*, 2nd Ed.; Wiley; 2011. (b) *Modern Heterocyclic Chemistry*; Álvarez-Builla, J.; Vaquero, J. J.; Barluenga, J., Eds; Wiley: Weinheim, 2011; Vols. 1–4.
- For selected general reviews on domino reactions, see: (a) Tietze, L. F. *Chem. Rev.* **1996**, *96*, 115. (b) Pellisier, H. *Tetrahedron* **2006**, *62*, 1619 and 2143. (c) Liéby-Muller, F.; Simon, C.; Constantieux, T.; Rodriguez, J. *QSAR Comb. Sci.* **2006**, *25*, 432. (d) Bur, S. K.; Padwa, A. *Adv. Heterocycl. Chem.* **2007**, *94*, 1. (e) Alba, A. N.; Companyó, X.; Viciano, M.; Ríos, R. *Curr. Org. Chem.* **2009**, *13*, 1432. (f) Tietze, L. F.; Levy, L. In *The Mizoroki-Heck Reaction*; Oestreich, M., Ed.; Wiley-VCH: Chichester, 2009; p. 281. (g) Tietze, L. F.; Düfert, A. In *Catalytic Asymmetric Conjugate Reactions*; Cordova, A., Ed.; Wiley-VCH: Weinheim, 2010; p. 321. (h) Grondal, C.; Jeanty, M.; Enders, D. *Nat. Chem.* **2010**, *2*, 167. (i) Bonne, D.; Coquerel, Y.; Constantieux, T.; Rodriguez, J. *Tetrahedron: Asymmetry* **2010**, *21*, 1085.
- (a) For a general overview of multiple bond-forming transformations as a key concept towards eco-compatible Organic Synthesis, see: Coquerel, Y.; Boddaert, T.; Presset, M.; Mailhol, D.; Rodriguez, J.

- In *Ideas in Chemistry and Molecular Sciences*; Pignataro, B., Ed.; Wiley-VCH: Weinheim, 2010; Vol. 1 (Advances in Synthetic Chemistry), Chapt. 9, p. 187. (b) See also the *Chemical Society Reviews* issue *On Rapid Formation of Molecular Complexity in Organic Synthesis: Chem. Soc. Rev.* **2009**, *38*, 2969–3276.
4. For an overview of the role of domino reactions in drug discovery, see: Lee, A.; Szewczyk, J. W.; Ellman, J. A. In *Stimulating Concepts in Chemistry*; Vögtle, F.; Fraser Stoddart, J.; Shibasaki, M., Eds.; Wiley-VCH: Weinheim, 2000; Chapt. 6.
 5. For a review, see: Nicolaou, K. C.; Edmonds, D. J.; Bulger, P. G. *Angew. Chem. Int. Ed.* **2006**, *45*, 7134.
 6. Savitha Devi, N.; Perumal, S. *Tetrahedron* **2006**, *62*, 5931.
 7. (a) Robinson, R. *J. Chem. Soc. Trans.* **1917**, *111*, 762. (b) Nicolaou, K. C.; Vourloumis, D.; Winssinger, N.; Baran, P. S. *Angew. Chem. Int. Ed.* **2001**, *39*, 44.
 8. Savitha Devi, N.; Perumal, S. *Tetrahedron Lett.* **2007**, *48*, 5627.
 9. Alex Raja, V. P.; Perumal, S. *Tetrahedron* **2006**, *62*, 4892.
 10. Reddy, D. B.; Reddy, M. M.; Reddy, P. V. R. *Indian J. Chem. Sect. B* **1993**, *32*, 1018.
 11. Indumathi, S.; Perumal, S.; Menéndez, J. C. *Tetrahedron* **2011**, *67*, 7101.
 12. Selvaraj, S.; Dhanabalan, A.; Mercypushphalatha, A.; Arumugam, N. *Phosphorus, Sulfur Silicon Relat. Elem.* **1991**, *63*, 295.
 13. Srinivasan, M.; Perumal, S. *Tetrahedron* **2007**, *63*, 2865.
 14. Sridharan, V.; Avendaño, C.; Menéndez, J. C. *Synlett* **2007**, 881.
 15. Sridharan, V.; Ribelles, P.; Ramos, M. T.; Menéndez, J. C. *J. Org. Chem.* **2009**, *74*, 5715.
 16. Kelly, T. R.; Chamberland, S.; Silva, R. A. *Tetrahedron Lett.* **1999**, *40*, 2723.
 17. For a review of the Nenitzescu reaction, see: Patil, S. A.; Ratil, R.; Miller, D. D. *Curr. Org. Chem.* **2008**, *12*, 691.
 18. Suryavanshi, P. A.; Sridharan, V.; Menéndez, J. C. *Org. Biomol. Chem.* **2010**, *8*, 3345.
 19. Sridharan, V.; Maiti, S.; Menéndez, J. C. *Chem. Eur. J.* **2009**, *15*, 4565.
 20. Sridharan, V.; Maiti, S.; Menéndez, J. C. *J. Org. Chem.* **2009**, *74*, 9365.
 21. Maiti, S.; Menéndez, J. C. *Synlett* **2009**, 2249.
 22. For a review, see: Isambert, N.; Lavilla, R. *Chem. Eur. J.* **2008**, *14*, 8444.
 23. Maiti, S.; Sridharan, V.; Menéndez, J. C. *J. Comb. Chem.* **2010**, *12*, 713.
 24. Maiti, S.; Menéndez, J. C. *Chem. Comm.* **2011**, *47*, 10554.
 25. Sridharan, V.; Perumal, P. T.; Avendaño, C.; Menéndez, J. C. *Tetrahedron* **2007**, *63*, 4407.
 26. Franke, P. T.; Johansen, R. L.; Bertelsen, S.; Jørgensen, K. A. *Chem. Asian J.* **2008**, *3*, 216.
 27. Kumar, A.; Awatar Maurya, R. *Tetrahedron* **2008**, *64*, 3477.
 28. (a) Yoshida, K.; Inokuma, T.; Takasu, K.; Takemoto, Y. *Synlett* **2010**, 1865. (b) Yoshida, K.; Inokuma, T.; Takasu, K.; Takemoto, Y. *Molecules* **2010**, *15*, 8305.
 29. For reviews of the Povarov reaction, see: (a) Glushkov, V. A.; Tolstikov, A. G. *Russ. Chem. Rev.* **2008**, *77*, 137. (b) Kouznetsov, V. V. *Tetrahedron* **2009**, *65*, 2721.
 30. For a review on the chemistry of tetrahydroquinolines, see: Sridharan, V.; Suryavanshi, P.; Menéndez, J. C. *Chem. Rev.* **2011**, *111*, 7157.
 31. (a) Sridharan, V.; Avendaño, C.; Menéndez, J. C. *Synthesis* **2008**, 1039. (b) Sridharan, V.; Avendaño, C.; Menéndez, J. C. *Synfacts* **2008**, 693.
 32. For a review emphasizing the mechanistic aspects of the Povarov reaction and containing also synthetic information, see: Bello, D.; Ramón, R.; Lavilla, R. *Curr. Org. Chem.* **2010**, *14*, 332.
 33. Sridharan, V.; Avendaño, C.; Menéndez, J. C. *Synlett* **2007**, 1079.
 34. Sridharan, V.; Avendaño, C.; Menéndez, J. C. *Tetrahedron* **2009**, *65*, 2087.
 35. (a) Sridharan, V.; Perumal, P. T.; Avendaño, C.; Menéndez, J. C. *Org. Biomol. Chem.* **2007**, *5*, 1351. (b) Sridharan, V.; Perumal, P. T.; Avendaño, C.; Menéndez, J. C. *Synfacts* **2007**, 688. (c) Sridharan, V.; Ribelles, P.; Estévez, V.; Villacampa, M.; Ramos, M. T.; Perumal, P. T.; Menéndez, J. C. *Chem. Eur. J.* **2012**, DOI: 10.1002/chem.201103562.
 36. (a) Sridharan, V.; Avendaño, C.; Menéndez, J. C. *Tetrahedron* **2007**, *63*, 673. (b) Sridharan, V.; Avendaño, C.; Menéndez, J. C. *Synfacts* **2007**, 478.
 37. For a review on this concept, see: Tejedor, D.; García-Tellado, F. *Chem. Soc. Rev.* **2007**, *36*, 484.
 38. Renuga, S.; Gnanadeebam, M.; Vinosha, B. M.; Perumal, S. *Tetrahedron* **2007**, *63*, 10054.

39. Srinivasan, M.; Perumal, S. *Tetrahedron* **2006**, *62*, 7726.
40. (a) Balamurugan, K.; Jeyachandran, V.; Perumal, S.; Menéndez, J. C. *Tetrahedron* **2011**, *67*, 1432. (b) Balamurugan, K.; Jeyachandran, V.; Perumal, S.; Menéndez, J. C. *Synfacts* **2011**, 363.
41. Balamurugan, K.; Perumal, S.; Menéndez, J. C. *Tetrahedron* **2011**, *67*, 3201.
42. Ranjith Kumar, R.; Perumal, S.; Senthilkumar, P.; Yogeewari, P.; Sriram, D. *Tetrahedron* **2008**, *64*, 2962.
43. Ranjith Kumar, R.; Perumal, S.; Senthilkumar, P.; Yogeewari, P.; Sriram, D. *J. Med. Chem.* **2008**, *51*, 5731.
44. Ranjith Kumar, R.; Perumal, S.; Manju, S. C.; Bhatt, P.; Yogeewari, P.; Sriram, D. *Bioorg. Med. Chem. Lett.* **2009**, *19*, 3461.
45. Suresh Kumar, R.; Osman, H.; Perumal, S.; Menéndez, J. C.; Ali, M. A.; Ismail, R.; Choon, T. C. *Tetrahedron* **2011**, *67*, 3132.
46. Rajesh, S. M.; Perumal, S.; Menéndez, J. C.; Yogeewari, P.; Sriram, D. *MedChemComm* **2011**, *2*, 626.